

SUTTER SUBBASIN

Groundwater Sustainability Plan

APPENDICES

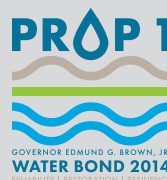

JANUARY 2022

This page intentionally left blank.

Appendix 1-A
DWR GSP Elements Guide

This page intentionally left blank.

Article 5. Plan Contents for Sutter Basin			GSP Document References				
			Page Numbers of Plan	Or Section Numbers	Or Figure Numbers	Or Table Numbers	Notes
§ 354.		Introduction to Plan Contents					
		This Article describes the required contents of Plans submitted to the Department for evaluation, including administrative information, a description of the basin setting, sustainable management criteria, description of the monitoring network, and projects and management actions.					
		Note: Authority cited: Section 10733.2, Water Code.					
		Reference: Section 10733.2, Water Code.					
SubArticle 1.		Administrative Information					
§ 354.2.		Introduction to Administrative Information					
		This Subarticle describes information in the Plan relating to administrative and other general information about the Agency that has adopted the Plan and the area covered by the Plan.					
		Note: Authority cited: Section 10733.2, Water Code.					
		Reference: Section 10733.2, Water Code.					
§ 354.4.		General Information					
		Each Plan shall include the following general information:					
(a)		An executive summary written in plain language that provides an overview of the Plan and description of groundwater conditions in the basin.	37:52	Executive Summary			
(b)		A list of references and technical studies relied upon by the Agency in developing the Plan. Each Agency shall provide to the Department electronic copies of reports and other documents and materials cited as references that are not generally available to the public.	669:682	9			
		Note: Authority cited: Section 10733.2, Water Code.					
		Reference: Sections 10733.2 and 10733.4, Water Code.					
§ 354.6.		Agency Information					
		When submitting an adopted Plan to the Department, the Agency shall include a copy of the information provided pursuant to Water Code Section 10723.8, with any updates, if necessary, along with the following information:					
(a)		The name and mailing address of the Agency.	149, 155	3.1		3-1	
(b)		The organization and management structure of the Agency, identifying persons with management authority for implementation of the Plan.	151:155, 157:158	3.2:3.3		3-1	Refer to Appendix 3-A submitted as Supporting Information.
(c)		The name and contact information, including the phone number, mailing address and electronic mail address, of the plan manager.	149	3.1			
(d)		The legal authority of the Agency, with specific reference to citations setting forth the duties, powers, and responsibilities of the Agency, demonstrating that the Agency has the legal authority to implement the Plan.	151:155, 157:158	3.2:3.3			
(e)		An estimate of the cost of implementing the Plan and a general description of how the Agency plans to meet those costs.	647:658	8.2		8-1:8-2	
		Note: Authority cited: Section 10733.2, Water Code.					
		Reference: Sections 10723.8, 10727.2, and 10733.2, Water Code.					
§ 354.8.		Description of Plan Area					

Article 5.

Plan Contents for Sutter Basin

			GSP Document References				Notes
			Page Numbers of Plan	Or Section Numbers	Or Figure Numbers	Or Table Numbers	
		Each Plan shall include a description of the geographic areas covered, including the following information:					
(a)		One or more maps of the basin that depict the following, as applicable:					
	(1)	The area covered by the Plan, delineating areas managed by the Agency as an exclusive Agency and any areas for which the Agency is not an exclusive Agency, and the name and location of any adjacent basins.	63, 65		2-1:2-2		All nine GSAs in the Sutter Subbin are exclusive GSAs.
	(2)	Adjudicated areas, other Agencies within the basin, and areas covered by an Alternative.	64:65	2.1.2	2-2		There are no adjudicated areas or areas covered by an Alternative Plan within the Sutter Subbasin.
	(3)	Jurisdictional boundaries of federal or state land (including the identity of the agency with jurisdiction over that land), tribal land, cities, counties, agencies with water management responsibilities, and areas covered by relevant general plans.	67:68, 70:71, 86		2-3:2-6, 2-15		
	(4)	Existing land use designations and the identification of water use sector and water source type.	82:84		2:12:2-14		
	(5)	The density of wells per square mile, by dasymetric or similar mapping techniques, showing the general distribution of agricultural, industrial, and domestic water supply wells in the basin, including de minimis extractors, and the location and extent of communities dependent upon groundwater, utilizing data provided by the Department, as specified in Section 353.2, or the best available information.	73:77		2-7:2-11		
(b)		A written description of the Plan area, including a summary of the jurisdictional areas and other features depicted on the map.	61:80	2.1			
(c)		Identification of existing water resource monitoring and management programs, and description of any such programs the Agency plans to incorporate in its monitoring network or in development of its Plan. The Agency may coordinate with existing water resource monitoring and management programs to incorporate and adopt that program as part of the Plan.	118:134	2.3			
(d)		A description of how existing water resource monitoring or management programs may limit operational flexibility in the basin, and how the Plan has been developed to adapt to those limits.	134	2.3.4			
(e)		A description of conjunctive use programs in the basin.	135:136	2.4			
(f)		A plain language description of the land use elements or topic categories of applicable general plans that includes the following:					
	(1)	A summary of general plans and other land use plans governing the basin.	85:113	2.2.1			
	(2)	A general description of how implementation of existing land use plans may change water demands within the basin or affect the ability of the Agency to achieve sustainable groundwater management over the planning and implementation horizon, and how the Plan addresses those potential effects	113:117	2.2.2			
	(3)	A general description of how implementation of the Plan may affect the water supply assumptions of relevant land use plans over the planning and implementation horizon.	113:117	2.2.2			

Article 5.

Plan Contents for Sutter Basin

GSP Document References

			Page Numbers of Plan	Or Section Numbers	Or Figure Numbers	Or Table Numbers	Notes
	(4)	A summary of the process for permitting new or replacement wells in the basin, including adopted standards in local well ordinances, zoning codes, and policies contained in adopted land use plans.	125:126	2.3.2			
	(5)	To the extent known, the Agency may include information regarding the implementation of land use plans outside the basin that could affect the ability of the Agency to achieve sustainable groundwater management.	116:117	2.2.2.4			
(g)		A description of any of the additional Plan elements included in Water Code Section 10727.4 that the Agency determines to be appropriate.	137:138	2.5			
		Note: Authority cited: Section 10733.2, Water Code.					
		Reference: Sections 10720.3, 10727.2, 10727.4, 10733, and 10733.2, Water Code.					
§ 354.10. Notice and Communication							
		Each Plan shall include a summary of information relating to notification and communication by the Agency with other agencies and interested parties including the following:					
(a)		A description of the beneficial uses and users of groundwater in the basin, including the land uses and property interests potentially affected by the use of groundwater in the basin, the types of parties representing those interests, and the nature of consultation with those parties.	163:174	4.1	4-1:4-4	4-1:4-4	
(b)		A list of public meetings at which the Plan was discussed or considered by the Agency.	183:184	4.3.2.1		4-7	
(c)		Comments regarding the Plan received by the Agency and a summary of any responses by the Agency.	177	4.2.2		4-5	Comments and comment letters are compiled and included in Appendix 4-C (submitted as Supporting Information).
(d)		A communication section of the Plan that includes the following:					
	(1)	An explanation of the Agency's decision-making process.	175:177	4.2.1			
	(2)	Identification of opportunities for public engagement and a discussion of how public input and response will be used.	177:186	4.3			
	(3)	A description of how the Agency encourages the active involvement of diverse social, cultural, and economic elements of the population within the basin.	185	4.3.3			
	(4)	The method the Agency shall follow to inform the public about progress implementing the Plan, including the status of projects and actions.	183:186, 659, 663:665	4.3.2.1, 4.3.4, 8.4, 8.9.3, 8.10			
		Note: Authority cited: Section 10733.2, Water Code.					
		Reference: Sections 10723.2, 10727.8, 10728.4, and 10733.2, Water Code					
SubArticle 2. Basin Setting							
§ 354.12. Introduction to Basin Setting							

Article 5.

Plan Contents for Sutter Basin

GSP Document References

			Page Numbers of Plan	Or Section Numbers	Or Figure Numbers	Or Table Numbers	Notes
		This Subarticle describes the information about the physical setting and characteristics of the basin and current conditions of the basin that shall be part of each Plan, including the identification of data gaps and levels of uncertainty, which comprise the basin setting that serves as the basis for defining and assessing reasonable sustainable management criteria and projects and management actions. Information provided pursuant to this Subarticle shall be prepared by or under the direction of a professional geologist or professional engineer.					
		Note: Authority cited: Section 10733.2, Water Code.					
		Reference: Section 10733.2, Water Code.					
§ 354.14.							
Hydrogeologic Conceptual Model							
(a)		Each Plan shall include a descriptive hydrogeologic conceptual model of the basin based on technical studies and qualified maps that characterizes the physical components and interaction of the surface water and groundwater systems in the basin.	191:302	5.1			
(b)		The hydrogeologic conceptual model shall be summarized in a written description that includes the following:					
	(1)	The regional geologic and structural setting of the basin including the immediate surrounding area, as necessary for geologic consistency.	192:201	5.1.1			
	(2)	Lateral basin boundaries, including major geologic features that significantly affect groundwater flow.	202	5.1.2			
	(3)	The definable bottom of the basin.	202:203	5.1.3			
	(4)	Principal aquifers and aquitards, including the following information:					
	(A)	Formation names, if defined.	204:210, 218	5.1.4, 5.1.6.1			
	(B)	Physical properties of aquifers and aquitards, including the vertical and lateral extent, hydraulic conductivity, and storativity, which may be based on existing technical studies or other best available information.	221, 223, 238:240	5.1.6.3	5-12:5-13	5-1:5-3	
	(C)	Structural properties of the basin that restrict groundwater flow within the principal aquifers, including information regarding stratigraphic changes, truncation of units, or other features.	218:238	5.1.6.2			
	(D)	General water quality of the principal aquifers, which may be based on information derived from existing technical studies or regulatory programs.	245, 247:295	5.1.9			
	(E)	Identification of the primary use or uses of each aquifer, such as domestic, irrigation, or municipal water supply.	72	2.1.3.1			
	(5)	Identification of data gaps and uncertainty within the hydrogeologic conceptual model	299:302	5.1.12			
(c)		The hydrogeologic conceptual model shall be represented graphically by at least two scaled cross-sections that display the information required by this section and are sufficient to depict major stratigraphic and structural features in the basin.	205, 213:217		5-6, 5-8:5-11		

Article 5.

Plan Contents for Sutter Basin

GSP Document References

			Page Numbers of Plan	Or Section Numbers	Or Figure Numbers	Or Table Numbers	Notes
(d)		Physical characteristics of the basin shall be represented on one or more maps that depict the following:					
	(1)	Topographic information derived from the U.S. Geological Survey or another reliable source.	199:200	5.1.1.1	5-3		
	(2)	Surficial geology derived from a qualified map including the locations of cross-sections required by this Section.	192:195, 205	5.1.1	5-1, 5-6		
	(3)	Soil characteristics as described by the appropriate Natural Resources Conservation Service soil survey or other applicable studies.	199, 201	5.1.1.2	5-4		
	(4)	Delineation of existing recharge areas that substantially contribute to the replenishment of the basin, potential recharge areas, and discharge areas, including significant active springs, seeps, and wetlands within or adjacent to the basin.	240:246	5.1.7:5.1.8	5-24:5-26		
	(5)	Surface water bodies that are significant to the management of the basin.	63, 297	5.1.10	2-1		
	(6)	The source and point of delivery for imported water supplies.	297:298	5.1.11	5-48		
		Note: Authority cited: Section 10733.2, Water Code.					
		Reference: Sections 10727.2, 10733, and 10733.2, Water Code.					
§ 354.16.		Groundwater Conditions					
		Each Plan shall provide a description of current and historical groundwater conditions in the basin, including data from January 1, 2015, to current conditions, based on the best available information that includes the following:					
(a)		Groundwater elevation data demonstrating flow directions, lateral and vertical gradients, and regional pumping patterns, including:					
	(1)	Groundwater elevation contour maps depicting the groundwater table or potentiometric surface associated with the current seasonal high and seasonal low for each principal aquifer within the basin.	329:337	5.2.2.2	5-69:5-76		
	(2)	Hydrographs depicting long-term groundwater elevations, historical highs and lows, and hydraulic gradients between principal aquifers.	317:327	5.2.2.1	5-59:5-68		
(b)		A graph depicting estimates of the change in groundwater in storage, based on data, demonstrating the annual and cumulative change in the volume of groundwater in storage between seasonal high groundwater conditions, including the annual groundwater use and water year type.	344:345	5.2.3	5-81		
(c)		Seawater intrusion conditions in the basin, including maps and cross-sections of the seawater intrusion front for each principal aquifer.	345	5.2.4			Seawater intrusion is not an applicable sustainability indicator for the Sutter Subbasin as the Subbasin is located inland from the Pacific Ocean and is not adjacent to the Sacramento-San Joaquin Delta.
(d)		Groundwater quality issues that may affect the supply and beneficial uses of groundwater, including a description and map of the location of known groundwater contamination sites and plumes.	291:295, 345:354	5.1.9.7, 5.2.5	5-47, 5-82:5-86	5-6:5-7	
(e)		The extent, cumulative total, and annual rate of land subsidence, including maps depicting total subsidence, utilizing data available from the Department, as specified in Section 353.2, or the best available information.	354:358	5.2.6	5-87:5-89	5-8	

Article 5.

Plan Contents for Sutter Basin

GSP Document References

			Page Numbers of Plan	Or Section Numbers	Or Figure Numbers	Or Table Numbers	Notes
(f)		Identification of interconnected surface water systems within the basin and an estimate of the quantity and timing of depletions of those systems, utilizing data available from the Department, as specified in Section 353.2, or the best available information.	359:362	5.2.7	5-91:5-92	5-9	
(g)		Identification of groundwater dependent ecosystems within the basin, utilizing data available from the Department, as specified in Section 353.2, or the best available information.	363:373	5.2.8	5-93:5-98	5-10	
		Note: Authority cited: Section 10733.2, Water Code.					
		Reference: Sections 10723.2, 10727.2, 10727.4, and 10733.2, Water Code.					
§ 354.18. Water Budget							
(a)		Each Plan shall include a water budget for the basin that provides an accounting and assessment of the total annual volume of groundwater and surface water entering and leaving the basin, including historical, current and projected water budget conditions, and the change in the volume of water stored. Water budget information shall be reported in tabular and graphical form.	375:404	5.3			
(b)		The water budget shall quantify the following, either through direct measurements or estimates based on data:					
	(1)	Total surface water entering and leaving a basin by water source type.	384:403	5.3.5	5-101:5-102, 5-105:5-110	5-12:5-14	
	(2)	Inflow to the groundwater system by water source type, including subsurface groundwater inflow and infiltration of precipitation, applied water, and surface water systems, such as lakes, streams, rivers, canals, springs and conveyance systems.	384:403	5.3.5	5-101:5-102, 5-105:5-110	5-12:5-14	
	(3)	Outflows from the groundwater system by water use sector, including evapotranspiration, groundwater extraction, groundwater discharge to surface water sources, and subsurface groundwater outflow.	384:403	5.3.5	5-101:5-102, 5-105:5-110	5-12:5-14	
	(4)	The change in the annual volume of groundwater in storage between seasonal high conditions.	344:345, 391, 396		5-81, 5-104		
	(5)	If overdraft conditions occur, as defined in Bulletin 118, the water budget shall include a quantification of overdraft over a period of years during which water year and water supply conditions approximate average conditions.	N/A				Overdraft conditions have not historically occurred and are not projected to occur in the Sutter Subbasin, based on best available data at the time of writing the GSP.
	(6)	The water year type associated with the annual supply, demand, and change in groundwater stored.	344:345 , 376:378, 391, 395:396	5.2.3, 5.3.2	5-103:5-104		
	(7)	An estimate of sustainable yield for the basin.	404	5.3.6			
(c)		Each Plan shall quantify the current, historical, and projected water budget for the basin as follows:					

Article 5.

Plan Contents for Sutter Basin

				GSP Document References				Notes
				Page Numbers of Plan	Or Section Numbers	Or Figure Numbers	Or Table Numbers	
	(1)	Current water budget information shall quantify current inflows and outflows for the basin using the most recent hydrology, water supply, water demand, and land use information.		379:382, 384:388, 393, 396:398	5.3.4.2, 5.3.5.2	5-105:5-106	5-11:5-14	
	(2)	Historical water budget information shall be used to evaluate availability or reliability of past surface water supply deliveries and aquifer response to water supply and demand trends relative to water year type. The historical water budget shall include the following:						
	(A)	A quantitative evaluation of the availability or reliability of historical surface water supply deliveries as a function of the historical planned versus actual annual surface water deliveries, by surface water source and water year type, and based on the most recent ten years of surface water supply information.		379:381, 384:396	5.3.4.1, 5.3.5.1	5-101:5-104	5-11:5-14	
	(B)	A quantitative assessment of the historical water budget, starting with the most recently available information and extending back a minimum of 10 years, or as is sufficient to calibrate and reduce the uncertainty of the tools and methods used to estimate and project future water budget information and future aquifer response to proposed sustainable groundwater management practices over the planning and implementation horizon.		379:381, 384:396	5.3.4.1, 5.3.5.1	5-101:5-104	5-11:5-14	
	(C)	A description of how historical conditions concerning hydrology, water demand, and surface water supply availability or reliability have impacted the ability of the Agency to operate the basin within sustainable yield. Basin hydrology may be characterized and evaluated using water year type.		376:378, 389:391	5.3.2, 5.3.5.1	5-100:5-104		
	(3)	Projected water budgets shall be used to estimate future baseline conditions of supply, demand, and aquifer response to Plan implementation, and to identify the uncertainties of these projected water budget components. The projected water budget shall utilize the following methodologies and assumptions to estimate future baseline conditions concerning hydrology, water demand and surface water supply availability or reliability over the planning and implementation horizon:						
	(A)	Projected hydrology shall utilize 50 years of historical precipitation, evapotranspiration, and streamflow information as the baseline condition for estimating future hydrology. The projected hydrology information shall also be applied as the baseline condition used to evaluate future scenarios of hydrologic uncertainty associated with projections of climate change and sea level rise.		378:379, 382:384, 398:403	5.3.3, 5.3.4.3, 5.3.4.4, 5.3.5.3	5-107:5-110	5-11:5-14	
	(B)	Projected water demand shall utilize the most recent land use, evapotranspiration, and crop coefficient information as the baseline condition for estimating future water demand. The projected water demand information shall also be applied as the baseline condition used to evaluate future scenarios of water demand uncertainty associated with projected changes in local land use planning, population growth, and climate.		376:380, 382:388, 398:403	5.3.3, 5.3.4.3, 5.3.4.4, 5.3.5.3	5-107:5-110	5-11:5-14	Refer to Appendix 5-H: Projected Water Budget Climate Change Methodology for more information (submitted as Supporting Information).

Article 5.

Plan Contents for Sutter Basin

			GSP Document References				Notes
			Page Numbers of Plan	Or Section Numbers	Or Figure Numbers	Or Table Numbers	
	(C)	Projected surface water supply shall utilize the most recent water supply information as the baseline condition for estimating future surface water supply. The projected surface water supply shall also be applied as the baseline condition used to evaluate future scenarios of surface water supply availability and reliability as a function of the historical surface water supply identified in Section 354.18(c)(2)(A), and the projected changes in local land use planning, population growth, and climate.	376:380, 382:388, 398:403	5.3.3, 5.3.4.3, 5.3.4.4, 5.3.5.3	5-107:5-110	5-11:5-14	
(d)		The Agency shall utilize the following information provided, as available, by the Department pursuant to Section 353.2, or other data of comparable quality, to develop the water budget:					
	(1)	Historical water budget information for mean annual temperature, mean annual precipitation, water year type, and land use.	375:381	5.3.1:5.3.3, 5.3.4.1			
	(2)	Current water budget information for temperature, water year type, evapotranspiration, and land use.	375:382	5.3.1:5.3.3, 5.3.4.2			
	(3)	Projected water budget information for population, population growth, climate change, and sea level rise.	375:380, 382:384	5.3.4.3:5.3.4.4			
(e)		Each Plan shall rely on the best available information and best available science to quantify the water budget for the basin in order to provide an understanding of historical and projected hydrology, water demand, water supply, land use, population, climate change, sea level rise, groundwater and surface water interaction, and subsurface groundwater flow. If a numerical groundwater and surface water model is not used to quantify and evaluate the projected water budget conditions and the potential impacts to beneficial uses and users of groundwater, the Plan shall identify and describe an equally effective method, tool, or analytical model to evaluate projected water budget conditions.	375:384	5.3.1:5.3.4			A numerical groundwater and surface water model was used. Refer to Appendix 5-G: C2VSimFG-Sutter Model Report (submitted as Supporting Information).
(f)		The Department shall provide the California Central Valley Groundwater-Surface Water Simulation Model (C2VSIM) and the Integrated Water Flow Model (IWFm) for use by Agencies in developing the water budget. Each Agency may choose to use a different groundwater and surface water model, pursuant to Section 352.4.	375:385	5.3.1:5.3.4			An IWFm-based model was used in the GSP, C2VSimFG-Sutter. Refer to Appendix 5-G: C2VSimFG-Sutter Model Report (submitted as Supporting Information).
		Note: Authority cited: Section 10733.2, Water Code.					
		Reference: Sections 10721, 10723.2, 10727.2, 10727.6, 10729, and 10733.2, Water Code.					
§ 354.20. Management Areas							
(a)		Each Agency may define one or more management areas within a basin if the Agency has determined that creation of management areas will facilitate implementation of the Plan. Management areas may define different minimum thresholds and be operated to different measurable objectives than the basin at large, provided that undesirable results are defined consistently throughout the basin.	N/A				No management areas are defined within the Sutter Subbasin.
(b)		A basin that includes one or more management areas shall describe the following in the Plan:					

Article 5.

Plan Contents for Sutter Basin

GSP Document References

			Page Numbers of Plan	Or Section Numbers	Or Figure Numbers	Or Table Numbers	Notes
	(1)	The reason for the creation of each management area.	N/A				No management areas are defined within the Sutter Subbasin.
	(2)	The minimum thresholds and measurable objectives established for each management area, and an explanation of the rationale for selecting those values, if different from the basin at large.	N/A				No management areas are defined within the Sutter Subbasin.
	(3)	The level of monitoring and analysis appropriate for each management area.	N/A				No management areas are defined within the Sutter Subbasin.
	(4)	An explanation of how the management area can operate under different minimum thresholds and measurable objectives without causing undesirable results outside the management area, if applicable.	N/A				No management areas are defined within the Sutter Subbasin.
(c)		If a Plan includes one or more management areas, the Plan shall include descriptions, maps, and other information required by this Subarticle sufficient to describe conditions in those areas.	N/A				No management areas are defined within the Sutter Subbasin.
		Note: Authority cited: Section 10733.2, Water Code.					
		Reference: Sections 10733.2 and 10733.4, Water Code.					
SubArticle 3.		Sustainable Management Criteria					
§ 354.22.		Introduction to Sustainable Management Criteria					
		This Subarticle describes criteria by which an Agency defines conditions in its Plan that constitute sustainable groundwater management for the basin, including the process by which the Agency shall characterize undesirable results, and establish minimum thresholds and measurable objectives for each applicable sustainability indicator.					
		Note: Authority cited: Section 10733.2, Water Code.					
		Reference: Section 10733.2, Water Code.					
§ 354.24.		Sustainability Goal					
		Each Agency shall establish in its Plan a sustainability goal for the basin that culminates in the absence of undesirable results within 20 years of the applicable statutory deadline. The Plan shall include a description of the sustainability goal, including information from the basin setting used to establish the sustainability goal, a discussion of the measures that will be implemented to ensure that the basin will be operated within its sustainable yield, and an explanation of how the sustainability goal is likely to be achieved within 20 years of Plan implementation and is likely to be maintained through the planning and implementation horizon.	413:414	6.3			
		Note: Authority cited: Section 10733.2, Water Code.					
		Reference: Sections 10721, 10727, 10727.2, 10733.2, and 10733.8, Water Code.					
§ 354.26.		Undesirable Results					
(a)		Each Agency shall describe in its Plan the processes and criteria relied upon to define undesirable results applicable to the basin. Undesirable results occur when significant and unreasonable effects for any of the sustainability indicators are caused by groundwater conditions occurring throughout the basin.	414:421	6.4			
(b)		The description of undesirable results shall include the following:					

Article 5.

Plan Contents for Sutter Basin

			GSP Document References				Notes
			Page Numbers of Plan	Or Section Numbers	Or Figure Numbers	Or Table Numbers	
(1)		The cause of groundwater conditions occurring throughout the basin that would lead to or has led to undesirable results based on information described in the basin setting, and other data or models as appropriate.	415:421	6.4.1.3, 6.4.2.2, 6.4.4.3, 6.4.5.3, 6.4.6.3			
(2)		The criteria used to define when and where the effects of the groundwater conditions cause undesirable results for each applicable sustainability indicator. The criteria shall be based on a quantitative description of the combination of minimum threshold exceedances that cause significant and unreasonable effects in the basin.	415:421	6.4.1.2, 6.4.2.1, 6.4.4.1:6.4.4.2, 6.4.5.1:6.4.5.2, 6.4.6.1:6.4.6.2			Refer to Appendix 6-B: Sustainable Management Criteria for Chronic Lowering of Groundwater Levels Methodology Technical Memorandum (submitted as Supporting Information).
(3)		Potential effects on the beneficial uses and users of groundwater, on land uses and property interests, and other potential effects that may occur or are occurring from undesirable results.	416:417, 419:421	6.4.1.4, 6.4.2.3, 6.4.4.4, 6.4.5.4, 6.4.6.4			
(c)		The Agency may need to evaluate multiple minimum thresholds to determine whether an undesirable result is occurring in the basin. The determination that undesirable results are occurring may depend upon measurements from multiple monitoring sites, rather than a single monitoring site.	415:421	6.4.1.2, 6.4.2.1, 6.4.4.1:6.4.4.2, 4.2, 6.4.5.1:6.4.5.2, 6.4.6.1:6.4.6.2			Refer to Appendix 6-B: Sustainable Management Criteria for Chronic Lowering of Groundwater Levels Methodology Technical Memorandum (submitted as Supporting Information).
(d)		An Agency that is able to demonstrate that undesirable results related to one or more sustainability indicators are not present and are not likely to occur in a basin shall not be required to establish criteria for undesirable results related to those sustainability indicators.	417	6.4.3			Seawater intrusion is not an applicable sustainability indicator for the Sutter Subbasin as the Subbasin is located inland from the Pacific Ocean and is not adjacent to the Sacramento-San Joaquin Delta.
		Note: Authority cited: Section 10733.2, Water Code.					
		Reference: Sections 10721, 10723.2, 10727.2, 10733.2, and 10733.8, Water Code.					
§ 354.28. Minimum Thresholds							
(a)		Each Agency in its Plan shall establish minimum thresholds that quantify groundwater conditions for each applicable sustainability indicator at each monitoring site or representative monitoring site established pursuant to Section 354.36. The numeric value used to define minimum thresholds shall represent a point in the basin that, if exceeded, may cause undesirable results as described in Section 354.26.	421:457	6.5		6-1:6-4	
(b)		The description of minimum thresholds shall include the following:					

Article 5. Plan Contents for Sutter Basin

				GSP Document References				Notes
				Page Numbers of Plan	Or Section Numbers	Or Figure Numbers	Or Table Numbers	
	(1)	The information and criteria relied upon to establish and justify the minimum thresholds for each sustainability indicator. The justification for the minimum threshold shall be supported by information provided in the basin setting, and other data or models as appropriate, and qualified by uncertainty in the understanding of the basin setting.	422:427, 433:436, 441:442, 446:451	6.5.1.1, 6.5.2, 6.5.4.1, 6.5.5.1, 6.5.6.1				
	(2)	The relationship between the minimum thresholds for each sustainability indicator, including an explanation of how the Agency has determined that basin conditions at each minimum threshold will avoid undesirable results for each of the sustainability indicators.	427:428, 433, 437, 442:443, 451:452	6.5.1.2, 6.5.2, 6.5.4.2, 6.5.5.2, 6.5.6.2				
	(3)	How minimum thresholds have been selected to avoid causing undesirable results in adjacent basins or affecting the ability of adjacent basins to achieve sustainability goals.	428:431, 433, 437:439, 443:445, 452:455	6.5.1.3, 6.5.2, 6.5.4.3, 6.5.5.3, 6.5.6.3				
	(4)	How minimum thresholds may affect the interests of beneficial uses and users of groundwater or land uses and property interests.	431:433, 439:441, 445:446, 455:456	6.5.1.4, 6.5.2, 6.5.4.4, 6.5.5.4, 6.5.6.4				
	(5)	How state, federal, or local standards relate to the relevant sustainability indicator. If the minimum threshold differs from other regulatory standards, the Agency shall explain the nature of and basis for the difference.	432:433, 441, 446, 456:457	6.5.1.5, 6.5.2, 6.5.4.5, 6.5.5.5, 6.5.6.5				
	(6)	How each minimum threshold will be quantitatively measured, consistent with the monitoring network requirements described in Subarticle 4.	433, 441, 446, 457, 602:604, 606, 614:618, 624:626, 635:637	6.5.1.6, 6.5.2, 6.5.4.6, 6.5.5.6, 6.5.6.6, 7.2.6.1.4, 7.2.6.2, 7.2.6.4.4, 7.2.6.5.4, 7.2.6.6.4				
(c)		Minimum thresholds for each sustainability indicator shall be defined as follows:						
	(1)	Chronic Lowering of Groundwater Levels. The minimum threshold for chronic lowering of groundwater levels shall be the groundwater elevation indicating a depletion of supply at a given location that may lead to undesirable results. Minimum thresholds for chronic lowering of groundwater levels shall be supported by the following:						
	(A)	The rate of groundwater elevation decline based on historical trends, water year type, and projected water use in the basin.	304:327, 398:403, 422:433	5.2.2.1, 5.3.5.3:5.3.5.4, 5.4, 6.5.1				

Article 5.

Plan Contents for Sutter Basin

			GSP Document References				Notes
			Page Numbers of Plan	Or Section Numbers	Or Figure Numbers	Or Table Numbers	
	(B)	Potential effects on other sustainability indicators.	427:428	6.5.1.2			
(2)		Reduction of Groundwater Storage. The minimum threshold for reduction of groundwater storage shall be a total volume of groundwater that can be withdrawn from the basin without causing conditions that may lead to undesirable results. Minimum thresholds for reduction of groundwater storage shall be supported by the sustainable yield of the basin, calculated based on historical trends, water year type, and projected water use in the basin.	433	6.5.2			
(3)		Seawater Intrusion. The minimum threshold for seawater intrusion shall be defined by a chloride concentration isocontour for each principal aquifer where seawater intrusion may lead to undesirable results. Minimum thresholds for seawater intrusion shall be supported by the following:					
(A)		Maps and cross-sections of the chloride concentration isocontour that defines the minimum threshold and measurable objective for each principal aquifer.	N/A				Seawater intrusion is not an applicable sustainability indicator for the Sutter Subbasin as the Subbasin is located inland from the Pacific Ocean and is not adjacent to the Sacramento-San Joaquin Delta.
(B)		A description of how the seawater intrusion minimum threshold considers the effects of current and projected sea levels.	N/A				Seawater intrusion is not an applicable sustainability indicator for the Sutter Subbasin as the Subbasin is located inland from the Pacific Ocean and is not adjacent to the Sacramento-San Joaquin Delta.
(4)		Degraded Water Quality. The minimum threshold for degraded water quality shall be the degradation of water quality, including the migration of contaminant plumes that impair water supplies or other indicator of water quality as determined by the Agency that may lead to undesirable results. The minimum threshold shall be based on the number of supply wells, a volume of water, or a location of an isocontour that exceeds concentrations of constituents determined by the Agency to be of concern for the basin. In setting minimum thresholds for degraded water quality, the Agency shall consider local, state, and federal water quality standards applicable to the basin.	245:295, 345:354, 434:441	5.1.9, 5.2.5, 6.5.4			
(5)		Land Subsidence. The minimum threshold for land subsidence shall be the rate and extent of subsidence that substantially interferes with surface land uses and may lead to undesirable results. Minimum thresholds for land subsidence shall be supported by the following:					
(A)		Identification of land uses and property interests that have been affected or are likely to be affected by land subsidence in the basin, including an explanation of how the Agency has determined and considered those uses and interests, and the Agency’s rationale for establishing minimum thresholds in light of those effects.	441:446	6.5.5			
(B)		Maps and graphs showing the extent and rate of land subsidence in the basin that defines the minimum threshold and measurable objectives.	354:358		5-88:5-89		

Article 5.

Plan Contents for Sutter Basin

GSP Document References

			Page Numbers of Plan	Or Section Numbers	Or Figure Numbers	Or Table Numbers	Notes
(6)		Depletions of Interconnected Surface Water. The minimum threshold for depletions of interconnected surface water shall be the rate or volume of surface water depletions caused by groundwater use that has adverse impacts on beneficial uses of the surface water and may lead to undesirable results. The minimum threshold established for depletions of interconnected surface water shall be supported by the following:					
	(A)	The location, quantity, and timing of depletions of interconnected surface water.	359:362, 446:457	5.2.7, 6.5.6	5-91:5-92	5-9, 6-4	
	(B)	A description of the groundwater and surface water model used to quantify surface water depletion. If a numerical groundwater and surface water model is not used to quantify surface water depletion, the Plan shall identify and describe an equally effective method, tool, or analytical model to accomplish the requirements of this Paragraph.	359:362, 378:379	5.2.7, 5.3.3	5-91	5-9	Refer to Appendix 5-G: C2VSimFG-Sutter Model Report (submitted as Supporting Information).
(d)		An Agency may establish a representative minimum threshold for groundwater elevation to serve as the value for multiple sustainability indicators, where the Agency can demonstrate that the representative value is a reasonable proxy for multiple individual minimum thresholds as supported by adequate evidence.	433, 446:451	6.5.2, 6.5.6.1			
(e)		An Agency that has demonstrated that undesirable results related to one or more sustainability indicators are not present and are not likely to occur in a basin, as described in Section 354.26, shall not be required to establish minimum thresholds related to those sustainability indicators.	417	6.4.3			
		Note: Authority cited: Section 10733.2, Water Code.					
		Reference: Sections 10723.2, 10727.2, 10733, 10733.2, and 10733.8, Water Code.					
§ 354.30.		Measurable Objectives					
(a)		Each Agency shall establish measurable objectives, including interim milestones in increments of five years, to achieve the sustainability goal for the basin within 20 years of Plan implementation and to continue to sustainably manage the groundwater basin over the planning and implementation horizon.	457:472	6.6		6-5:6-8	
(b)		Measurable objectives shall be established for each sustainability indicator, based on quantitative values using the same metrics and monitoring sites as are used to define the minimum thresholds.	457:472	6.6		6-5:6-8	
(c)		Measurable objectives shall provide a reasonable margin of operational flexibility under adverse conditions which shall take into consideration components such as historical water budgets, seasonal and long-term trends, and periods of drought, and be commensurate with levels of uncertainty.	457:472	6.6		6-5:6-8	
(d)		An Agency may establish a representative measurable objective for groundwater elevation to serve as the value for multiple sustainability indicators where the Agency can demonstrate that the representative value is a reasonable proxy for multiple individual measurable objectives as supported by adequate evidence.	463, 468:472	6.6.2, 6.6.6			

Article 5.

Plan Contents for Sutter Basin

GSP Document References

			Page Numbers of Plan	Or Section Numbers	Or Figure Numbers	Or Table Numbers	Notes
(e)		Each Plan shall describe a reasonable path to achieve the sustainability goal for the basin within 20 years of Plan implementation, including a description of interim milestones for each relevant sustainability indicator, using the same metric as the measurable objective, in increments of five years. The description shall explain how the Plan is likely to maintain sustainable groundwater management over the planning and implementation horizon.	457:472	6.6		6-5:6-8	
(f)		Each Plan may include measurable objectives and interim milestones for additional Plan elements described in Water Code Section 10727.4 where the Agency determines such measures are appropriate for sustainable groundwater management in the basin.	N/A				Measurable objectives and interim milestones for additional Plan elements described in Water Code Section 10727.4 have not been included, as this is optional.
(g)		An Agency may establish measurable objectives that exceed the reasonable margin of operational flexibility for the purpose of improving overall conditions in the basin, but failure to achieve those objectives shall not be grounds for a finding of inadequacy of the Plan.	457:472	6.6		6-5:6-8	Established measurable objectives are not considered to exceed a reasonable margin of operational flexibility.
		Note: Authority cited: Section 10733.2, Water Code.					
		Reference: Sections 10727.2, 10727.4, and 10733.2, Water Code.					
SubArticle 4. Monitoring Networks							
§ 354.32. Introduction to Monitoring Networks							
		This Subarticle describes the monitoring network that shall be developed for each basin, including monitoring objectives, monitoring protocols, and data reporting requirements. The monitoring network shall promote the collection of data of sufficient quality, frequency, and distribution to characterize groundwater and related surface water conditions in the basin and evaluate changing conditions that occur through implementation of the Plan.					
		Note: Authority cited: Section 10733.2, Water Code.					
		Reference: Section 10733.2, Water Code.					
§ 354.34. Monitoring Network							
(a)		Each Agency shall develop a monitoring network capable of collecting sufficient data to demonstrate short-term, seasonal, and long-term trends in groundwater and related surface conditions, and yield representative information about groundwater conditions as necessary to evaluate Plan implementation.	581:637	7.2			
(b)		Each Plan shall include a description of the monitoring network objectives for the basin, including an explanation of how the network will be developed and implemented to monitor groundwater and related surface conditions, and the interconnection of surface water and groundwater, with sufficient temporal frequency and spatial density to evaluate the affects and effectiveness of Plan implementation. The monitoring network objectives shall be implemented to accomplish the following:					
	(1)	Demonstrate progress toward achieving measurable objectives described in the Plan.	585	7.2.2			
	(2)	Monitor impacts to the beneficial uses or users of groundwater.	585	7.2.2			

Article 5.

Plan Contents for Sutter Basin

			GSP Document References				
			Page Numbers of Plan	Or Section Numbers	Or Figure Numbers	Or Table Numbers	Notes
	(3)	Monitor changes in groundwater conditions relative to measurable objectives and minimum thresholds.	585	7.2.2			
	(4)	Quantify annual changes in water budget components.	585	7.2.2			
(c)		Each monitoring network shall be designed to accomplish the following for each sustainability indicator:					
	(1)	Chronic Lowering of Groundwater Levels. Demonstrate groundwater occurrence, flow directions, and hydraulic gradients between principal aquifers and surface water features by the following methods:					
	(A)	A sufficient density of monitoring wells to collect representative measurements through depth-discrete perforated intervals to characterize the groundwater table or potentiometric surface for each principal aquifer.	592:601	7.2.6.1.1:7.2.6.1.2	7-2:7-5	7-47:7-49	
	(B)	Static groundwater elevation measurements shall be collected at least two times per year, to represent seasonal low and seasonal high groundwater conditions.	601:602	7.2.6.1.3			
	(2)	Reduction of Groundwater Storage. Provide an estimate of the change in annual groundwater in storage.	606	7.2.6.2			
	(3)	Seawater Intrusion. Monitor seawater intrusion using chloride concentrations, or other measurements convertible to chloride concentrations, so that the current and projected rate and extent of seawater intrusion for each applicable principal aquifer may be calculated.	606	7.2.6.3			Seawater intrusion is not an applicable sustainability indicator for the Sutter Subbasin as the Subbasin is located inland from the Pacific Ocean and is not adjacent to the Sacramento-San Joaquin Delta.
	(4)	Degraded Water Quality. Collect sufficient spatial and temporal data from each applicable principal aquifer to determine groundwater quality trends for water quality indicators, as determined by the Agency, to address known water quality issues.	606:614	7.2.6.4.1:7.2.6.4.3	7-7:7-11	7-50	
	(5)	Land Subsidence. Identify the rate and extent of land subsidence, which may be measured by extensometers, surveying, remote sensing technology, or other appropriate method.	619:624	7.2.6.5.1:7.2.6.5.3	7-12	7-51	
	(6)	Depletions of Interconnected Surface Water. Monitor surface water and groundwater, where interconnected surface water conditions exist, to characterize the spatial and temporal exchanges between surface water and groundwater, and to calibrate and apply the tools and methods necessary to calculate depletions of surface water caused by groundwater extractions. The monitoring network shall be able to characterize the following:					
	(A)	Flow conditions including surface water discharge, surface water head, and baseflow contribution.	626:635	7.2.6.6.1:7.2.6.6.3	7-13:7-16	7-52:7-53	
	(B)	Identifying the approximate date and location where ephemeral or intermittent flowing streams and rivers cease to flow, if applicable.	626:635	7.2.6.6.1:7.2.6.6.3	7-13:7-16	7-52:7-53	
	(C)	Temporal change in conditions due to variations in stream discharge and regional groundwater extraction.	626:635	7.2.6.6.1:7.2.6.6.3	7-13:7-16	7-52:7-53	
	(D)	Other factors that may be necessary to identify adverse impacts on beneficial uses of the surface water.	626:635	7.2.6.6.1:7.2.6.6.3	7-13:7-16	7-52:7-53	

Article 5.

Plan Contents for Sutter Basin

GSP Document References

			Page Numbers of Plan	Or Section Numbers	Or Figure Numbers	Or Table Numbers	Notes
(d)		The monitoring network shall be designed to ensure adequate coverage of sustainability indicators. If management areas are established, the quantity and density of monitoring sites in those areas shall be sufficient to evaluate conditions of the basin setting and sustainable management criteria specific to that area.	592:600, 606:613, 619:623, 627:634	7.2.6.1.1, 7.2.6.2, 7.2.6.4.1, 7.2.6.5.1, 7.2.6.6.1	7-2:7-16	7-47:7-48, 7-50:7-53	No management areas are defined within the Sutter Subbasin.
(e)		A Plan may utilize site information and monitoring data from existing sources as part of the monitoring network.	592:600, 606:613, 619:623, 627:634	7.2.6.1.1, 7.2.6.2, 7.2.6.4.1, 7.2.6.5.1, 7.2.6.6.1	7-2:7-16	7-48, 7-50:7-53	
(f)		The Agency shall determine the density of monitoring sites and frequency of measurements required to demonstrate short-term, seasonal, and long-term trends based upon the following factors:					
	(1)	Amount of current and projected groundwater use.	601:602, 606, 614, 624, 635	7.2.6.1.2:7.2.6.1.3, 7.2.6.2, 7.2.6.4.2:7.2.6.4.3, 7.2.6.5.2:7.2.6.5.3, 7.2.6.6.2:7.2.6.6.3		7-49	
	(2)	Aquifer characteristics, including confined or unconfined aquifer conditions, or other physical characteristics that affect groundwater flow.	601:602, 606, 614, 624, 635	7.2.6.1.2:7.2.6.1.3, 7.2.6.2, 7.2.6.4.2:7.2.6.4.3, 7.2.6.5.2:7.2.6.5.3, 7.2.6.6.2:7.2.6.6.3		7-49	
	(3)	Impacts to beneficial uses and users of groundwater and land uses and property interests affected by groundwater production, and adjacent basins that could affect the ability of that basin to meet the sustainability goal.	601:602, 606, 614, 624, 635	7.2.6.1.2:7.2.6.1.3, 7.2.6.2, 7.2.6.4.2:7.2.6.4.3, 7.2.6.5.2:7.2.6.5.3, 7.2.6.6.2:7.2.6.6.3		7-49	

Article 5.

Plan Contents for Sutter Basin

GSP Document References

			Page Numbers of Plan	Or Section Numbers	Or Figure Numbers	Or Table Numbers	Notes
(4)		Whether the Agency has adequate long-term existing monitoring results or other technical information to demonstrate an understanding of aquifer response.	601:602, 606, 614, 624, 635	7.2.6.1.2:7.2.6.1.3, 7.2.6.2, 7.2.6.4.2:7.2.6.4.3, 7.2.6.5.2:7.2.6.5.3, 7.2.6.6.2:7.2.6.6.3		7-49	
(g)		Each Plan shall describe the following information about the monitoring network:					
(1)		Scientific rationale for the monitoring site selection process.	586, 592:600, 606:613, 619:623, 627:634	7.2.4, 7.2.6.1.1, 7.2.6.2, 7.2.6.4.1, 7.2.6.5.1, 7.2.6.6.1			
(2)		Consistency with data and reporting standards described in Section 352.4. If a site is not consistent with those standards, the Plan shall explain the necessity of the site to the monitoring network, and how any variation from the standards will not affect the usefulness of the results obtained.	587:589	7.2.5.1			
(3)		For each sustainability indicator, the quantitative values for the minimum threshold, measurable objective, and interim milestones that will be measured at each monitoring site or representative monitoring sites established pursuant to Section 354.36.	602:604, 606, 614:618, 624:626, 635:637	7.2.6.1.4, 7.2.6.2, 7.2.6.4.4, 7.2.6.5.4, 7.2.6.6.4			
(h)		The location and type of each monitoring site within the basin displayed on a map, and reported in tabular format, including information regarding the monitoring site type, frequency of measurement, and the purposes for which the monitoring site is being used.	595:600, 607:613, 621:623, 629:634		7-2:7-5, 7-7:7-16	7-48, 7-50:7-53	
(i)		The monitoring protocols developed by each Agency shall include a description of technical standards, data collection methods, and other procedures or protocols pursuant to Water Code Section 10727.2(f) for monitoring sites or other data collection facilities to ensure that the monitoring network utilizes comparable data and methodologies.	602:604, 606, 614:618, 624:626, 635:637	7.2.6.1.4, 7.2.6.2, 7.2.6.4.4, 7.2.6.5.4, 7.2.6.6.4			
(j)		An Agency that has demonstrated that undesirable results related to one or more sustainability indicators are not present and are not likely to occur in a basin, as described in Section 354.26, shall not be required to establish a monitoring network related to those sustainability indicators.	606	7.2.6.3			Seawater intrusion is not an applicable sustainability indicator for the Sutter Subbasin as the Subbasin is located inland from the Pacific Ocean and is not adjacent to the Sacramento-San Joaquin Delta.
		Note: Authority cited: Section 10733.2, Water Code.					
		Reference: Sections 10723.2, 10727.2, 10727.4, 10728, 10733, 10733.2, and 10733.8, Water Code					
§ 354.36.		Representative Monitoring					

Article 5.

Plan Contents for Sutter Basin

			GSP Document References				
			Page Numbers of Plan	Or Section Numbers	Or Figure Numbers	Or Table Numbers	Notes
		Each Agency may designate a subset of monitoring sites as representative of conditions in the basin or an area of the basin, as follows:					
(a)		Representative monitoring sites may be designated by the Agency as the point at which sustainability indicators are monitored, and for which quantitative values for minimum thresholds, measurable objectives, and interim milestones are defined.	586	7.2.3			
(b)		(b) Groundwater elevations may be used as a proxy for monitoring other sustainability indicators if the Agency demonstrates the following:					
	(1)	Significant correlation exists between groundwater elevations and the sustainability indicators for which groundwater elevation measurements serve as a proxy.	606, 635	7.2.6.2, 7.2.6.6.4			
	(2)	Measurable objectives established for groundwater elevation shall include a reasonable margin of operational flexibility taking into consideration the basin setting to avoid undesirable results for the sustainability indicators for which groundwater elevation measurements serve as a proxy.	463, 468:472	6.6.2, 6.6.6			
(c)		The designation of a representative monitoring site shall be supported by adequate evidence demonstrating that the site reflects general conditions in the area.	586	7.2.3			
		Note: Authority cited: Section 10733.2, Water Code.					
		Reference: Sections 10727.2 and 10733.2, Water Code					
§ 354.38.		Assessment and Improvement of Monitoring Network					
(a)		Each Agency shall review the monitoring network and include an evaluation in the Plan and each five-year assessment, including a determination of uncertainty and whether there are data gaps that could affect the ability of the Plan to achieve the sustainability goal for the basin.	664:665	8.10.3:8.10.4			
(b)		Each Agency shall identify data gaps wherever the basin does not contain a sufficient number of monitoring sites, does not monitor sites at a sufficient frequency, or utilizes monitoring sites that are unreliable, including those that do not satisfy minimum standards of the monitoring network adopted by the Agency.	604, 618:619, 626, 637	7.2.6.1.5, 7.2.6.4.5, 7.2.6.5.5, 7.2.6.6.5			
(c)		If the monitoring network contains data gaps, the Plan shall include a description of the following:					
	(1)	The location and reason for data gaps in the monitoring network.	604, 618:619, 626, 637	7.2.6.1.5, 7.2.6.4.5, 7.2.6.5.5, 7.2.6.6.5			
	(2)	Local issues and circumstances that limit or prevent monitoring.	604, 618:619, 626, 637	7.2.6.1.5, 7.2.6.4.5, 7.2.6.5.5, 7.2.6.6.5			

Article 5.

Plan Contents for Sutter Basin

GSP Document References

			Page Numbers of Plan	Or Section Numbers	Or Figure Numbers	Or Table Numbers	Notes
(d)		Each Agency shall describe steps that will be taken to fill data gaps before the next five-year assessment, including the location and purpose of newly added or installed monitoring sites.	604, 619, 626, 637	7.2.6.1.6, 7.2.6.4.6, 7.2.6.5.6, 7.2.6.6.6			
(e)		Each Agency shall adjust the monitoring frequency and density of monitoring sites to provide an adequate level of detail about site-specific surface water and groundwater conditions and to assess the effectiveness of management actions under circumstances that include the following:					
	(1)	Minimum threshold exceedances.	591:592	7.2.6			
	(2)	Highly variable spatial or temporal conditions.	591:592	7.2.6			
	(3)	Adverse impacts to beneficial uses and users of groundwater.	591:592	7.2.6			
	(4)	The potential to adversely affect the ability of an adjacent basin to implement its Plan or impede achievement of sustainability goals in an adjacent basin.	591:592	7.2.6			
		Note: Authority cited: Section 10733.2, Water Code.					
		Reference: Sections 10723.2, 10727.2, 10728.2, 10733, 10733.2, and 10733.8, Water Code					
§ 354.40.		Reporting Monitoring Data to the Department					
		Monitoring data shall be stored in the data management system developed pursuant to Section 352.6. A copy of the monitoring data shall be included in the Annual Report and submitted electronically on forms provided by the Department.					
		Note: Authority cited: Section 10733.2, Water Code.					
		Reference: Sections 10728, 10728.2, 10733.2, and 10733.8, Water Code.					
SubArticle 5.		Projects and Management Actions					
§ 354.42.		Introduction to Projects and Management Actions					
		This Subarticle describes the criteria for projects and management actions to be included in a Plan to meet the sustainability goal for the basin in a manner that can be maintained over the planning and implementation horizon.					
		Note: Authority cited: Section 10733.2, Water Code.					
		Reference: Section 10733.2, Water Code.					
§ 354.44.		Projects and Management Actions					
(a)		Each Plan shall include a description of the projects and management actions the Agency has determined will achieve the sustainability goal for the basin, including projects and management actions to respond to changing conditions in the basin.	477:579	7.1			
(b)		Each Plan shall include a description of the projects and management actions that include the following:					

Article 5. Plan Contents for Sutter Basin

			GSP Document References				Notes
			Page Numbers of Plan	Or Section Numbers	Or Figure Numbers	Or Table Numbers	
(1)		A list of projects and management actions proposed in the Plan with a description of the measurable objective that is expected to benefit from the project or management action. The list shall include projects and management actions that may be utilized to meet interim milestones, the exceedance of minimum thresholds, or where undesirable results have occurred or are imminent. The Plan shall include the following:					
(A)		A description of the circumstances under which projects or management actions shall be implemented, the criteria that would trigger implementation and termination of projects or management actions, and the process by which the Agency shall determine that conditions requiring the implementation of particular projects or management actions have occurred.	499:500, 507, 516, 523:524, 530, 533, 536:544, 546:570, 572:575	7.1.4.1.2.5, 7.1.4.2.2.5, 7.1.4.3.2.5, 7.1.4.4.2.5, 7.1.4.5.2.5, 7.1.4.6.2.5, 7.1.5:7.1.6		7-20:7-43	
(B)		The process by which the Agency shall provide notice to the public and other agencies that the implementation of projects or management actions is being considered or has been implemented, including a description of the actions to be taken.	498, 506, 515, 523, 530, 533, 536:544, 546:570, 572:575, 659	7.1.4.1.2.2, 7.1.4.2.2.2, 7.1.4.3.2.2, 7.1.4.4.2.2, 7.1.4.5.2.2, 7.1.4.6.2.2, 7.1.5:7.1.6, 8.4		7-20:7-43	
(2)		If overdraft conditions are identified through the analysis required by Section 354.18, the Plan shall describe projects or management actions, including a quantification of demand reduction or other methods, for the mitigation of overdraft.	N/A				Overdraft conditions have not historically occurred and are not projected to occur in the Sutter Subbasin, based on best available data at the time of writing the GSP.

Article 5. Plan Contents for Sutter Basin

				GSP Document References				Notes
				Page Numbers of Plan	Or Section Numbers	Or Figure Numbers	Or Table Numbers	
(3)		A summary of the permitting and regulatory process required for each project and management action.	500, 507:508, 516:517, 524, 531, 533:534, 536:544, 546:570, 572:575	7.1.4.1.2.6, 7.1.4.2.2.6, 7.1.4.3.2.6, 7.1.4.4.2.6, 7.1.4.5.2.6, 7.1.4.6.2.6, 7.1.5:7.1.6		7-20:7-43		
(4)		The status of each project and management action, including a time-table for expected initiation and completion, and the accrual of expected benefits.	498, 505, 514:515, 522, 529:530, 532:533, 536:544, 546:570, 572:575	7.1.4.1.2.1, 7.1.4.2.2.1, 7.1.4.3.2.1, 7.1.4.4.2.1, 7.1.4.5.2.1, 7.1.4.6.2.1, 7.1.5:7.1.6		7-20:7-43		
(5)		An explanation of the benefits that are expected to be realized from the project or management action, and how those benefits will be evaluated.	501:502, 509, 518:520, 524:525, 531, 534:544, 546:570, 572:575	7.1.4.1.4.1, 7.1.4.2.4.1, 7.1.4.3.4, 7.1.4.4.4, 7.1.4.5.4, 7.1.4.6.4, 7.1.5:7.1.6		7-20:7-43		

Article 5.

Plan Contents for Sutter Basin

				GSP Document References				
				Page Numbers of Plan	Or Section Numbers	Or Figure Numbers	Or Table Numbers	Notes
(6)		An explanation of how the project or management action will be accomplished. If the projects or management actions rely on water from outside the jurisdiction of the Agency, an explanation of the source and reliability of that water shall be included.		499, 506:507, 515:516, 523, 530, 533, 536:544, 546:570, 572:575	7.1.4.1.2.3: 7.1.4.1.2.4, 7.1.4.2.2.3: 7.1.4.2.2.4, 7.1.4.3.2.3: 7.1.4.3.2.4, 7.1.4.4.2.3: 7.1.4.4.2.4, 7.1.4.5.2.3: 7.1.4.5.2.4, 7.1.4.6.2.3: 7.1.4.6.2.4, 7.1.5:7.1.6		7-20:7-43	
(7)		A description of the legal authority required for each project and management action, and the basis for that authority within the Agency.		500, 507:508, 516:517, 524, 531, 533:534, 536:544, 546:570, 572:575	7.1.4.1.2.6, 7.1.4.2.2.6, 7.1.4.3.2.6, 7.1.4.4.2.6, 7.1.4.5.2.6, 7.1.4.6.2.6, 7.1.5:7.1.6		7-20:7-43	
(8)		A description of the estimated cost for each project and management action and a description of how the Agency plans to meet those costs.		502, 510, 518:520, 524:525, 531, 534:544, 546:570, 572:575	7.1.4.1.4.2, 7.1.4.2.4.2, 7.1.4.3.4, 7.1.4.4.4, 7.1.4.5.4, 7.1.4.6.4, 7.1.5:7.1.6		7-8, 7-12, 7-14, 7-16, 7-19:7-43	
(9)		A description of the management of groundwater extractions and recharge to ensure that chronic lowering of groundwater levels or depletion of supply during periods of drought is offset by increases in groundwater levels or storage during other periods.		576:578	7.1.9			

Article 5. Plan Contents for Sutter Basin

			GSP Document References				
			Page Numbers of Plan	Or Section Numbers	Or Figure Numbers	Or Table Numbers	Notes
(c)		Projects and management actions shall be supported by best available information and best available science.	477:579	7.1			
(d)		An Agency shall take into account the level of uncertainty associated with the basin setting when developing projects or management actions.	477:579	7.1			
		Note: Authority cited: Section 10733.2, Water Code.					
		Reference: Sections 10727.2, 10727.4, and 10733.2, Water Code.					

This page intentionally left blank.

Appendix 3-A
Memorandum of Understanding for Sustainable
Groundwater Management

This page intentionally left blank.

**MEMORANDUM OF UNDERSTANDING
BETWEEN SUTTER SUBBASIN GROUNDWATER SUSTAINABILITY AGENCIES
FOR SUSTAINABLE GROUNDWATER MANAGEMENT**

This MEMORANDUM OF UNDERSTANDING BETWEEN THE SUTTER SUBBASIN GROUNDWATER SUSTAINABILITY AGENCIES FOR SUSTAINABLE GROUNDWATER MANAGEMENT is made effective as of April 27, 2021 (the "Effective Date") by and between the Sutter County Groundwater Sustainability Agency (GSA), the Butte Water District GSA, the City of Live Oak GSA, the Sutter Extension Water District GSA, the Sutter Community Services District GSA, the City of Yuba City GSA, the Reclamation District 70 GSA, the Reclamation District 1660 GSA, and the Reclamation District 1500 GSA.

RECITALS

WHEREAS, on September 16, 2014 Governor Brown signed into law Senate Bills 1 168 and 1319 and Assembly Bill 1739, known collectively as the Sustainable Groundwater Management Act (SGMA); and

WHEREAS, SGMA went into effect on January 1, 2015; and

WHEREAS, SGMA seeks to provide sustainable management of groundwater basins, enhance local management of groundwater, establish minimum standards for sustainable groundwater management, and provide local groundwater agencies with the authority and the technical and financial assistance necessary to sustainably manage groundwater; and

WHEREAS, each of the Parties overlies the Sutter Subbasin (Basin Number 5-21.62, Department of Water Resources [DWR] Bulletin 118) within the Sacramento Valley Groundwater Basin, which has been designated as a medium-priority basin by DWR; and

WHEREAS, the Sutter County GSA elected to manage the groundwater over the boundaries of its members and act as the GSA pursuant to SGMA and notified DWR on or about April 11, 2017; and

WHEREAS, the Butte Water District GSA elected to manage the groundwater over the boundaries of its members and act as the GSA pursuant to SGMA and notified DWR on or about October 1, 2015; and

WHEREAS, the City of Live Oak GSA elected to manage the groundwater over the boundaries of the water district and act as the GSA pursuant to SGMA and notified DWR on or about November 24, 2015; and

WHEREAS, the Sutter Extension Water District GSA elected to manage the groundwater over the boundaries of the water district and act as the GSA pursuant to SGMA and notified DWR on or about October 27, 2015; and

WHEREAS, the Sutter Community Services District GSA elected to manage the groundwater over the boundaries of the water district and act as the GSA pursuant to SGMA and notified DWR on or about October 1, 2015; and

WHEREAS, the City of Yuba City GSA elected to manage the groundwater over the boundaries of the water district and act as the GSA pursuant to SGMA and notified DWR on or about April 27, 2017; and

WHEREAS, the Reclamation District 70 GSA elected to manage the groundwater over the boundaries of the water district and act as the GSA pursuant to SGMA and notified DWR on or about June 6, 2017; and

WHEREAS, the Reclamation District 1660 GSA elected to manage the groundwater over the boundaries of the water district and act as the GSA pursuant to SGMA and notified DWR on or about June 6, 2017; and

WHEREAS, the Reclamation District 1500 GSA elected to manage the groundwater over the boundaries of the water district and act as the GSA pursuant to SGMA and notified DWR on or about April 7, 2017; and

WHEREAS, collectively, the boundaries of the Parties include all lands overlying the Basin;

WHEREAS, the Parties desire, through this Agreement, to coordinate the work of the GSAs and the management of the Basin, in accordance with SGMA; and

WHEREAS, the Parties shall designate a point of contact for the Sutter Subbasin Groundwater Sustainability Plan development, who shall communicate with all other Parties.

NOW, THEREFORE, in consideration of the mutual promises, covenants and conditions herein set forth, the Parties agree as follows:

ARTICLE 1: DEFINITIONS

As used in this Agreement, unless the context requires otherwise, the meaning of the terms hereinafter set forth shall be as follows:

- 1.1 **"Agreement"** shall mean this Memorandum of Understanding among the Sutter County Groundwater Sustainability Agency, the Butte Water District Groundwater Sustainability Agency, the City of Live Oak Groundwater Sustainability Agency, the Sutter Extension Water District Groundwater Sustainability Agency, the Sutter Community Services District Groundwater Sustainability Agency, the City of Yuba City Groundwater Sustainability Agency, the Reclamation District 70 Groundwater Sustainability Agency, the Reclamation District 1660 Groundwater Sustainability Agency, and the Reclamation District 1500 Groundwater Sustainability Agency.
- 1.2 **"Basin"** shall mean Sutter Groundwater Subbasin, California Department of Water Resources Basin No. 5-21.62 as its boundaries may be modified from time to time in accordance with Cal. Water Code Section 10722.2.
- 1.3 **"Coordination Agreement"** shall mean a legal agreement adopted between two or more GSAs that provides the basis for intra-basin coordination of multiple GSPs within that basin pursuant to SGMA.
- 1.4 **"Coordination Committee"** is defined in Article 4 of this Agreement.
- 1.5 **"DWR"** shall mean the California Department of Water Resources.
- 1.6 **"Effective Date"** shall mean the date on which the last Party executes this Agreement.
- 1.7 **"Groundwater Sustainability Agency" or "GSA"** shall mean an agency enabled by SGMA to regulate a portion of the Basin cooperatively with all other Groundwater Sustainability Agencies in the Basin, in compliance with the terms and provisions of SGMA.
- 1.8 **"GSAs"** shall mean the nine (9) GSAs in the Sutter Subbasin, namely the Sutter County GSA, the Butte Water District GSA, the City of Live Oak GSA, the Sutter Extension Water District GSA, the Sutter Community Services District GSA, the City of Yuba City GSA, the Reclamation District 70 GSA, the Reclamation District 1660 GSA, and the Reclamation District 1500 GSA.
- 1.9 **"Groundwater Sustainability Plan" or "GSP"** shall have the definition set forth in SGMA.

- 1.10 "RD" shall mean the Reclamation District.
- 1.11 "Notice" is defined in Section 4.2 of this Agreement.
- 1.12 "Party" shall mean any of the signatories to this Agreement and "Parties" shall mean all of the signatories to this Agreement.
- 1.13 "Plan Manager" shall mean an employee or authorized representative of a GSA, or GSAs, appointed through a coordination agreement or other agreement, who has been delegated management authority for submitting the Plan and serving as the point of contact between the GSA or GSAs and DWR.
- 1.14 "SGMA" or "Act" shall mean the Sustainable Groundwater Management Act of 2014 and all regulations adopted under the legislation (SB 1168, SB 1319 and AB 1739) that collectively comprise the Act, as that legislation and those regulations may be amended from time to time.

ARTICLE 2: KEY PRINCIPLES

- 2.1 The Parties intend to work together in mutual cooperation to develop one GSP in compliance with SGMA for the sustainable management of groundwater in the Basin.
- 2.2 The Parties intend to designate a Plan Manager for the GSP and delegate management authority to that person for submitting the Plan and any subsequent documents required under SGMA, and for serving as the point of contact between the Parties and DWR.
- 2.3 The Parties intend to mutually cooperate to the extent possible to jointly implement the GSP within the Basin.
- 2.4 To the extent the Parties are not successful at jointly implementing the GSP within the Basin, or to the extent that any Party wishes to independently implement the GSP within their boundaries, a Party may implement the GSP within its boundaries, and agree to work together with all Parties to coordinate such implementation in accordance with the requirements of SGMA.
- 2.5 The Parties expressly intend that this Agreement shall not limit or interfere with the right and authority of any Party over its own internal matters, including, but not limited to, a Party's legal rights to surface water supplies and assets, groundwater supplies and assets, facilities, operations, water management and water supply matters. The Parties make no commitments by entering into this Agreement to share or otherwise contribute their water supply assets as part of the development or implementation of a GSP.
- 2.6 Nothing in this Agreement is intended to modify or limit the Parties' police powers, land use authorities, or any other authority.
- 2.7 The Parties further intend through this Agreement to cooperate to obtain consulting, administrative, and management services needed to efficiently develop a GSP, to conduct outreach to other basin agencies and private parties, and to identify mechanisms for the management reasonably anticipated to be necessary for the purposes of this Agreement.
- 2.8 Each of the Parties acknowledges that SGMA requires that the entire Basin must be managed under one or more GSPs for the basin to be deemed in compliance with SGMA, and that if multiple GSPs are adopted within the Basin the GSAs must coordinate, and are required to use the same data and consistent methodologies for certain required technical assumptions when developing a GSP.

ARTICLE 3: PURPOSE AND POWERS

3.1 **Purpose of the Agreement.** The purposes of this Agreement is to:

- a. Cooperatively carry out the purposes of SGMA;
- b. Provide for coordination among the Parties to develop and implement a GSP and/or facilitate a Coordination Agreement, to the extent necessary;
- c. Develop, adopt and implement a legally sufficient GSP covering those portions of the Basin that are within the jurisdictional boundaries of the Parties, subject to the limitations set forth in this Agreement;
- d. Satisfy the requirements of SGMA for coordination among GSAs.

3.2 **Authority Under the Agreement.** To the extent authorized by the Parties and subject to the limitations set forth in this Agreement and the limitations of all applicable laws, the Parties acting collectively shall have the following authority including, but not limited to, the power:

- a. To coordinate the implementation of SGMA among the Parties in accordance with this Agreement;
- b. To recommend the adoption of actions, rules, regulations, policies, and procedures related to the coordination of the Parties for purposes of implementation of SGMA;
- c. To perform all acts necessary or proper to carry out fully the purposes of this Agreement, and to exercise all other powers necessary and incidental to the implementation of the powers set forth herein.

3.3 **Powers Reserved to Parties.** Each Party will retain the sole and absolute right, in its sole discretion, to:

- a. Be a GSA individually or collectively within the Party 's boundaries;
- b. Approve any portion, section or chapter of the GSP adopted by the Parties as applicable within the Party's boundaries;
- c. Exercise the authorities granted to each Party as a GSA under SGMA;
- d. Implement SGMA and any GSP adopted pursuant to this Agreement within its boundaries;

Notwithstanding anything to the contrary in this Agreement, this Agreement does not provide any Party the authority to undertake any activities within the geographic or service area boundaries of any of other Party pursuant to the GSP developed or adopted hereunder, unless the Parties have formally and expressly consented and agreed in writing to the activity proposed.

3.4 **Term.** This Agreement shall be effective as of the Effective Date and shall remain in effect until terminated in accordance with Article 7.3 of this Agreement.

3.5 **Role of Party Agencies.** Each of the Parties agrees to undertake such additional proceedings or actions as may be necessary in order to carry out the terms and intent of this Agreement. The support of all Parties is required for the success of this Agreement. This support will involve the following types of actions:

- a. The Parties will provide support to a Coordination Committee and any third party facilitating the development of the GSP by making available staff time, information and facilities within available resources;

- b. Policy support shall be provided by the Parties to either approve, or respond quickly to, any recommendations made as to funding shares, operational decisions, and other policy areas;
- c. Contributions of public funds and of personnel, services, equipment or property may be made by any Parties for any of the purposes of this Agreement provided that no repayment will be made for such contributions.

3.6 **Other Officers and Employees.** To the extent the Parties, or any third party facilitating the development of the GSP, need support from employees, officers, consultants or otherwise need to hire employees, the Parties may do the following:

- a. Provide that any employee of any Party with the express approval of that Party, may work on behalf of the Parties under this Agreement, and shall perform, the same various duties under the direction of the Coordination Committee as for his or her other employer in order to carry out this Agreement. This work may be completed and funded under the existing employment with one of the Parties. In the alternative, the Coordination Committee may recommend that the Parties to this Agreement enter into agreements to compensate, off-set costs, or otherwise fund the cost of the employment for work performed under this Agreement;
- b. The Parties shall collectively contract or hire consultants and/or employees to perform work under this Agreement. The Parties may designate one Party to administer the contract. For each contract that will require cost sharing amongst the parties, the proposed contract will be presented to the Coordination Committee for review, and each Party must approve the contract pursuant to that Party's approval requirements. Such contracts shall be drafted in a manner to reflect that consultants hired to perform work under this Agreement are working on behalf of all the Parties and will be expected to work with the Parties on a collective basis and with each Party on an individual basis. Such contracts shall be made to be enforceable by all applicable Parties. Additionally, the contracts must include appropriate indemnity, insurance, and non-disclosures to protect all Parties. Once approved, no expansion, addition, or change to an approved scope of work in a signed contract involving and increase or decrease in compensation under the contract can be made by the contract administrator until approved by each Party pursuant to that Party's approval requirements.

ARTICLE 4: GOVERNANCE

4.1 **Coordination Committee.** The activities under this Agreement will be guided by a Coordination Committee made up of up to one (1) representative from each of the Parties. The Coordination Committee shall work collaboratively under the terms of this Agreement to develop recommendations for the technical and substantive Basin-wide issues. These recommendations shall be reached by a simple majority vote of the Coordination Committee and submitted to each Party's governing board for final approval. The governing body of each Party must approve the recommendations of the Coordination Committee prior to them becoming effective.

The Coordination Committee shall develop, but not be limited to, the following recommendations:

- a. Recommend budget(s) and appropriate cost sharing for any project or program that requires funding from the Parties;
- b. Recommend guidance and options for obtaining grant funding;
- c. Recommend the adoption of rules, regulations, policies, and procedures related to the Agreement;

- d. Recommend the approval of any contracts with consultants or subcontractors that would undertake work on behalf of the Parties and/or relate to Basin-wide issues and, if applicable, recommend the funding that each Party should contribute towards the costs of such contracts;
- e. Report to the Parties respective governing boards when dispute resolution is needed to resolve an impasse or inability to make a consensus recommendation;
- f. Recommend action and/or approval of a GSP.

4.2 **Dispute Resolution.** Should any controversy arise among or between the Parties concerning this Agreement, or the rights and duties of any Party under this Agreement, such a controversy shall be addressed as follows:

- a. Any Party may trigger the dispute resolution process by submitting, in writing to all Parties, a request for a meeting to confer to avoid litigation ("Notice"). Within thirty (30) days after receipt of Notice, the Parties shall attempt in good faith to resolve the controversy through informal means. If the Parties cannot agree upon a resolution of the controversy within sixty (60) days from receipt of Notice, the dispute shall be submitted to mediation prior to the commencement of legal action.
- b. Mediation shall be no less than a full day (unless otherwise agreed upon by the Parties) and the cost of mediation shall be paid in equal proportion among the Parties.
- c. The mediator shall be either voluntarily agreed to, or, if the Parties cannot agree upon a mediator, selected by the method set forth in (i) or (ii) below:
 - i. Each Party shall appoint one mediator in writing. At the next meeting of the Coordination Committee, a mediator will be selected through consensus.
 - ii. If consensus cannot be reached to select a mediator, at the meeting of the Coordination Committee, one member shall randomly select the name of one mediator from a container containing the nine names submitted.
 - iii. If the nine Parties do not voluntarily agree in writing to the randomly selected mediator, then the mediator shall be appointed by the Superior Court upon motion for appointment of a neutral mediator.
- d. Should the mediation process described above not provide a final resolution to the controversy raised, any Party may pursue any judicial or administrative remedies otherwise available. However, notwithstanding this Section 4.2, a Party may seek a preliminary injunction or other interlocutory judicial relief prior to completion of the mediation if necessary to avoid irreparable damage or to preserve the status quo.
- e. The dispute resolution requirement may be pursued concurrent with litigation, if litigation must be filed first to avoid time-bar of a statute of limitations or similar time limit, or if immediate injunctive relief is needed.

ARTICLE 5: EXCHANGE OF DATA AND INFORMATION

5.1 **Exchange of Information.** The Parties acknowledge and recognize pursuant to this Agreement and SGMA, the Parties will need to exchange information amongst and between the Parties and the Parties' consultants.

5.2 **Procedure for Exchange of Information.** The Parties may exchange information through collaboration and/or informal requests made at the Coordination Committee level or through working/stakeholder subcommittees designated by the Coordination Committee. To the extent it is necessary to make a written request for

information to other Parties, the following protocols shall be followed: Each of the Parties shall designate a representative to respond to information requests and provide the name and contact information of the designee to the Coordination Committee. Requests may be communicated in writing and transmitted in person or by mail, facsimile machine or other electronic means to the appropriate representative as named in this agreement.

5.3 Non-Disclosure of Confidential Information.

- a. The Parties acknowledge that, in connection with their mutual activities under this Agreement, each of them may share sensitive and/or confidential information with the other Parties. To the fullest extent permitted by law, including but not limited to the Public Records Act, California Government Code Section 6250 *et seq.*, each of the Parties shall maintain any information, documents or materials shared by the other Parties or mutually developed pursuant to this Agreement, in confidence, and shall not voluntarily provide or reveal such information, documents or materials to any third party. If any Party receives a request or order from a third party that the receiving Party believes requires it to disclose any such information, documents or materials, the receiving party shall (i) immediately notify the other Parties in writing and provide them with a copy of such request or order, (ii) defer any disclosure of such information, documents or material for as long as legally permitted and (iii) cooperate with any other Party that wishes to pursue an order preventing the disclosure of such information, documents or materials.
- b. The Parties further acknowledge and agree that, unless otherwise required by law, any documents, data or material designated as "DRAFT" that is shared with other Parties to this Agreement (1) shall remain confidential; (2) will not be made final or shared with third parties (other than employees or consultants of that Party with a need to know); and (3) shall be used only for the purposes set forth in this Agreement.
- c. If there is a breach or threatened breach of any provision of this Section 5.3, it is agreed and understood that the non-breaching Party shall have no adequate remedy in money or other damages and accordingly shall be entitled to injunctive relief; provided however, no specification in this Agreement of any particular remedy shall be construed as a waiver or prohibition of any other remedies in the event of a breach or threatened breach of this Agreement.

5.4 **Model(s).** The Parties will collectively adopt a single water resources model for purposes of preparing the GSP. Any Party may utilize the model for investigative runs, however, only runs made with assumptions and changes approved by the Parties will be accepted as official for inclusion within the GSP. The approved model will be located at Sutter County until a future location is agreed upon by the Parties. All Parties shall receive copies of the model and shall have access to the model at Sutter County during normal business hours.

ARTICLE 6: FINANCIAL PROVISIONS

- 6.1 **Contributions and Expenses.** Each of the Parties shall be responsible to fund its participation in this Agreement. Funding outside costs, such as consultants, projects, or other Basin-wide activities shall be determined separately for each project. For any such Basin-wide project, the Coordination Committee shall develop a scope of work and recommend a cost allocation for each of the Parties that would need to be approved by a Party's governing board before it is binding on that Party.
- 6.2 **Funding Responsibilities.** Each Party will be solely responsible for raising funds for payment of that Party's share of operating and administrative costs. The obligation of each of the Parties to make payments under the terms and provision of this Agreement is an individual and several obligation and not a joint obligation with those of the other Parties. Each of the Parties shall be individually responsible for its own covenants, obligations, and liabilities under this Agreement. No Party shall be precluded from independently pursuing any of the activities

contemplated in this Agreement. No Party shall be the agent or have the right or power to bind any other Parties without such Party's express written consent, except as expressly provided in this Agreement.

- 6.3 **Alternate Funding Sources.** The Parties may secure contributions of grant funding, state, federal, or other funding as funding or a portion of funding for projects between the Parties.

ARTICLE 7: CHANGES IN PURPOSE, PARTICIPATION, WITHDRAWAL AND TERMINATION

- 7.1 **Changes in Purpose.** This Agreement shall remain in place and all applicable provisions shall remain in effect in the event the Parties determine it is not possible to develop a single GSP pursuant to this Agreement. In that instance, the Parties may develop separate, multiple GSPs, but agree that they will work together to amend this Agreement and utilize this Agreement and the Coordination Committee to meet the requirements of SGMA to utilize the same data and consistent methodologies as required by SGMA, coordinate implementation of the GSPs, and work together as necessary to comply with SGMA. Under those circumstances, this Agreement, as amended, shall constitute the Coordination Agreement required by SGMA.
- 7.2 **Noncompliance.** In the event any Party (1) fails to comply with the terms of this Agreement, or (2) undertakes actions that conflict with or undermine the compliance with SGMA and/or achieving sustainable groundwater management, as determined through mediation or by the Coordination Committee, the Party or Parties alleging non-compliance shall provide written notice summarizing the nature of non-compliance. Further, the non-compliant Party agrees to make best efforts to resolve or remedy any such non-compliance. Such actions may include, for example, failure to pay its agreed upon contributions when due; refusal to participate in GSA activities or to provide required monitoring of sustainability indicators; refusal to enforce controls as required by the GSP; refusal to implement any necessary actions as outlined by the approved GSP minimum thresholds that are likely to lead to "undesirable results" under SGMA.
- 7.3 **Withdrawal and Termination.**
- a. A Party may, in its sole discretion, unilaterally withdraw from this Agreement, effective upon ninety (90) days prior written notice to the governing boards of the other Parties, provided that (1) the withdrawing Party will remain responsible for its proportionate share of any obligation or liability duly incurred while a Party to the Agreement and (2) the withdrawing Party agrees to take all actions after termination to remain in full compliance with SGMA. The withdrawing Parties will not be responsible for its proportional share of any future obligation or liability after the written notice of termination has been given to the governing boards of the other Parties. Thereafter, the withdrawing Party shall not be responsible for any obligations or liabilities incurred by the remaining Parties. In the event the withdrawing Parties have any rights in any property or have incurred obligations, the Parties may not sell, lease or transfer such rights or be relieved of its obligations, except in accordance with a written agreement executed by it and the Parties. This Agreement shall remain in effect for the non-withdrawing parties after the withdrawal of a party.
 - b. This Agreement may be terminated by unanimous written consent of all the Parties. Nothing in this Agreement shall prevent the Parties from entering into another coordination agreement. However, in the event of termination each of the Parties will remain responsible for its proportionate share of all debts, liabilities and obligations incurred prior to the effective date of termination.
- 7.4 **Disposition of Property Upon Termination.** Upon termination of this Agreement, the Coordination Committee shall recommend the Parties distribute the assets between the successor entity and the Parties in proportion to how the assets were provided.

7.5 **Use of Data.** Upon withdrawal, any Party shall be entitled to use any data or other information developed during its time as a Party to the Agreement. Further, should a Party withdraw after completion of the GSP, the withdrawing Party shall be entitled to rely on and utilize the GSP for future implementation of SGMA within its boundaries.

ARTICLE 8: MISCELLANEOUS PROVISIONS

8.1 Indemnification.

- a. Each of the Parties shall hold harmless, defend and indemnify the other Parties, and their agents, officers and employees, from and against any liability, claims, actions, costs, damages or losses of any kind, including death or injury to any person and/or damage to property arising out of the activities of the Agreement to the extent of their respective cost share allocation.
- b. The indemnification obligation set forth in Section 8.1.a shall exclude actions or claims alleged to have occurred in full, or in part, as a result of active negligence by any indemnified Party, its officers, agents or employees and except for actions or claims alleging dangerous conditions of public property that arise out of the acts or failure to act by the indemnified Party, its officers, agents or employees which are not created by an indemnifying Party.
- c. The indemnification provisions contained in this Section include, but are not limited to, violation of applicable law, ordinance, regulation or rule, where the claim, loss, damage, charge or expense was caused by negligent, accidental or inadvertent acts of any Party, or any of their agents, officers, or employees or their performance under the terms of this Agreement.
- d. It is the intent of the Parties that where negligence or responsibility for injury or damages is determined to have been shared, principles of comparative negligence will be followed and each Party shall bear the proportionate cost of any loss, damage, expense and liability attributable to that Party's negligence.
- e. Each Party shall establish procedures to notify the other Parties, where appropriate, of any claims, administrative actions or legal actions with respect to any of the matters described in this Section. The Parties shall cooperate in the defense of such actions brought by others with respect to the matters covered in this Agreement.
- f. The indemnification obligations of this Section shall continue beyond the Term of this Agreement as to any acts or omissions occurring during this Agreement. The duty to indemnify set forth herein shall extend only to that period of time prior to a Party's withdrawal.

8.2 **Liability of Coordination Committee.** Each Party must defend, indemnify and hold harmless the other Parties from any claims, damages, injuries, losses or liabilities arising from the actions of their employees or agents taken within the scope of the authority of this Agreement.

8.3 **Amendments.** This Agreement may be amended from time to time by a unanimous vote of the Parties' respective governing boards.

8.4 **Binding on Successors.** Except as otherwise provided in this Agreement, the rights and duties of the Parties may not be assigned or delegated without a unanimous vote by the Parties. Any approved assignment or delegation shall be consistent with the terms of any contracts, resolutions, indemnities and other obligations then in effect. This Agreement shall inure to the benefit of, and be binding upon, the successors and Assigns of the Parties hereto.

8.5 **Notice.** Any notice or instrument required to be given or delivered under this Agreement may be made by: (a) depositing the same in any United States Post Office, postage prepaid, and shall be deemed to have been received at the expiration of 72 hours after its deposit in the United States Post Office; (b) transmission by facsimile copy to the addressee; (c) transmission by electronic mail; or (d) personal delivery, as follows:

If to Sutter County Groundwater Sustainability Agency:

Guadalupe Rivera
Sutter County
1130 Civic Center Blvd.
Yuba City, CA 95993
Phone: 530.822.7400
Email: GRivrea@co.sutter.ca.us

If to Butte Water District Groundwater Sustainability Agency:

Mark Orme
Butte Water District
735 Virginia St
Gridley, CA 95948
Phone: 530.846.3100
Email: MOrme@buttewater.net

If to City of Live Oak Groundwater Sustainability Agency:

Nicole Rosser
City of Live Oak
1129 D Street
P.O. Box A
Marysville, CA 95901
Phone: 530.742.5982
Email: NDelerio@yubasutterlaw.com

If to Sutter Extension Water District Groundwater Sustainability Agency:

Lynn Phillips
Sutter Extension Water District
4525 Franklin Rd.
Yuba City, CA 95993
Phone: 530.870.1712
Email: LPhillips@sutterewd.com

If to Sutter Community Services District Groundwater Sustainability Agency:

Leland Correll
Sutter Community Services District
P.O. Box 710
Sutter, CA 95982
Phone: 530.755.1733
Email: Sutterwater@aol.com

If to City of Yuba City Groundwater Sustainability Agency:

Katherine Willis
City of Yuba City WWTF
302 Burns Drive
Yuba City, CA 95991
Phone: 530.822.3264 Ext. 3311
Email: kwillis@yubacity.net

If to Reclamation District 70 Groundwater Sustainability Agency:

Andy Duffey
General Manager
Reclamation District 70
P.O. Box 129
Meridian, CA 95957
Email: aduffey@succeed.net

If to Reclamation District 1660 Groundwater Sustainability Agency:

Andy Duffey
General Manager
Reclamation District 1660
P.O. Box 35
Meridian, CA 95957
Email: aduffey@succeed.com

If to Reclamation District 1500 Groundwater Sustainability Agency:

Brad Mattson
General Manager
Reclamation District 1500
P.O. Box 96
Robbins, CA 95676
Phone: 530.738.4423
Email: Brad@sutterbasinwater.com

8.6 **Counterparts.** This Agreement may be executed by the Parties in separate counterparts, each of which when so executed and delivered shall be an original. All such counterparts shall together constitute but one and the same instrument.

8.7 **Choice of Law.** This Agreement shall be governed by the laws of the State of California.

- 8.8 **Severability.** If one or more clauses, sentences, paragraphs or provisions of this Agreement are held to be unlawful, invalid or unenforceable, it is hereby agreed by the Parties that the remainder of the Agreement shall not be affected thereby. Such clauses, sentences, paragraphs or provisions shall be deemed reformed so as to be lawful, valid and enforced to the maximum extent possible.
- 8.9 **Headings.** The paragraph headings used in this Agreement are intended for convenience only and shall not be used in interpreting this Agreement or in determining any of the rights or obligations of the Parties to this Agreement.
- 8.10 **Construction and Interpretation.** This Agreement has been arrived at through negotiation and each of the Parties has had a full and fair opportunity to revise the terms of this Agreement. As a result, the normal rule of construction that any ambiguities are to be resolved against the drafting Parties shall not apply in the construction or interpretation of this Agreement.
- 8.11 **Entire Agreement.** This Agreement constitutes the entire agreement among the Parties and supersedes all prior agreements and understandings, written or oral. This Agreement may only be amended by written instrument executed by all Parties.

IN WITNESS WHEREOF, the Parties hereto execute this Agreement on the last date written beside each Party representative's signature.

Sutter County Groundwater Sustainability Agency

By: _____

Date: _____

Name: _____

Butte Water District Groundwater Sustainability Agency

By: _____

Date: _____

Name: _____

8.8 **Severability.** If one or more clauses, sentences, paragraphs or provisions of this Agreement are held to be unlawful, invalid or unenforceable, it is hereby agreed by the Parties that the remainder of the Agreement shall not be affected thereby. Such clauses, sentences, paragraphs or provisions shall be deemed reformed so as to be lawful, valid and enforced to the maximum extent possible.

8.9 **Headings.** The paragraph headings used in this Agreement are intended for convenience only and shall not be used in interpreting this Agreement or in determining any of the rights or obligations of the Parties to this Agreement.

8.10 **Construction and Interpretation.** This Agreement has been arrived at through negotiation and each of the Parties has had a full and fair opportunity to revise the terms of this Agreement. As a result, the normal rule of construction that any ambiguities are to be resolved against the drafting Parties shall not apply in the construction or interpretation of this Agreement.

8.11 **Entire Agreement.** This Agreement constitutes the entire agreement among the Parties and supersedes all prior agreements and understandings, written or oral. This Agreement may only be amended by written instrument executed by all Parties.

IN WITNESS WHEREOF, the Parties hereto execute this Agreement on the last date written beside each Party representative's signature.

Sutter County Groundwater Sustainability Agency

By:  _____

Date: 4/13/2021 _____

Name: Dan Flores _____

Approved as to Form
County Counsel
Sutter County, California

By:  _____

Butte Water District Groundwater Sustainability Agency

By: _____

Date: _____

Name: _____

- 8.8 **Severability.** If one or more clauses, sentences, paragraphs or provisions of this Agreement are held to be unlawful, invalid or unenforceable, it is hereby agreed by the Parties that the remainder of the Agreement shall not be affected thereby. Such clauses, sentences, paragraphs or provisions shall be deemed reformed so as to be lawful, valid and enforced to the maximum extent possible.
- 8.9 **Headings.** The paragraph headings used in this Agreement are intended for convenience only and shall not be used in interpreting this Agreement or in determining any of the rights or obligations of the Parties to this Agreement.
- 8.10 **Construction and Interpretation.** This Agreement has been arrived at through negotiation and each of the Parties has had a full and fair opportunity to revise the terms of this Agreement. As a result, the normal rule of construction that any ambiguities are to be resolved against the drafting Parties shall not apply in the construction or interpretation of this Agreement.
- 8.11 **Entire Agreement.** This Agreement constitutes the entire agreement among the Parties and supersedes all prior agreements and understandings, written or oral. This Agreement may only be amended by written instrument executed by all Parties.

IN WITNESS WHEREOF, the Parties hereto execute this Agreement on the last date written beside each Party representative's signature.

Sutter County Groundwater Sustainability Agency

By: _____

Date: _____

Name: _____

Butte Water District Groundwater Sustainability Agency

By: Mark Orme

Date: 3/11/21

Name: MARK ORME

City of Live Oak Groundwater Sustainability Agency

By: Aaron Palmer

Date: 3/8/21

Name: Aaron Palmer

Sutter Extension Water District Groundwater Sustainability Agency

By: _____

Date: _____

Name: _____

Sutter Community Services District Groundwater Sustainability Agency

By: _____

Date: _____

Name: _____

City of Yuba City Groundwater Sustainability Agency

By: _____

Date: _____

Name: _____

City of Live Oak Groundwater Sustainability Agency

By: _____

Date: _____

Name: _____

Sutter Extension Water District Groundwater Sustainability Agency

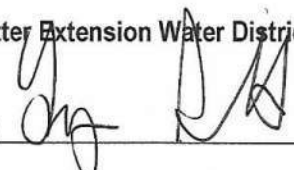
By:  _____

Date: 3-12-21 _____

Name: Lynn Phillips _____

Sutter Community Services District Groundwater Sustainability Agency

By: _____

Date: _____

Name: _____

City of Yuba City Groundwater Sustainability Agency

By: _____

Date: _____

Name: _____

City of Live Oak Groundwater Sustainability Agency

By: _____

Date: _____

Name: _____

Sutter Extension Water District Groundwater Sustainability Agency

By: _____

Date: _____

Name: _____

Sutter Community Services District Groundwater Sustainability Agency

By: Leland Correll

Date: 3/8/2021

Name: LELAND CORRELL

City of Yuba City Groundwater Sustainability Agency

By: _____

Date: _____

Name: _____

City of Live Oak Groundwater Sustainability Agency

By: _____

Date: _____

Name: _____

Sutter Extension Water District Groundwater Sustainability Agency

By: _____

Date: _____

Name: _____

Sutter Community Services District Groundwater Sustainability Agency

By: _____

Date: _____

Name: _____

City of Yuba City Groundwater Sustainability Agency

By: Diana Langley

Date: April 27, 2021

Name: Diana Langley

Reclamation District 70 Groundwater Sustainability Agency

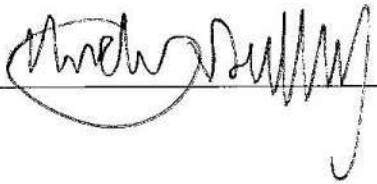
By:  _____

Date: March 3, 2021 _____

Name: Andy Duffey _____

Reclamation District 1660 Groundwater Sustainability Agency

By: _____

Date: _____

Name: _____

Reclamation District 1500 Groundwater Sustainability Agency

By: _____

Date: _____

Name: _____

Reclamation District 70 Groundwater Sustainability Agency

By: _____

Date: _____

Name: _____

Reclamation District 1660 Groundwater Sustainability Agency

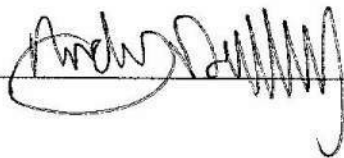
By:  _____

Date: March 9, 2021 _____

Name: Andy Duffey _____

Reclamation District 1500 Groundwater Sustainability Agency

By: _____

Date: _____

Name: _____

Reclamation District 70 Groundwater Sustainability Agency

By: _____

Date: _____

Name: _____

Reclamation District 1660 Groundwater Sustainability Agency

By: _____

Date: _____

Name: _____

Reclamation District 1500 Groundwater Sustainability Agency

By: RLM

Date: 3-8-2021

Name: Brad Mattson

This page intentionally left blank.

Appendix 4-A
Communication and Engagement Plan

This page intentionally left blank.

Communication + Engagement Plan

for the Sutter Subbasin Groundwater Sustainability Plan



Sutter Subbasin

July 2021

Prepared for Sutter Subbasin Groundwater Management Coordination Committee

Sutter County GSA
Butte Water District GSA
City of Live Oak GSA
Sutter Extension Water District GSA
Sutter Community Services District GSA
City of Yuba City GSA
Reclamation District 70 GSA
Reclamation District 1660 GSA
Reclamation District 1500 GSA

Sutter Subbasin

Communication + Engagement Plan

Last Updated July 8, 2021

How to use this Plan:

This Communication Plan provides a high-level overview of near- and long-term outreach and engagement strategies, tactics, and tools. Its purpose is to assist the Groundwater Sustainability Agencies (GSAs) of the Sutter Subbasin with stakeholder outreach and other related actions as required by the Sustainable Groundwater Management Act (SGMA) of 2014. It is presented as a working public draft and should be considered a living document that is continuously refined and updated as circumstances suggest.

Prepared by:

Woodard & Curran



Contents

INTRODUCTION	1
Sustainable Groundwater Management Act.....	1
Sutter Subbasin	2
Data and Data Evaluation	3
GOALS AND DESIRED OUTCOMES.....	3
GOVERNANCE	3
Sutter Subbasin Groundwater Management Coordination Committee (SSGMCC).....	3
GSA Boards	5
Roles and Responsibilities.....	5
STAKEHOLDER IDENTIFICATION	5
Audience Surveying	8
COMMUNICATION AND ENGAGEMENT	9
Forums.....	9
Tools	9
IMPLEMENTATION TIMELINE.....	10
EVALUATION & ASSESSMENT	11
APPENDIX A GSA Board Members and SSGMCC Members	12
SSGM Coordination Committee Members.....	12
Contributing Members	12
APPENDIX B Links to SGMA and Groundwater Information	13
APPENDIX C Media Contact List	14

The Sutter Subbasin Communication + Engagement Plan is considered a living document. It will be updated as necessary throughout GSP development, public review, and implementation.

Please direct questions to Leslie Dumas, info@suttersubbasin.org.

INTRODUCTION

Sustainable Groundwater Management Act

In 2014, California enacted the Sustainable Groundwater Management Act (SGMA) to provide a framework for long-term sustainable groundwater management across California. SGMA requires that basins designated as high- or medium-priority be managed under a Groundwater Sustainability Plan (GSP) or a coordinated GSP. Additionally, under SGMA, the California Department of Water Resources (DWR) identified 21 “critically overdrafted” basins and subbasins (COBs). The Sutter Subbasin, designated as Basin No. 5-021.62 in the DWR Bulletin 118, is part of the Sacramento Valley Groundwater Basin (DWR, 2016). The Sutter Subbasin is designated as a medium-priority subbasin by DWR and is not considered to be critically overdrafted.

As required by SGMA, GSPs must explain how the groundwater basin will reach and be kept in balance to achieve long-term sustainability. Once submitted to the State, DWR will evaluate each GSP as to how well it will achieve basin sustainability by the required deadline (2042 for GSPs submitted to the State in 2022 – see Figure 1 below). The primary goal of the GSP is to develop sustainable groundwater management practices for managing the groundwater basin or subbasin without causing undesirable results.

Figure 1: SGMA Milestones

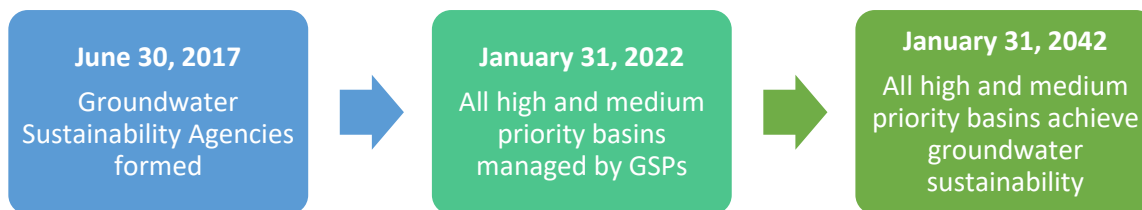

In accordance with SGMA, nine groundwater sustainability agencies or GSAs were formed with the agreement to develop one GSP for Sutter Subbasin. Sutter Subbasin GSAs include:

- Sutter County GSA
- Butte Water District GSA
- City of Live Oak GSA
- Sutter Extension Water District GSA
- Sutter Community Services District GSA
- City of Yuba City GSA
- Reclamation District (RD) 70 GSA
- Reclamation District 1660 GSA
- Reclamation District 1500 GSA

As allowed under SGMA, the Sutter Subbasin GSAs collaboratively submitted an “Alternative Plan” to a GSP in December 2016. Although the Alternative Plan was not approved by DWR, suggestions were provided that will be incorporated into the January 2022 GSP, which will

Sutter Subbasin

subsequently be updated every five years (as required by SGMA legislation). Links to additional information on SGMA can be found in Appendix B.

Sutter Subbasin

The Sutter Subbasin is generally described as being in the “central portion of the Sacramento Valley Groundwater Basin” in DWR Bulletin 118. It is bounded on the north by the Butte-Sutter County line (except for the Sutter County portion of Biggs-West Gridley Water District), on the west by the Sacramento River, on the south by the confluence of the Sacramento River and the Feather River, and on the east by the Feather River and the eastern boundary with the Sutter-Yuba County line. The Subbasin covers an area of approximately 445 square miles of the Sacramento Valley floor. Figure 2 shows a map of the Sutter Subbasin. Groundwater in the Sutter Subbasin is used conjunctively with surface water for municipal, industrial, irrigation, domestic, stock watering, frost protection, and other purposes.

Figure 2: Sutter Subbasin

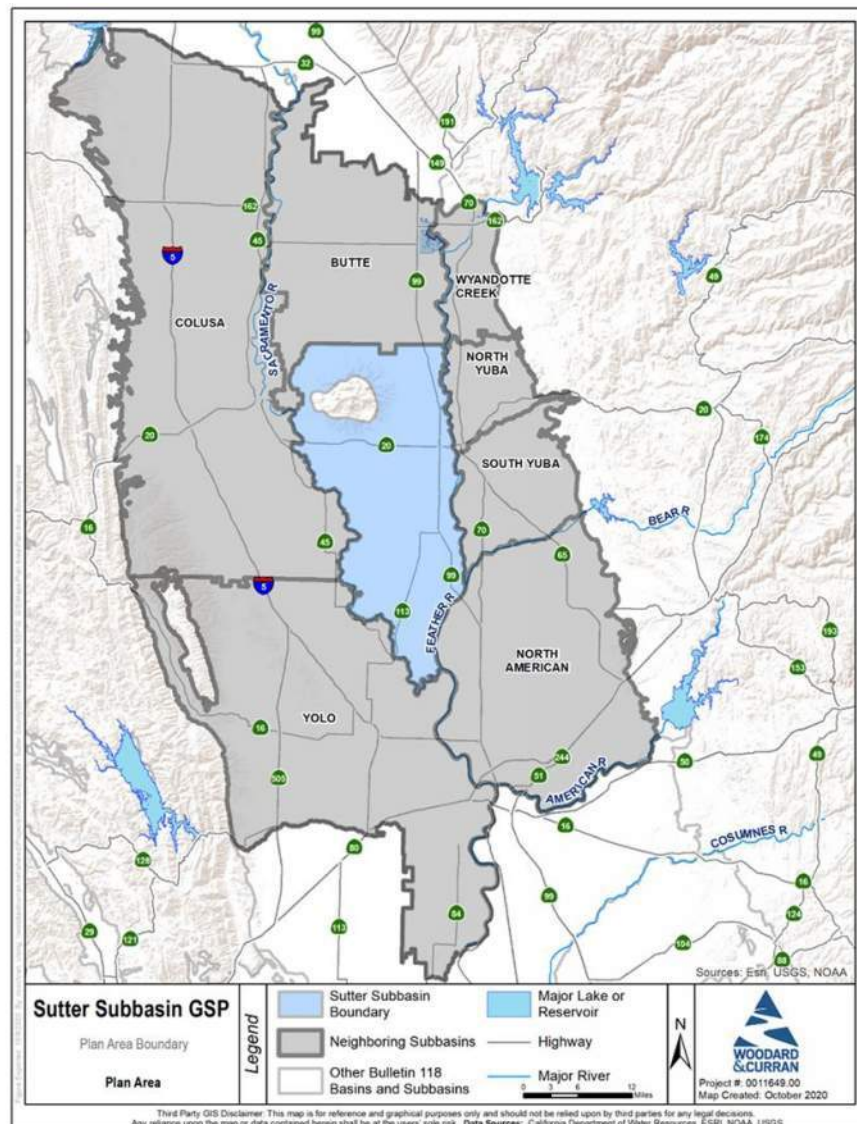

Data and Data Evaluation

The Sutter Subbasin GSP will be developed using data, modeling, and evaluations of surface water and groundwater conditions, water uses, and water management options. Public outreach and engagement will be an important element of efforts to collect, review, validate, and refine the data and evaluations that will form the basis of the GSP and future management actions.

GOALS AND DESIRED OUTCOMES

This plan has been developed to support the preparation and implementation of a well-informed GSP. This Communication Plan contains outreach strategies and methods to address effective communication with stakeholders during development of the GSP.

The desired outcome of the *Sutter Subbasin Communication and Engagement Plan* is to consider the interests of all beneficial uses/users of groundwater in addition to the diverse social, cultural, and economic elements of the population within the Subbasin. This includes stakeholder input and coordination with adjacent subbasins.

The *Sutter Subbasin Communication and Engagement Plan* has been developed to achieve the following goals:

- Conduct an inclusive outreach and education process that best supports the success of a well-prepared GSP meeting SGMA requirements.
- Utilize a variety of outreach methods to enhance public participation, make it accessible, and encourage broad participation.
- Enhance understanding and inform the public about water and groundwater resources in the Subbasin and sustainable groundwater management.
- Conduct a comprehensive, transparent outreach and education process that builds understanding and trust among the various stakeholders including local agencies, elected and appointed officials, and the general public.
- Offer public engagement opportunities that coincides with the development of technical information at key points throughout the project to establish an atmosphere of clear, concise, transparent, reliable information flow and opportunities for input.

GOVERNANCE

The Sutter Subbasin Groundwater Management Coordination Committee (SSGMCC) and the GSA Boards will work with Interested Parties and members of the public during the GSP development.

Sutter Subbasin Groundwater Management Coordination Committee (SSGMCC)

The SSGMCC was originally formed to support development of the Subbasin’s Alternative Plan. A formal agreement for



Sutter Subbasin

plan development and implementation was not prepared at this time; however, with the preparation of the GSP, the SSGMCC is currently working on a memorandum of understanding (MOU) to guide development and implementation of the Sutter Subbasin GSP long term.

The SSGMCC is comprised of voting representatives from each of the nine GSAs within the Subbasin along with non-voting representatives from non-GSA entities contributing to the development of the GSP. The SSGMCC generally follows a consensus-based decision-making

structure where each representative receives an equal voice; however, voting members provide the final decision-making structure and generally follows a simple majority vote process. The SSGMCC holds publicly-noticed regular coordination meetings to discuss GSP technical development and public outreach and engagement activities in order to prepare a GSP for ultimate adoption by the respective GSA Boards. Meeting notices and materials are posted on the Subbasin's website at <http://suttersubbasin.org>.

The SSGMCC agreed to a set of principles for engagement and operation that are intended to provide a framework of commitments among the members to work collaboratively, efficiently, and with the necessary dedication to promote the development, adoption, and submission of a SGMA compliant GSP by the statutory deadline of January 31, 2022.

Figure 3: Sutter Subbasin GSAs

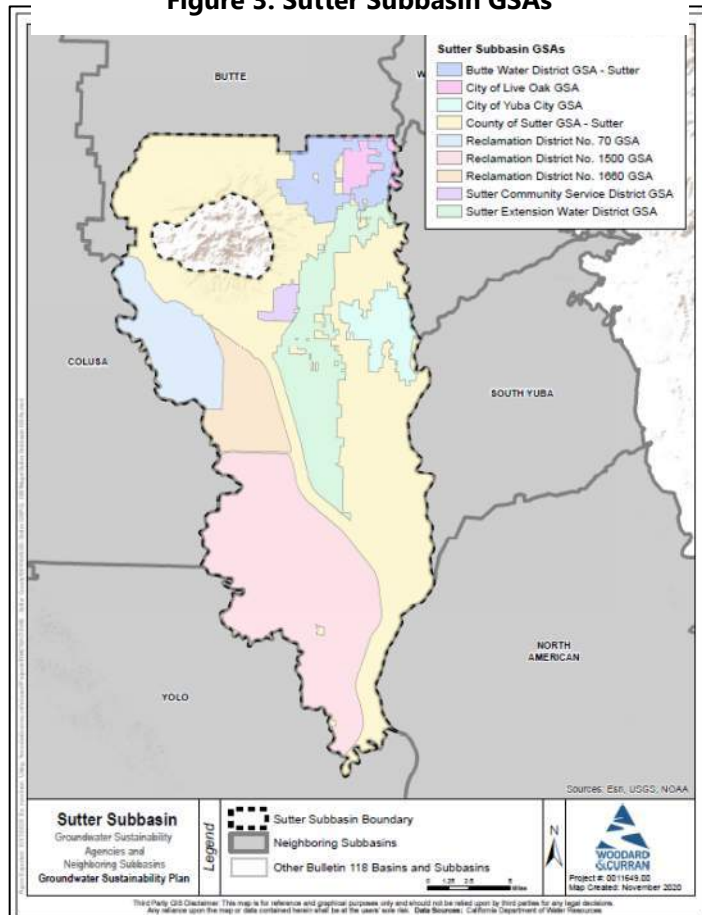

The SSGMCC is responsible for:

- Sharing feedback from their respective GSA's related to GSP development.
- Making recommendations to their respective GSAs regarding the consideration and adoption of the GSP.
- Providing or ensuring the provision of timely responses and supporting information related to GSP development to the Consultants preparing the GSP upon request in order to meet the state-mandated deadline.
- Performing and supporting appropriate and coordinated outreach to stakeholders within the Basin.
- Ultimately delivering an acceptable GSP to all GSA Boards for adoption.

GSA Boards

The respective GSA's Boards assigned their SSGMCC members to work on the day to day development of the GSP and to conduct stakeholder communication and engagement. The GSA Boards are responsible for:

- Ensuring appropriate communication and engagement is executed per the approved Communication and Engagement (C&E) Plan on behalf of their GSAs.
- Approving interim milestone to meet the mandated schedule for sustainability as set forth in the final GSP.
- Being informed about the GSP development by their designated SSGMCC members.
- Providing their respective SSGMCC members with their insights, perspectives, and opinions.
- Ultimately adopting the final GSP prior to submittal to DWR by January 31, 2022.

Roles and Responsibilities

The **GSA Boards** are the designated decision-making entity for the GSP process. Only applicable Board meetings will be noticed on the website, including for the adoption of the final GSP.

The **SSGMCC** is the primary body for providing input relative to GSP development, briefing the Sutter Subbasin GSAs Boards, and assisting with stakeholder engagement throughout the Subbasin. The SSGMCC will host public workshops in addition to their open regular meetings. Public workshops will be noticed 72 hours in advance, and agendas, meeting materials, and minutes will be available on the Sutter Subbasin website (<http://suttersubbasin.org/>). SSGM Coordination Committee members are listed in Appendix A.

Contributing Members support the SSGMCC and GSP development and implementation. These members are listed in Appendix A.

Public Input, no matter the method received (e.g., phone, email, public meeting), will be shared with the SSGMCC and planning team for consideration throughout the planning process.

STAKEHOLDER IDENTIFICATION

Public engagement includes both stakeholder coordination and general public involvement. The goal of the public engagement effort is to understand the needs of stakeholders and groundwater users in the Subbasin, increase awareness and understanding of SGMA and the GSP, and promote active involvement in the process to achieve and maintain sustainability. Stakeholders with interest in water management are the target audience for this GSP Communication Plan. The general public will be engaged throughout the planning process to share information about the Sutter Subbasin and water management decisions and solicit input to the GSP. Stakeholders are encouraged to get involved in the GSP process and may:

- Attend regularly scheduled GSA Board meetings to receive updates on the GSA process and provide input.

Sutter Subbasin

- Attend regularly scheduled SSGMCC meetings noticed at <http://suttersubbasin.org/> and provide input on the GSP development and implementation process.
- Attend topical Sutter Subbasin Public meetings that will be noticed through the individual GSA Boards, local media, and the Sutter Subbasin website to educate on SGMA and provide opportunities for input into the Sutter Subbasin GSP.

Pursuant to Section 10723.2 of the California Water Code, each GSA must consider the interests of all beneficial users and users of groundwater within the Subbasin, as well as those responsible for implementing GSPs. These interests include the following:

- Agricultural users (e.g., farmers, ranchers, and dairy professionals)
- Rural, Ag-Residential, and Domestic well owners
- Municipal well operators
- Public water systems
- Local land use planning agencies
- Environmental users of groundwater
- Surface water users
- The federal government (not limited to the military and managers of federal lands)
- Tribal Governments
- Disadvantaged communities
- Entities monitoring or reporting groundwater elevations in the Subbasin
- Holders of overlying groundwater rights
- Adjacent Subbasins including: Butte, Wyandotte, North Yuba, South Yuba, North American, Yolo, and Colusa Subbasins

A list of key audiences that have currently been identified is included in the table below. The Plan relies on the SSGMC, GSA governing boards, and the public to expand the list of interested and affected audiences as the GSP process unfolds. This Communication Plan is a living document and the stakeholder list may continue to expand if additional stakeholders are identified.

Table 1: Key Stakeholders

Category of Interest	Stakeholder Groups/Organizations
California Water Code Section 10723.3 Stakeholders	
Agricultural Users and Domestic Well Owners	<ul style="list-style-type: none"> ▪ Holders of overlying groundwater rights ▪ Small farms throughout the County
Municipal Well Operators and Public Water System Operators	<ul style="list-style-type: none"> ▪ Butte Slough Irrigation Company ▪ Pelger Mutual Water Company ▪ Tisdale Irrigation District ▪ Sutter Extension Water District

Sutter Subbasin

Category of Interest	Stakeholder Groups/Organizations
Local Land Use Planning Agencies	<ul style="list-style-type: none"> ▪ Sutter County ▪ County Agricultural Commissioners ▪ Farm Bureaus such as Butte County and Yuba-Sutter Farm Bureau ▪ Integrated Regional Water Management program – Northern Sacramento Valley ▪ Adjacent GSAs
Environmental Groundwater Users	To be identified
Surface Water Users	<ul style="list-style-type: none"> ▪ City of Yuba City
Federal Government Agencies	<ul style="list-style-type: none"> ▪ USDA Farm Services Agency ▪ U.S. Fish and Wildlife
Native American Tribes	<ul style="list-style-type: none"> ▪ Estom Yumeka Maidu Tribe of the Enterprise Rancheria ▪ Mooretown Rancheria of Maidu Indians ▪ Shingle Springs Band of Miwok Indians ▪ Pakan'yani Maidu of Strawberry Valley Rancheria ▪ United Auburn Indian Community of the Auburn Rancheria ▪ Yocha Dehe Wintun Nation
Disadvantaged and Severely Disadvantaged Communities	<ul style="list-style-type: none"> ▪ Yuba City ▪ Meridian ▪ Robbins ▪ Live Oak
Other State and Local Agencies that Monitor and Manage Groundwater Usage	<ul style="list-style-type: none"> ▪ California Department of Water Resources, Sacramento ▪ State Water Resources Control Board, Sacramento ▪ Others to be determined
Adjacent Subbasins	<ul style="list-style-type: none"> ▪ Butte ▪ Wyandotte ▪ North Yuba ▪ South Yuba ▪ North American ▪ Yolo ▪ Colusa
Additional Stakeholders	
Elected Officials	Will not be engaged at this time.
State Agencies	<ul style="list-style-type: none"> ▪ California Department of Fish and Wildlife, Headquarters, Mailing: P.O. Box 944209, Sacramento, CA 94244-2090 ▪ California Wildlife Conservation Board, c/o CDFW, 1416 9th Street, Room 1266, Sacramento, CA 95814 ▪ California Natural Resources Agency, 1416 9th St #1311, Sacramento, CA 95814 ▪ Colleges and Universities
Business Interests	<ul style="list-style-type: none"> ▪ Workers and laborers in Sutter County ▪ Colusa Produce Corporation

Sutter Subbasin

Category of Interest	Stakeholder Groups/Organizations
Local Communities and Community Organizations	<ul style="list-style-type: none">▪ South Yuba River Citizens League▪ Shady Creek Outdoor Education Foundation▪ Community Alliance with Family Farmers▪ Local Government Commission
Disadvantaged Community Organizations	To be identified
Environmental Interests/Organizations	<ul style="list-style-type: none">▪ American Rivers▪ Union of Concerned Scientists▪ Audubon California▪ Sierra Club▪ Sutter Buttes Regional Land Trust▪ The Nature Conservancy▪ Sacramento Valley Quality Coalition
Stakeholders that participated in the Alternative Plan	<ul style="list-style-type: none">▪ Individuals and corresponding contact information were identified from the previous Alternative Plan Update public workshops and stakeholder meetings.

Audience Surveying

A stakeholder survey will be incorporated into the first public workshop meeting to understand the various suggestions, concerns, and comments from stakeholders going into the process. A few questions will be interactive during the workshop. The full survey will be e-mailed to the stakeholder list and posted on the website following the workshop.

Questions include:

- Are you familiar with SGMA regulations?
- Are you currently engaged in activity or discussions regarding groundwater management in the region?
- Do you own, manage, or operate land in this region?
- Do you manage water resources? If yes, what is your role?
- What is your primary interest in land or water resources management?
- Do you have concerns about groundwater management? If so, what are they?
- Do you have recommendations regarding groundwater management? If so, what are they?
- What else do you want the planning team to know?
- Please provide contact information of anyone else that should be involved.

Responses received during and following the workshop will be documented and summarized and included in the GSP, in addition to informing the overall engagement and communication process.

COMMUNICATION AND ENGAGEMENT

Forums

Communication strategies have shifted in recent years due to the evolution of online access to information. In the midst of COVID-19, it is anticipated that the Sutter Subbasin GSP process will not be able to host as many in-person workshops as planned and therefore, flexibility with an online platform is required.

However, it is important to recognize that not all Sutter Subbasin residents have access to email and the internet. Therefore, the outreach methods include both online access and traditional means of hard copy information dissemination. Sutter County also has a substantial population that only speak Spanish or Punjabi. Therefore, supporting materials (online and hard copy) will be prepared in both languages. The GSP, however, will only be available in English. The following outreach methods will be used in order to engage stakeholders during this process:

GSA Board and SSGMCC: Utilize bi-weekly SSGMCC meetings for education and consensus building within the Sutter Subbasin. The GSA Boards will host their regular meetings, although items for the Sutter Subbasin GSP may or may not be included on regular agendas.

Public Workshops: At least four public workshops will be held during the course of the Plan creation. The public workshops are intended to inform stakeholders and the general public of GSP progress, solicit data and information to support planning and analysis for the Subbasin, and seek input on key decisions made throughout the planning process.

Public workshops will be held virtually until COVID-19 regulations allow public gatherings. Workshops will be held from 4-6 pm, outside of some normal working hours to accommodate the participation of stakeholders and the general public. If meetings return to in-person meeting, they will be rotated throughout the Subbasin to ensure broad and fair participation by members of the local public. Any changes to the location and time of public workshops will be considered to allow for meeting flexibility, as needed.

Tools

The Sutter Subbasin GSAs will use a variety of communications and engagement tools to keep the public informed and engaged in the planning process, including:

Website: The website (<http://SutterSubbasin.org/>) will house information about SGMA, the GSP process, the GSA Boards, SSGMCC, public meetings, project newsletters, project reports and studies, and groundwater data and information. The website provides options for contacting the planning team via email or in writing. The website will also provide information in Spanish and Punjabi.

The website will be developed with landing pages including a general overview of SGMA, information on outreach, scheduled meetings, SGMA resources (including links to completed deliverables and workshop materials), and the GSAs' contact information. Each page of the website will include an opportunity to sign-up for project emails. Landing pages will be also be available in Spanish at <http://suttersubbasin.org/espanol.html> and in Punjabi at <http://suttersubbasin.org/punjabi.html>.

Sutter Subbasin

Interested Parties List: The SSGMCC maintains a list of interested persons and routinely distributes meeting notices and relevant information to the stakeholders who have requested to be included. E-mail notices, the primary method of communication, will be sent to announce the availability of new materials on the website, project milestones, and workshop dates. E-mail notices will also be used to distribute the quarterly newsletters available on the website. Announcements will be distributed in English, Spanish and Punjabi as appropriate. This list will continue to grow throughout the GSP development process.

Informational Materials: Developing a variety of informational materials is critical to successful education and necessary to circulate consistent, accurate information. The SSGMCC will develop a range of materials, which may include:

- Fact Sheets and Flyers: Fact sheets to describe the GSP planning process, including, "What is SGMA" will be developed at the beginning of the GSP planning process.
- Press Releases: Press releases will also be used as a method of correspondence in local newspapers to notice for the release of the Public Draft GSP (listed in Appendix C).

These materials will be available on the Subbasin website at <http://SutterSubbasin.org/>.

Mailings and Utility Bill Notifications: Bill inserts and flyers will be used to notify the public about the GSP Planning process to encourage engagement.

Surveys: Online surveys may be periodically used to solicit stakeholder feedback and input.

IMPLEMENTATION TIMELINE

Using established GSP milestones, the GSP planning team has developed an initial roadmap for stakeholder engagement. The GSP Planning Roadmap aligns issue/topic discussions and education with the technical data as it is developed and evaluated.

The Sutter Subbasin GSP will be developed within a tight timeframe. Because the Alternative Plan was not approved by DWR, the Sutter Subbasin GSP must be adopted and submitted to DWR by January 31, 2022. The GSP is scheduled for completion in Fall 2021, providing ample time for adoption and approval by the GSA Boards. The project schedule is designed to solicit, consider, and address public and stakeholder input regarding the important planning elements, including Basin conditions, groundwater modeling, sustainability goals, management actions, implementation plan, and the draft and final GSP. The Planning Roadmap indicates the suggested timeline of stakeholder education needs, workshops and other opportunities for public review and input, and the sequencing of key issues for discussion with the SSGMCC.

Figure 4: Sutter GSP Planning Roadmap



EVALUATION & ASSESSMENT

Existing and future data associated with the planning process will be made available to the public through the public workshop series. Project maps and data tables will be presented and reviewed with stakeholders in order to garner input and feedback. Input will be gathered and included in the Draft and Final GSP as appropriate. The release of the Draft and Final GSPs will follow noticing procedures outlined in the Outreach section above.

Please direct questions to Leslie Dumas, info@suttersubbasin.org

APPENDIX A

GSA Board Members and SSGMCC Members

SSGM Coordination Committee Members

Guadalupe Rivera	Sutter County GSA
Mark Orme	Butte Water District GSA
Scott Rolls	City of Live Oak GSA
Lynn Phillips	Sutter Extension Water District GSA
Leland Correll	Sutter Community Services District GSA
Kathy Willis	City of Yuba City GSA
Andy Duffey	RD 70 GSA & RD 1660 GSA
Brad Mattson	RD 1500 GSA

Contributing Members

Andy Duffey	Meridian Farms Water Company
Jon Munger	Garden Highway Mutual Water Company & Sutter Bypass Butte Slough Water Users Association
Todd Duncan	Tudor Mutual Water Company
Dan Duncan	Feather Water District
Paul Schubert	Golden State Water Company

APPENDIX B

Links to SGMA and Groundwater Information

California Department of Water Resources, SGMA: <http://www.water.ca.gov/groundwater/sgm/>

California Department of Water Resources Critically Overdrafted Basins:
<http://www.water.ca.gov/groundwater/sgm/cod.cfm>

Department of Water Resources, Draft Guidance for GSP Stakeholder Communication and Engagement http://www.water.ca.gov/groundwater/sgm/pdfs/GD_C&E_Final_2017-06-29.pdf

Department of Water Resources, Stakeholder Communication and Engagement Digital Toolkit
http://www.water.ca.gov/groundwater/sgm/digital_toolkit.cfm

UC Davis SGMA Resources: <http://groundwater.ucdavis.edu/SGMA/>
Union of Concerned Scientists, A Guide to California's Groundwater Sustainability Plans, in English and Spanish: <https://www.ucsusa.org/global-warming/ca-and-western-states/groundwater-toolkit#.WnSt5KinFPY>

Union of Concerned Scientist, SMGA information: <https://www.ucsusa.org/global-warming/regional-information/california-and-western-states/sustainable-groundwater-management-act#.Wne0ga2ZPq0>

Community Water Center, Union of Concerned Scientists, Clean Water Fund, Stakeholder Guide for Sustainable Groundwater Management Act Implementation:
https://d3n8a8pro7vhmx.cloudfront.net/communitywatercenter/pages/52/attachments/original/1438102537/SGMA_Stakeholder_Engagement_White_Paper.pdf?1438102537

USGS, California Water Use: https://ca.water.usgs.gov/water_use/2010-california-water-use.htm

APPENDIX C **Media Contact List**

There are no media outlets, except for Sutter County News Center, that exclusively cover the Sutter Subbasin. All other media outlets listed below cover the Sutter Subbasin and surrounding areas.

Media Outlet	Website Link
ABC 10	www.abc10.com
Appeal-Democrat	www.appeal-democrat.com
CBS	sacramento.cbslocal.com
FOX 40	fox40.com
Gridley Herald	gridleyherald.com
KUBA Radio	kubaradio.com/category/local-news/
Sutter County News Center	www.suttercounty.org/newscenter
Territorial Dispatch Online Newspaper	territorialdispatch.com

This page intentionally left blank.

Appendix 4-B
List of Sutter Subbasin Stakeholders and Interested Parties

This page intentionally left blank.

Contact Name	Agency/Organization	Email	Phone Number
Adam Robin	Northern California Water Association	arobin@norcalwater.org	
AL SAEED CORPORATION LLC		alsaeedcorporation963@gmail.com	
Alexis Silveira	Sacramento Farm Bureau	alexis@sacfarmbureau.org	
Amanda Cranford	NOAA	amanda.cranford@noaa.gov	
Amy Merrill		amerill@americanrivers.org	
Andy Duffey	RD 70 GSA, RD 1660 GSA, and Meridian Farms Water Company	aduffey@succeed.net	530-696-2456
Andy Fecko	Placer County Water Agency	afecko@pcwa.net	
Angel Posey		angel@sundatagroup.one	
Anthony Roberts	Yocha Dehe Wintun Nation	aroberts@yochadehe-nsn.gov	(530) 796 - 3400
Ashlay Hazalton		ashlayhazalton36145@gmail.com	
Ashley Leonard		asteidleo@gmail.com	
Ashley Overhouse	South Yuba River Citizens League	ashley@yubariver.org	
Ben King		bking@pacgoldag.com	
Benjamin Clark	Mooretown Rancheria of Maidu Indians	frontdesk@mooretown.org	(530) 533 - 3625
Benjamin Ehinger		writingbyb@gmail.com	
Bennygek		olegivanover1@gmail.com	
Betty Peterson		peterson.betty@gmail.com	
Bill William Abbott		abbottbillwilliam@gmail.com	
Brad Arnold	South Sutter Water District	sswd@southsutterwd.com	
Brad Mattson	RD 1500 GSA	brad@sutterbasinwater.com	530-738-4423
Brett Gray	Natomas Water	bgray@natomaswater.com	
Brian Berg		brian@sgtrees.com	
Bridget Gibbons	California Department of Fish & Wildlife	Bridget.Gibbons@Wildlife.ca.gov	
Brown Torphy		Maureen79@gmail.com	
Bryant Shivers		shivers.bryant@gmail.com	
Byrce Lundberg	Lundberg Farms	bryce@lundberg.com	
Carlosreogy		carlosgrebt@gmail.com	
Chad Oliver	UC Davis School of Law	chad.i.oliver@gmail.com	
Charlotte Mitchell	Sacramento Farm Bureau	staff@sacfarmbureau.org	
Chelsea Spier	DWR	Chelsea.Spier@water.ca.gov	
Christina Buck	Butte County	Cbuck@Buttecounty.net	
Christina Hanson	Placer County	Chanson@placer.ca.gov	
Colleen	Butte County Farm Bureau	Colleen@buttefarmbureau.com	
Curt Aikens	Yuba Water Agency	caikens@yubawater.org	
Dan Duncan	Feather Water District	dd49erdd@yahoo.com	530-682-7399
Danielle V. Dolan	Local Government Commission	ddolan@lgc.org	
David Guy	Northern California Water Association	dguy@norcalwater.org	
David Runsten	Community Alliance with Family Farmers	dave@caff.org	
Dawn Carl		dawnc@sutter.k12.ca.us	
Dhoot Family Farms		DhootFamilyFarms@gmail.com	
Ellen McBride	NMFS	ellen.mcbride@noaa.gov	
Eric Jones		eric.jones.z.mail@gmail.com	
Eugenio Castro		eugenio.castro@gmail.com	
Gabriel Angelo		gafinan.c.ier@gmail.com	
Gabrielle Stadem		gstadem@lundberg.com	
Gene Whitehouse	United Auburn Indian Community of the Auburn Rancheria	bguth@auburnrancheria.com	(530) 883 - 2390
Glenda Nelson	Estom Yumeka Maidu Tribe of the Enterprise Rancheria	info@enterpriserancheria.org	(530) 532-9214
Guadalupe Rivera	Sutter County GSA	Grivera@co.sutter.ca.us	530-822-7400, ext 305
Guy Clark	Mooretown Rancheria of Maidu Indians		(530) 533 - 3625
Gwen Hartford		gwen.hartford@gmail.com	
Hunter Current		hcurrent@renewablegroup.com	
Isaac Bojorquez	Yocha Dehe Wintun Nation	ibojorquez@yochadehe-nsn.gov	(530) 796-0103

Contact Name	Agency/Organization	Email	Phone Number
J Stephens		jstep1938@gmail.com	
James Lambert		lambertj283@gmail.com	
Jim Wallace	Colusa Produce Corporation	jimwallace@ecolusa.com	
Joe Henderson	Reclamation District 1001	rd1001@syix.com	
John Amarel	Reason Farms	jamarel@reasonfarms.com	
John Nguyen		jnguyen@woodardcurran.com	
Jon Munger	Garden Highway Mutual Water Company and Sutter Bypass Butte Slough Water Users Association	jon@montnafarms.com	530-674-2837, ext 14
Jon Scott	RD 1500 GSA	jscott@sutterbasinwater.com	530-738-4423
(Jose) Pablo Ortiz Partida	Union of Concerned Scientists	jportiz@ucsusa.org	
Justine Dutra	Yuba-Sutter Farm Bureau	justine@ysfarmbureau.com	
Kathy Willis	City of Yuba City GSA	kwillis@yubacity.net	530-845-2438
Kelly Peterson	Butte County	kpeterson@buttecounty.net	
Kristen Sicke	Yolo County Flood Control and Water Conservation District	ksicke@ycfcwcd.org	
Kurt E Boeger		kanddboeger@gmail.com	
Lance Matteoli		matteolibros@matteolibros.com	
Laverne Bill	Yocha Dehe Wintun Nation	lbill@yochadehe-nsn.gov	(530) 796 - 3400
Leland Correll	Sutter Community Services District GSA	sutterwater@aol.com	530-755-1733
Leland Kinter	Yocha Dehe Wintun Nation	thpo@yochadehe-nsn.gov	(530) 796 - 3400
Lily Marra		qlouk@taikz.com	
Linda Miller		lindamillerleads@gmail.com	
Lisa Herbert	Sutter County Agricultural Commissioner's Office	lherbert@co.sutter.ca.us	
Lisa Hunter	Glenn County Water Resources Program Staff	lhunter@countyofglenn.net	
Liz Powell Skutley		liz@northbutterealestate.com	
Lynn Phillips	Sutter Extension Water District GSA	lphillips@sutterewd.com	530-673-7138
Marco Meemi		ahmedkirillov5@gmail.com	
Margaret Katy James	Department of Water Resources	Margaret.Janes@water.ca.gov	
Maria Jochimsen	Department of Water Resources	Maria.Jochimsen@water.ca.gov	
Mariana Golder		lshi@anatologygroup.com	
Mark Orme	Butte Water District GSA	morme@buttewater.net	530-846-3100
Mary Fahey	County of Colusa	mfahey@countyofcolusa.com	
Matthew Gause		mgause@westervelt.com	
Melinda Booth	South Yuba River Citizens League	melinda@yubariver.org	
Melissa Rohde		tncgroundwater@gmail.com	
Michael Smith		67mikesmith@gmail.com	
Mike Davis	American Rivers	mdavis@americanrivers.org	
Mike Edwards		leonardharris3262@gmail.com	
Mike Kennedy		janlecompte7162@gmail.com	
Mike MacAdam		davidmitchell7162@gmail.com	
Nick Wilson		nick@saaytext.com	
Paul Gosselin	Butte County	pgosselin@buttecounty.net	
Paul Schubert	Golden State Water Company	Pschubert@gswater.com	
Regina Cuellar	Shingle Springs Band of Miwok Indians	rcuellar@ssband.org	(530) 387 - 4970
Reid Robinson		reid@sgtrees.com	
Rob Swartz	Sacramento Groundwater Authority	rswartz@rwah2o.org	
Roberta Firoved	California Rice Commission	rfiroved@calrice.org	
Roger Cornwell	Reclamation District 108	rcornwell@rivergardenfarms.com	
Samantha Arthur	Audubon California	sarthur@audubon.org	
Scott Matyac	Yuba Water Agency	smatyac@yubawater.org	
Scott Rolls	City of Live Oak GSA	srolls@rarcivil.com	530-895-1422
Scott Tucker	Pelger Mutual Water Company	pelgerwater@comcast.net	
Sharla Stockton	Glenn County	sstockton@countyofglenn.net	

Contact Name	Agency/Organization	Email	Phone Number
Stacy Ann Silva	New Current Water and Land, LLC	ssilva@newcurrentwater.com	
Stan Anderson	Agriculture	stnanrsn@comcast.net	
Stephen Mitchan		ShanCarney@gmail.com	
Tim O'Halloran	Yolo County Flood Control and Water Conservation District	tohalloran@ycfcwcd.org	
Tina Goodwin	Pakan'yani Maidu of Strawberry Valley Rancheria	tinagoodwin@washoetanf.org	(617) 417-2166
Toby Moore	Golden State Water Company	tobymoore@gswater.com	
Todd Duncan	Tudor Mutual Water Company	jtdfwd@yahoo.com	530-682-7399
Todd Manley	Northern California Water Association	tmanley@norcalwater.org	
Trevor Joseph	City of Roseville	Tjoseph@roseville.ca.us	
Vada Duve		RudolphFriar@gmail.com	
William Jow	City of Yuba City	Wjow@yubacity.net	
Wooley Farms		wooleyfarms@msn.com	
Xerónimo Castañeda	Audubon California	Xeronimo.Castaneda@audubon.org	
	Yuba-Sutter County Farm Bureau	yuba-sutterfb@sbcglobal.net	
		andy@sillerhelicopters.com	
		cruz mora5149@gmail.com	

This page intentionally left blank.

Appendix 4-C
Comments Received and Comment Log

This page intentionally left blank.

Sutter Subbasin GSP Public Draft
Tracking of Comments Received as of November 15, 2021

Letter No.	Commenter	Commenter Organization	Comment No.	Date Received	Page	Section, Figure, or Table	Document	Comment
1	Ben King	Member of the Public, Colusa Resident	1	7/25/2021			Draft HCM Section	I just reviewed the Draft HCM for the Sutter Basin and it seems the Monitoring Network used for the Groundwater Quality assessments is not representative of the historical and empirical data that I have found in my research. The earliest groundwater quality data that I have found for the Sutter Basin was part of the Sutter-Yuba County Investigations which was published by the State Water Resources Board in 1952. Some of the observations go back to 1947 and 1949. This report was prompted by the report of saltwater intrusion in the fresh water aquifer. On Page 38 of the Sutter Yuba County investigation the report states "Furthermore, when the water table is lowered by heavy irrigation pumping it is probable that upward movement of the brines is accelerated." It is my understanding that the concern about upward movement of salt water brines prompted which had existed since the 1930's prompted the transition from ground water supply to surface water supply by the local irrigation district. I have attached the cover for the report so that your consultants can access the report from the UC Davis Library and also included Table 20 of the Report which clearly shows an increase in EC levels southward south of the Buttes in the 3E and 2E Range south of the Sutter Buttes. You can see that the problem is most pronounced in the T12N/R2E where there is a Boron observation of 10.8 and a EC observation of 10,000
1	Ben King	Member of the Public, Colusa Resident	2	7/25/2021			Draft HCM Section	Attached is an excerpt of the 1971 Thesis by George Cutrin "Hydrology of the Sutter Basin, Sacramento Valley, California." I have attached the Appendix table with the water quality observations which were the basis of his report. You can see the same consistent elevated TDS/EC and Boron observations near T14N/2E and T14N/R3E. There are 4 TDS observations greater than 5000 and two Boron observations of 10.8. Magnesium and Chloride observations were also elevated. The TDS measurements would seem consistent with the 10,000 and 8,600 EC observations in the Sutter-Yuba Investigation Table and the Boron is the same 10.8.
1	Ben King	Member of the Public, Colusa Resident	3	7/25/2021	5/1/1939	Figure 19	Draft HCM Section	Regarding the discussion regarding Arsenic, the draft HCM does not seem to reflect the observations on Figure 19 of the GSP. The HCM seems to indicate only one observation above 100 rather than the 3 observations about 100 u/gL on Figure 19. Overall, the discussion does not highlight the potential health risk of the elevated observations over the USEPA MCL in public supply systems. The multi-completion well nearest the City of Sutter shows an observation of 93 u/gL at 554 feet and the multi-completion well near Robbins has an observation of 84 at 695 feet. There is no observation for the water quality at Meridian which should be a concern since the public supply system for Grimes has an observation of 24 u/gL and because there have been elevated observations for wells on the south side of Colusa. In the report that is cited in the HCM "Stratigraphic Analysis and Hydrogeologic Characterization of Cenozoic Strata in the Sacramento Valley near the Sutter Buttes" Springhorn stated the following on page 164: "Concentrations of arsenic 27 spatially and depth distributed samples from DWR multi-completion monitoring wells ranged from < 0.1 to 370 ug/l. Concentrations in 15 of the samples exceeded the USEPA current drinking water MCL of 10 ug/L, and 90 percent of groundwater samples collected from wells screened in Rampart volcanoclastic have arsenic concentrations exceeding the MCL." My comment regarding the Arsenic discussion of the HCM is that the text of the Arsenic discussion in Springhorn's report is more consistent with the necessity to highlight the gravity of the health risk of arsenic above the USEPA MCL rather than the current discussion which does not clearly state the number of elevated occurrences nor does it highlight the potential risks to Sutter County public supply systems.
1	Ben King	Member of the Public, Colusa Resident	4	7/25/2021			Draft HCM Section	Attached is the 2014 USGS Paper 1358 "Water Quality in Basin-Fill Aquifers of the Southwestern United States: Arizona, California, Nevada, New Mexico and Utah, 1993-2009". According to the statistical model described on Page 58 of the Paper, the presence of arsenic contamination is as predicted due to the presence of volcanic rocks and groundwater with high observed levels of pH and especially under the anoxic conditions of the connate seawater surrounding the Sutter Buttes. On Page 54 of this USGS Report it states: "The interaction of arsenic with metal oxides, particularly iron oxide is one of the most important processes by which groundwater can become enriched or depleted in arsenic. When geochemical conditions favor arsenic release (desorption) from oxide surfaces, groundwater concentrations are higher than when geochemical conditions favor arsenic attachment (adsorption) to oxide surfaces... If the pH is greater than 8, arsenic tends to desorb from the iron oxides and dissolves into the groundwater. Under anoxic conditions, iron oxides dissolve and release iron and arsenic into the groundwater regardless of pH." Additionally, contrary to the conclusion reached in the HCM, the translocation of salt water and arsenic contamination should be expected as it has been observed for the public supply system of Albuquerque New Mexico. The 2014 USGS Paper 1358 focused on Southwestern water quality also highlights the likely translocation of arsenic via Fault systems on such as the Willows Fault when it highlighted the observed translocation of arsenic contamination in the Rio Grande Basin on Pages 56 and 57 of the Paper. According to the Paper - "The highest concentrations of arsenic in groundwater in the Middle Rio Grande Basin are associated with volcanic rocks... and with fault zones through with deep, mineralized groundwater rises." Comparing this to the situation in Colusa and Sutter Counties it would make sense to infer that the source of the arsenic contamination in Princeton is related to the source of the contamination in the abandoned well Del Oro well on the south side of Colusa which is also related to the source of the contamination in Grimes and also the source for Robbins. All of these points of observed contamination lie close to the southeasterly path of the Willows Fault and are aquifers where salt water brines occupy lower stratas.
1	Ben King	Member of the Public, Colusa Resident	5	7/25/2021			Draft HCM Section	My last comment concerns the lack of data on the portion of the Sutter Subbasin between the Sutter Buttes and the City of Colusa. As I mentioned I am particularly concerned about the potential for arsenic contamination affecting the public supply system for the City of Colusa. My first observation is that I do not believe the HCM is working on the best available data for BFW levels. As you can see in the Springhorn attachment the DWR has updated the work done by Berkstresser in 1973. Springhorn, Hightower, Bedegrew and Bonds from the DWR presented a poster board with updated BFW contours at The Geological Society of America in May 2013. The BFW levels in the HCM should include this update and reference this work. Secondly the HCM should include consider the water quality data from the USGS Gamma site EASC21 which appears to be on the Butte Slough immediately north west of the Sutter Buttes. The water quality observations in this well support the presence of connate sea water and anoxic conditions in general. As attached, the USGS Report prepared in cooperation with the California State Water Resources Control Board "Ground-Water Quality Data in the Middle Sacramento Valley Study Unit, 2006 – Results from the California Gama Program" Data Series 385. On Figure 3 located in the Methods section Page 7, the location of EASC21 observation well is shown to be slightly northwest of the Sutter Buttes and very close to the Willows Fault. This well with a well depth of 369 feet has extraordinary sample observations indicating the likelihood of upwelling of connate water into the fresh water aquifer. The specific conductance of this well was 2380 uS/cm on Table 4. On Table 9 the Chloride Level was 626 mg/l and the Total dissolved solids was 1290. On Table 10 Arsenic was 80.5 ug/l, Boron was 1,010 ug/l. Perhaps most interesting was the results for Table 14 – it was the only well with a positive reading (all others had negative numeric observations) for g130 of dissolved carbonates with a reading of 5.57 (per mil). Given these water quality observations, I would encourage the consultants working on the HCM to reconsider the level of detail in the HCM regarding the area between the Sutter Buttes and the portion Colusa County east of the Sacramento River. In my opinion it is unfortunate that this area has been carved up into 3 subbasins by BBM modifications but some one has to address the complexity of the geology of the Colusa Dome and the likelihood the connate salt water and arsenic is moving vertically and laterally via the Willows Fault and or the Sutter Buttes Rampart.
1	Ben King	Member of the Public, Colusa Resident	6	8/5/2021			Draft HCM Section	I wanted to make one final comment on the draft HCM for the Sutter Subbasin. While I see you have included another Figure from Harwood and Helley, I would like to suggest that you also include Figure 12 from their 1987 USGS Paper. I would like to suggest that the relative locations of the Reverse Fault portion of the Willows Fault and the location of the Colusa Dome is important and the fact that part of the Reverse Portion is inferred because of its relative location to the City of Colusa. The location of the Colusa Dome and assumed depth is also important since it is rather shallow at its peak – 1000 ft. There is a lot going on here – not to mention the intersection of all of this with the Sacramento River and related hydrology. Since this is the most detail of this complex geology with relative locations I am suggesting that this Figure as attached be included in the HCM. The cross section at the bottom of the figure is also informative because it identifies the type of rocks and locations in context with the volcanic structure and Colusa Dome in particular. It highlights how shallow the Tertiary Rocks are to the west towards Colusa in particular.
2	Ben King	Member of the Public, Colusa Resident	7	8/27/2021		Table 5-7	Draft Groundwater Conditions Section	Table 5-7 Comments: 1: The Draft Groundwater Conditions Chapter appear to be a material deviation from the breadth of the previous work done by Woodward and Curran in the Sutter Subbasin GMP. Rather than build upon the breadth of data presented in the GMP and update the GMP with the work of Springhorn and the recent work of the USGS by Susan Thiros and Laura Bexfield regarding Water Quality in Basin Fill Aquifers and Groundwater Availability in the Central Valley, this Draft seems to be beholden to the GEI Alternative Plan and attempt to limit the data set and new research to justify the constraints of the GEI Alternative Plan. The GEI Alternative Plan appears to an advocacy document intended to try to exempt the Sutter Basin from material SGMA requirements. I would encourage Woodward and Curran to expand the data set and update the work done in the Sutter GMP in its development o of the GSP for the Sutter Subbasin. 2 On Page 45 of the Draft the following statement is made: " Median concentrations of arsenic have decreased since 1952 and most recently are below the Primary MCL". There is no basis for this statement - what could be said is – Based on a selected data set of 28 recent measurements over a selected 7 year period. the median observation has decreased since 1952 when compared to the median of the 115 observations analyzed for the last 60 years. Furthermore you could say that the median observation of the data set for selected 3 year period was dropped from being nearly twice the allowed USEPA MCL to 70% of the USEPA MCL!! What is not discussed is how could this happen? After decades of upwelling, redox, metal oxide desorption, increased groundwater pumping due to conversion to permanent plantings the Sutter Subbasin experience a 63% decline in groundwater arsenic contamination!. What is in the water that seems to indicate that principles of redox and arsenic desorption seem to have changed over the last 7 years? Why does the Table compare a 56 year period with 77 data points to a 3 year period with 38 data points to a 7 year period with 28 data points? 3. Regarding the data set the source is noted as GAMA (SWRCB,2021). What part of GAMA is this – there is no notation of this source in the Reference Section. GAMA has a history back to 2004 and a change of focus in 2012. Was the 1952-2008 data from GAMA and what part of GAMA? 4, It appears that most of the data cites in 5-81,82,83 and 84 are intended to be from the 2008 Sacramento Valley GAMA publication but this report does not appear to be cited nor do the measurements presented on this Figures appear to be correct in all cases. Was it intended to use the 2008 USGS publication for the reported observations? If so – perhaps this report should be cited and put in the Reference Section. 5. The water quality figures of the Sutter Subbasin GMP cite USGS (GAMA), DWR, SEWD, DHS, FAQ and the USEPA. It seems that Table 5-7 is limited to the USGS (GAMA) via the SWRCP data set? How about the SWRCB data set for MCL violations for public water systems. Are the water quality observations for the Barry School well near Yuba City or the Sutter County Public Water Systems included in Table 5-7? Specifically: <ul style="list-style-type: none"> •Barry School Well . In 2015 Tom Butcher Director of Maintenance said that the arsenic contamination problem is not solved and is giving bottled water to students (Arsenic in California Drinking Water Page 16 , September 2016) •Sutter Co. WWD#1 (Robbins) Public Water System S100107 •Wildwood Mutual Water Company PWS 5100109 •City of Live Oak PWS 5110001 •Yuba City Groundwater- Region 2-3 PWS 511003 6. On Page 5-46, it is stated " ..water quality objectives identified in Table 5-7 for the purpose of using a common metric for the highest beneficial use, which is drinking water." Shouldn't the fact that Sutter County has entered in an agreement with the USEPA regarding Robbins be discussed as a current condition. How about the fact that students were given bottled water outside of Yuba City as late as 2015? How about the fact the USEPA has cited the portion of the sewage system dependent on groundwater for an arsenic violation? The Primary MCL violation for the City of Live Oak. The Arsenic violation for the Wildwood water system near Yuba City? None of this is mentioned in the Draft? Were any of these measurements included among the 28 measurements referenced for the 2013-2020 period of Table 5-7? 7. Figure 5-81 The grouping of the observations for Rice 20 and Rice 01 should be separated since the Rice 01 observations are material and extraordinary. It should be noted that that Rice 01 had and arsenic observation of 8 ug/L which is close to the USEPA MCL even though it has a well depth of 50 feet. The TDS level is reported to be 7390 which is again extraordinary and indicates that arsenic desorption is likely to be occurring with a high pH and high TDS. It is also extraordinary that the TDS level for Rice 20 is more than 10 times less even though there are near the same latitude. Perhaps this could have something to do with the up-whelling and possible transmission of connate water via the Willows Fault as the Sutter Subbasin elevation declines southwardly. Please note that the TDS levels reported for 2006 GAMA observations are different from those Table 9 Page 60 of the USGS 2008 Report. Also please separate Rice 01 with its own data box – there is plenty of room on the lower right side of the Figure on top of the North American basin portion of Figure 5-81. 8. Figure 5-83 There is material omission by not including GAMA EASC 21. The 2006 observations were : Arsenic 80.1 ug/L Boron 1,010 ug/L (Table 10 Page 61 USGS GAMA 2008) and TDS 1290 (Table 9 Page 58 USGS GAMA 2008). For the EASC 19 there is a 2006 reading of 96 on Table 10 but the data cited is a 2001 observation. The same is true for TDS – the 2006 observation is 306 . For the companion 15N well there is no data mentioned for arsenic – perhaps there should be a NA if not available. For EASC 29, the TDS level reported on Table 9 appears to be 297 which is different than the 2006 reported observation by a small amount.

Sutter Subbasin GSP Public Draft
Tracking of Comments Received as of November 15, 2021

Letter No.	Commenter	Commenter Organization	Comment No.	Date Received	Page	Section, Figure, or Table	Document	Comment
2	Ben King	Member of the Public, Colusa Resident	8	8/27/2021			Draft Groundwater Conditions Section	<p>Here are the 2nd part of my Comments on the Draft Chapter:</p> <p>1. Generally the Draft Chapter ignores the geology and geochemistry of the Sutter Buttes volcanic structure and Rampart as well as the tectonic features of the Willows Fault. The statement in the box for Figure 5-48 on the GEI slide from the Alternative Plan highlights the deficient perspective of the Draft Chapter. The Basin Boundary Modifications approved by the DWR to incorporate the Sutter Subbasin Project Area rightly with the Sutter Subbasin as a whole was material and extremely consequential. There is extensive empirical data and research to take a position strongly disagreeing with the conclusion made in the following statement. "Such Modifications (referring to the 2019 BBM) have not resulted in material changes that would alter understanding of basin conditions." The BBM Modification added: (1) an 2 million year old volcanic structure at the valley floor of an in-fill basin, (2) connate sea water that is upwelling around the volcano and likely moving laterally down the decent of the Valley floor and possibly via the fault structure and (3) an active fault in the Willows Fault that is located between the Sutter Buttes Rampart and the City of Colusa that has a spur that goes under the Sacramento River and under the City of Colusa with the major fault line moving through the length of the entirety of the Sutter Subbasin mostly within the major flood zone of the Sutter Bypass and (4) the geologic structure of the Colusa Dome with shallow and uncertain vertical aquifer depths.</p> <p>2. Some empirical observations to consider: (a) GAMMA Site EASC 21 with elevated trace metal observations and water chemistry that may indicate the upwelling of anoxic sea water into normal well depths located on the banks of the environmentally important Butte Creek, (b) a BBM comment that the domestic well for the Colusa Shooting Club on Laux Road has a reverse osmosis filter to treat well water and (c) a report from a local landowner on Laux Road that a neighbor brought up saltwater from a new 500 foot well that killed fish.</p> <p>3. Refer to "Sutter Buttes – The Lone Volcano in California's Great Valley" USGS – Reducing the Risk From Volcano Hazards by Brian Hausback and Patrick Muffler March 2011. Understanding the unique location of the Sutter Buttes in the Sacramento Valley watershed should inform GSP development.</p> <p>4. Refer to "Geochemistry of Ground Water in the Sacramento Valley, California by Laurence C. Hull, USGS Publication 1984 - The Sutter Buttes are identified as one of 8 unique Geomorphic Units on Page B4. On Page B10 – "The Sutter Basin facies is tied with the south alluvial fan facies for the highest average dissolved solids concentration. This facies is also high in sodium, chloride, bicarbonate, potassium and boron. The effect of reducing concentrations are evident in the relatively higher concentrations of iron, manganese, and arsenic in this area, all of which are more soluble in reducing environments (Garrels and Christ, 1965). The very low average nitrate concentration in this facies is also indicative of reducing conditions, where nitrate can be removed by denitrification reactions. The origin of the high dissolved-solids water is thought to be connate marine water moving upward along fault lines created when Sutter Buttes was emplaced (Curtin, 1971) " Got to take the shot at conclusions based on Table 5- 7 in the Draft Chapter – REALLY????</p> <p>5. Refer to "Hydrogeology of the Sutter Basin, Sacramento Valley< California by George Curtin. Master Thesis, University of Arizona – this is the reference for Hull. Can one publish a Draft for Groundwater Conditions for the Sutter Basin and not discuss the findings of a Hydrology Professor about the Sutter Basin?</p> <p>6. Refer to "Late Cenozoic Tectonism of the Sacramento Valley, California by David Harwood and Edward Helley USGS 1987 See Page 16 for the discussion regarding the relationship between the Willows Fault and the Colusa Dome. The vertical depths of the groundwater aquifer around the Sutter Buttes and on top of the Colusa Dome structure should be addressed in the Draft Chapter</p> <p>7. Refer to "Stratigraphic Analysis and Hydrogeologic Characterization of Cenozoic Strata in the Sacramento Valley Near the Sutter Buttes" by Steven Taylor Springhorn, Masters Thesis, CSU, Sacramento 2008. Refer to the discussion on Page vii of the Abstract "The presence of brackish water in these deeper aquifers combined with upward vertical gradients creates the potential for continued upward migration of brackish water into overlying fresh water aquifers, or upconing beneath areas of pumping. Prolonged well pumping in these areas is likely to result in regional water quality degradation and may ultimately reduce the thickness of fresh groundwater in the Sacramento Valley" On Page 163 "Data analyses suggest there is a connection between elevated arsenic concentrations in groundwater and the presence of the Sutter Buttes Rampart volcanoclastic material (which is derived from silicic and intermediate volcanic rocks)."</p> <p>8. Refer to "Water Quality in Basin-Fill Aquifers of the Southwestern United States: Arizona, California, Colorado, Nevada, New Mexico and Utah, 1993-2009" by Susan Thiros, Angela Paul, Laura Bexfield and David Anning USGS 2014 See the similarity of the Sutter Subbasin to the Middle Rio Grande Basin on Page 56 " Groundwater circulating at depth in the Middle Rio Grande Basin has high concentrations of arsenic, chloride and other elements. This deep ground water comes into contact with shallower groundwater where it flows upward, primarily along fault zones throughout the basin." See Page 59 regarding the predictive model described on Page 58 where high concentrations of arsenic are predicted in an topographical area like Robbins = " Arsenic concentrations greater than the MCL are more likely to occur in basin lowlands than in other parts of the basin because of longer residence time in the aquifer and geochemical reactions between the groundwater and arsenic-bearing sediment."</p>
2	Ben King	Member of the Public, Colusa Resident	9	8/27/2021		Section 5.2.2.3	Draft Groundwater Conditions Section	<p>Comment Regarding Section 5.2.2.3 Groundwater Trends</p> <p>1. The SWRB Report "Sutter-Yuba Counties Investigation" SWRB Bulletin No. 6 1952 made clear that the upward movement of saline water is not a trend but a well known fact. This report based on work primarily done in 1949 and published in 1952 made this statement on Page 32 under Quality of Water. "With respect to ground water supplies, however (compared to surface water discussed in the previous sentence) , salinity sufficient to impair use of the ground water for irrigation, domestic, and many industrial uses has been observed at scattered wells throughout the area for many years". After approximately 80 years maybe it is time to stop calling it a trend and focus on the trend in degraded groundwater quality caused by upwelling?</p> <p>2. Refer to "Effects of Natural and Human Factors on Groundwater Quality of Basin-Fill Aquifers in the Southwestern United States – Conceptual Models for Selected Contaminants" by Laura Bexfield, Susan Thiros, Jena Huntington, and Tim McKinney USGS 2011 Refer to Page 54 for the discussion regarding TDS. Refer to Page 59 for the discussion regarding Arsenic See Page 44 " How Redox Conditions are Determined " regarding the important role Redox conditions have on water quality. Based off approximately 80 years of connate saline water redox – Bexfield's report can provide great scientific analysis to be included in the Draft Chapter regarding Groundwater Conditions.</p>
2	Ben King	Member of the Public, Colusa Resident	10	8/27/2021		References List	Draft Groundwater Conditions Section	<p>Comments Regarding the Reference List.</p> <p>Please refer to the reports referenced for the full citation for suggested references to be included and analyzed when completing the final draft of the Chapter.</p> <p>Since this Draft Chapter is about the Sutter Subbasin the previous work specifically focused on the Sutter Subbasin should have the respective findings discussed and analyzed in the Chapters of the GSP. There are three reports that should be referenced:</p> <p>1. Sutter-Yuba Counties Investigation 2. Hydrogeology Of The Sutter Basin, Sacramento Valley, California 3. Stratigraphic Analysis And Hydrogeological Characterization of Cenozoic Strata in the Sacramento Valley Near the Sutter Buttes</p> <p>The Following USGS Papers should be referenced:</p> <p>1. Hull – Geochemistry of Groundwater in the Sacramento Valley, California 1984 for the geochemical foundation of the influence of the Sutter Buttes on the Sutter Basin groundwater quality 2. Harwood and Helley – Late Cenozoic Tectonism of the Sacramento Valley, California 1987 for the foundational analysis of the Willows Fault and the interrelationship with the Colusa Dome 3. Thiros et al. – Water Quality in Basin-Fill Aquifers of the Southwestern United States: Arizona, California, Colorado, Nevada, New Mexico and Utah, 1992 -2009, 2014 for the discussion on the chemical basis of desorption of arsenic and the lateral movement of connate water and arsenic via faults 4. Bexfield et. al – " Effects of Natural and Human Factors on Groundwater Quality of Basin-Fill Aquifers in the Southwestern United States, 2011 for the discussion on the redox and saline unphwelling identified in the Sutter-Yuba Counties Investigation. Also for the discussion regarding arsenic contamination. When referring to this Report consider the fact that these hydrochemical processes have been occurring at least since the 1940's and for "many years prior" to the report in 1952. Perhaps a 100 years of Redox in the Sutter Subbasin?</p>
3	Kevin Thomas	Department of Fish and Wildlife, North Central Region	11	11/8/2021	5-169	5.2.7	Public Draft GSP	<p>Comment #1 – Interconnected Surface Water Systems (5.2.7 Interconnected Surface Waters; starting page 5-169): The GSP does not include an estimate of the quantity and timing of depletions of interconnected surface water systems as required by 23 CCR § 354.16(f).</p> <p>a. Issue: The GSP identifies the Feather River, Sacramento River, and Sutter Bypass as interconnected surface waters and assesses whether stream segments are primarily gaining, losing, or mixed. However, the GSP does not include information related to the quantify and timing of depletions from these interconnected surface waters as required by 23 CCR § 354.16(f).</p> <p>b. Recommendation: The Department recommends that the GSP include a table quantifying the volume of surface water depletions, by month, for all interconnected surface waters identified within the subbasin.</p>
3	Kevin Thomas	Department of Fish and Wildlife, North Central Region	12	11/8/2021	5-173	5.2.8	Public Draft GSP	<p>Comment #2 – Groundwater Dependent Ecosystems (5.2.8 Groundwater Dependent Ecosystems; starting page 5-173): Groundwater dependent ecosystem (GDE) identification, required by 23 CCR § 354.16(g), is based on methods that risk exclusion of ecosystems that may depend on groundwater.</p> <p>a. Issues:</p> <p>i. Depth to Groundwater Threshold: The GSP relies on a groundwater level threshold of 30-feet below the ground surface (bgs) to screen potential GDEs within the subbasin. However, mature Valley Oak (Quercus lobata) can access groundwater up to 80 feet bgs (Howard 1992, Lewis & Burgy 1964). The use of a 30-foot threshold may incorrectly exclude Valley Oak communities within the subbasin from further consideration as a GDE. Additionally, the GSP does not specify if the groundwater level data used for the depth to groundwater analysis is based on spring or fall groundwater measurements.</p> <p>b. Recommendations:</p> <p>i. Depth to Groundwater Threshold: The Department recommends the GSP update the methodology for classifying GDEs to reflect accurate maximum potential rooting depth for Valley Oak communities. For areas of Valley Oak within the subbasin, the Department recommends the GSP apply a threshold of 80 feet bgs as the maximum depth at which the potential GDE could access groundwater. The Department accepts the use of a 30-foot threshold for other potential GDE areas within the subbasin that do not contain Valley Oak. The GSP should also explicitly identify which groundwater level measurements were used for the depth to groundwater analysis; the Department recommends the analysis rely on spring, or seasonal high, groundwater levels to be inclusive of potential GDEs.</p>

Sutter Subbasin GSP Public Draft
Tracking of Comments Received as of November 15, 2021

Letter No.	Commenter	Commenter Organization	Comment No.	Date Received	Page	Section, Figure, or Table	Document	Comment
3	Kevin Thomas	California Department of Fish and Wildlife, North Central Region	13	11/8/2021	5-173	5.2.8	Public Draft GSP	<p>Comment #2 – Groundwater Dependent Ecosystems (5.2.8 Groundwater Dependent Ecosystems; starting page 5-173): Groundwater dependent ecosystem (GDE) identification, required by 23 CCR § 354.16(g), is based on methods that risk exclusion of ecosystems that may depend on groundwater.</p> <p>a. Issues: ii. GDEs Near Surface Water: The GSP eliminates potential GDE areas located within 150 feet of surface waters, within 150 feet of irrigated rice paddies, and within 50 feet of other irrigated croplands, Fish and Wildlife Service-irrigated land, and State irrigated land. This GDE-elimination method may disregard a GDE’s adaptability and opportunistic approach to accessing water in which vegetation and ISW may rely on both surface water and groundwater across seasons and years.</p> <p>b. Recommendations: ii. GDEs Near Surface Water: The Department recommends that the GSP err on the side of inclusivity of potential GDEs until there is site specific evidence that the overlying ecosystem has no significant dependence on groundwater across seasons and water year types. This means not ruling out potential GDEs because they are proximate to surface water.</p>
3	Kevin Thomas	California Department of Fish and Wildlife, North Central Region	14	11/8/2021	5-173	5.2.8	Public Draft GSP	<p>Comment #2 – Groundwater Dependent Ecosystems (5.2.8 Groundwater Dependent Ecosystems; starting page 5-173): Groundwater dependent ecosystem (GDE) identification, required by 23 CCR § 354.16(g), is based on methods that risk exclusion of ecosystems that may depend on groundwater.</p> <p>a. Issues: iii. GDE Identification by Year: The GSP assesses potential GDE areas identified in the Natural Communities Commonly Associated with Groundwater (NCCAG) dataset across three years: 2013, 2015, and 2017. For each year, the GSP removes NCCAG areas based on the depth to groundwater and proximity to surface water/irrigated lands elimination criteria; remaining NCCAG areas are identified as “potential GDEs.” This process essentially creates three different sets of potential GDE locations within the subbasin, one for each of the years evaluated, intended to represent a range of dry to wet years. It is unclear whether the GSP requires an area to be identified as a potential GDE in all three of the years evaluated to be retained as a GDE for monitoring and management actions in the GSP, or if an area identified as a potential GDE in one or two of the three years would be retained as a GDE. For instance, an area identified as a potential GDE in 2017, a wet year, may not have had access to groundwater supplies during 2015, a critically dry water year in which groundwater levels reached historic lows. A lack of groundwater access during dry years does not negate an area’s status as a GDE; if GDE areas must be confirmed across all three representative water years to be managed in the GSP, the plan’s methodology may incorrectly eliminate potential GDEs based on their inability to access groundwater at a single point in time during a critically dry year.</p> <p>b. Recommendations: iii. GDE Identification by Year: The Department recommends the GSP clarify the GDE identification methodology and explain if areas identified as GDEs in each of 2013, 2015, and 2017 are retained for further analysis, or if only areas identified in all three years are considered GDEs for the remainder of the GSP.</p>
3	Kevin Thomas	California Department of Fish and Wildlife, North Central Region	15	11/8/2021	5-173	5.2.8	Public Draft GSP	<p>Comment #2 – Groundwater Dependent Ecosystems (5.2.8 Groundwater Dependent Ecosystems; starting page 5-173): Groundwater dependent ecosystem (GDE) identification, required by 23 CCR § 354.16(g), is based on methods that risk exclusion of ecosystems that may depend on groundwater.</p> <p>a. Issues: iv. Special Status Species: Though the GSP includes a list of freshwater species within the Sutter Subbasin, the GSP does not assess the species’ potential groundwater dependence or their spatial extent within the subbasin.</p> <p>b. Recommendations: iv. Special Status Species: The Department recommends the GSP include an assessment of each identified species’ likely groundwater dependence. The GSP should also include a spatial assessment of special status species within the subbasin to characterize which surface waters or GDE areas provide these species habitat or forage; this level of GDE-species-relationship assessment enables GSAs to prioritize GDE monitoring and management decisions.</p>
3	Kevin Thomas	California Department of Fish and Wildlife, North Central Region	16	11/8/2021	6-36	6.5.6	Public Draft GSP	<p>Comment #3 – Sustainable Management Criteria (6.5.6 Depletions of Interconnected Surface Water; starting page 6-36): Interconnected surface water sustainable management criteria (SMC) may not protect against undesirable results for fish and wildlife beneficial uses and users.</p> <p>a. Issues: i. Minimum Thresholds: Minimum thresholds (MTs) for ISW, using groundwater levels as a proxy, are set either at the historic low over the period of record, at 90% of the average groundwater elevation with a modeled increase in evapotranspiration of 50%, or at a level necessary to provide a sufficient operating range below the measurable objective. The GSP’s methodology assumes that undesirable results were not occurring at the historic low; however, the GSP does not include sufficient analysis or discussion to support this claim. In 2015, the second of back-to-back critically dry water years in the Sacramento Valley which resulted in historical low groundwater levels, vegetated and aquatic GDEs experienced adverse impacts including stressed or dying riparian vegetation, poor instream habitat availability, and increased water temperatures (DFW 2019). It is unclear what, if any, studies or analyses were completed to assess whether environmental users within the subbasin experienced undesirable results at the historical low groundwater levels. The GSP assumes that undesirable results for ISW occur only when gaining streams become losing streams. This assumption ignores the benefits of groundwater contributions to surface water baseflows, including the maintenance of instream water quality and temperatures. Reducing the volume of groundwater contributions to ISW, even if a reach has not yet changed from gaining to losing or disconnected, would likely result in significant and unreasonable impacts to fish and wildlife beneficial users of ISW prior to exceedance of the MT. As the GSP neither characterizes specific instream flow or habitat requirements for aquatic species, nor provides baseline information on the volume and timing of ISW depletion (See Comment #1), nor discusses the anticipated rates of depletion that would occur at the established MTs; there is insufficient information to assess potential impacts to ISW beneficial uses and users. The ISW SMC are also regarded in the GSP as protective of GDE beneficial users of groundwater, but the GSP does not provide evidence to support this claim. No analysis is presented that characterizes whether the established MTs are sufficient to maintain water groundwater levels that have historically been shallow enough to support GDEs, or if the MTs would permit groundwater levels to fall below root zones, removing groundwater as an available water source to some GDEs. If MTs are not protective of GDE access to groundwater supplies, significant impacts to environmental beneficial users of groundwater will likely be experienced before MTs are reached.</p> <p>b. Recommendations: i. Minimum Thresholds: The Department recommends the GSP reselect minimum thresholds that would better protect environmental uses and users of groundwater, rather than enabling declines in groundwater levels over the implementation horizon beyond the historic low. Additional analyses of the specific impacts of the established thresholds on monthly groundwater contribution to baseflow in gaining streams, monthly depletion of losing streams, and on GDE and ISW beneficial users of groundwater should be included.</p>
3	Kevin Thomas	California Department of Fish and Wildlife, North Central Region	17	11/8/2021	6-36	6.5.6	Public Draft GSP	<p>Comment #3 – Sustainable Management Criteria (6.5.6 Depletions of Interconnected Surface Water; starting page 6-36): Interconnected surface water sustainable management criteria (SMC) may not protect against undesirable results for fish and wildlife beneficial uses and users.</p> <p>a. Issues: ii. Undesirable Results: The GSP requires 25% of ISW representative monitoring wells in the subbasin to fall below their MTs for two consecutive seasonal high water level measurements before identifying an undesirable result to GDEs or ISW. While environmental users are usually adapted to sustain short-term lowering of groundwater levels during dry periods, environmental users may not be able to sustain extended periods of reduced groundwater access that would result from allowing groundwater levels to fall to historic lows or deeper for two consecutive years. Under these MTs, by the time an undesirable result is declared and management actions are triggered in response to the undesirable result, environmental groundwater users will have already experienced significant stress and potentially irreversible mortality.</p> <p>b. Recommendations: ii. Undesirable Results: The Department recommends the GSP reconsider the two seasonal-high measurements of groundwater levels below MTs required to constitute an undesirable result, recognizing that extended durations of groundwater inaccessibility for environmental users will likely lead to adverse impacts that cannot be easily reversed when groundwater levels recover. At a minimum, the Department recommends identifying physical triggers (e.g., declining Normalized Difference Vegetation Index signals) and associated management actions (e.g., demand reduction) to enable the GSAs to identify and mitigate localized patterns of lowering groundwater or depleted ISW and associated negative impacts before the second year of MT exceedances yields more significant and undesirable impacts. These interim action triggers will help preempt irreversible losses and undesirable results for environmental users.</p>
3	Kevin Thomas	California Department of Fish and Wildlife, North Central Region	18	11/8/2021	6-36	6.5.6	Public Draft GSP	<p>Comment #3 – Sustainable Management Criteria (6.5.6 Depletions of Interconnected Surface Water; starting page 6-36): Interconnected surface water sustainable management criteria (SMC) may not protect against undesirable results for fish and wildlife beneficial uses and users.</p> <p>a. Issues: iii. Environmental Beneficial Users: Though the GSP does discuss the potential impacts of exceeding the established SMC for each sustainability indicator on environmental beneficial uses and users within the subbasin, the GSP does not present sufficient evidence that the MTs will protect against these impacts. For instance, the GSP states that if groundwater level or ISW MTs are exceeded, GDEs could lose access to groundwater and aquatic ecosystems could experience a reduction in suitable habitat through lowered stream depths, flow velocities, and dissolved oxygen; and increased temperatures (pages 6-46). However, in establishing the MTs, the GSP seemingly does not compare the groundwater level or ISW thresholds to GDE rooting depths, nor does the GSP relate the MTs to rates of depletion of surface waters and the associated impacts on instream flows, water temperatures, or the availability of suitable habitat for aquatic species.</p> <p>b. Recommendations: iii. Environmental Beneficial Users: The Department recommends the GSP include specific analysis demonstrating that the established SMCs are sufficiently protective of environmental users of groundwater, including GDEs and ISW. Groundwater level and ISW MTs at each representative monitoring well (See Comment #5) should be compared to the rooting depths of the identified vegetation in nearby GDEs. The GSP should quantify the volume and timing of depletions of ISW that would occur at the established MTs and explicitly discuss the impacts of the projected depletions on aquatic species’ streamflow, water temperature, and habitat needs.</p>
3	Kevin Thomas	California Department of Fish and Wildlife, North Central Region	19	11/8/2021			Public Draft GSP	<p>Comment #4 – Projects and Management Actions (PMAs)(7.1.3 Summary of Projects and Management Actions; starting page 7-3): The GSP should include additional potential PMAs related to the implementation of demand management within the subbasin.</p> <p>a. Issue: The planned and ongoing PMAs within the subbasin focus largely on modernizing water systems operations or implementing recharge projects that may be costly, rely on securing additional surface water supplies, and/or require potentially lengthy permitting processes. Though the GSP indicates that in the projected future conditions scenario, the Sutter Subbasin is expected to maintain groundwater sustainability, should projects fail to produce the anticipated groundwater benefit or localized undesirable results occur, it may be necessary to implement additional demand management projects.</p> <p>b. Recommendation: The Department recommends identifying additional demand management projects as potential PMAs that could be implemented within the subbasin. The Department supports a balanced approach of projects related to both supply augmentation and demand management for managing the subbasin sustainably</p>
3	Kevin Thomas	California Department of Fish and Wildlife, North Central Region	20	11/8/2021			Public Draft GSP	<p>Comment #5 – Monitoring Networks (7.1.4.6 Installation of Additional Shallow Groundwater Monitoring Wells, 7.2.6.1 Groundwater Level Monitoring Network, 7.2.6.6 Interconnected Surface Water Monitoring Network; starting pages 7-56, 7-114, and 7-148): The GSP should include an assessment of the adequacy of the monitoring networks for assessing impacts to GDEs. The GSP should include additional information related to the planned project to improve the monitoring network for GDEs and ISW within the subbasin.</p> <p>a. Issue: The GSP does not include a discussion of the adequacy of the monitoring network for assessing potential impacts to GDEs throughout the subbasin. It is unclear whether any of the identified representative monitoring sites for groundwater levels or ISW are located sufficiently near to GDEs to monitor shallow groundwater levels in those areas. While the Department acknowledges the planned installation of 15 additional shallow wells to improve monitoring of ISW and GDEs, the discussion of the locations of these additional wells focuses on filling data gaps related to ISW and does not discuss planned well locations relative to GDEs within the subbasin.</p> <p>b. Recommendation: The GSP should include additional detail related to adequacy of the existing representative monitoring networks for assessing shallow groundwater conditions and potential impacts to GDEs. The Department recommends that the GSP assess the locations of special status species within the subbasin to determine which GDE areas likely provide priority habitat. GDE areas and ISW that support special status species or are most at risk of negative impacts due to groundwater pumping should be prioritized for monitoring to inform management actions (See Comment #2(iv)).</p>
4	Samantha Arthur	Audubon CA	21	11/11/2021		Figure 2-4	Public Draft GSP	<p>Identification of managed wetlands: Audubon appreciates that the Sutter GSAs have identified and specifically included federal, state and privately managed wetlands in text, figures (e.g. Figure 2-4), and water budgets, especially Sutter National Wildlife Refuge (NWR) and the Butte Sink Wildlife Management Area (WMA).</p>
4	Samantha Arthur	Audubon CA	22	11/11/2021		Table 5-11 and 5-12	Public Draft GSP	<p>Water budget: Audubon appreciates the specific inclusion of managed wetlands into the water budgets (e.g. Table 5-11 and Table 5-12), especially the inclusion of greater water use in the future budget resulting from anticipated delivery of Central Valley Project Improvement Act (CVPIA) Full Level 4 refuge water supplies to Sutter NWR.</p>
4	Samantha Arthur	Audubon CA	23	11/11/2021		Table 7-2	Public Draft GSP	<p>Consideration of managed wetlands: Audubon appreciates that the listed projects included in Table 7-2 (GSP page 7-7) identified opportunities for multi-benefit projects that provide water supply and wildlife habitat benefits and sufficient project details were included in Section 7.1.4.4 (GSP page 7-44).</p>

Sutter Subbasin GSP Public Draft
Tracking of Comments Received as of November 15, 2021

Letter No.	Commenter	Commenter Organization	Comment No.	Date Received	Page	Section, Figure, or Table	Document	Comment
4	Samantha Arthur	Audubon CA	24	11/11/2021			Public Draft GSP	Section 2.2, page 2-21: Suggest modifying the opening sentence in the second paragraph as follows: "Surface water from the Feather and Sacramento Rivers and groundwater are the water sources used for irrigation, managed wetland, municipal and industrial, and urban/domestic purposes (Figure 2-13)"
4	Samantha Arthur	Audubon CA	25	11/11/2021			Public Draft GSP	Table 2-2, page 2-21: Suggest adding "including managed wetlands" as a parenthetical descriptor to "Riparian Vegetation" as often the former category includes explicit actions to apply water and manage food and habitat compared to riparian vegetation which often correlates to unmanaged stream course vegetation and habitats depending on a riparian water source.
4	Samantha Arthur	Audubon CA	26	11/11/2021			Public Draft GSP	Figure 2-12, page 2-22: Same comment as described for Table 2-2.
4	Samantha Arthur	Audubon CA	27	11/11/2021			Public Draft GSP	Figure 2-13, page 2-23: Suggest shading the Sutter NWR and Butte Sink WMA areas and including in the legend as "irrigated managed wetlands" to help demonstrate these lands actively apply water within these boundaries.
4	Samantha Arthur	Audubon CA	28	11/11/2021			Public Draft GSP	Section 2.2.2, page 2-53: Suggest adding a subsection for "managed wetlands water supply" similar to the subsection for "urban water supply" and "agricultural water supply." Because these land uses apply both surface and groundwater, with the Sutter NWR receiving supplies under congressional mandate (CVPIA refuge water supply program), it is important for the reader to see this user in similar context to agricultural and urban uses.
4	Samantha Arthur	Audubon CA	29	11/11/2021			Public Draft GSP	Table 5-10, page 5-189: This table should include a row for "managed wetlands demand" (similar to "agricultural demand" and "urban demand") to help provide the basis for higher future water demands and surface supplies as infrastructure to adequately delivery CVPIA mandated water supplies to Sutter NWR is anticipated to be completed and CVPIA Full Level 4 water supplies to Sutter NWR are slated to begin more routinely.
4	Samantha Arthur	Audubon CA	30	11/11/2021			Public Draft GSP	Footnote 1, page 5-193: Please correct the spelling to read "Greg Young"
4	Samantha Arthur	Audubon CA	31	11/11/2021			Public Draft GSP	Section 5.3.5, page 5-194: Suggest adding "managed wetlands" for the surface water and groundwater bullets under "Inflow.
5	Ben King	Member of the Public, Colusa Resident	32	11/11/2021		Figure 2-7	Public Draft GSP	The community of Meridian should be included. It is a longstanding community of north western Sutter County and includes an elementary school dependent on groundwater for water supply.
5	Ben King	Member of the Public, Colusa Resident	33	11/11/2021		2.1.3.2.3	Public Draft GSP	Water Transfers out of the basin and the mechanics of groundwater substitution should be discussed and reference the data in Section 2.4. One of the 5 public comments in the draft Appendix expressed concern about groundwater transfers. There is currently litigation with settlement contractor plaintiffs concerning out of basin water transfers and groundwater substitution.
5	Ben King	Member of the Public, Colusa Resident	34	11/11/2021		2.3.1.12	Public Draft GSP	There should be discussion regarding the prioritization of subbasins in the implementation of CV Salts and how the Sutter Subbasin is not designated as a priority subbasin.
5	Ben King	Member of the Public, Colusa Resident	35	11/11/2021		2.4	Public Draft GSP	Is it correct that substitution transfers are completed by agencies not using their full allotment of water? Is it not just use of groundwater in lieu for the water transferred out of the basin – the impact is that the Sutter Subbasin water budget allocated amount available is reduced by the amount of water transferred?
5	Ben King	Member of the Public, Colusa Resident	36	11/11/2021		2.5.10	Public Draft GSP	If groundwater is pumped in the sphere of hydrological impact of groundwater substitutions isn't it clear that there could be a negative impact on a GDW if water levels are lowered in a materially adverse way or if groundwater is degraded. There definitely are known concerns even though the impacts have not been studied. This needs to be addressed here or in Section 5.3
5	Ben King	Member of the Public, Colusa Resident	37	11/11/2021		3.2.5, 3.2.6, 3.2.7	Public Draft GSP	There are no websites included? How can Stakeholders know of public meetings or gain access to public information for these GSA's?
5	Ben King	Member of the Public, Colusa Resident	38	11/11/2021		4.1.1	Public Draft GSP	It should be noted that the HRTW was incorporated into the DWR Department Manual during April 2021 as noted in the recent DWR Drought Resolution. The pending SWRB resolution on Racial Equity should also be noted as a basis for the consideration of adverse racial outcomes due the implementation of the GSP for the Sutter Subbasin. The Sutter Subbasin is especially significant for Diversity, Equity, and Inclusion issues because it has significant populations from the Mexican American, African American and Sikh communities.
5	Ben King	Member of the Public, Colusa Resident	39	11/11/2021		4.1	Public Draft GSP	Generally – there should be some discussion regarding outreach to the Spanish speaking and Punjabi speaking communities. The notices and communications in three different languages for the Sutter Subbasin should be highlighted.
5	Ben King	Member of the Public, Colusa Resident	40	11/11/2021		4.2.2	Public Draft GSP	There were only 5 public comments included in the Appendix. As a Stakeholder, there was no public disclosure of public comments made during meetings or any comments received except for the five responses to an early survey. This was a definite failure for Stakeholder Engagement since the public has no idea what other comments were submitted or expressed by other stakeholders during the GSP development. Many of the comments that I submitted were unacknowledged and I have no idea if any of the comments were considered in the draft GSP development. I also submitted a PMA which was also unacknowledged with no evidence that it was considered in the PMAs set forth in the Appendix. There are no publicly submitted PMAs in the Appendix and most of the PMAs set forth in the Appendix have no source submissions or backup information. The PMAs detailed in the Appendix relate to projects developed in 2014.
6	Ngodoo Atume, Samantha Arthur, E.J. Remson, J. Pablo Ortiz-Partida, Ph.D., Danielle V. Dolan, Melissa M. Rohde, Amy Merrill, Ph.D., Kristan Culbert,	Clean Water Action/Clean Water Fund, Union of Concerned Scientists, Audobon CA, Local Government Comission, TNC, American Rivers	41	11/12/2021			Public Draft GSP	<p>Identification of Key Beneficial Uses and Users: Disadvantaged Communities, Drinking Water Users, and Tribes</p> <p>The identification of Disadvantaged Communities (DACs) and drinking water users is insufficient. The GSP identifies and maps the locations of DACs and describes each DAC population within the subbasin. However, we note the following deficiencies with the identification of these key beneficial users:</p> <ul style="list-style-type: none"> - The GSP identifies tribal communities that may have cultural and traditional ties within the subbasin. However, the plan fails to map the locations of tribal lands or tribal interests in the subbasin. - The GSP provides a map of domestic well density in Figure 2-9, but fails to provide depth of these wells (such as minimum well depth, average well depth, or depth range) within the subbasin. This information is necessary to understand the distribution of shallow and vulnerable drinking water wells within the basin. - While the GSP identifies the population dependent on groundwater as their source of drinking water in the subbasin, specifics are not provided on how much each DAC community relies on a particular water supply (e.g., what percentage is supplied by groundwater). - The GSP references CalEnviroScreen 3.0, but is not updated with the most recent CalEnviroScreen results from 4.0. <p>These missing elements are required for the GSAs to fully understand the specific interests and water demands of these beneficial users, and to support the consideration of beneficial users in the development of sustainable management criteria and selection of projects and management actions.</p> <p>Recommendations:</p> <ul style="list-style-type: none"> - Provide a map of tribal lands and describe tribal interests in the subbasin - Include a map showing domestic well locations and average well depth across the subbasin. - Identify the sources of drinking water for DAC members, including an estimate of how many people rely on groundwater (e.g., domestic wells, state small water systems, and public water systems). - Utilize the updated version 4.0 of CalEnviroScreen. <p>*1 Our letter provides a review of the identification and consideration of federally recognized tribes (Data source: SGMA Data viewer) within the GSP from non-tribal members and NGOs. Based on the likely incomplete information available to our organizations for this review, we recommend that the GSA utilize the California Department of Water Resources' "Engagement with Tribal Governments" Guidance Document (https://water.ca.gov/Programs/Groundwater-Management/SGMA-Groundwater-Management/Best-Management-Practices-and-Guidance-Documents) to comprehensively address these important beneficial users in their GSP.</p>
6	Ngodoo Atume, Samantha Arthur, E.J. Remson, J. Pablo Ortiz-Partida, Ph.D., Danielle V. Dolan, Melissa M. Rohde, Amy Merrill, Ph.D., Kristan Culbert,	Clean Water Action/Clean Water Fund, Union of Concerned Scientists, Audobon CA, Local Government Comission, TNC, American Rivers	42	11/12/2021			Public Draft GSP	<p>Identification of Key Beneficial Uses and Users: Interconnected Surface Waters</p> <p>The identification of Interconnected Surface Waters (ISWs) is incomplete. Streamflow depletion in the Sutter Subbasin was evaluated using the C2VSimFG-Sutter model, an integrated hydrologic flow model for the subbasin. The model is described in Appendix 5-G (C2VSimFG-Sutter Model Report) and simulates the period from 1996 to 2015. Appendix 5-G describes the data used in the model, including the location and screening depths of groundwater wells and stream gauge data in the subbasin.</p> <p>The GSP confirms the results of the ISW analysis with data from TNC's Interconnected Surface Water in the Central Valley (ICONS) website, as presented on Figure 5-92 of the GSP.2</p> <p>Stream nodes from the model were characterized as having gaining conditions, losing conditions, or mixed conditions (Figure 5-91). The GSP states: "The C2VSimFG-Sutter model does not contain stream nodes in the Sutter Buttes foothills, and therefore the interaction between those streams and the underlying water table were not evaluated." We recommend that these stream reaches are retained as potential ISWs in the GSP until further data is gathered.</p> <p>Recommendations:</p> <ul style="list-style-type: none"> - To confirm the results of the groundwater modeling analysis and support conclusions about the Sutter Buttes foothills stream reaches, overlay the stream reaches shown with depth-to-groundwater contour maps to illustrate groundwater depths and the groundwater gradient near the stream reaches. For the depth-to-groundwater contour maps, use the best practices presented in Attachment D. Specifically, ensure that the first step is contouring groundwater elevations, and then subtracting this layer from land surface elevations from a Digital Elevation Model (DEM) to estimate depth-to-groundwater contours across the landscape. This will provide accurate contours of depth to groundwater along streams and other land surface depressions where GDEs are commonly found. - Describe data gaps for the ISW analysis in the ISW section, in addition to the discussion in Section 7.2.6.6.5 (Interconnected Surface Water Monitoring Network Data Gaps). While the GSP identifies data gaps and their locations in the text, we recommend that the GSP considers any segments with data gaps as potential ISWs and clearly marks them as such on maps provided in the GSP. <p>*2Available online at: https://icons.codefornature.org/</p>

Sutter Subbasin GSP Public Draft
Tracking of Comments Received as of November 15, 2021

Letter No.	Commenter	Commenter Organization	Comment No.	Date Received	Page	Section, Figure, or Table	Document	Comment
6	Ngodoo Atume, Samantha Arthur, E.J. Remson, J. Pablo Ortiz-Partida, Ph.D., Danielle V. Dolan, Melissa M. Rohde, Amy Merrill, Ph.D., Kristan Culbert,	Clean Water Action/Clean Water Fund, Union of Concerned Scientists, Audobon CA, Local Government Comission, TNC, American Rivers	43	11/12/2021			Public Draft GSP	<p>Identification of Key Beneficial Uses and Users: Groundwater Dependent Ecosystems</p> <p>The identification of Groundwater Dependent Ecosystems (GDEs) is insufficient. The GSP took initial steps to identify and map GDEs using the Natural Communities Commonly Associated with Groundwater dataset (NC dataset). However, we found that some mapped features in the NC dataset were improperly disregarded. NC dataset polygons were incorrectly removed in areas adjacent to irrigated fields or adjacent to rivers and streams. However, this removal criteria is flawed since GDEs can rely on multiple water sources – including shallow groundwater receiving inputs from surface water flow or irrigation return flow from nearby irrigated fields –simultaneously and at different temporal/spatial scales. NC dataset polygons adjacent to irrigated land or surface water supplies can still potentially be reliant on shallow groundwater aquifers, and therefore should not be removed solely based on their proximity to these additional water sources.</p> <p>The GSP identifies and maps GDEs in normal (2013), dry (2015), and wet (2017) years based on a 30-foot screening threshold; maps are presented in Figures 5-96, 5-97, and 5-98, respectively. However, no description or presentation of groundwater data (such as depth-to-groundwater contour maps) is provided. Furthermore, it is unclear which GDEs are retained as potential GDEs for the purposes of establishing monitoring and sustainable management criteria.</p> <p>The GSP states (5-173): “Oak trees are considered the deepest-rooted plant in the region with a root zone of roughly 25 to 30 feet.” If Valley Oaks exist in the subbasin, we recommend instead that an 80-foot depth-to-groundwater threshold be used when inferring whether Valley Oak polygons in the NC dataset are likely reliant on groundwater. This recommendation is based on a recent correction in TNC’s rooting depth database, after finding a typo in the max rooting depth3 units for Valley Oak. This resulted in a specific change in the max rooting depth of Valley Oak from 24 feet to 24 meters (80 feet). For all other phreatophytes, we continue to recommend that a 30-foot depth-to-groundwater threshold be used when inferring whether all other NC dataset polygons are likely reliant on groundwater.</p> <p>Recommendations: - Re-evaluate the NC dataset polygons that are adjacent to irrigated fields or streams and rivers. Refer to Attachment D of this letter for best practices for using local groundwater data to verify whether polygons in the NC Dataset are supported by groundwater in an aquifer. - Use depth-to-groundwater data from multiple seasons and water year types (e.g., wet, dry, average, drought) to determine the range of depth to groundwater around NC dataset polygons. We recommend that a baseline period (10 years from 2005 to 2015) be established to characterize groundwater conditions over multiple water year types. - Provide depth-to-groundwater contour maps, noting the best practices presented in Attachment D. Specifically, ensure that the first step is contouring groundwater elevations, and then subtracting this layer from land surface elevations from a DEM to estimate depth-to-groundwater contours across the landscape. - Refer to Attachment B for more information on TNC’s plant rooting depth database. Deeper thresholds are necessary for plants that have reported maximum root depths that exceed the averaged 30-ft threshold, such as Valley Oak (Quercus lobata). We recommend that the reported max rooting depth for these deeper-rooted plants be used. For example, a depth-to-groundwater threshold of 80 feet should be used instead of the 30-ft threshold, when verifying whether Valley Oak polygons from the NC Dataset are connected to groundwater. It is important to emphasize that actual rooting depth data are limited and will depend on the plant species and site-specific conditions such as soil and aquifer types, and proximity to other water sources. - If insufficient data are available to describe groundwater conditions within or near polygons from the NC dataset, include those polygons as “Potential GDEs” in the GSP until data gaps are reconciled in the monitoring network.</p> <p>*3 TNC. 2021. Plant Rooting Depth Database. Available at:https://groundwaterresourcehub.org/sgma-tools/gde-rooting-depths-database-for-gdes/</p>
6	Ngodoo Atume, Samantha Arthur, E.J. Remson, J. Pablo Ortiz-Partida, Ph.D., Danielle V. Dolan, Melissa M. Rohde, Amy Merrill, Ph.D., Kristan Culbert,	Clean Water Action/Clean Water Fund, Union of Concerned Scientists, Audobon CA, Local Government Comission, TNC, American Rivers	44	11/12/2021			Public Draft GSP	<p>Identification of Key Beneficial Uses and Users: Native Vegetation and Managed Wetlands</p> <p>Native vegetation and managed wetlands are water use sectors that are required to be included in the water budget. , The integration of these ecosystems into the water budget is sufficient 4,5 because the GSP includes the groundwater demands of native vegetation and managed wetlands as separate line items in the historical, current, and projected water budgets.</p> <p>*4 “Water use sector” refers to categories of water demand based on the general land uses to which the water is applied, including urban, industrial, agricultural, managed wetlands, managed recharge, and native vegetation.” [23 CCR §351(a)] *5 “The water budget shall quantify the following, either through direct measurements or estimates based on data: (3) Outflows from the groundwater system by water use sector, including evapotranspiration, groundwater extraction, groundwater discharge to surface water sources, and subsurface groundwater outflow.” [23 CCR §354.18]</p>
6	Ngodoo Atume, Samantha Arthur, E.J. Remson, J. Pablo Ortiz-Partida, Ph.D., Danielle V. Dolan, Melissa M. Rohde, Amy Merrill, Ph.D., Kristan Culbert,	Clean Water Action/Clean Water Fund, Union of Concerned Scientists, Audobon CA, Local Government Comission, TNC, American Rivers	45	11/12/2021			Public Draft GSP	<p>Engaging Stakeholders: Stakeholder Engagement During GSP Development</p> <p>Stakeholder engagement during GSP development is insufficient. SGMA’s requirement for public notice and engagement of stakeholders is not fully met by the description in the Outreach and Communication chapter of the GSP (Chapter 4).6</p> <p>We note the following deficiencies with the overall stakeholder engagement process: - The GSP documents opportunities for public involvement and engagement in general terms. Public outreach and engagement activities include quarterly public workshops, public meetings, updates at GSA board and city council meetings, updates to the project website, email notices, social media postings, press releases and mailings, utility bill notifications, supporting materials provided in English, Spanish, and Punjabi, and online surveys for stakeholder feedback and input. There are no details of outreach and engagement specifically targeted to DACs, drinking water users, tribes, and environmental stakeholders during the GSP development process. - Aside from the continuation of engagement strategies used during the GSP development process, the GSP does not include a detailed plan for continual opportunities for engagement through the implementation phase of the GSP that is specifically directed to DACs, drinking water users, tribes, and environmental stakeholders.</p> <p>Recommendations: - In the Outreach and Communication chapter, describe active and targeted outreach to engage DACs, drinking water users, tribes, and environmental stakeholders throughout the GSP development and implementation phases. Refer to Attachment B for specific recommendations on how to actively engage stakeholders during all phases of the GSP process. - Utilize DWR’s tribal engagement guidance to comprehensively address all tribes and tribal interests in the subbasin within the GSP.7</p> <p>*6 “A communication section of the Plan shall include a requirement that the GSP identify how it encourages the active involvement of diverse social, cultural, and economic elements of the population within the basin.” [23 CCR §354.10(d)(3)] *7 Engagement with Tribal Governments Guidance Document. Available at: https://water.ca.gov/-/media/DWR-Website/Web-Pages/Programs/Groundwater-Management/Sustainable-Groundwater-Management/Best-Management-Practices-and-Guidance-Documents/Files/Guidance-Doc-for-SGM-Engagement-with-Tribal-Govt_ay_19.pdf</p>

Sutter Subbasin GSP Public Draft
Tracking of Comments Received as of November 15, 2021

Letter No.	Commenter	Commenter Organization	Comment No.	Date Received	Page	Section, Figure, or Table	Document	Comment
6	Ngodoo Atume, Samantha Arthur, E.J. Remson, J. Pablo Ortiz-Partida, Ph.D., Danielle V. Dolan, Melissa M. Rohde, Amy Merrill, Ph.D., Kristan Culbert,	Clean Water Action/Clean Water Fund, Union of Concerned Scientists, Audobon CA, Local Government Comission, TNC, American Rivers	46	11/12/2021			Public Draft GSP	<p>Considering Beneficial Uses and Users When Establishing Sustainable Management Criteria and Analyzing Impacts on Beneficial Uses and Users</p> <p>The consideration of beneficial uses and users when establishing sustainable management criteria (SMC) is insufficient. The consideration of potential impacts on all beneficial users of groundwater in the basin are required when defining undesirable results and establishing minimum thresholds. 8 9 10</p> <p>Disadvantaged Communities and Drinking Water Users</p> <p>For chronic lowering of groundwater levels, the GSP states (p. 6-11): "The minimum threshold for chronic lowering of groundwater levels is established as the deepest of the following: The historic low for the available record at each representative monitoring site; or 2. 90% of the average groundwater elevation from the projected water budget (baseline condition over 60-year period using C2VSimFG-Sutter) at each representative monitoring site with an artificial increase in evapotranspiration (ET) of 50%; or 3. The average operating range (difference between measurable objective and minimum threshold) for all representative monitoring sites using the above criteria for the following aquifer zones (AZs), applied based on the available screen interval or well depth information for each representative monitoring site: a. Shallow AZ and AZ-1 = 8.0 feet b. AZ-2 and AZ-3 = 16.5 feet."</p> <p>The GSP states (6-17): "The average operating range for the Shallow AZ and AZ-1 were combined with the goal of being protective of interconnected surface waters, GDEs, and shallow domestic wells." The text continues (p. 6-17): "A minimum operating range is applied where applicable in order to allow for a reasonable use of groundwater by all beneficial users in the Sutter Subbasin." However, no analysis is presented that describes the impact of minimum thresholds on domestic well users. The GSP does not sufficiently describe whether minimum thresholds will avoid significant and unreasonable loss of drinking water to domestic well users, and whether the undesirable results are consistent with the Human Right to Water policy. In 11 addition, the GSP does not sufficiently describe or analyze direct or indirect impacts on DACs or tribes when defining undesirable results, nor does it describe how the groundwater levels minimum thresholds are consistent with Human Right to Water policy and will avoid significant and unreasonable impacts on these beneficial users.</p> <p>For degraded water quality, SMC are established for total dissolved solids (TDS) and nitrate. The GSP states (p. 6-24): "The minimum threshold for degraded water quality is established as the highest of: (1) the Upper SMCL for TDS (1,000 mg/L) and Primary MCL for nitrate as N (10 mg/L) or (2) current water quality conditions for TDS and nitrate as N based on data available from 2000 to the time of GSP development (Summer 2021) at the representative monitoring well or nearby well within the same aquifer zone, as described in Section 5.2.5 of the Basin Setting chapter, using maximum concentration detected of each constituent." However, according to the state's anti-degradation policy, high water quality should be protected and is only allowed to worsen if a 12 finding is made that it is in the best interest of the people of the State of California. No analysis has been done and no such finding has been made.</p> <p>Section 5.1.9 of the GSP (Water Quality) discusses water quality trends for several other constituents, including arsenic, boron, iron, manganese, and point-source contaminants. No SMC have been established for these additional constituents, however. SMC should be established for all COCs in the subbasin impacted or exacerbated by groundwater use and/or management, in addition to coordinating with water quality regulatory programs.</p> <p>The GSP only includes a very general discussion of impacts on drinking water users when defining undesirable results and evaluating the impacts of proposed minimum thresholds. The GSP does not, however, mention or discuss direct and indirect impacts on DACs or tribes when defining undesirable results for degraded water quality, nor does it evaluate the cumulative or indirect impacts of proposed minimum thresholds on these beneficial users.</p> <p>Recommendations:</p> <p>Chronic Lowering of Groundwater Levels</p> <ul style="list-style-type: none"> - Describe direct and indirect impacts on drinking water users, DACs, and tribes when describing undesirable results and defining minimum thresholds for chronic lowering of groundwater levels. - Consider and evaluate the impacts of selected minimum thresholds and measurable objectives on drinking water users, DACs, and tribes within the subbasin. Further describe the impact of passing the minimum threshold for these users. For example, provide the number of domestic wells that would be fully or partially de-watered at the minimum threshold. <p>Degraded Water Quality</p> <ul style="list-style-type: none"> - Describe direct and indirect impacts on drinking water users, DACs, and tribes when defining undesirable results for degraded water quality. For specific guidance on how 13 to consider these users, refer to "Guide to Protecting Water Quality Under the Sustainable Groundwater Management Act."14 - Evaluate the cumulative or indirect impacts of proposed minimum thresholds for degraded water quality on drinking water users, DACs, and tribes. - For TDS and nitrate, provide a summary table that presents the pre-2015 historical maximums, the objectives from the Basin Plan, the MCLs, and the resulting minimum thresholds. Ensure that the minimum thresholds do not exceed the objectives in the Basin Plan. - Set minimum thresholds and measurable objectives for all water quality constituents within the subbasin that can be impacted and/or exacerbated as a result of groundwater use or groundwater management. - Set minimum thresholds that do not allow water quality to degrade to levels at or above the MCL trigger level. <p>*8 "The description of undesirable results shall include [...] potential effects on the beneficial uses and users of groundwater, on land uses and property interests, and other potential effects that may occur or are occurring from undesirable results." [23 CCR §354.26(b)(3)]</p>
6	Ngodoo Atume, Samantha Arthur, E.J. Remson, J. Pablo Ortiz-Partida, Ph.D., Danielle V. Dolan, Melissa M. Rohde, Amy Merrill, Ph.D., Kristan Culbert,	Clean Water Action/Clean Water Fund, Union of Concerned Scientists, Audobon CA, Local Government Comission, TNC, American Rivers	47	11/12/2021			Public Draft GSP	<p>Groundwater Dependent Ecosystems and Interconnected Surface Waters</p> <p>For chronic lowering of groundwater levels, minimum thresholds are established in the same manner as stated above under Disadvantaged Communities and Drinking Water Users (i.e., established as the deeper of three values). The result is that minimum thresholds allow groundwater levels to drop to, or below, historic lows in the subbasin. To describe effects on environmental beneficial uses and users, the GSP states (p. 6-22): "Environmental users of groundwater typically rely on shallow groundwater (within 50 feet of ground surface or less) for recharge to interconnected streams and access by GDEs. If minimum thresholds for chronic lowering of groundwater levels are exceeded (even if an undesirable result is not observed), reduced groundwater recharge to streams and groundwater levels too deep for GDE species to access may be observed." The true impacts to ecosystems under this scenario are not fully discussed in the GSP. By assuming that GDEs can be sustained on historic low groundwater levels (or lower) and the subbasin is allowed to operate at or close to those levels over many years, there is a risk of causing catastrophic damage to ecosystems that is more adverse than what was occurring at the height of the 2012-2016 drought. While many California ecosystems are drought-adapted and therefore able to accommodate short-term water stress, prolonged drought conditions could cause adverse impacts, such as widespread tree mortality or loss of critical habitat for aquatic species, that are more severe than pre-2015 drought impacts.</p> <p>For depletion of interconnected surface water, groundwater elevations are used as proxy for establishing SMC. As for chronic lowering of groundwater levels, minimum thresholds are again established in the same manner as stated above under Disadvantaged Communities and Drinking Water Users (i.e., established as the deeper of three values). To describe effects on environmental beneficial uses and users, the GSP states (p. 6-46): "If an undesirable result for depletions of interconnected surface water is observed and presently gaining streams become losing streams, this reversal of stream interconnection would affect aquatic systems and potentially GDEs. Overall water supply utilized by environmental beneficial users of water would be reduced, thereby reducing suitable habitat through reduced stream depth, flow velocity, cover, and dissolved oxygen as well as increased temperature." However, no analysis or discussion is presented to describe how the SMC will affect beneficial users, and more specifically GDEs, or the impact of these minimum thresholds on GDEs in the subbasin. Furthermore, the GSP makes no attempt to evaluate how the proposed minimum thresholds and measurable objectives avoid significant and unreasonable effects on surface water beneficial users in the subbasin (see Attachment C for a list of environmental users in the subbasin), such as increased mortality and inability to perform key life processes (e.g., reproduction, migration).</p> <p>Recommendations:</p> <ul style="list-style-type: none"> - When defining undesirable results for chronic lowering of groundwater levels, provide specifics on what biological responses (e.g., extent of habitat, growth, recruitment rates) would best characterize a significant and unreasonable impact to GDEs. Undesirable results to environmental users occur when 'significant and unreasonable' effects on beneficial users are caused by one of the sustainability indicators (i.e., chronic lowering of groundwater levels, degraded water quality, or depletion of interconnected surface water). Thus, potential impacts on environmental beneficial uses and users need to be considered when defining undesirable results in the subbasin. Defining undesirable results is the crucial first step before the minimum 15 thresholds can be determined.16 - When defining undesirable results for depletion of interconnected surface water, include a description of potential impacts on instream habitats within ISWs when minimum thresholds in the subbasin are reached. The GSP should confirm that 17 minimum thresholds for ISWs avoid adverse impacts to environmental beneficial users of interconnected surface waters as these environmental users could be left unprotected by the GSP. These recommendations apply especially to environmental beneficial users that are already protected under pre-existing state or federal law.6,18 - When establishing SMC for the subbasin, consider that the SGMA statute [Water Code §10727.4(i)] specifically calls out that GSPs shall include "impacts on groundwater dependent ecosystems". <p>*15 "The description of undesirable results shall include [...] potential effects on the beneficial uses and users of groundwater, on land uses and property interests, and other potential effects that may occur or are occurring from undesirable results". [23 CCR §354.26(b)(3)]</p> <p>*16 The description of minimum thresholds shall include [...] how minimum thresholds may affect the interests of beneficial uses and users of groundwater or land uses and property interests." [23 CCR §354.28(b)(4)]</p> <p>*17 "The minimum threshold for depletions of interconnected surface water shall be the rate or volume of surface water depletions caused by groundwater use that has adverse impacts on beneficial uses of the surface water and may lead to undesirable results." [23 CCR §354.28(c)(6)]</p> <p>*18 Rohde MM, Seapy B, Rogers R, Castañeda X, editors. 2019. Critical Species LookBook: A compendium of California's threatened and endangered species for sustainable groundwater management. The Nature Conservancy, San Francisco, California. Available at: https://groundwaterresourcehub.org/public/uploads/pdfs/Critical_Species_LookBook_91819.pdf</p>
6	Ngodoo Atume, Samantha Arthur, E.J. Remson, J. Pablo Ortiz-Partida, Ph.D., Danielle V. Dolan, Melissa M. Rohde, Amy Merrill, Ph.D., Kristan Culbert,	Clean Water Action/Clean Water Fund, Union of Concerned Scientists, Audobon CA, Local Government Comission, TNC, American Rivers	48	11/12/2021			Public Draft GSP	<p>2. Climate Change</p> <p>The SGMA statute identifies climate change as a significant threat to groundwater resources and one that must be examined and incorporated in the GSPs. The GSP Regulations require integration of climate change into the projected water budget to ensure that projects and management actions sufficiently account for the range of potential climate futures. The effects of climate change will intensify the impacts 19 of water stress on GDEs, making available shallow groundwater resources especially critical to their survival. Condon et al. (2020) shows that GDEs are more likely to succumb to water stress and rely more on groundwater during times of drought. When shallow groundwater is unavailable, riparian forests can 20 die off and key life processes (e.g., migration and spawning) for aquatic organisms, such as steelhead, can be impeded.</p> <p>The integration of climate change into the projected water budget is insufficient. The GSP incorporates climate change into the projected water budget using DWR change factors for 2070. The plan reports some calculations in the Appendix for an Extremely Dry scenario to stress the system but does not seem to report and compare such results outside the Appendix. The GSP would benefit from clearly and transparently incorporating the extremely wet and dry scenarios provided by DWR into projected water budgets or select more appropriate extreme scenarios for the subbasin. While these extreme scenarios may have a lower likelihood of occurring, their consequences could be significant and their inclusion can help identify important vulnerabilities in the subbasin's approach to groundwater management.</p> <p>The GSP integrates climate change into key inputs (e.g., changes in precipitation and evapotranspiration) of the projected water budget. However, imported water should also be adjusted for climate change and incorporated into the surface water flow inputs of the projected water budget. The sustainable yield is calculated based on the projected water budget with climate change incorporated. However, if the water budgets are incomplete, including the omission of extreme climate scenarios and the omission of projected climate change effects on imported water inputs, then there is increased uncertainty in virtually every subsequent calculation used to plan for projects, derive measurable objectives, and set minimum thresholds. Plans that do not adequately include climate change projections may underestimate future impacts on vulnerable beneficial users of groundwater such as ecosystems, DACs, tribes, and domestic well owners.</p> <p>Recommendations:</p> <ul style="list-style-type: none"> - Integrate climate change, including extreme climate scenarios, into all elements of the projected water budget to form the basis for development of sustainable management criteria and projects and management actions. - Incorporate climate change into surface water flow inputs, including imported water, for the projected water budget. - Incorporate climate change scenarios into projects and management actions. <p>*19 "Each Plan shall rely on the best available information and best available science to quantify the water budget for the basin in order to provide an understanding of historical and projected hydrology, water demand, water supply, land use, population, climate change, sea level rise, groundwater and surface water interaction, and subsurface groundwater flow." [23 CCR §354.18(e)]</p> <p>*20 Condon et al. 2020. Evapotranspiration depletes groundwater under warming over the contiguous United States. Nature Communications. Available at: https://www.nature.com/articles/s41467-020-14688-0</p>

Sutter Subbasin GSP Public Draft
Tracking of Comments Received as of November 15, 2021

Letter No.	Commenter	Commenter Organization	Comment No.	Date Received	Page	Section, Figure, or Table	Document	Comment
6	Ngodoo Atume, Samantha Arthur, E.J. Remson, J. Pablo Ortiz-Partida, Ph.D., Danielle V. Dolan, Melissa M. Rohde, Amy Merrill, Ph.D., Kristan Culbert,	Clean Water Action/Clean Water Fund, Union of Concerned Scientists, Audobon CA, Local Government Comission, TNC, American Rivers	49	11/12/2021			Public Draft GSP	Data Gaps <p>The consideration of beneficial users when establishing monitoring networks is insufficient, due to lack of specific plans to increase the Representative Monitoring Wells (RMWs) in the monitoring network that represent water quality conditions and shallow groundwater elevations around DACs and domestic wells in the subbasin. These beneficial users may remain unprotected by the GSP without adequate monitoring and identification of data gaps in the shallow aquifer. The Plan therefore fails to meet SGMA's requirements for the monitoring network.21</p> <p>Figure 7-2 (Groundwater Level Monitoring Network Wells, Shallow AZ) shows insufficient representation of DACs and drinking water users for shallow groundwater elevation monitoring. Figure 7-7 (Groundwater Quality Monitoring Network Wells, Shallow AZ) shows insufficient representation of DACs and drinking water users for shallow water quality monitoring. Refer to Attachment E for maps of these monitoring sites in relation to key beneficial users of groundwater.</p> <p>Recommendations: - Provide maps that overlay current and proposed monitoring well locations with the locations of DACs, domestic wells, and GDEs to clearly identify monitored areas. - Increase the number of RMWs in the shallow aquifer across the subbasin as needed to map ISWs and adequately monitor all groundwater condition indicators across the subbasin and at appropriate depths for all beneficial users. Prioritize proximity to DACs, domestic wells, GDEs, and ISWs when identifying new RMWs. - Ensure groundwater elevation and water quality RMWs are monitoring groundwater conditions spatially and at the correct depth for all beneficial users - especially DACs, domestic wells, and GDEs. - Provide further details for the biological monitoring (described in the Projects and Management Actions section of the GSP) that can be used to assess the potential for significant and unreasonable impacts to GDEs or ISWs due to groundwater conditions in the subbasin.</p> <p>*21 "The monitoring network objectives shall be implemented to accomplish the following: [...] (2) Monitor impacts to the beneficial uses or users of groundwater." [23 CCR §354.34(b)(2)]</p>
6	Ngodoo Atume, Samantha Arthur, E.J. Remson, J. Pablo Ortiz-Partida, Ph.D., Danielle V. Dolan, Melissa M. Rohde, Amy Merrill, Ph.D., Kristan Culbert,	Clean Water Action/Clean Water Fund, Union of Concerned Scientists, Audobon CA, Local Government Comission, TNC, American Rivers	50	11/12/2021			Public Draft GSP	Addressing Beneficial Users in Projects and Management Actions <p>The consideration of beneficial users when developing projects and management actions is sufficient due to the plan's clear identification of the benefits and impacts of projects and management actions, including water quality impacts, to key beneficial users of groundwater such as GDEs and DACs.</p> <p>We commend the GSAs for describing the environmental benefits of the on-farm groundwater recharge program in the Sutter Subbasin, as developed with support and guidelines from The Nature Conservancy (TNC). The program is based on the TNC's multi-benefit recharge program.</p> <p>Because the GSP fails to clearly analyze impacts to domestic wells and DACs due to chronic lowering of groundwater levels, we recommend inclusion of a drinking water well impact mitigation program to proactively monitor and protect drinking water wells through GSP implementation.</p> <p>Recommendations: - For DACs and domestic well owners, include a drinking water well impact mitigation program to proactively monitor and protect drinking water wells through GSP implementation. Refer to Attachment B for specific recommendations on how to implement a drinking water well mitigation program. - Develop management actions that incorporate climate and water delivery uncertainties to address future water demand and prevent future undesirable results.</p>
7	Ben King	Member of the Public, Colusa Resident	51	11/12/2021		5.1	Public Draft GSP	The should be a short discussion about the missile silos constructed on the northern side of the Sutter Buttes as part of the 851st Strategic Missile Squadron – Site 851-B since the structural changes for the missile silo(s) may have some impact on the groundwater quality for the adjacent GDE and its proximity to Grey Lodge. It may be nothing but since the geology of the ancient volcanic structure and related fault/dome structures there may be a possibility of upwelling of saline water and/or the translocation of naturally occurring contaminants consistent with the geology and hydrochemistry of that particular area. See "Cold War relics: Deactivated Titan 1 missile silos surround Beale" by Senior Airman Allen Pollard, 9th Reconnaissance Wing Public Affairs/Published June 07, 2013.
7	Ben King	Member of the Public, Colusa Resident	52	11/12/2021		5.1.3	Public Draft GSP	The Bottom of the Sutter Subbasin can not be best approximated by using Berkstresser, 1973. The Colusa and Yolo GSPs are using Olmstead and Davis, 1961 which has a more appropriate EC level of 2000 rather than 3000. It was not totally clear to me if the Butte Subbasin GSP was using a modified approach to Olmstead and Davis because there was a reference to a DWR source but it is clear that the adjacent GSPs have not incorporated any updated fresh water contours that the DWR has considered as part of the work done by Springhorn et. al. as presented to The Geological Society of America on May 2013. Furthermore it is clear that the BFW and assumptions for available stored water and sustainable yield for the Sutter Subbasin is wrong or at least based on unreliable data since there is abundant empirical evidence that the BFW in many places of the Subbasin is much less than 200 feet. There is only one water quality sample or water quality portion in the Appendix and that shows a NaCl TDs of 2789 at a depth of 95 to 145 feet for a well near Robbins. Literally the Water Budget for the Sutter Subbasin should be taken with a grain of salt (and in some places a concerning amount of arsenic) at this point. Regarding the empirical data we are at the early stages of quantitative analysis by unbiased independent Stakeholders but I would reference the work done in the research article " Base of fresh water, groundwater salinity, and well distribution across California" by Mary Kang, Debra Perrone, Ziming Wang, Scott Jasechiko and Melissa M. Rohde , PNAS December 22, 2020. This work is a good start to highlight the very concerning data gaps and inconsistent approaches to defining BFW levels in California and the Sacramento Valley.
7	Ben King	Member of the Public, Colusa Resident	53	11/12/2021		Figure 5-7	Public Draft GSP	The Project Area delineation is not meaningful and should be edited out. The whole of the Subbasin should be considered as one hydrological unit.
7	Ben King	Member of the Public, Colusa Resident	54	11/12/2021		5.1.7.2	Public Draft GSP	Recharge Areas Page 5-50 There is a substantial part of the Sutter Subbasin that is flooded for several winter months with substantial depths of flooding – particularly the area that comprises the Sutter Bypass and the confluence of the Sacramento River and Butte Creek flood zones. The C2VSimFG Model in the Appendix addresses flood induced groundwater infiltration for Pondered Crop effects in Section 2.5 and Model Calibration in 3.1 but the net benefit of enhanced infiltration is being missed or underestimated for the water budget subareas subject to flooding and/or seepage in the Sutter Subbasin.
7	Ben King	Member of the Public, Colusa Resident	55	11/12/2021		5.1.9	Public Draft GSP	See my previous comments regarding USGS Gamma site EASC-21 and the discussion about arsenic. This discussion needs to highlight the recent work done by the USGS on water quality, redox and the likely movement of arsenic contamination along the Willows Fault.
7	Ben King	Member of the Public, Colusa Resident	56	11/12/2021		Figure 5-27	Public Draft GSP	The Groundwater Quality Wells are not representative. There should be a time series of TDS and Arsenic contamination observations in the Appendix
7	Ben King	Member of the Public, Colusa Resident	57	11/12/2021		5.1.9.3	Public Draft GSP	There should be a table for the two contaminated wells at the Barry School and the elementary school in Meridian and the other sites with arsenic contamination observations above the MCL that I included in my previous comments. It should be noted that there is an agreement with the EPA regarding the contamination at Robbins. The second paragraph on Page 5-74 avoids making the predicted connection (see Thiros and Bexfield Model in previously supplied USGS Paper) about the connection between high pH saline water and metal oxides from volcanic rock that exist down elevation from the Sutter Buttes. Arsenic contamination is expected to occur in the Sutter Subbasin as it does in the area around Albuquerque N.M. as highlighted by the recent work of the USGS. This is also probably aggravated by translocation of arsenic along the Willows Fault which generally runs concurrent with the path of the Sutter Bypass.
7	Ben King	Member of the Public, Colusa Resident	58	11/12/2021		Figure 5-35	Public Draft GSP	This is a good Figure – the data points referenced in Figure 5-35 should be represented as a time series of observations and included in the Appendix.
7	Ben King	Member of the Public, Colusa Resident	59	11/12/2021		Figure 5-38	Public Draft GSP	These are good Figures – these data points referenced in Figure 5-38 should be represented as a time series of observations and included in the Appendix.
7	Ben King	Member of the Public, Colusa Resident	60	11/12/2021		5.1.12.4/5	Public Draft GSP	As mentioned above a large portion of the Sutter Subbasin benefits from seasonal flooding and seepage for several months during wet years. This enhanced infiltration should be included in the Water Budget by Budget subareas that encompass the seepage and/or seasonal flooding which may come with substantial flood heads and last for several months especially during wet years.
7	Ben King	Member of the Public, Colusa Resident	61	11/12/2021		Figures 5- 50 to-58	Public Draft GSP	The Project area delineation on the several Figures should be removed since the Subbasin is one hydrological unit.
7	Ben King	Member of the Public, Colusa Resident	62	11/12/2021		Figures 5-77 to 81	Public Draft GSP	Same comment as above
7	Ben King	Member of the Public, Colusa Resident	63	11/12/2021		5.2.5	Public Draft GSP	The use of median averages should not be used for determination of water quality. I may be a case for professional negligence to do so since the adverse health concentrations for water quality contamination is determined by the observations of concentrations in excess of a MCL. It could have been that the median concentration of lead contamination in Flint Michigan was below the EPA MCL but that does not mean that people were not poisoned by lead in their water systems. For the example the discussion in this Section regarding arsenic contamination is not based on a reasonable set of statistic principles because it is based on uneven sampling year sets, likely different sampling sites and the use of a median average. What should be considered is the trends of contamination above the MCL by itself – are certain water systems contaminated based on a MCL and does that trend continue based on a continuous observation time set. For example if the observations for the Meridian elementary school, the Barry School, the supply system for Robbins and the supply system for Wildwood Mutual were all 25 ug/L and six other observations were at 8 ug/L then the median average would be 8 ug/L but the school children at Meridian, Barry School and pregnant women who drank untreated water from Robbins a Wildwood would all be susceptible to arsenic poisoning. The discussion should focus on the trends in elevated arsenic observations at contaminated supply systems and wells – the use of median averages may be professional negligence.
7	Ben King	Member of the Public, Colusa Resident	64	11/12/2021		5.2.8	Public Draft GSP	As discussed above the presence of the abandoned Titan Missile silos on the north side of the Sutter Buttes should be discussed and some future work should be taken to rule out any contamination potential from the construction or decommission of the silo(s) on the adjacent GDE
7	Ben King	Member of the Public, Colusa Resident	65	11/12/2021		5-3	Public Draft GSP	As discussed above the BFW assumptions used for the Water Budget are not reasonable if Berkstresser is used. Olmstead and Davis may be acceptable for the time being but the work done by Springhorn and presented in 2013 is probably the best set of assumptions at this point in the implementation of SGMA. Additionally the enhanced infiltration from flooding and seepage should be considered for wet year scenarios in the various base assumptions. There are substantial parts of the Sutter Subbasin that have deep floodwaters for several months and/or benefit from extended seepage that sometime presents above ground near the Sacramento River and the Sutter Bypass.
7	Ben King	Member of the Public, Colusa Resident	66	11/12/2021		6.4.3.1 Pages 6-7/8	Public Draft GSP	There should be a SMC for arsenic contamination and it should be the USEPA MCL of 10 ug/L.
7	Ben King	Member of the Public, Colusa Resident	67	11/12/2021		6.4.3.2.	Public Draft GSP	The elevated pH from the saline water and the metal oxides from the volcanic rocks of the Sutter Buttes is definitely a Potential Cause for the arsenic contamination present in the Sutter Subbasin. The Sutter Yuba investigations (see previously submitted reference – this was a study published by the SWRCB in 1952) identified overpumping as far back as 1930 as a Potential Cause of elevated TDS levels in groundwater.
7	Ben King	Member of the Public, Colusa Resident	68	11/12/2021		Page 7-14	Public Draft GSP	Projects and Management Actions. Suter Buttes Salinity Monitoring PMA and Sutter Buttes Water Quality Inter-Basin Working Group PMAs. I previously submitted a PMA that was also submitted for the Colusa Subbasin GSP that focused on the worked done by Steven Springhorn relating to the stratigraphy of the Sutter Buttes in 2008. The Future Work section of Springhorn's Paper focuses on the interrelationship of the geology of the Sutter Buttes Rampart and the arsenic contamination found in the sphere of the Sutter Buttes Geomorphic Unit. The descriptions for these two PMAs should reference arsenic contamination to give it these PMAs the focus and priority they demand due to the public health consequences identified by Springhorn. The discussion about arsenic contamination should not be hidden from Stakeholders and these PMAs should be prioritized especially since they directly relate to HTRW priorities and have distinct likely negative racial equity outcomes.

Sutter Subbasin GSP Public Draft
Tracking of Comments Received as of November 15, 2021

Letter No.	Commenter	Commenter Organization	Comment No.	Date Received	Page	Section, Figure, or Table	Document	Comment
8	Ben King	Member of the Public, Colusa Resident	69	11/12/2021			Public Draft GSP, Appendix 2-A	There is not Appendix 2-A - Were there any letter comments to the SCGSA?
8	Ben King	Member of the Public, Colusa Resident	70	11/12/2021			Public Draft GSP, Appendix 4-C	There is no log of Comments from any meeting or any Comment Submittal. How are Stakeholders to be informed of other Stakeholder concerns and perspectives in order to make Comments on the Draft GSP? I have no idea if my Comments on Draft Chapters were considered and what the comments were at any meeting. There does appear to be 5 comments to the survey but that appears to be all the Comments presented to the public at during the entirety of the Comment Period for the Draft GSP. I do know that my comments to the HCM were received but I did not get a confirmation for the receipt of my PMA submittal or Comments on any draft Chapter outside of the HCM. I do not see any reference to my project submittal in the PMAs listed in the Appendix.
8	Ben King	Member of the Public, Colusa Resident	71	11/12/2021			Public Draft GSP, Appendix 4-E	Appendix 4-E The 5 comments on the Survey which comprise the totality of the Comments disclosed are interesting. Groundwater Recharge, Water for Wildlife Habitat, to be informed, green solution investment and investment in Live Oak and Farming were primary interests – all good comments. The Groundwater management concerns were about agricultural pumping causing pollution to groundwater and supply issues, overdraft, groundwater substitution and sale of groundwater to southern California, building in Live Oak and fear that the GSA will cut off well supplies.
8	Ben King	Member of the Public, Colusa Resident	72	11/12/2021			Public Draft GSP, Appendix 5-A	Appendix 5-A Note that the Welenco Log Reported a NaCl TDS of 2789 and a NaHCO3 TDS of 5000 at 95 to 145 feet near Robbins. The NaCl TDS was 3533 at 1250 feet – the TDS of the shallow well depth had the worse water quality with the exception of the 1250 well depth.
8	Ben King	Member of the Public, Colusa Resident	73	11/12/2021			Public Draft GSP, Appendix 5-G	Appendix 5-G C2VSimFG- Sutter Model Report There is a Reference error on Page 15 – Section 2.6.1 regarding diversion data. Section 3 Model Calibration - Are there any adjustments regarding vertical or horizontal flows associated with the presence of the Willows Fault? - Are there any adjustments regarding the persistence of upwelling in the Sutter Subbasin? - Why isn't there upwelling near Robbins where the salinity and arsenic contamination is the worse – any empirical work done on this to recalibrate the Model? - As discussed further in the Comments regarding the Water Budget, the Model should be calibrated for the enhanced infiltration from seasonal flooding in the Sutter Subbasin during wet years. There is substantial infiltration from seepage from the Sacramento and Feather Rivers and the Sutter Bypass. There is also substantial enhanced infiltration form seasonal flooding impacted by the confluence of Butte Creek and the Sacramento River, the high water depths of flooding in the Sutter Bypass and other flooding and seepage sites to the east of the Subbasin from the Feather River and other sites I am not so familiar with.
8	Ben King	Member of the Public, Colusa Resident	74	11/12/2021			Public Draft GSP, Appendix 6	Appendix 6 There are no graphs relating to the Groundwater Quality SMC. There should be graphs for TDS/EC for selected wells and all public supply systems and arsenic contamination for the schools and public supply systems with arsenic contamination greater than the EPA max of 10 Ug/L
8	Ben King	Member of the Public, Colusa Resident	75	11/12/2021			Public Draft GSP, Appendix 7-B	Appendix 7-B The project submittals are incomplete – there are only the Feather River Region submittals which date back 7 years to August 2014. Stakeholders have not disclosure for the basis for all the other PMAs listed in 7-A



Sutter Subbasin <info@suttersubbasin.org>

Sutter Subbasin HCM Comment No.1

Ben King <bking@pacgoldag.com>
To: "info@suttersubbasin.org" <info@suttersubbasin.org>
Cc: Ben King <bking@pacgoldag.com>

Sun, Jul 25, 2021 at 10:29 AM

Dear Sutter GSP Plan Coordinator,

My name is Ben King and my family has been farming in the Colusa Subbasin since 1860. I grew up in Colusa and I am concerned about the arsenic contamination in the public supply systems of Grimes and Princeton and the possibility that the arsenic contamination will spread to the public supply system of the City of Colusa via the Willows Fault or due to increased groundwater pumping which is likely with the further development of conjunctive groundwater pumping due to SGMA and the diversion restrictions as part of the Bay – Delta Plan.

I just reviewed the Draft HCM for the Sutter Basin and it seems that the Monitoring Network used for the Groundwater Quality assessments is not representative of the historical and empirical data that I have found in my research. I will be sending you several reports and empirical observations that need to be considered in the final HCM in my opinion.

The earliest groundwater quality data that I have found for the Sutter Basin was part of the Sutter- Yuba County Investigations which was published by the State Water Resources Board in 1952. Some of the observations go back to 1947 and 1949. This report was prompted by the report of salt water intrusion in the fresh water aquifer. On Page 38 of the Sutter- Yuba County Investigation the report states " Furthermore, when the water table is lowered by heavy irrigation pumping it is probable that upward movement of the brines is accelerated." It is my understanding that the concern about upward movement of salt water brines prompted which had existed since the 1930's prompted the transition from a ground water supply to surface water supply by the local irrigation district.

I have attached the cover for the report so that your consultants can access the report from the UC Davis Library and also included Table 20 of the Report which clearly shows an increase in EC levels southward south of the Buttes in the 3E and 2E Range south of the Sutter Buttes. You can see that the problem is most pronounced in the T12N/R2E where there is a Boron observation of 10.8 and a EC observation of 10,000

 **Sutter Yuba Investigations Table 20 Excerpt.pdf**
458K



Sutter Subbasin <info@suttersubbasin.org>

Sutter Subbasin HCM Comment No. 2

Ben King <bking@pacgoldag.com>
To: "info@suttersubbasin.org" <info@suttersubbasin.org>
Cc: Ben King <bking@pacgoldag.com>

Sun, Jul 25, 2021 at 10:54 AM

Dear Sutter Subbasin GSA Coordinator,

Attached is an excerpt of the 1971 Thesis by George Curtin "Hydrology of the Sutter Basin, Sacramento Valley, California".

I have attached the Appendix table with the water quality observations which were the basis of his report. You can see the same consistent elevated TDS/EC and Boron observations near T14N/2E and T14N/R3E. There are 4 TDS observations greater than 5000 and two Boron observations of 10.8. Magnesium and Chloride observations were also elevated. The TDS measurements would seem to be consistent with the 10,000 and 8,600 EC observations in the Sutter-Yuba Investigation Table and the Boron is the same 10.8.

2

 **1971 Curtin Water Quality Observations Excerpt.pdf**
4290K



Sutter Subbasin <info@suttersubbasin.org>

Sutter Subbasin HCM Comment No. 3

Ben King <bking@pacgoldag.com>
To: "info@suttersubbasin.org" <info@suttersubbasin.org>
Cc: Ben King <bking@pacgoldag.com>

Sun, Jul 25, 2021 at 11:51 AM

I have attached the Figures from the Sutter County Groundwater Management Plan.

Regarding the discussion regarding Arsenic, the draft HCM does not seem to reflect the observations on Figure 19 of the GMP. The HCM seems to indicate only one observation above 100 rather than the 3 observations about 100 u/gL on Figure 19. Overall the discussion does not highlight the potential health risk of the elevated observations over the USEPA MCL in public supply systems. The multi-completion well nearest the City of Sutter shows an observation of 93 u/gL at 554 feet and the multi-completion well and the multi-completion well near Robbins has an observation of 84 at 695 feet.

There is no observation for the water quality at Meridian which should be a concern since the public supply system for Grimes has an observation of 24 u/gL and because there have been elevated observations for wells on the south side of the City of Colusa.

In the report that is cited in the HCM "**Stratigraphic Analysis And Hydro Geologic Characterization of Cenozoic Strata In the Sacramento Valley Near The Sutter Buttes**" Springhorn stated the following on page 164:

"Concentrations of arsenic in 27 spatially and depth distributed samples from DWR multi-completion monitoring wells ranged from < 0.1 to 370 ug/l. Concentrations in 15 of the samples exceeded the USEPA current drinking water Maximum Contaminant Level (MCL) of 10 ug/l, and 90 percent of groundwater samples collected from wells screened in Rampart volcanoclastic material have arsenic concentrations exceeding the MCL"

My comment regarding the Arsenic discussion of the HCM is that the text of the Arsenic discussion in Springhorn's report is more consistent with the necessity to highlight the gravity of the health risk of arsenic above the USEPA MCL rather than the current discussion which does not clearly state the number of elevated occurrences nor does it highlight the potential risks to Sutter County public supply systems.

 **Sutter County GMP Figures.pdf**
3060K



Sutter Subbasin <info@suttersubbasin.org>

Sutter Subbasin HCM Comment No. 4

Ben King <bking@pacgoldag.com>
To: "info@suttersubbasin.org" <info@suttersubbasin.org>
Cc: Ben King <bking@pacgoldag.com>

Sun, Jul 25, 2021 at 1:26 PM

Dear Sutter Subbasin GSA Coordinator,

Attached is the 2014 USGS Paper 1358 “**Water Quality in Basin-Fill Aquifers of the Southwestern United States: Arizona, California, Nevada, New Mexico and Utah, 1993- 2009**”. According to the statistical model described on Page 58 of the Paper, the presence of arsenic contamination is as predicted due to the presence of volcanic rocks and groundwater with high observed levels of pH and especially under the anoxic conditions of the connate seawater surrounding the Sutter Buttes.

On Page 54 of this USGS Report it states:

“ The interaction of arsenic with metal oxides, particularly iron oxide, is one of the most important processes by which groundwater can become enriched or depleted in arsenic. When geochemical conditions favor arsenic release (desorption) from oxide surfaces, groundwater concentrations are higher than when geochemical conditions favor arsenic attachment (adsorption) to oxide surfaces. If the pH is greater than 8, arsenic tends to desorb from the iron oxides and dissolves into the groundwater. Under anoxic conditions, iron oxides dissolve and release iron and arsenic into the groundwater regardless of pH.”

Additionally, contrary to the conclusion reached in the HCM, the translocation of salt water and arsenic contamination **should be expected** as it has been observed for the public supply system of Albuquerque New Mexico.

The 2014 USGS Paper 1358 focused on Southwestern water quality also highlights the likely translocation of arsenic via Fault systems on such as the Willows Fault when it highlighted the observed translocation of arsenic contamination in the Rio Grande Basin on Pages 56 and 57 of the Paper. According to the Paper – “**The highest concentrations of arsenic in groundwater in the Middle Rio Grande Basin are associated with volcanic rocks ... and with fault zones through with deep, mineralized groundwater rises.**” Comparing this to the situation in Colusa and Sutter Counties it would make sense to infer that the source of the arsenic contamination in Princeton is related to the source of the contamination in the abandoned well Del Oro well on the south side of Colusa which is also related to the source of the contamination in Grimes and also the source for Robbins. All of these points of observed contamination lie close to the southeasterly path of the Willows Fault and are aquifers where salt water brines occupy lower stratas.



USGS 2014 Publication Regarding Water Quality Excerpt Regarding Arsenic (003).pdf
4581K



Sutter Subbasin <info@suttersubbasin.org>

Sutter Subbasin HCM Comment No. 5

Ben King <bking@pacgoldag.com>
To: "info@suttersubbasin.org" <info@suttersubbasin.org>
Cc: Ben King <bking@pacgoldag.com>

Sun, Jul 25, 2021 at 1:57 PM

Dear Sutter Subbasin GSA Coordinator,

My last comment concerns the lack of data on the portion of the Sutter Subbasin between the Sutter Buttes and the City of Colusa. As I mentioned I am particularly concerned about the potential for arsenic contamination affecting the public supply system for the City of Colusa.

My first observation is that I do not believe the HCM is working on the best available data for BFW levels. As you can see in the Springhorn attachment the DWR has updated the work done by Berkstresser in 1973. Springhorn, Hightower, Bedegrew and Bonds from the DWR presented a poster board with updated BFW contours at the The Geological Society of America in May 2013. The BFW levels in the HCM should include this update and reference this work.

Secondly the HCM should include consider the water quality data from the USGS Gamma Site EASC21 which appears to be on the Butte Slough immediately north west of the Sutter Buttes.

The water quality observations in this well support the presence of connate sea water and anoxic conditions in general. As attached, the USGS Report prepared in cooperation with the California State Water Resources Control Board "**Ground-Water Quality Data in the Middle Sacramento Valley Study Unit, 2006 – Results from the California Gama Program**" Data Series 385. On Figure 3 located in the Methods section Page 7, the location of EASC 21 observation well is shown to be slightly north west of the Sutter Buttes and very close to the Willows Fault. This well with a well depth of 369 feet has extraordinary sample observations indicating the likelihood of upwelling of connate water into the fresh water aquifer. The specific conductance of this well was 2380 uS/cm on Table 4. On Table 9 the Chloride Level was 626 mg/l and the Total dissolved solids was 1290. On Table 10 Arsenic was 80.5 ug/l, Boron was 1,010 ug/l. Perhaps most interesting was the results for Table 14 – it was the only well with a positive reading (all others had negative numeric observations) for g13O of dissolved carbonates with a reading of 5.57 (per mil).

Given these water quality observations, I would encourage the consultants working on the HCM to reconsider the level of detail in the HCM regarding the area between the Sutter Buttes and the portion of Colusa County east of the Sacramento River. In my opinion it is unfortunate that this area has been carved up into three subbasins by BBM modifications but some one has to address the complexity of the geology of the Colusa Dome and the likelihood that connate salt water and arsenic is moving vertically and laterally via the Willows Fault and/or the Sutter Buttes Rampart.

Thank you for your time and consideration

Sincerely,

Ben King

2 attachments

 **Springhorn BFW Contour Map 2013 Report.pdf**
402K

 **USGS Groundwater Quality Data 2006.pdf**
3863K



Sutter Subbasin <info@suttersubbasin.org>

Sutter Subbasin Management Action

Ben King <bking@pacgoldag.com>
To: "info@suttersubbasin.org" <info@suttersubbasin.org>
Cc: Ben King <bking@pacgoldag.com>

Sun, Jul 25, 2021 at 2:07 PM

Dear Sutter Subbasin GSA Coordinator,

Attached is a proposed Management Action that I submitted for the Colusa Subbasin. As you will see the proposed Management Action relates to both the Sutter and Colusa Subbasin's – please let me know if my submittal is acceptable since it is on the Colusa Subbasin submission form.

Thank you for your time and consideration

Best Regards,

Ben King

 **Springhorn Arsenic Study Proposed Management Action.pdf**
7511K



Sutter Subbasin <info@suttersubbasin.org>

Sutter Subbasin HCM Comment

Ben King <bking@pacgoldag.com>
To: Sutter Subbasin <info@suttersubbasin.org>
Cc: Ben King <bking@pacgoldag.com>

Thu, Aug 5, 2021 at 7:06 PM

Hi Leslie,

I wanted to make one final comment on the draft HCM for the Sutter Subbasin. While I see you have included another Figure from Harwood and Helley, I would like to suggest that you also include Figure 12 from their 1987 USGS Paper.

I would like to suggest that the relative locations of the Reverse Fault portion of the Willows Fault and the location of the Colusa Dome is important and the fact that part of the Reverse Portion is inferred because of its relative location to the City of Colusa. The location of the Colusa Dome and assumed depth is also important since it is rather shallow at its peak – 1000 ft. There is a lot going on here – not to mention the intersection of all of this with the Sacramento River and related hydrology. Since this is the most detail of this complex geology with relative locations I am suggesting that this Figure as attached be included in the HCM.

The cross section at the bottom of the figure is also informative because it identifies the type of rocks and locations in context with the volcanic structure and Colusa Dome in particular. It highlights how shallow the Tertiary Rocks are to the west towards Colusa in particular.

Thank you for your consideration.

Best Regards,

Ben

 **Scan0006.pdf**
496K



Sutter Subbasin GSP Groundwater Conditions Chapter Comments Part 1

Ben King <bking@pacgoldag.com>
To: Sutter Subbasin <info@suttersubbasin.org>
Cc: Ben King <bking@pacgoldag.com>

Fri, Aug 27, 2021 at 10:19 AM

Good Morning Leslie,

I will be submitting two set of comments today. First, I would like to comment on the data set for the presentation and analysis presented in Table 5-7. In my second email to follow, I would like to focus on the assumptions made regarding the scope of the work highlighted in the discussion for Figure 5-48 which is the excerpt from the GEI Alternative Plan on Page 5-4. Finally, I would like to question the narrow and incomplete references that were presented and apparently relied on.

Please know that some of my comments are quite critical and in some sense I want to apologize for the harshness since I know members of your staff are working very hard to finalize the GSP. I would like your staff to know that the tone of my comments come from a point of great concern about the safety of the drinking water for the water systems near the Sutter Buttes and also because I know that poor people, especially poor people of color are those who suffer the most from the power structure in small communities when there is great economic incentive to look the other way. This was my experience growing up in Colusa and unfortunately I think arsenic contamination risks for the Sutter Subbasin are being intentionally downplayed.

Thank you for your time and the opportunity to submit these comments.

Table 5-7 Comments:

1: The Draft Groundwater Conditions Chapter appear to be a material deviation from the breadth of the previous work done by Woodward and Curran in the Sutter Subbasin GMP. Rather than build upon the breadth of data presented in the GMP and update the GMP with the work of Springhorn and the recent work of the USGS by Susan Thiros and Laura Bexfield regarding Water Quality in Basin Fill Aquifers and Groundwater Availability in the Central Valley, this Draft seems to be beholden to the GEI Alternative Plan and attempt to limit the data set and new research to justify the constraints of the GEI Alternative Plan. The GEI Alternative Plan appears to an advocacy document intended to try to exempt the Sutter Basin from material SGMA requirements. I would encourage Woodward and Curran to expand the data set and update the work done in the Sutter GMP in its development o of the GSP for the Sutter Subbasin.

2 On Page 45 of the Draft the following statement is made: "Median concentrations of arsenic have decreased since 1952 and most recently are below the Primary MCL". There is no basis for this statement - what could be said is – Based on a selected data set of 28 recent measurements over a selected 7 year period. the median observation has decreased since 1952 when compared to the median of the 115 observations analyzed for the last 60 years.

Furthermore you could say that the median observation of the data set for selected 3 year period was dropped from being nearly twice the allowed USEPA MCL to 70% of the USEPA MCL!! What is not discussed is how could this

happen? After decades of upwelling, redox, metal oxide desorption, increased groundwater pumping due to conversion to permanent plantings the Sutter Subbasin experience a 63% decline in groundwater arsenic contamination!. What is in the water that seems to indicate that principles of redox and arsenic desorption seem to have changed over the last 7 years? Why does the Table compare a 56 year period with 77 data points to a 3 year period with 38 data points to a 7 year period with 28 data points?

3. Regarding the data set the source is noted as GAMA (SWRCB,2021). What part of GAMA is this – there is no notation of this source in the Reference Section. GAMA has a history back to 2004 and a change of focus in 2012. Was the 1952-2008 data from GAMA and what part of GAMA?

4. It appears that most of the data cites in 5-81,82,83 and 84 are intended to be from the 2008 Sacramento Valley GAMA publication but this report does not appear to be cited nor do the measurements presented on this Figures appear to be correct in all cases. Was it intended to use the 2008 USGS publication for the reported observations? If so – perhaps this report should be cited and put in the Reference Section.

5. The water quality figures of the Sutter Subbasin GMP cite USGS (GAMA), DWR, SEWD, DHS, FAQ and the USEPA. It seems that Table 5-7 is limited to the USGS (GAMA) via the SWRCP data set? How about the SWRCB data set for MCL violations for public water systems. Are the water quality observations for the Barry School well near Yuba City or the Sutter County Public Water Systems included in Table 5-7? Specifically:

- Barry School Well . In 2015 Tom Butcher Director of Maintenance said that the arsenic contamination problem is not solved and is giving bottled water to students (Arsenic in California Drinking Water Page 16 , September 2016)
- Sutter Co. WWD#1 (Robbins) Public Water System 5100107
- Wildwood Mutual Water Company PWS 5100109
- City of Live Oak PWS 5110001
- Yuba City Groundwater- Region 2-3 PWS 511003

6. On Page 5-46, it is stated “ ..water quality objectives identified in Table 5-7 for the purpose of using a common metric for the highest beneficial use, which is drinking water.” Shouldn't the fact that Sutter County has entered in an agreement with the USEPA regarding Robbins be discussed as a current condition. How about the fact that students were given bottled water outside of Yuba City as late as 2015? How about the fact the USEPA has cited the portion of the sewage system dependent on groundwater for an arsenic violation? The Primary MCL violation for the City of Live Oak. The Arsenic violation for the Wildwood water system near Yuba City? None of this is mentioned in the Draft? Were any of these measurements included among the 28 measurements referenced for the 2013-2020 period of Table 5-7?

7. Figure 5-81 The grouping of the observations for Rice 20 and Rice 01 should be separated since the Rice 01 observations are material and extraordinary. It should be noted that that Rice 01 had an arsenic observation of 8 ug/L which is close to the USEPA MCL even though it has a well depth of 50 feet. The TDS level is reported to be 7390 which is again extraordinary and indicates that arsenic desorption is likely to be occurring with a high pH and high TDS. It is also extraordinary that the TDS level for Rice 20 is more than 10 times less even though there are near the same latitude. Perhaps this could have something to do with the up-whelling and possible transmission of connate water via the Willows Fault as the Sutter Subbasin elevation declines southwardly. Please note that the TDS levels reported for 2006 GAMA observations are different from those Table 9 Page 60 of the USGS 2008 Report. Also please separate Rice 01 with its own data box – there is plenty of room on the lower right side of the Figure on top of the North American basin portion of Figure 5-81.

8. Figure 5-83 There is material omission by not including GAMA EASC 21. The 2006 observations were : Arsenic 80.1 ug/L Boron 1,010 ug/L (Table 10 Page 61 USGS GAMA 2008) and TDS 1290 (Table 9 Page 58 USGS GAMA 2008). For the EASC 19 there is a 2006 reading of 96 on Table 10 but the data cited is a 2001 observation. The same is true for TDS – the 2006 observation is 306 . For the companion 15N well there is no data mentioned for arsenic – perhaps

there should be a NA if not available. For EASC 29, the TDS level reported on Table 9 appears to be 297 which is different than the 2006 reported observation by a small amount.

7

4 attachments**USGS GAMA 2006 Observations.pdf**

2160K

**Woodward & Curran Sutter GMP Data Sources.pdf**

1040K

**Barry School Arsenic Report.pdf**

1012K

**SWRCB Water System MCL Violation Funding Report Excerpt.pdf**

841K



Suttter Subbasin GSP Groundwater Conditions Chapter Comments Part 2

Ben King <bking@pacgoldag.com>
To: Sutter Subbasin <info@suttersubbasin.org>
Cc: Ben King <bking@pacgoldag.com>

Fri, Aug 27, 2021 at 4:09 PM

Hi Leslie,

Here are the 2nd part of my Comments on the Draft Chapter:

1. Generally the Draft Chapter ignores the geology and geochemistry of the Sutter Buttes volcanic structure and Rampart as well as the tectonic features of the Willows Fault. The statement in the box for Figure 5-48 on the GEI slide from the Alternative Plan highlights the deficient perspective of the Draft Chapter. The Basin Boundary Modifications approved by the DWR to incorporate the Sutter Subbasin Project Area rightly with the Sutter Subbasin as a whole was material and extremely consequential. There is extensive empirical data and research to take a position strongly disagreeing with the conclusion made in the following statement. "Such Modifications (referring to the 2019 BBM) have not resulted in material changes that would alter understanding of basin conditions." The BBM Modification added : (1) an 2 million year old volcanic structure at the valley floor of an in-fill basin, (2) connate sea water that is upwelling around the volcano and likely moving laterally down the decent of the Valley floor and possibly via the fault structure and (3) an active fault in the Willows Fault that is located between the Sutter Buttes Rampart and the City of Colusa that has a spur that goes under the Sacramento River and under the City of Colusa with the major fault line moving through the length of the entirety of the Sutter Subbasin mostly within the major flood zone of the Sutter Bypass and (4) the geologic structure of the Colusa Dome with shallow and uncertain vertical aquifer depths.
2. Some empirical observations to consider : (a) GAMMA Site EASC 21 with elevated trace metal observations and water chemistry that may indicate the upwelling of anoxic sea water into normal well depths located on the banks of the environmentally important Butte Creek, (b) a BBM comment that the domestic well for the Colusa Shooting Club on Laux Road has a reverse osmosis filter to treat well water and (c) a report from a local landowner on Laux Road that a neighbor brought up saltwater from a new 500 foot well that killed fish.
3. Refer to " Sutter Buttes – The Lone Volcano in California's Great Valley" USGS – Reducing the Risk From Volcano Hazards by Brian Hausback and Patrick Muffler March 2011. Understanding the unique location of the Sutter Buttes in the Sacramento Valley watershed should inform GSP development.
4. Refer to " Geochemisty of Ground Water in the Sacramento Valley, California by Laurence C. Hull , USGS Publication 1984 - The Sutter Buttes are identified as one of 8 unique Geomorphc Units on Page B4. On Page B10 – " The Sutter Basin facies is tied with the south alluvial fan facies for the highest average dissolved solids concentration. This facies is also high in sodium, chloride, bicarbonate, potassium and boron. The effect of reducing concentrations are evident in the relatively higher concentrations of iron, manganese, and arsenic in this area, all of which are more soluble in reducing environments (Garrels and Christ, 1965). The very low average nitrate concentration in this facies is also indicative of reducing conditions, where nitrate can be removed by denitrification reactions. The origin of the high dissolved-solids water is thought to be connate marine water moving upward along fault lines created when Sutter Buttes was emplaced (Curtin, 1971) " Got to take the shot at conclusions based on Table 5- 7 in the Draft Chapter – REALLY????

8

5. Refer to "Hydrogeology of the Sutter Basin, Sacramento Valley< California by George Curtin. Master Thesis, University of Arizona – this is the reference for Hull. Can one publish a Draft for Groundwater Conditions for the Sutter Basin and not discuss the findings of a Hydrology Professor about the Sutter Basin?
6. Refer to "Late Cenozoic Tectonism of the Sacramento Valley, California by David Harwood and Edward Helley USGS 1987 See Page 16 for the discussion regarding the relationship between the Willows Fault and the Colusa Dome. The vertical depths of the groundwater aquifer around the Sutter Buttes and on top of the Colusa Dome structure should be addressed in the Draft Chapter
7. Refer to "Stratigraphic Analysis and Hydrogeologic Characterization of Cenozoic Strata in the Sacramento Valley Near the Sutter Buttes" by Steven Taylor Springhorn, Masters Thesis, CSU, Sacramento 2008. Refer to the discussion on Page vii of the Abstract " The presence of brackish water in these deeper aquifers combined with upward vertical gradients creates the potential for continued upward migration of brackish water into overlying fresh water aquifers, or upconing beneath areas of pumping . Prolonged well pumping in these areas is likely to result in regional water quality degradation and may ultimately reduce the thickness of fresh groundwater in the Sacramento Valley" On Page 163 "Data analyses suggest there is a connection between elevated arsenic concentrations in groundwater and the presence of the Sutter Buttes Rampart volcanoclastic material (which is derived from silicic and intermediate volcanic rocks)."
8. Refer to "Water Quality in Basin-Fill Aquifers of the Southwestern United States: Arizona, California, Colorado, Nevada, New Mexico and Utah, 1993-2009" by Susan Thiros, Angela Paul, Laura Bexfield and David Anning USGS 2014 See the similarity of the Sutter Subbasin to the Middle Rio Grande Basin on Page 56 " Groundwater circulating at depth in the Middle Rio Grande Basin has high concentrations of arsenic, chloride and other elements. This deep ground water comes into contact with shallower groundwater where it flows upward, primarily along fault zones throughout the basin." See Page 59 regarding the predictive model described on Page 58 where high concentrations of arsenic are predicted in an topographical area like Robbins = " Arsenic concentrations greater than the MCL are more likely to occur in basin lowlands than in other parts of the basin because of longer residence time in the aquifer and geochemical reactions between the groundwater and arsenic-bearing sediment."

8

Comment Regarding Section 5.2.2.3 Groundwater Trends

1. The SWRB Report "Sutter-Yuba Counties Investigation" SWRB Bulletin No. 6 1952 made clear that the upward movement of saline water is not a trend but a well known fact. This report based on work primarily done in 1949 and published in 1952 made this statement on Page 32 under Quality of Water. "**With respect to ground water supplies, however (compared to surface water discussed in the previous sentence) , salinity sufficient to impair use of the ground water for irrigation, domestic, and many industrial uses has been observed at scattered wells throughout the area for many years**". After approximately 80 years maybe it is time to stop calling it a trend and focus on the trend in degraded groundwater quality caused by upwelling?
2. Refer to "Effects of Natural and Human Factors on Groundwater Quality of Basin-Fill Aquifers in the Southwestern United States – Conceptual Models for Selected Contaminants" by Laura Bexfield, Susan Thiros, Jena Huntington, and Tim McKinney USGS 2011 Refer to Page 54 for the discussion regarding TDS. Refer to Page 59 for the discussion regarding Arsenic See Page 44 " How Redox Conditions are Determined " regarding the important role Redox conditions have on water quality. Based off approximately 80 years of connate saline water redox – Bexfield's report can provide great scientific analysis to be included in the Draft Chapter regarding Groundwater Conditions.

9



Sutter Subbasin GSP Groundwater Conditions Comments Part 3

Ben King <bking@pacgoldag.com>
To: Sutter Subbasin <info@suttersubbasin.org>
Cc: Ben King <bking@pacgoldag.com>

Fri, Aug 27, 2021 at 4:30 PM

Comments Regarding the Reference List.

Please refer to the reports referenced for the full citation for suggested references to be included and analyzed when completing the final draft of the Chapter.

Since this Draft Chapter is about the Sutter Subbasin the previous work specifically focused on the Sutter Subbasin should have the respective findings discussed and analyzed in the Chapters of the GSP. There are three reports that should be referenced:

1. Sutter-Yuba Counties Investigation
2. Hydrogeology Of The Sutter Basin, Sacramento Valley, California
3. Stratigraphic Analysis And Hydrogeological Characterization of Cenozoic Strata in the Sacramento Valley Near the Sutter Buttes

The Following USGS Papers should be referenced:

1. Hull – Geochemistry of Groundwater in the Sacramento Valley, California 1984 for the geochemical foundation of the influence of the Sutter Buttes on the Sutter Basin groundwater quality
2. Harwood and Helley – Late Cenozoic Tectonism of the Sacramento Valley, California 1987 for the foundational analysis of the Willows Fault and the interrelationship with the Colusa Dome
3. Thiros et al. – Water Quality in Basin-Fill Aquifers of the Southwestern United States: Arizona, California, Colorado, Nevada, New Mexico and Utah, 1992 -2009, 2014 for the discussion on the chemical basis of desorption of arsenic and the lateral movement of connate water and arsenic via faults
4. Bexfield et. al – “ Effects of Natural and Human Factors on Groundwater Quality of Basin-Fill Aquifers in the Southwestern United States, 2011 for the discussion on the redox and saline unphwelling identified in the Sutter-Yuba Counties Investigation. Also for the discussion regarding arsenic contamination. When referring to this Report consider the fact that these hydrochemical processes have been occurring at least since the 1940's and for “many years prior” to the report in 1952. Perhaps a 100 years of Redox in the Sutter Subbasin?



State of California – Natural Resources Agency
DEPARTMENT OF FISH AND WILDLIFE
North Central Region/Region 2
1701 Nimbus Road
Rancho Cordova, CA 95670
www.wildlife.ca.gov
[\(916\) 358-2900](tel:(916)358-2900)

GAVIN NEWSOM, Governor
CHARLTON H. BONHAM, Director



November 8, 2021

Guadalupe Rivera
Sutter Subbasin
1130 Civic Center Boulevard
Yuba City, CA 95933
grivera@co.sutter.ca.us

Subject: CALIFORNIA DEPARTMENT OF FISH AND WILDLIFE COMMENTS ON THE SUTTER SUBBASIN DRAFT GROUNDWATER SUSTAINABILITY PLAN

Dear Mr. Rivera:

The California Department of Fish and Wildlife (Department) appreciates the opportunity to provide comments on the Sutter Subbasin Draft Groundwater Sustainability Plan (GSP) prepared by the Sutter County Groundwater Sustainability Agency (GSA), Butte Water District GSA, City of Live Oak GSA, Sutter Extension Water District GSA, Sutter Community Services District GSA, City of Yuba City GSA, Reclamation District No. 70 GSA, Reclamation District No. 1500 GSA, and Reclamation District No. 1660 GSA pursuant to the Sustainable Groundwater Management Act (SGMA). The Basin is designated as medium priority under SGMA and must be managed under a GSP by January 31, 2022.

The Department is writing to support ecosystem preservation and enhancement in compliance with SGMA and its implementing regulations based on Department expertise and best available information and science. As trustee agency for the State's fish and wildlife resources, the Department has jurisdiction over the conservation, protection, and management of fish, wildlife, native plants, and the habitat necessary for biologically sustainable populations of such species (Fish & Game Code §§ 711.7 and 1802).

Development and implementation of GSPs under SGMA represents a new era of California groundwater management. The Department has an interest in the sustainable management of groundwater, as many sensitive ecosystems, species, and public trust resources depend on groundwater and interconnected surface waters (ISWs), including ecosystems on Department-owned and managed lands within SGMA-regulated basins.

SGMA and its implementing regulations afford ecosystems and species specific statutory and regulatory consideration, including the following as pertinent to GSPs:

- GSPs must **consider impacts to groundwater dependent ecosystems** (GDEs) (Water Code § 10727.4(l); see also 23 CCR § 354.16(g));
- GSPs must consider the interests of all beneficial uses and users of groundwater, including environmental users of groundwater (Water Code § 10723.2) and GSPs must **identify and consider potential effects on all beneficial uses and users of**

Sutter Subbasin
November 8, 2021
Page 2 of 12

- groundwater** (23 CCR §§ 354.10(a), 354.26(b)(3), 354.28(b)(4), 354.34(b)(2), and 354.34(f)(3));
- GSPs must **establish sustainable management criteria that avoid undesirable results** within 20 years of the applicable statutory deadline, including **depletions of interconnected surface water that have significant and unreasonable adverse impacts on beneficial uses of the surface water** (23 CCR § 354.22 *et seq.* and Water Code §§ 10721(x)(6) and 10727.2(b)) and describe monitoring networks that can identify adverse impacts to beneficial uses of interconnected surface waters (23 CCR § 354.34(c)(6)(D)); and
 - GSPs must **account for groundwater extraction for all water use sectors**, including managed wetlands, managed recharge, and native vegetation (23 CCR §§ 351(a) and 354.18(b)(3)).

Furthermore, the Public Trust Doctrine imposes a related but distinct obligation to consider how groundwater management affects public trust resources, including navigable surface waters and fisheries. Groundwater hydrologically connected to surface waters is also subject to the Public Trust Doctrine to the extent that groundwater extractions or diversions affect or may affect public trust uses. (*Environmental Law Foundation v. State Water Resources Control Board* (2018), 26 Cal. App. 5th 844; *National Audubon Society v. Superior Court* (1983), 33 Cal. 3d 419.) The GSA has “an affirmative duty to take the public trust into account in the planning and allocation of water resources, and to protect public trust uses whenever feasible.” (*National Audubon Society, supra*, 33 Cal. 3d at 446.) Accordingly, groundwater plans should consider potential impacts to and appropriate protections for ISWs and their tributaries, and ISWs that support fisheries, including the level of groundwater contribution to those waters.

In the context of SGMA statutes and regulations, and Public Trust Doctrine considerations, groundwater planning should carefully consider and protect environmental beneficial uses and users of groundwater, including fish and wildlife and their habitats, GDEs, and ISWs.

The Department recognizes and appreciates the effort of the GSAs to characterize current and projected groundwater conditions within the subbasin. However, the Department believes the GSP could improve its considerations of environmental users of groundwater and establish more protective management criteria. The Department is providing additional comments and recommendations in Attachment A.

If have any questions related to the Department’s comments and/or recommendations on the Sutter Subbasin Draft GSP please contact Bridget Gibbons, Environmental Scientist, at bridget.gibbons@wildlife.ca.gov.

Sincerely,

DocuSigned by:

A2A0A9C574C3445...

Kevin Thomas
Regional Manager, North Central Region

Enclosures (Attachments A, B)

Sutter Subbasin
November 8, 2021
Page 3 of 12

ec: California Department of Fish and Wildlife

Joshua Grover, Branch Chief
Water Branch
Joshua.Grover@wildlife.ca.gov

Robert Holmes, Environmental Program Manager
Statewide Water Planning Program
Robert.Holmes@wildlife.ca.gov

Angela Murvine, Statewide SGMA Coordinator
Groundwater Program
Angela.Murvine@wildlife.ca.gov

Jennifer Garcia, Environmental Program Manager
North Central Region
Jennifer.Garcia@wildlife.ca.gov

Briana Seapy, Water Program Supervisor
North Central Region
Briana.Seapy@wildlife.ca.gov

Bridget Gibbons, Environmental Scientist
North Central Region
Bridget.Gibbons@wildlife.ca.gov

California Department of Water Resources

Craig Altare, Supervising Engineering Geologist
Sustainable Groundwater Management Program
Craig.Altare@water.ca.gov

M. Katy Janes, Sutter Subbasin SGMA Point of Contact
North Central Region Office
Margaret.Janes@water.ca.gov

Groundwater Sustainability Agencies

Sutter County
grivera@co.sutter.ca.us

Butte Water District
morme@buttewater.net

City of Live Oak
ndelerio@yubasutterlaw.com

Sutter Subbasin
November 8, 2021
Page 4 of 12

Sutter Extension Water District
lphillips@sutterewd.com

Sutter Community Services District
sutterwater@aol.com

City of Yuba City
kwillis@yubacity.net

Reclamation District Nos. 70 and 1660
aduffey@succeed.net

Reclamation District No. 1500
brad@sutterbasinwater.com

National Marine Fisheries Service

Rick Rogers, Fish Biologist
West Coast Region
Rick.Rogers@noaa.gov

State Water Resources Control Board

Natalie Stork, Chief
Groundwater Management Program
Natalie.Stork@waterboards.ca.gov

Attachment A

CALIFORNIA DEPARTMENT OF FISH AND WILDLIFE COMMENTS ON THE SUTTER SUBBASIN DRAFT GROUNDWATER SUSTAINABILITY PLAN

COMMENTS AND RECOMMENDATIONS

The Department's comments are as follows:

1. **Comment #1 – Interconnected Surface Water Systems** (5.2.7 Interconnected Surface Waters; starting page 5-169): The GSP does not include an estimate of the quantity and timing of depletions of interconnected surface water systems as required by 23 CCR § 354.16(f).
 - a. Issue: The GSP identifies the Feather River, Sacramento River, and Sutter Bypass as interconnected surface waters and assesses whether stream segments are primarily gaining, losing, or mixed. However, the GSP does not include information related to the quantify and timing of depletions from these interconnected surface waters as required by 23 CCR § 354.16(f).
 - b. Recommendation: The Department recommends that the GSP include a table quantifying the volume of surface water depletions, by month, for all interconnected surface waters identified within the subbasin.

2. **Comment #2 – Groundwater Dependent Ecosystems** (5.2.8 Groundwater Dependent Ecosystems; starting page 5-173): Groundwater dependent ecosystem (GDE) identification, required by 23 CCR § 354.16(g), is based on methods that risk exclusion of ecosystems that may depend on groundwater.
 - a. Issues:
 - i. Depth to Groundwater Threshold: The GSP relies on a groundwater level threshold of 30-feet below the ground surface (bgs) to screen potential GDEs within the subbasin. However, mature Valley Oak (*Quercus lobata*) can access groundwater up to 80 feet bgs (Howard 1992, Lewis & Burgy 1964). The use of a 30-foot threshold may incorrectly exclude Valley Oak communities within the subbasin from further consideration as a GDE. Additionally, the GSP does not specify if the groundwater level data used for the depth to groundwater analysis is based on spring or fall groundwater measurements.
 - ii. GDEs Near Surface Water: The GSP eliminates potential GDE areas located within 150 feet of surface waters, within 150 feet of irrigated rice paddies, and within 50 feet of other irrigated croplands, Fish and Wildlife Service-irrigated land, and State-

11

12

13

irrigated land. This GDE-elimination method may disregard a GDE's adaptability and opportunistic approach to accessing water in which vegetation and ISW may rely on *both* surface water and groundwater across seasons and years.

13

- iii. GDE Identification by Year: The GSP assesses potential GDE areas identified in the Natural Communities Commonly Associated with Groundwater (NCCAG) dataset across three years: 2013, 2015, and 2017. For each year, the GSP removes NCCAG areas based on the depth to groundwater and proximity to surface water/irrigated lands elimination criteria; remaining NCCAG areas are identified as "potential GDEs." This process essentially creates three different sets of potential GDE locations within the subbasin, one for each of the years evaluated, intended to represent a range of dry to wet years. It is unclear whether the GSP requires an area to be identified as a potential GDE in all three of the years evaluated to be retained as a GDE for monitoring and management actions in the GSP, or if an area identified as a potential GDE in one or two of the three years would be retained as a GDE. For instance, an area identified as a potential GDE in 2017, a wet year, may not have had access to groundwater supplies during 2015, a critically dry water year in which groundwater levels reached historic lows. A lack of groundwater access during dry years does not negate an area's status as a GDE; if GDE areas must be confirmed across all three representative water years to be managed in the GSP, the plan's methodology may incorrectly eliminate potential GDEs based on their inability to access groundwater at a single point in time during a critically dry year.
- iv. Special Status Species: Though the GSP includes a list of freshwater species within the Sutter Subbasin, the GSP does not assess the species' potential groundwater dependence or their spatial extent within the subbasin.

14

15

b. Recommendations:

- i. Depth to Groundwater Threshold: The Department recommends the GSP update the methodology for classifying GDEs to reflect accurate maximum potential rooting depth for Valley Oak communities. For areas of Valley Oak within the subbasin, the Department recommends the GSP apply a threshold of 80 feet bgs as the maximum depth at which the potential GDE could access groundwater. The Department accepts the use of a 30-foot threshold for other potential GDE areas within the subbasin that do not contain Valley Oak. The GSP should also explicitly identify

12

which groundwater level measurements were used for the depth to groundwater analysis; the Department recommends the analysis rely on spring, or seasonal high, groundwater levels to be inclusive of potential GDEs.

12

- ii. GDEs Near Surface Water: The Department recommends that the GSP err on the side of inclusivity of potential GDEs until there is site specific evidence that the overlying ecosystem has no significant dependence on groundwater across seasons and water year types. This means not ruling out potential GDEs because they are proximate to surface water.
- iii. GDE Identification by Year: The Department recommends the GSP clarify the GDE identification methodology and explain if areas identified as GDEs in each of 2013, 2015, and 2017 are retained for further analysis, or if only areas identified in all three years are considered GDEs for the remainder of the GSP.
- iv. Special Status Species: The Department recommends the GSP include an assessment of each identified species' likely groundwater dependence. The GSP should also include a spatial assessment of special status species within the subbasin to characterize which surface waters or GDE areas provide these species habitat or forage; this level of GDE-species-relationship assessment enables GSAs to prioritize GDE monitoring and management decisions.

13

14

15

3. Comment #3 – Sustainable Management Criteria (6.5.6 Depletions of Interconnected Surface Water; starting page 6-36): Interconnected surface water sustainable management criteria (SMC) may not protect against undesirable results for fish and wildlife beneficial uses and users.

a. Issues:

- i. Minimum Thresholds: Minimum thresholds (MTs) for ISW, using groundwater levels as a proxy, are set either at the historic low over the period of record, at 90% of the average groundwater elevation with a modeled increase in evapotranspiration of 50%, or at a level necessary to provide a sufficient operating range below the measurable objective. The GSP's methodology assumes that undesirable results were not occurring at the historic low; however, the GSP does not include sufficient analysis or discussion to support this claim. In 2015, the second of back-to-back critically dry water years in the Sacramento Valley which resulted in historical low groundwater levels, vegetated and aquatic GDEs experienced adverse impacts including stressed or dying riparian vegetation,

16

poor instream habitat availability, and increased water temperatures (DFW 2019). It is unclear what, if any, studies or analyses were completed to assess whether environmental users within the subbasin experienced undesirable results at the historical low groundwater levels. The GSP assumes that undesirable results for ISW occur only when gaining streams become losing streams. This assumption ignores the benefits of groundwater contributions to surface water baseflows, including the maintenance of instream water quality and temperatures. Reducing the volume of groundwater contributions to ISW, even if a reach has not yet changed from gaining to losing or disconnected, would likely result in significant and unreasonable impacts to fish and wildlife beneficial users of ISW prior to exceedance of the MT. As the GSP neither characterizes specific instream flow or habitat requirements for aquatic species, nor provides baseline information on the volume and timing of ISW depletion (See Comment #1), nor discusses the anticipated rates of depletion that would occur at the established MTs; there is insufficient information to assess potential impacts to ISW beneficial uses and users. The ISW SMC are also regarded in the GSP as protective of GDE beneficial users of groundwater, but the GSP does not provide evidence to support this claim. No analysis is presented that characterizes whether the established MTs are sufficient to maintain water groundwater levels that have historically been shallow enough to support GDEs, or if the MTs would permit groundwater levels to fall below root zones, removing groundwater as an available water source to some GDEs. If MTs are not protective of GDE access to groundwater supplies, significant impacts to environmental beneficial users of groundwater will likely be experienced before MTs are reached.

- ii. Undesirable Results: The GSP requires 25% of ISW representative monitoring wells in the subbasin to fall below their MTs for two consecutive seasonal high water level measurements before identifying an undesirable result to GDEs or ISW. While environmental users are usually adapted to sustain short-term lowering of groundwater levels during dry periods, environmental users may not be able to sustain extended periods of reduced groundwater access that would result from allowing groundwater levels to fall to historic lows or deeper for two consecutive years. Under these MTs, by the time an undesirable result is declared and management actions are triggered in response to the undesirable

16

17

- result, environmental groundwater users will have already experienced significant stress and potentially irreversible mortality.
- iii. Environmental Beneficial Users: Though the GSP does discuss the potential impacts of exceeding the established SMC for each sustainability indicator on environmental beneficial uses and users within the subbasin, the GSP does not present sufficient evidence that the MTs will protect against these impacts. For instance, the GSP states that if groundwater level or ISW MTs are exceeded, GDEs could lose access to groundwater and aquatic ecosystems could experience a reduction in suitable habitat through lowered stream depths, flow velocities, and dissolved oxygen; and increased temperatures (pages 6-46). However, in establishing the MTs, the GSP seemingly does not compare the groundwater level or ISW thresholds to GDE rooting depths, nor does the GSP relate the MTs to rates of depletion of surface waters and the associated impacts on instream flows, water temperatures, or the availability of suitable habitat for aquatic species.
- b. Recommendations:
- i. Minimum Thresholds: The Department recommends the GSP reselect minimum thresholds that would better protect environmental uses and users of groundwater, rather than enabling declines in groundwater levels over the implementation horizon beyond the historic low. Additional analyses of the specific impacts of the established thresholds on monthly groundwater contribution to baseflow in gaining streams, monthly depletion of losing streams, and on GDE and ISW beneficial users of groundwater should be included.
- ii. Undesirable Results: The Department recommends the GSP reconsider the two seasonal-high measurements of groundwater levels below MTs required to constitute an undesirable result, recognizing that extended durations of groundwater inaccessibility for environmental users will likely lead to adverse impacts that cannot be easily reversed when groundwater levels recover. At a minimum, the Department recommends identifying physical triggers (e.g., declining Normalized Difference Vegetation Index signals) and associated management actions (e.g., demand reduction) to enable the GSAs to identify and mitigate localized patterns of lowering groundwater or depleted ISW and associated negative impacts before the second year of MT exceedances yields more significant and undesirable impacts. These interim action triggers

17

18

16

17

will help preempt irreversible losses and undesirable results for environmental users.

17

- iii. Environmental Beneficial Users: The Department recommends the GSP include specific analysis demonstrating that the established SMCs are sufficiently protective of environmental users of groundwater, including GDEs and ISW. Groundwater level and ISW MTs at each representative monitoring well (See Comment #5) should be compared to the rooting depths of the identified vegetation in nearby GDEs. The GSP should quantify the volume and timing of depletions of ISW that would occur at the established MTs and explicitly discuss the impacts of the projected depletions on aquatic species' streamflow, water temperature, and habitat needs.

18

4. Comment #4 – Projects and Management Actions (PMAs)(7.1.3 Summary of Projects and Management Actions; starting page 7-3): The GSP should include additional potential PMAs related to the implementation of demand management within the subbasin.

- a. Issue: The planned and ongoing PMAs within the subbasin focus largely on modernizing water systems operations or implementing recharge projects that may be costly, rely on securing additional surface water supplies, and/or require potentially lengthy permitting processes. Though the GSP indicates that in the projected future conditions scenario, the Sutter Subbasin is expected to maintain groundwater sustainability, should projects fail to produce the anticipated groundwater benefit or localized undesirable results occur, it may be necessary to implement additional demand management projects.
- b. Recommendation: The Department recommends identifying additional demand management projects as potential PMAs that could be implemented within the subbasin. The Department supports a balanced approach of projects related to both supply augmentation and demand management for managing the subbasin sustainably.

19

5. Comment #5 – Monitoring Networks (7.1.4.6 Installation of Additional Shallow Groundwater Monitoring Wells, 7.2.6.1 Groundwater Level Monitoring Network, 7.2.6.6 Interconnected Surface Water Monitoring Network; starting pages 7-56, 7-114, and 7-148): The GSP should include an assessment of the adequacy of the monitoring networks for assessing impacts to GDEs. The GSP should include additional information related to the planned project to improve the monitoring network for GDEs and ISW within the subbasin.

20

- a. Issue: The GSP does not include a discussion of the adequacy of the monitoring network for assessing potential impacts to GDEs throughout the subbasin. It is unclear whether any of the identified representative monitoring sites for groundwater levels or ISW are located sufficiently near to GDEs to monitor shallow groundwater levels in those areas. While the Department acknowledges the planned installation of 15 additional shallow wells to improve monitoring of ISW and GDEs, the discussion of the locations of these additional wells focuses on filling data gaps related to ISW and does not discuss planned well locations relative to GDEs within the subbasin.
- b. Recommendation: The GSP should include additional detail related to adequacy of the existing representative monitoring networks for assessing shallow groundwater conditions and potential impacts to GDEs. The Department recommends that the GSP assess the locations of special status species within the subbasin to determine which GDE areas likely provide priority habitat. GDE areas and ISW that support special status species or are most at risk of negative impacts due to groundwater pumping should be prioritized for monitoring to inform management actions (See Comment #2(iv)).

20

CONCLUSION

In conclusion, though the draft GSP provides detailed characterization of subbasin groundwater conditions, the GSP lacks a robust analysis of potential impacts to environmental beneficial users and should establish more protective management criteria. The Department recommends that the Sutter Subbasin GSAs address the above comments before GSP submission to DWR to best prepare for the following regulatory criteria for plan evaluation:

1. The assumptions, criteria, findings, and objectives, including the sustainability goal, undesirable results, minimum thresholds, measurable objectives, and interim milestones are not reasonable and/or not supported by the best available information and best available science (23 CCR § 355.4(b)(1)). (See Comment #1, 2, 3)
2. The GSP does not identify reasonable measures and schedules to eliminate data gaps. (23 CCR § 355.4(b)(2)) (See Comment #5)
3. The interests of the beneficial uses and users of groundwater in the basin, and the land uses and property interests potentially affected by the use of groundwater in the basin, have not been considered. (23 CCR § 355.4(b)(4)) (See Comment #1, 2, 3)

4. The projects and management actions are not feasible and/or not likely to prevent undesirable results and ensure that the basin is operated within its sustainable yield. (23 CCR § 355.4(b)(5)) (See Comment #4) **Attachment B**

LITERATURE CITED

Department of Fish and Wildlife. 2019. Statewide Drought Response: Stressor Monitoring.

Howard, Janet L. 1992. *Quercus lobata*. In: Fire Effects Information System. U.S. Department of Agriculture, Forest Service, Rocky Mountain Research Station, Fire Sciences Laboratory.

Lewis, D.C. & Burgy, R. H. 1964. The Relationship between Oak Tree Roots and Groundwater in Fractured Rock as Determined by Tritium Tracing. *Journal of Geophysical Research*. 69(12):2579-2588.



November 11, 2021

Guadalupe Rivera
Sutter County Development Services
1130 Civic Center Blvd
Yuba City, CA 95993
Sent via email to: info@suttersubbasin.org

Re: Comments on the Draft Sutter Subbasin Groundwater Sustainability Plan

To Sutter Subbasin GSAs,

Audubon California appreciates the opportunity to provide public comment on the draft Sutter Subbasin Groundwater Sustainability Plan (GSP) prepared by the nine Groundwater Sustainability Agencies (GSAs), collectively referred to hereafter as the “Sutter GSAs”. Audubon California is a statewide nonprofit organization with a mission to protect birds and the places they need. Our organization has a long history of solutions-focused work in the Central Valley in collaboration with state and federal agencies, water districts, non-profits, and landowners. Audubon is reviewing draft GSPs as a stakeholder for the environment with a particular focus on managed wetlands. We are commenting on draft GSPs to GSAs to improve their GSPs prior to the deadline to submit final GSPs to the Department of Water Resources in January 2022. Audubon would also like to identify areas of opportunity to partner with landowners and GSAs to provide groundwater and wildlife habitat benefits in the implementation of the Sustainable Groundwater Management Act (SGMA).

Over 90 percent of historic wetlands in the Central Valley have been replaced with agriculture or urban development. Disconnected from natural water sources as a consequence of surface water diversions and groundwater over-pumping, wetland landowners must utilize surface water deliveries or pump groundwater to provide flooded habitat. But managed wetlands provide outsized public trust benefits for their minor water use.

The remaining wetlands in the Central Valley are a critical component of the Pacific Flyway, supporting millions of migratory waterfowl, hundreds of thousands of shorebirds, and state listed species like the Tricolored Blackbird. Central Valley managed wetlands are part of California’s commitment to national and international Pacific Flyway agreements and provide significant public trust benefits, including habitat for migratory birds, recharge of overdrafted aquifers, carbon sequestration, and recreation opportunities for birders, hunters, and disadvantaged communities.

As recognized by the Sutter GSAs, managed wetlands require specific consideration in GSPs under SGMA statute and regulations, as detailed below. GSAs are required to identify managed wetlands as beneficial users of groundwater and as land uses and property interests and should recognize this land use consistent with other active users of surface and groundwater. The overall basin water budget must include managed wetlands as a specific water use sector and the GSP is required to consider the effects of the GSP on managed wetlands as a beneficial user or land use.

When GSPs fail to adequately consider the water needs and recharge contributions of managed wetlands, projects and management actions may ignore managed wetlands, their need for protection as public trust

resources, and their potential to be part of sustainability solutions. If future actions include groundwater allocations, managed wetlands face the potential of being excluded if not recognized in the GSP, risking further loss in critical wetland acreage.

SGMA Requirements Related to Managed Wetlands

A primary requirement for GSAs during GSP development is the consideration of the interests of “all beneficial uses and users of groundwater” [Water Code Section 10723.2], which includes “[e]nvironmental users of groundwater” [Water Code Section 10723.2(e)].

Articulated into the SGMA regulations, the concept of beneficial uses and users of groundwater is first represented in CCR, Title 23, Section 354.10. Notice and Communication, which directs the GSP to “...include a summary of information relating to notification and communication by the Agency with other agencies and interested parties including the following: (a) A description of the beneficial uses and users of groundwater in the basin, including the land uses and property interests potentially affected by the use of groundwater in the basin, the types of parties representing those interests, and the nature of consultation with those parties.” [emphasis added].

Furthermore, the SGMA regulations provide a definition that explicitly includes managed wetlands as a beneficial user where:

“‘Water use sector’ refers to categories of water demand based on the general land uses to which the water is applied, including urban, industrial, agricultural, managed wetlands, managed recharge, and native vegetation.” CCR, Title 23, Section 351(al) [emphasis added].

GSAs are then directed to include all water user sectors in the description of the GSP area and to quantify groundwater use by these sectors in the historic, current and projected budgets [emphasis added]:

CCR §354.8. Description of Plan Area: Each Plan shall include a description of the geographic areas covered, including the following information:

- (a) One or more maps of the basin that depict the following, as applicable:
 - (4) Existing land use designations and the identification of water use sector and water source type.

and,

CCR §354.18. Water Budget:

- (b) The water budget shall quantify the following, either through direct measurements or estimates based on data:
 - (3) Outflows from the groundwater system by water use sector, including evapotranspiration, groundwater extraction, groundwater discharge to surface water sources, and subsurface groundwater outflow.

Given these explicit requirements, GSAs are required to identify and map managed wetlands and include their water needs in water budgets in the GSP.

Furthermore, each GSP is also required to describe “undesirable results” where such included:

“Potential effects on the beneficial uses and users of groundwater, on land uses and property interests, and other potential effects that may occur or are occurring from undesirable results.”
 CCR, Title 23, Section 354.26(b)(3) [emphasis added]

Comment Overview

We applaud the Sutter GSAs for their proactive effort to include managed wetlands throughout the GSP. As a result, our comments are limited and summarized as follows:

- 1. Identification of managed wetlands: Audubon appreciates that the Sutter GSAs have identified and specifically included federal, state and privately managed wetlands in text, figures (e.g. Figure 2-4), and water budgets, especially Sutter National Wildlife Refuge (NWR) and the Butte Sink Wildlife Management Area (WMA). 21
- 2. Water budget: Audubon appreciates the specific inclusion of managed wetlands into the water budgets (e.g. Table 5-11 and Table 5-12), especially the inclusion of greater water use in the future budget resulting from anticipated delivery of Central Valley Project Improvement Act (CVPIA) Full Level 4 refuge water supplies to Sutter NWR. 22
- 3. Consideration of managed wetlands: Audubon appreciates that the listed projects included in Table 7-2 (GSP page 7-7) identified opportunities for multi-benefit projects that provide water supply and wildlife habitat benefits and sufficient project details were included in Section 7.1.4.4 (GSP page 7-44). 23

Draft Groundwater Sustainability Plan Page-by-Page Comments

Additional page-by-page comments on the Sutter GSAs’ draft GSP are detailed below. We welcome any follow up questions and look forward to seeing the issues raised below addressed in the final GSP submission in January 2022.

- Section 2.2, page 2-21: Suggest modifying the opening sentence in the second paragraph as follows: “*Surface water from the Feather and Sacramento Rivers and groundwater are the water sources used for irrigation, managed wetland, municipal and industrial, and urban/domestic purposes (Figure 2-13)*” 24
- Table 2-2, page 2-21: Suggest adding “including managed wetlands” as a parenthetical descriptor to “Riparian Vegetation” as often the former category includes explicit actions to apply water and manage food and habitat compared to riparian vegetation which often correlates to unmanaged stream course vegetation and habitats depending on a riparian water source. 25
- Figure 2-12, page 2-22: Same comment as described for Table 2-2. 26
- Figure 2-13, page 2-23: Suggest shading the Sutter NWR and Butte Sink WMA areas and including in the legend as “irrigated managed wetlands” to help demonstrate these lands actively apply water within these boundaries. 27
- Section 2.2.2, page 2-53: Suggest adding a subsection for “managed wetlands water supply” similar to the subsection for “urban water supply” and “agricultural water supply.” Because these land uses apply both surface and groundwater, with the Sutter NWR receiving supplies under congressional mandate (CVPIA refuge water supply program), it is important for the reader to see this user in similar context to agricultural and urban uses. 28

Table 5-10, page 5-189: This table should include a row for “managed wetlands demand” (similar to “agricultural demand” and “urban demand”) to help provide the basis for higher future water demands and surface supplies as infrastructure to adequately delivery CVPIA mandated water supplies to Sutter NWR is anticipated to be completed and CVPIA Full Level 4 water supplies to Sutter NWR are slated to begin more routinely.

29

Footnote 1, page 5-193: Please correct the spelling to read “Greg Young”

30

Section 5.3.5, page 5-194: Suggest adding “managed wetlands” for the surface water and groundwater bullets under “Inflow.”

31

Thank you for your consideration of Audubon California’s comments. If you would like to discuss this matter further, please do not hesitate to contact me at (916) 737-5707 or via email at samantha.arthur@audubon.org.

Sincerely,



Samantha Arthur
Working Lands Program Director
Audubon California



Sutter Subbasin <info@suttersubbasin.org>

Sutter Subbasin GSP Chapters 2, 3 & 4 Comments

1 message

Ben King <bking@pacgoldag.com>
 To: Sutter Subbasin <info@suttersubbasin.org>
 Cc: Ben King <bking@pacgoldag.com>

Thu, Nov 11, 2021 at 7:56 PM

Hi Leslie,

Here are my Comments on Chapters 2, 3 & 4 of the Draft GSP

1. Figure 2-7 The community of Meridian should be included. It is a longstanding community of north western Sutter County and includes an elementary school dependent on groundwater for water supply. 32
2. 2.1.3.2.3 Water Transfers out of basin and the mechanics of ground water substitution should be discussed and reference the data in Section 2.4 One of the 5 public comments in the draft Appendix expressed concern about groundwater transfers. There is currently litigation with settlement contractor plaintiffs concerning out of basin water transfers and groundwater substitution 33
3. 2.3.1.12 There should be discussion regarding the prioritization of subbasins in the implementation of CV Salts and how the Sutter Subbasin is not designated as a priority subbasin. 34
4. 2.4 Is it correct that substitution transfers are completed by agencies not using their full allotment of water? Is it not just a use of groundwater in lieu for the water transferred out of basin – the impact is that the Sutter Subbasin water budget allocated amount available is reduced by the amount of water transferred? 35
5. 2.5.10 If groundwater is pumped in the sphere of hydrological impact of groundwater substitution isn't it clear that there could be a negative impact on a GDE if water levels are lowered in a materially adverse way or if groundwater is degraded. There definitely are known concerns even though the impacts have not been studied. This needs to be addressed here or in Section 5.3. 36
6. 3.2.5, 3.2.6 & 3.2.7 – there are no websites included? How can Stakeholders know of public meetings or gain access to public information for these GSA's? 37
7. 4.1.1 - It should be noted that the HRTW was incorporated into the DWR Department Manual during April 2021 as noted in the recent DWR Drought Resolution. The pending SWRB resolution on Racial Equity should also be noted as a basis for the consideration of adverse racial outcomes due the implementation of the GSP for the Sutter Subbasin. The Sutter Subbasin is especially significant for Diversity, Equity and Inclusion issues because it has significant populations from the Mexican American, African American and Sikh communities. 38
8. 4.1 generally – there should be some discussion regarding outreach to the Spanish speaking and Punjabi speaking communities. The notices and communications in three different languages for the Sutter Subbasin should be highlighted. 39
9. 4.2.2 There were only 5 public comments included in the Appendix. As a Stakeholder, there was no public disclosure of public comments made during meetings or any comments received except for five responses to an early survey. This was a definite failure for Stakeholder Engagement since the public has no idea what other comments were submitted or expressed by other stakeholders during the GSP development. Many of the comments that I submitted were unacknowledged and I have no idea if any of the comments were considered in the draft GSP development. I also submitted a PMA which was also unacknowledged with no evidence that it was considered in the PMAs set forth in the Appendix. There are no publicly submitted PMAs in the Appendix and most of the PMAs set forth in the Appendix have no source submissions or backup information. The PMAs detailed in the Appendix relate to projects developed in 2014. 40



November 12, 2021

Sutter Subbasin Groundwater Management Coordination Committee

Submitted via email: info@suttersubbasin.org

Re: Public Comment Letter for Sutter Subbasin Draft GSP

Dear Guadalupe Rivera,

On behalf of the above-listed organizations, we appreciate the opportunity to comment on the Draft Groundwater Sustainability Plan (GSP) for the Sutter Subbasin being prepared under the Sustainable Groundwater Management Act (SGMA). Our organizations are deeply engaged in and committed to the successful implementation of SGMA because we understand that groundwater is critical for the resilience of California's water portfolio, particularly in light of changing climate. Under the requirements of SGMA, Groundwater Sustainability Agencies (GSAs) must consider the interests of all beneficial uses and users of groundwater, such as domestic well owners, environmental users, surface water users, federal government, California Native American tribes and disadvantaged communities (Water Code 10723.2).

As stakeholder representatives for beneficial users of groundwater, our GSP review focuses on how well disadvantaged communities, drinking water users, tribes, climate change, and the environment were addressed in the GSP. While we appreciate that some basins have consulted us directly via focus groups, workshops, and working groups, we are providing public comment letters to all GSAs as a means to engage in the development of 2022 GSPs across the state. Recognizing that GSPs are complicated and resource intensive to develop, the intention of this letter is to provide constructive stakeholder feedback that can improve the GSP prior to submission to the State.

Based on our review, we have significant concerns regarding the treatment of key beneficial users in the Draft GSP and consider the GSP to be **insufficient** under SGMA. We highlight the following findings:

1. Beneficial uses and users **are not sufficiently** considered in GSP development.
 - a. Human Right to Water considerations **are not sufficiently** incorporated.
 - b. Public trust resources **are not sufficiently** considered.
 - c. Impacts of Minimum Thresholds, Measurable Objectives and Undesirable Results on beneficial uses and users **are not sufficiently** analyzed.
2. Climate change **is not sufficiently** considered.
3. Data gaps **are not sufficiently** identified and the GSP **needs additional plans** to eliminate them.
4. Projects and Management Actions **sufficiently consider** potential impacts or benefits to beneficial uses and users.

Our specific comments related to the deficiencies of the Sutter Subbasin Draft GSP along with recommendations on how to reconcile them, are provided in detail in **Attachment A**.

Please refer to the enclosed list of attachments for additional technical recommendations:

- Attachment A** GSP Specific Comments
- Attachment B** SGMA Tools to address DAC, drinking water, and environmental beneficial uses and users
- Attachment C** Freshwater species located in the basin
- Attachment D** The Nature Conservancy's "Identifying GDEs under SGMA: Best Practices for using the NC Dataset"
- Attachment E** Maps of representative monitoring sites in relation to key beneficial users

Thank you for fully considering our comments as you finalize your GSP.

Best Regards,



Ngodoo Atume
Water Policy Analyst
Clean Water Action/Clean Water Fund



J. Pablo Ortiz-Partida, Ph.D.
Western States Climate and Water Scientist
Union of Concerned Scientists



Samantha Arthur
Working Lands Program Director
Audubon California



Danielle V. Dolan
Water Program Director
Local Government Commission



E.J. Remson
Senior Project Director, California Water Program
The Nature Conservancy



Melissa M. Rohde
Groundwater Scientist
The Nature Conservancy



Amy Merrill, Ph.D.
Acting Director, California Program
American Rivers



Kristan Culbert
Associate Director, California Central Valley River
Conservation
American Rivers

Attachment A

Specific Comments on the Sutter Subbasin Draft Groundwater Sustainability Plan

1. Consideration of Beneficial Uses and Users in GSP development

Consideration of beneficial uses and users in GSP development is contingent upon adequate identification and engagement of the appropriate stakeholders. The (A) identification, (B) engagement, and (C) consideration of disadvantaged communities, drinking water users, tribes,¹ groundwater dependent ecosystems, streams, wetlands, and freshwater species are essential for ensuring the GSP integrates existing state policies on the Human Right to Water and the Public Trust Doctrine.

A. Identification of Key Beneficial Uses and Users

Disadvantaged Communities, Drinking Water Users, and Tribes

The identification of Disadvantaged Communities (DACs) and drinking water users is **insufficient**. The GSP identifies and maps the locations of DACs and describes each DAC population within the subbasin. However, we note the following deficiencies with the identification of these key beneficial users:

- The GSP identifies tribal communities that may have cultural and traditional ties within the subbasin. However, the plan fails to map the locations of tribal lands or tribal interests in the subbasin.
- The GSP provides a map of domestic well density in Figure 2-9, but fails to provide depth of these wells (such as minimum well depth, average well depth, or depth range) within the subbasin. This information is necessary to understand the distribution of shallow and vulnerable drinking water wells within the basin.
- While the GSP identifies the population dependent on groundwater as their source of drinking water in the subbasin, specifics are not provided on how much each DAC community relies on a particular water supply (e.g., what percentage is supplied by groundwater).
- The GSP references CalEnviroScreen 3.0, but is not updated with the most recent CalEnviroScreen results from 4.0.

These missing elements are required for the GSAs to fully understand the specific interests and water demands of these beneficial users, and to support the consideration of beneficial users in the development of sustainable management criteria and selection of projects and management actions.

41

¹ Our letter provides a review of the identification and consideration of federally recognized tribes (Data source: SGMA Data viewer) within the GSP from non-tribal members and NGOs. Based on the likely incomplete information available to our organizations for this review, we recommend that the GSA utilize the California Department of Water Resources' "Engagement with Tribal Governments" Guidance Document (<https://water.ca.gov/Programs/Groundwater-Management/SGMA-Groundwater-Management/Best-Management-Practices-and-Guidance-Documents>) to comprehensively address these important beneficial users in their GSP.

RECOMMENDATIONS
<ul style="list-style-type: none"> • Provide a map of tribal lands and describe tribal interests in the subbasin. • Include a map showing domestic well locations and average well depth across the subbasin. • Identify the sources of drinking water for DAC members, including an estimate of how many people rely on groundwater (e.g., domestic wells, state small water systems, and public water systems). • Utilize the updated version 4.0 of CalEnviroScreen.

41

Interconnected Surface Waters

The identification of Interconnected Surface Waters (ISWs) is **incomplete**. Streamflow depletion in the Sutter Subbasin was evaluated using the C2VSimFG-Sutter model, an integrated hydrologic flow model for the subbasin. The model is described in Appendix 5-G (C2VSimFG-Sutter Model Report) and simulates the period from 1996 to 2015. Appendix 5-G describes the data used in the model, including the location and screening depths of groundwater wells and stream gauge data in the subbasin.

The GSP confirms the results of the ISW analysis with data from TNC’s Interconnected Surface Water in the Central Valley (ICONS) website, as presented on Figure 5-92 of the GSP.²

Stream nodes from the model were characterized as having gaining conditions, losing conditions, or mixed conditions (Figure 5-91). The GSP states: *“The C2VSimFG-Sutter model does not contain stream nodes in the Sutter Buttes foothills, and therefore the interaction between those streams and the underlying water table were not evaluated.”* We recommend that these stream reaches are retained as potential ISWs in the GSP until further data is gathered.

42

RECOMMENDATIONS
<ul style="list-style-type: none"> • To confirm the results of the groundwater modeling analysis and support conclusions about the Sutter Buttes foothills stream reaches, overlay the stream reaches shown with depth-to-groundwater contour maps to illustrate groundwater depths and the groundwater gradient near the stream reaches. For the depth-to-groundwater contour maps, use the best practices presented in Attachment D. Specifically, ensure that the first step is contouring groundwater elevations, and then subtracting this layer from land surface elevations from a Digital Elevation Model (DEM) to estimate depth-to-groundwater contours across the landscape. This will provide accurate contours of depth to groundwater along streams and other land surface depressions where GDEs are commonly found. • Describe data gaps for the ISW analysis in the ISW section, in addition to the discussion in Section 7.2.6.6.5 (Interconnected Surface Water Monitoring Network Data Gaps). While the GSP identifies data gaps and their locations in the text, we

²Available online at: <https://icons.codefornature.org/>

recommend that the GSP considers any segments with data gaps as potential ISWs and clearly marks them as such on maps provided in the GSP.

42

Groundwater Dependent Ecosystems

The identification of Groundwater Dependent Ecosystems (GDEs) is **insufficient**. The GSP took initial steps to identify and map GDEs using the Natural Communities Commonly Associated with Groundwater dataset (NC dataset). However, we found that some mapped features in the NC dataset were improperly disregarded. NC dataset polygons were incorrectly removed in areas adjacent to irrigated fields or adjacent to rivers and streams. However, this removal criteria is flawed since GDEs can rely on multiple water sources – including shallow groundwater receiving inputs from surface water flow or irrigation return flow from nearby irrigated fields – simultaneously and at different temporal/spatial scales. NC dataset polygons adjacent to irrigated land or surface water supplies can still potentially be reliant on shallow groundwater aquifers, and therefore should not be removed solely based on their proximity to these additional water sources.

The GSP identifies and maps GDEs in normal (2013), dry (2015), and wet (2017) years based on a 30-foot screening threshold; maps are presented in Figures 5-96, 5-97, and 5-98, respectively. However, no description or presentation of groundwater data (such as depth-to-groundwater contour maps) is provided. Furthermore, it is unclear which GDEs are retained as potential GDEs for the purposes of establishing monitoring and sustainable management criteria.

The GSP states (5-173): *“Oak trees are considered the deepest-rooted plant in the region with a root zone of roughly 25 to 30 feet.”* If Valley Oaks exist in the subbasin, we recommend instead that an 80-foot depth-to-groundwater threshold be used when inferring whether Valley Oak polygons in the NC dataset are likely reliant on groundwater. This recommendation is based on a recent correction in TNC’s rooting depth database,³ after finding a typo in the max rooting depth units for Valley Oak. This resulted in a specific change in the max rooting depth of Valley Oak from 24 feet to 24 meters (80 feet). For all other phreatophytes, we continue to recommend that a 30-foot depth-to-groundwater threshold be used when inferring whether all other NC dataset polygons are likely reliant on groundwater.

43

RECOMMENDATIONS

- Re-evaluate the NC dataset polygons that are adjacent to irrigated fields or streams and rivers. Refer to Attachment D of this letter for best practices for using local groundwater data to verify whether polygons in the NC Dataset are supported by groundwater in an aquifer.
- Use depth-to-groundwater data from multiple seasons and water year types (e.g., wet, dry, average, drought) to determine the range of depth to groundwater around NC dataset polygons. We recommend that a baseline period (10 years from 2005 to 2015) be established to characterize groundwater conditions over multiple water year types.
- Provide depth-to-groundwater contour maps, noting the best practices presented in Attachment D. Specifically, ensure that the first step is contouring groundwater

³ TNC. 2021. Plant Rooting Depth Database. Available at: <https://groundwaterresourcehub.org/sgma-tools/gde-rooting-depths-database-for-gdes/>

elevations, and then subtracting this layer from land surface elevations from a DEM to estimate depth-to-groundwater contours across the landscape.

- Refer to Attachment B for more information on TNC’s plant rooting depth database. Deeper thresholds are necessary for plants that have reported maximum root depths that exceed the averaged 30-ft threshold, such as Valley Oak (*Quercus lobata*). We recommend that the reported max rooting depth for these deeper-rooted plants be used. For example, a depth-to-groundwater threshold of 80 feet should be used instead of the 30-ft threshold, when verifying whether Valley Oak polygons from the NC Dataset are connected to groundwater. It is important to emphasize that actual rooting depth data are limited and will depend on the plant species and site-specific conditions such as soil and aquifer types, and proximity to other water sources.
- If insufficient data are available to describe groundwater conditions within or near polygons from the NC dataset, include those polygons as “Potential GDEs” in the GSP until data gaps are reconciled in the monitoring network.

43

Native Vegetation and Managed Wetlands

Native vegetation and managed wetlands are water use sectors that are required to be included in the water budget.^{4,5} The integration of these ecosystems into the water budget is **sufficient** because the GSP includes the groundwater demands of native vegetation and managed wetlands as separate line items in the historical, current, and projected water budgets.

44

B. Engaging Stakeholders

Stakeholder Engagement During GSP Development

Stakeholder engagement during GSP development is **insufficient**. SGMA’s requirement for public notice and engagement of stakeholders is not fully met by the description in the Outreach and Communication chapter of the GSP (Chapter 4).⁶

We note the following deficiencies with the overall stakeholder engagement process:

- The GSP documents opportunities for public involvement and engagement in general terms. Public outreach and engagement activities include quarterly public workshops, public meetings, updates at GSA board and city council meetings, updates to the project website, email notices, social media postings, press releases and mailings, utility bill notifications, supporting materials provided in English, Spanish, and Punjabi, and online surveys for stakeholder feedback and input. There are no details of outreach and engagement specifically targeted to DACs, drinking water users, tribes, and environmental stakeholders during the GSP development process.

45

⁴ “Water use sector’ refers to categories of water demand based on the general land uses to which the water is applied, including urban, industrial, agricultural, managed wetlands, managed recharge, and native vegetation.” [23 CCR §351(a)]

⁵ “The water budget shall quantify the following, either through direct measurements or estimates based on data: (3) Outflows from the groundwater system by water use sector, including evapotranspiration, groundwater extraction, groundwater discharge to surface water sources, and subsurface groundwater outflow.” [23 CCR §354.18]

⁶ “A communication section of the Plan shall include a requirement that the GSP identify how it encourages the active involvement of diverse social, cultural, and economic elements of the population within the basin.” [23 CCR §354.10(d)(3)]

- Aside from the continuation of engagement strategies used during the GSP development process, the GSP does not include a detailed plan for continual opportunities for engagement through the *implementation* phase of the GSP that is specifically directed to DACs, drinking water users, tribes, and environmental stakeholders.

RECOMMENDATIONS
<ul style="list-style-type: none"> • In the Outreach and Communication chapter, describe active and targeted outreach to engage DACs, drinking water users, tribes, and environmental stakeholders throughout the GSP development and implementation phases. Refer to Attachment B for specific recommendations on how to actively engage stakeholders during all phases of the GSP process. • Utilize DWR's tribal engagement guidance to comprehensively address all tribes and tribal interests in the subbasin within the GSP.⁷

45

C. Considering Beneficial Uses and Users When Establishing Sustainable Management Criteria and Analyzing Impacts on Beneficial Uses and Users

The consideration of beneficial uses and users when establishing sustainable management criteria (SMC) is **insufficient**. The consideration of potential impacts on all beneficial users of groundwater in the basin are required when defining undesirable results and establishing minimum thresholds.^{8,9,10}

Disadvantaged Communities and Drinking Water Users

For chronic lowering of groundwater levels, the GSP states (p. 6-11): *“The minimum threshold for chronic lowering of groundwater levels is established as the deepest of the following: The historic low for the available record at each representative monitoring site; or 2. 90% of the average groundwater elevation from the projected water budget (baseline condition over 60-year period using C2VSimFG-Sutter) at each representative monitoring site with an artificial increase in evapotranspiration (ET) of 50%; or 3. The average operating range (difference between measurable objective and minimum threshold) for all representative monitoring sites using the above criteria for the following aquifer zones (AZs), applied based on the available screen interval or well depth information for each representative monitoring site: a. Shallow AZ and AZ-1 = 8.0 feet b. AZ-2 and AZ-3 = 16.5 feet.”*

46

The GSP states (6-17): *“The average operating range for the Shallow AZ and AZ-1 were combined with the goal of being protective of interconnected surface waters, GDEs, and*

⁷ Engagement with Tribal Governments Guidance Document. Available at: https://water.ca.gov/-/media/DWR-Website/Web-Pages/Programs/Groundwater-Management/Sustainable-Groundwater-Management/Best-Management-Practices-and-Guidance-Documents/Files/Guidance-Doc-for-SGM-Engagement-with-Tribal-Govt_ay_19.pdf

⁸ “The description of undesirable results shall include [...] potential effects on the beneficial uses and users of groundwater, on land uses and property interests, and other potential effects that may occur or are occurring from undesirable results.” [23 CCR §354.26(b)(3)]

⁹ “The description of minimum thresholds shall include [...] how minimum thresholds may affect the interests of beneficial uses and users of groundwater or land uses and property interests.” [23 CCR §354.28(b)(4)]

¹⁰ “The description of minimum thresholds shall include [...] how state, federal, or local standards relate to the relevant sustainability indicator. If the minimum threshold differs from other regulatory standards, the agency shall explain the nature of and the basis for the difference.” [23 CCR §354.28(b)(5)]

shallow domestic wells.” The text continues (p. 6-17): *“A minimum operating range is applied where applicable in order to allow for a reasonable use of groundwater by all beneficial users in the Sutter Subbasin.”* However, no analysis is presented that describes the impact of minimum thresholds on domestic well users. The GSP does not sufficiently describe whether minimum thresholds will avoid significant and unreasonable loss of drinking water to domestic well users, and whether the undesirable results are consistent with the Human Right to Water policy.¹¹ In addition, the GSP does not sufficiently describe or analyze direct or indirect impacts on DACs or tribes when defining undesirable results, nor does it describe how the groundwater levels minimum thresholds are consistent with Human Right to Water policy and will avoid significant and unreasonable impacts on these beneficial users.

For degraded water quality, SMC are established for total dissolved solids (TDS) and nitrate. The GSP states (p. 6-24): *“The minimum threshold for degraded water quality is established as the highest of: (1) the Upper SMCL for TDS (1,000 mg/L) and Primary MCL for nitrate as N (10 mg/L) or (2) current water quality conditions for TDS and nitrate as N based on data available from 2000 to the time of GSP development (Summer 2021) at the representative monitoring well or nearby well within the same aquifer zone, as described in Section 5.2.5 of the Basin Setting chapter, using maximum concentration detected of each constituent.”* However, according to the state’s anti-degradation policy,¹² high water quality should be protected and is only allowed to worsen if a finding is made that it is in the best interest of the people of the State of California. No analysis has been done and no such finding has been made.

Section 5.1.9 of the GSP (Water Quality) discusses water quality trends for several other constituents, including arsenic, boron, iron, manganese, and point-source contaminants. No SMC have been established for these additional constituents, however. SMC should be established for all COCs in the subbasin impacted or exacerbated by groundwater use and/or management, in addition to coordinating with water quality regulatory programs.

The GSP only includes a very general discussion of impacts on drinking water users when defining undesirable results and evaluating the impacts of proposed minimum thresholds. The GSP does not, however, mention or discuss direct and indirect impacts on DACs or tribes when defining undesirable results for degraded water quality, nor does it evaluate the cumulative or indirect impacts of proposed minimum thresholds on these beneficial users.

46

RECOMMENDATIONS
<p>Chronic Lowering of Groundwater Levels</p> <ul style="list-style-type: none"> ● Describe direct and indirect impacts on drinking water users, DACs, and tribes when describing undesirable results and defining minimum thresholds for chronic lowering of groundwater levels. ● Consider and evaluate the impacts of selected minimum thresholds and measurable objectives on drinking water users, DACs, and tribes within the subbasin. Further describe the impact of passing the minimum threshold for these users. For example, provide the number of domestic wells that would be fully or partially de-watered at the minimum threshold.

¹¹ California Water Code §106.3. Available at: https://leginfo.ca.gov/faces/codes_displaySection.xhtml?lawCode=WAT§ionNum=106.3

¹² Anti-degradation Policy. Available at: https://www.waterboards.ca.gov/board_decisions/adopted_orders/resolutions/1968/rs68_016.pdf

Degraded Water Quality

- Describe direct and indirect impacts on drinking water users, DACs, and tribes when defining undesirable results for degraded water quality.¹³ For specific guidance on how to consider these users, refer to “Guide to Protecting Water Quality Under the Sustainable Groundwater Management Act.”¹⁴
- Evaluate the cumulative or indirect impacts of proposed minimum thresholds for degraded water quality on drinking water users, DACs, and tribes.
- For TDS and nitrate, provide a summary table that presents the pre-2015 historical maximums, the objectives from the Basin Plan, the MCLs, and the resulting minimum thresholds. Ensure that the minimum thresholds do not exceed the objectives in the Basin Plan.
- Set minimum thresholds and measurable objectives for all water quality constituents within the subbasin that can be impacted and/or exacerbated as a result of groundwater use or groundwater management.
- Set minimum thresholds that do not allow water quality to degrade to levels at or above the MCL trigger level.

46

Groundwater Dependent Ecosystems and Interconnected Surface Waters

For chronic lowering of groundwater levels, minimum thresholds are established in the same manner as stated above under Disadvantaged Communities and Drinking Water Users (i.e., established as the deeper of three values). The result is that minimum thresholds allow groundwater levels to drop to, or below, historic lows in the subbasin. To describe effects on environmental beneficial uses and users, the GSP states (p. 6-22): “*Environmental users of groundwater typically rely on shallow groundwater (within 50 feet of ground surface or less) for recharge to interconnected streams and access by GDEs. If minimum thresholds for chronic lowering of groundwater levels are exceeded (even if an undesirable result is not observed), reduced groundwater recharge to streams and groundwater levels too deep for GDE species to access may be observed.*” The true impacts to ecosystems under this scenario are not fully discussed in the GSP. By assuming that GDEs can be sustained on historic low groundwater levels (or lower) and the subbasin is allowed to operate at or close to those levels over many years, there is a risk of causing catastrophic damage to ecosystems that is more adverse than what was occurring at the height of the 2012-2016 drought. While many California ecosystems are drought-adapted and therefore able to accommodate short-term water stress, prolonged drought conditions could cause adverse impacts, such as widespread tree mortality or loss of critical habitat for aquatic species, that are more severe than pre-2015 drought impacts.

47

For depletion of interconnected surface water, groundwater elevations are used as proxy for establishing SMC. As for chronic lowering of groundwater levels, minimum thresholds are again established in the same manner as stated above under Disadvantaged Communities and Drinking Water Users (i.e., established as the deeper of three values). To describe effects on

¹³ “Degraded Water Quality [...] collect sufficient spatial and temporal data from each applicable principal aquifer to determine groundwater quality trends for water quality indicators, as determined by the Agency, to address known water quality issues.” [23 CCR §354.34(c)(4)]

¹⁴ Guide to Protecting Water Quality under the Sustainable Groundwater Management Act https://d3n8a8pro7vnm.cloudfront.net/communitywatercenter/pages/293/attachments/original/1559328858/Guide_to_Protecting_Drinking_Water_Quality_Under_the_Sustainable_Groundwater_Management_Act.pdf?1559328858.

environmental beneficial uses and users, the GSP states (p. 6-46): *“If an undesirable result for depletions of interconnected surface water is observed and presently gaining streams become losing streams, this reversal of stream interconnection would affect aquatic systems and potentially GDEs. Overall water supply utilized by environmental beneficial users of water would be reduced, thereby reducing suitable habitat through reduced stream depth, flow velocity, cover, and dissolved oxygen as well as increased temperature.”* However, no analysis or discussion is presented to describe how the SMC will affect beneficial users, and more specifically GDEs, or the impact of these minimum thresholds on GDEs in the subbasin. Furthermore, the GSP makes no attempt to evaluate how the proposed minimum thresholds and measurable objectives avoid significant and unreasonable effects on surface water beneficial users in the subbasin (see Attachment C for a list of environmental users in the subbasin), such as increased mortality and inability to perform key life processes (e.g., reproduction, migration).

RECOMMENDATIONS

- When defining undesirable results for chronic lowering of groundwater levels, provide specifics on what biological responses (e.g., extent of habitat, growth, recruitment rates) would best characterize a significant and unreasonable impact to GDEs. Undesirable results to environmental users occur when ‘significant and unreasonable’ effects on beneficial users are caused by one of the sustainability indicators (i.e., chronic lowering of groundwater levels, degraded water quality, or depletion of interconnected surface water). Thus, potential impacts on environmental beneficial uses and users need to be considered when defining undesirable results in the subbasin.¹⁵ Defining undesirable results is the crucial first step before the minimum thresholds can be determined.¹⁶
- When defining undesirable results for depletion of interconnected surface water, include a description of potential impacts on instream habitats within ISWs when minimum thresholds in the subbasin are reached.¹⁷ The GSP should confirm that minimum thresholds for ISWs avoid adverse impacts to environmental beneficial users of interconnected surface waters as these environmental users could be left unprotected by the GSP. These recommendations apply especially to environmental beneficial users that are already protected under pre-existing state or federal law.^{6,18}
- When establishing SMC for the subbasin, consider that the SGMA statute [Water Code §10727.4(l)] specifically calls out that GSPs shall include “impacts on groundwater dependent ecosystems”.

47

¹⁵ “The description of undesirable results shall include [...] potential effects on the beneficial uses and users of groundwater, on land uses and property interests, and other potential effects that may occur or are occurring from undesirable results”. [23 CCR §354.26(b)(3)]

¹⁶ The description of minimum thresholds shall include [...] how minimum thresholds may affect the interests of beneficial uses and users of groundwater or land uses and property interests.” [23 CCR §354.28(b)(4)]

¹⁷ “The minimum threshold for depletions of interconnected surface water shall be the rate or volume of surface water depletions caused by groundwater use that has adverse impacts on beneficial uses of the surface water and may lead to undesirable results.” [23 CCR §354.28(c)(6)]

¹⁸ Rohde MM, Seapy B, Rogers R, Castañeda X, editors. 2019. Critical Species LookBook: A compendium of California’s threatened and endangered species for sustainable groundwater management. The Nature Conservancy, San Francisco, California. Available at: https://groundwaterresourcehub.org/public/uploads/pdfs/Critical_Species_LookBook_91819.pdf

2. Climate Change

The SGMA statute identifies climate change as a significant threat to groundwater resources and one that must be examined and incorporated in the GSPs. The GSP Regulations require integration of climate change into the projected water budget to ensure that projects and management actions sufficiently account for the range of potential climate futures.¹⁹ The effects of climate change will intensify the impacts of water stress on GDEs, making available shallow groundwater resources especially critical to their survival. Condon *et al.* (2020) shows that GDEs are more likely to succumb to water stress and rely more on groundwater during times of drought.²⁰ When shallow groundwater is unavailable, riparian forests can die off and key life processes (e.g., migration and spawning) for aquatic organisms, such as steelhead, can be impeded.

The integration of climate change into the projected water budget is **insufficient**. The GSP incorporates climate change into the projected water budget using DWR change factors for 2070. The plan reports some calculations in the Appendix for an Extremely Dry scenario to stress the system but does not seem to report and compare such results outside the Appendix. The GSP would benefit from clearly and transparently incorporating the extremely wet and dry scenarios provided by DWR into projected water budgets or select more appropriate extreme scenarios for the subbasin. While these extreme scenarios may have a lower likelihood of occurring, their consequences could be significant and their inclusion can help identify important vulnerabilities in the subbasin's approach to groundwater management.

The GSP integrates climate change into key inputs (e.g., changes in precipitation and evapotranspiration) of the projected water budget. However, imported water should also be adjusted for climate change and incorporated into the surface water flow inputs of the projected water budget. The sustainable yield is calculated based on the projected water budget with climate change incorporated. However, if the water budgets are incomplete, including the omission of extreme climate scenarios and the omission of projected climate change effects on imported water inputs, then there is increased uncertainty in virtually every subsequent calculation used to plan for projects, derive measurable objectives, and set minimum thresholds. Plans that do not adequately include climate change projections may underestimate future impacts on vulnerable beneficial users of groundwater such as ecosystems, DACs, tribes, and domestic well owners.

48

RECOMMENDATIONS
<ul style="list-style-type: none"> ● Integrate climate change, including extreme climate scenarios, into all elements of the projected water budget to form the basis for development of sustainable management criteria and projects and management actions. ● Incorporate climate change into surface water flow inputs, including imported water, for the projected water budget. ● Incorporate climate change scenarios into projects and management actions.

¹⁹ “Each Plan shall rely on the best available information and best available science to quantify the water budget for the basin in order to provide an understanding of historical and projected hydrology, water demand, water supply, land use, population, climate change, sea level rise, groundwater and surface water interaction, and subsurface groundwater flow.” [23 CCR §354.18(e)]

²⁰ Condon *et al.* 2020. Evapotranspiration depletes groundwater under warming over the contiguous United States. *Nature Communications*. Available at: <https://www.nature.com/articles/s41467-020-14688-0>

3. Data Gaps

The consideration of beneficial users when establishing monitoring networks is **insufficient**, due to lack of specific plans to increase the Representative Monitoring Wells (RMWs) in the monitoring network that represent water quality conditions and shallow groundwater elevations around DACs and domestic wells in the subbasin. These beneficial users may remain unprotected by the GSP without adequate monitoring and identification of data gaps in the shallow aquifer. The Plan therefore fails to meet SGMA's requirements for the monitoring network.²¹

Figure 7-2 (Groundwater Level Monitoring Network Wells, Shallow AZ) shows insufficient representation of DACs and drinking water users for shallow groundwater elevation monitoring. Figure 7-7 (Groundwater Quality Monitoring Network Wells, Shallow AZ) shows insufficient representation of DACs and drinking water users for shallow water quality monitoring. Refer to Attachment E for maps of these monitoring sites in relation to key beneficial users of groundwater.

RECOMMENDATIONS
<ul style="list-style-type: none"> ● Provide maps that overlay current and proposed monitoring well locations with the locations of DACs, domestic wells, and GDEs to clearly identify monitored areas. ● Increase the number of RMWs in the shallow aquifer across the subbasin as needed to map ISWs and adequately monitor all groundwater condition indicators across the subbasin and at appropriate depths for <i>all</i> beneficial users. Prioritize proximity to DACs, domestic wells, GDEs, and ISWs when identifying new RMWs. ● Ensure groundwater elevation and water quality RMWs are monitoring groundwater conditions spatially and at the correct depth for <i>all</i> beneficial users - especially DACs, domestic wells, and GDEs. ● Provide further details for the biological monitoring (described in the Projects and Management Actions section of the GSP) that can be used to assess the potential for significant and unreasonable impacts to GDEs or ISWs due to groundwater conditions in the subbasin.

49

4. Addressing Beneficial Users in Projects and Management Actions

The consideration of beneficial users when developing projects and management actions is **sufficient** due to the plan's clear identification of the benefits and impacts of projects and management actions, including water quality impacts, to key beneficial users of groundwater such as GDEs and DACs.

We commend the GSAs for describing the environmental benefits of the on-farm groundwater recharge program in the Sutter Subbasin, as developed with support and guidelines from The Nature Conservancy (TNC). The program is based on the TNC's multi-benefit recharge program.

50

²¹ "The monitoring network objectives shall be implemented to accomplish the following: [...] (2) Monitor impacts to the beneficial uses or users of groundwater." [23 CCR §354.34(b)(2)]

Because the GSP fails to clearly analyze impacts to domestic wells and DACs due to chronic lowering of groundwater levels, we recommend inclusion of a drinking water well impact mitigation program to proactively monitor and protect drinking water wells through GSP implementation.

RECOMMENDATIONS

- For DACs and domestic well owners, include a drinking water well impact mitigation program to proactively monitor and protect drinking water wells through GSP implementation. Refer to Attachment B for specific recommendations on how to implement a drinking water well mitigation program.
- Develop management actions that incorporate climate and water delivery uncertainties to address future water demand and prevent future undesirable results.

50

Attachment B

SGMA Tools to address DAC, drinking water, and environmental beneficial uses and users

Stakeholder Engagement and Outreach

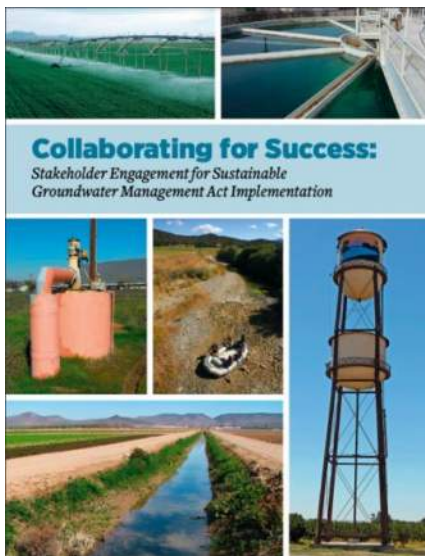

Clean Water Action, Community Water Center and Union of Concerned Scientists developed a guidance document called [Collaborating for success: Stakeholder engagement for Sustainable Groundwater Management Act Implementation](#). It provides details on how to conduct targeted and broad outreach and engagement during Groundwater Sustainability Plan (GSP) development and implementation. Conducting a targeted outreach involves:

- Developing a robust Stakeholder Communication and Engagement plan that includes outreach at frequented locations (schools, farmers markets, religious settings, events) across the plan area to increase the involvement and participation of disadvantaged communities, drinking water users and the environmental stakeholders.
- Providing translation services during meetings and technical assistance to enable easy participation for non-English speaking stakeholders.
- GSP should adequately describe the process for requesting input from beneficial users and provide details on how input is incorporated into the GSP.

The Human Right to Water

Human Right To Water Scorecard for the Review of Groundwater Sustainability Plans

Review Criteria <i>(All Indicators Must be Present in Order to Protect the Human Right to Water)</i>		Yes/No
A Plan Area		
1	Does the GSP identify, describe, and provide maps of all of the following beneficial users in the GSA area? ²⁷ <ul style="list-style-type: none"> a. Disadvantaged Communities (DACs) b. Tribes c. Community water systems d. Private well communities 	
2	Land use policies and practices ²⁸ Does the GSP review all relevant policies and practices of land use agencies which could impact groundwater resources? These include but are not limited to the following: <ul style="list-style-type: none"> a. Water use policies General Plans and local land use and water planning documents b. Plans for development and zoning c. Processes for permitting activities which will increase water consumption 	
B Basin Setting (Groundwater Conditions and Water Budget)		
1	Does the groundwater level conditions section include past and current drinking water supply issues of domestic well users, small community water systems, state small water systems, and disadvantaged communities? ²⁹	
2	Does the groundwater quality conditions section include past and current drinking water quality issues of domestic well users, small community water systems, state small water systems, and disadvantaged communities, including public water wells that had or have MCLs exceedances? ³⁰	
3	Does the groundwater quality conditions section include a review of all commitments with primary drinking water standards known to exist in the GSP area, as well as hexavalent chromium, and PFOS/PFOAs? ³¹	
4	Incorporating drinking water needs into the water budget ³² Does the Future Projected Water Budget section explicitly include both the current and projected future drinking water needs of communities on domestic wells and community water systems (including but not limited to infill development and communities' plans for infill development,	

The [Human Right to Water Scorecard](#) was developed by Community Water Center, Leadership Counsel for Justice and Accountability and Self Help Enterprises to aid Groundwater Sustainability Agencies (GSAs) in prioritizing drinking water needs in SGMA. The scorecard identifies elements that must exist in GSPs to adequately protect the Human Right to Drinking water.

Drinking Water Well Impact Mitigation Framework

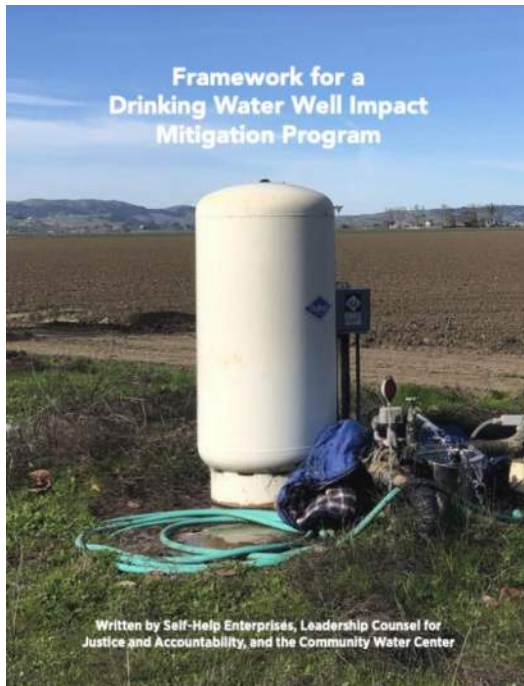

The [Drinking Water Well Impact Mitigation Framework](#) was developed by Community Water Center, Leadership Counsel for Justice and Accountability and Self Help Enterprises to aid GSAs in the development and implementation of their GSPs. The framework provides a clear roadmap for how a GSA can best structure its data gathering, monitoring network and management actions to proactively monitor and protect drinking water wells and mitigate impacts should they occur.

Groundwater Resource Hub

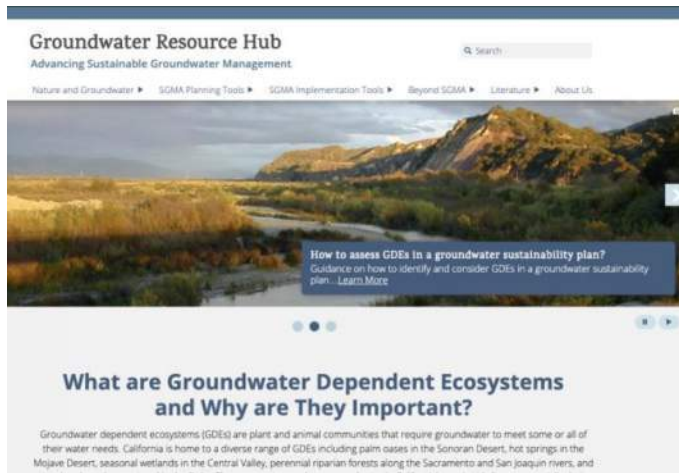

The Nature Conservancy has developed a suite of tools based on best available science to help GSAs, consultants, and stakeholders efficiently incorporate nature into GSPs. These tools and resources are available online at GroundwaterResourceHub.org. The Nature Conservancy's tools and resources are intended to reduce costs, shorten timelines, and increase benefits for both people and nature.

Rooting Depth Database

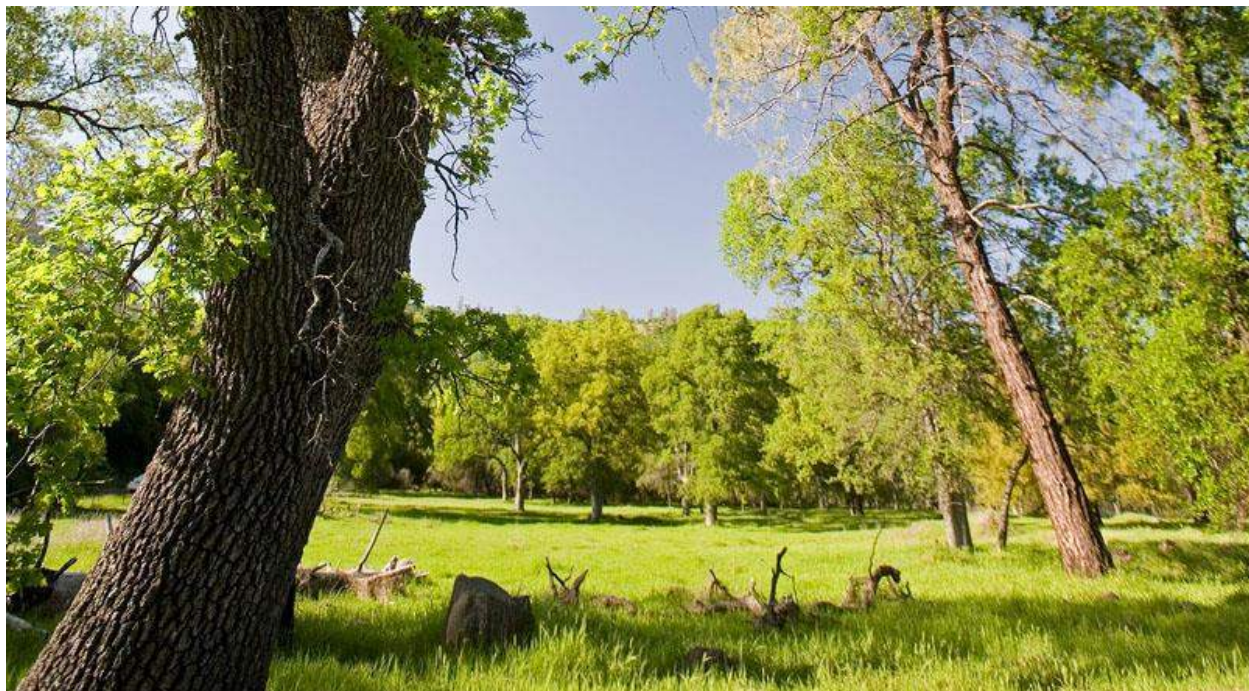

The [Plant Rooting Depth Database](#) provides information that can help assess whether groundwater-dependent vegetation are accessing groundwater. Actual rooting depths will depend on the plant species and site-specific conditions, such as soil type and

availability of other water sources. Site-specific knowledge of depth to groundwater combined with rooting depths will help provide an understanding of the potential groundwater levels are needed to sustain GDEs.

How to use the database

The maximum rooting depth information in the Plant Rooting Depth Database is useful when verifying whether vegetation in the Natural Communities Commonly Associated with Groundwater ([NC Dataset](#)) are connected to groundwater. A 30 ft depth-to-groundwater threshold, which is based on averaged global rooting depth data for phreatophytes¹, is relevant for most plants identified in the NC Dataset since most plants have a max rooting depth of less than 30 feet. However, it is important to note that deeper thresholds are necessary for other plants that have reported maximum root depths that exceed the averaged 30 feet threshold, such as valley oak (*Quercus lobata*), Euphrates poplar (*Populus euphratica*), salt cedar (*Tamarix spp.*), and shadescale (*Atriplex confertifolia*). The Nature Conservancy advises that the reported max rooting depth for these deeper-rooted plants be used. For example, a depth-to-groundwater threshold of 80 feet should be used instead of the 30 ft threshold, when verifying whether valley oak polygons from the NC Dataset are connected to groundwater. It is important to re-emphasize that actual rooting depth data are limited and will depend on the plant species and site-specific conditions such as soil and aquifer types, and availability to other water sources.

The Plant Rooting Depth Database is an Excel workbook composed of four worksheets:

1. California phreatophyte rooting depth data (included in the NC Dataset)
2. Global phreatophyte rooting depth data
3. Metadata
4. References

How the database was compiled

The Plant Rooting Depth Database is a compilation of rooting depth information for the groundwater-dependent plant species identified in the NC Dataset. Rooting depth data were compiled from published scientific literature and expert opinion through a crowdsourcing campaign. As more information becomes available, the database of rooting depths will be updated. Please [Contact Us](#) if you have additional rooting depth data for California phreatophytes.

¹ Canadell, J., Jackson, R.B., Ehleringer, J.B. et al. 1996. Maximum rooting depth of vegetation types at the global scale. *Oecologia* 108, 583–595. <https://doi.org/10.1007/BF00329030>

GDE Pulse

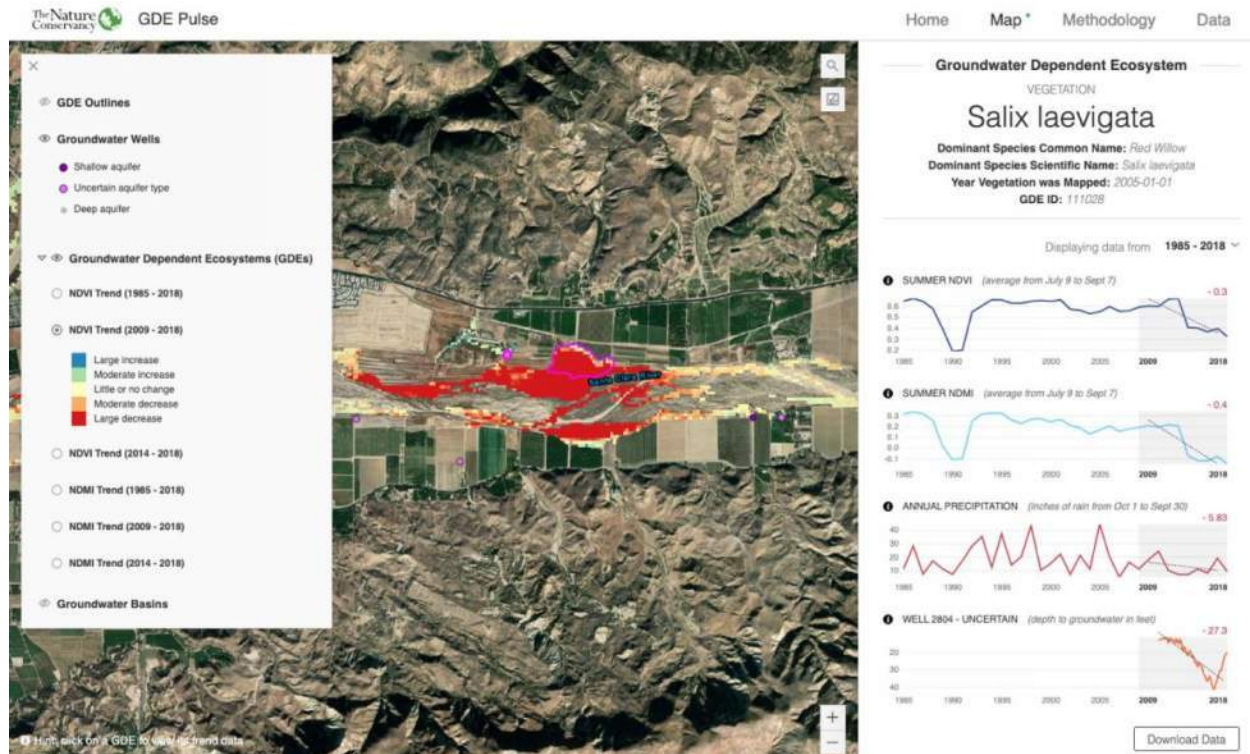

[GDE Pulse](#) is a free online tool that allows Groundwater Sustainability Agencies to assess changes in groundwater dependent ecosystem (GDE) health using satellite, rainfall, and groundwater data. Remote sensing data from satellites has been used to monitor the health of vegetation all over the planet. GDE pulse has compiled 35 years of satellite imagery from NASA's Landsat mission for every polygon in the Natural Communities Commonly Associated with Groundwater Dataset. The following datasets are available for downloading:

Normalized Difference Vegetation Index (NDVI) is a satellite-derived index that represents the greenness of vegetation. Healthy green vegetation tends to have a higher NDVI, while dead leaves have a lower NDVI. We calculated the average NDVI during the driest part of the year (July - Sept) to estimate vegetation health when the plants are most likely dependent on groundwater.

Normalized Difference Moisture Index (NDMI) is a satellite-derived index that represents water content in vegetation. NDMI is derived from the Near-Infrared (NIR) and Short-Wave Infrared (SWIR) channels. Vegetation with adequate access to water tends to have higher NDMI, while vegetation that is water stressed tends to have lower NDMI. We calculated the average NDVI during the driest part of the year (July–September) to estimate vegetation health when the plants are most likely dependent on groundwater.

Annual Precipitation is the total precipitation for the water year (October 1st – September 30th) from the PRISM dataset. The amount of local precipitation can affect vegetation with more precipitation generally leading to higher NDVI and NDMI.

Depth to Groundwater measurements provide an indication of the groundwater levels and changes over time for the surrounding area. We used groundwater well measurements from nearby (<1km) wells to estimate the depth to groundwater below the GDE based on the average elevation of the GDE (using a digital elevation model) minus the measured groundwater surface elevation.

ICONOS Mapper

Interconnected Surface Water in the Central Valley

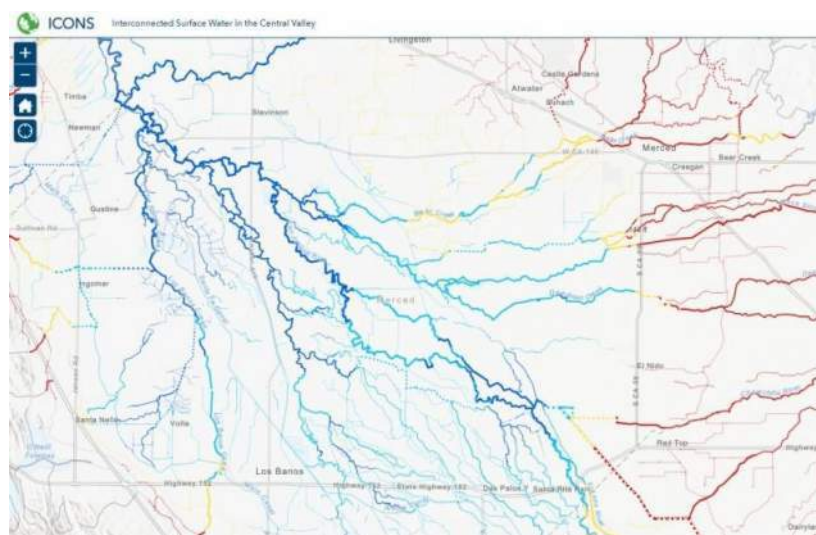

ICONOS maps the likely presence of interconnected surface water (ISW) in the Central Valley using depth to groundwater data. Using data from 2011-2018, the ISW dataset represents the likely connection between surface water and groundwater for rivers and streams in California's Central Valley. It includes information on the mean, maximum, and minimum depth to groundwater for each stream segment over the years with available data, as well as the likely presence of ISW based on the minimum depth to groundwater. The Nature Conservancy developed this database, with guidance and input from expert academics, consultants, and state agencies.

We developed this dataset using groundwater elevation data [available online](#) from the California Department of Water Resources (DWR). DWR only provides this data for the Central Valley. For GSAs outside of the valley, who have groundwater well measurements, we recommend following our methods to determine likely ISW in your region. The Nature Conservancy's ISW dataset should be used as a first step in reviewing ISW and should be supplemented with local or more recent groundwater depth data.

Attachment C

Freshwater Species Located in the Sutter Basin

To assist in identifying the beneficial users of surface water necessary to assess the undesirable result “depletion of interconnected surface waters”, Attachment C provides a list of freshwater species located in the Sutter Basin. To produce the freshwater species list, we used ArcGIS to select features within the California Freshwater Species Database version 2.0.9 within the basin boundary. This database contains information on ~4,000 vertebrates, macroinvertebrates and vascular plants that depend on fresh water for at least one stage of their life cycle. The methods used to compile the California Freshwater Species Database can be found in Howard et al. 2015¹. The spatial database contains locality observations and/or distribution information from ~400 data sources. The database is housed in the California Department of Fish and Wildlife’s BIOS² as well as on The Nature Conservancy’s science website³.

Scientific Name	Common Name	Legal Protected Status		
		Federal	State	Other
BIRDS				
<i>Coccyzus americanus occidentalis</i>	Western Yellow-billed Cuckoo	Candidate - Threatened	Endangered	
<i>Laterallus jamaicensis coturniculus</i>	California Black Rail	Bird of Conservation Concern	Threatened	
<i>Riparia riparia</i>	Bank Swallow		Threatened	
<i>Actitis macularius</i>	Spotted Sandpiper			
<i>Aechmophorus clarkii</i>	Clark's Grebe			
<i>Aechmophorus occidentalis</i>	Western Grebe			
<i>Agelaius tricolor</i>	Tricolored Blackbird	Bird of Conservation Concern	Special Concern	BSSC - First priority
<i>Aix sponsa</i>	Wood Duck			
<i>Anas acuta</i>	Northern Pintail			
<i>Anas americana</i>	American Wigeon			
<i>Anas clypeata</i>	Northern Shoveler			
<i>Anas crecca</i>	Green-winged Teal			

¹ Howard, J.K. et al. 2015. Patterns of Freshwater Species Richness, Endemism, and Vulnerability in California. PLoS ONE, 11(7). Available at: <https://journals.plos.org/plosone/article?id=10.1371/journal.pone.0130710>

² California Department of Fish and Wildlife BIOS: <https://www.wildlife.ca.gov/data/BIOS>

³ Science for Conservation: <https://www.scienceforconservation.org/products/california-freshwater-species-database>

Anas cyanoptera	Cinnamon Teal			
Anas discors	Blue-winged Teal			
Anas platyrhynchos	Mallard			
Anas strepera	Gadwall			
Anser albifrons	Greater White-fronted Goose			
Ardea alba	Great Egret			
Ardea herodias	Great Blue Heron			
Aythya affinis	Lesser Scaup			
Aythya americana	Redhead		Special Concern	BSSC - Third priority
Aythya collaris	Ring-necked Duck			
Aythya marila	Greater Scaup			
Aythya valisineria	Canvasback		Special	
Botaurus lentiginosus	American Bittern			
Bucephala albeola	Bufflehead			
Bucephala clangula	Common Goldeneye			
Butorides virescens	Green Heron			
Calidris alpina	Dunlin			
Calidris mauri	Western Sandpiper			
Calidris minutilla	Least Sandpiper			
Chen caerulescens	Snow Goose			
Chen rossii	Ross's Goose			
Chlidonias niger	Black Tern		Special Concern	BSSC - Second priority
Cistothorus palustris palustris	Marsh Wren			
Cygnus columbianus	Tundra Swan			
Egretta thula	Snowy Egret			
Empidonax traillii	Willow Flycatcher	Bird of Conservation Concern	Endangered	
Fulica americana	American Coot			
Gallinago delicata	Wilson's Snipe			
Grus canadensis	Sandhill Crane			

<i>Haliaeetus leucocephalus</i>	Bald Eagle	Bird of Conservation Concern	Endangered	
<i>Himantopus mexicanus</i>	Black-necked Stilt			
<i>Icteria virens</i>	Yellow-breasted Chat		Special Concern	BSSC - Third priority
<i>Ixobrychus exilis hesperis</i>	Western Least Bittern		Special Concern	BSSC - Second priority
<i>Limnodromus scolopaceus</i>	Long-billed Dowitcher			
<i>Lophodytes cucullatus</i>	Hooded Merganser			
<i>Megaceryle alcyon</i>	Belted Kingfisher			
<i>Mergus merganser</i>	Common Merganser			
<i>Numenius americanus</i>	Long-billed Curlew			
<i>Numenius phaeopus</i>	Whimbrel			
<i>Nycticorax nycticorax</i>	Black-crowned Night-Heron			
<i>Oxyura jamaicensis</i>	Ruddy Duck			
<i>Pelecanus erythrorhynchos</i>	American White Pelican		Special Concern	BSSC - First priority
<i>Phalacrocorax auritus</i>	Double-crested Cormorant			
<i>Phalaropus tricolor</i>	Wilson's Phalarope			
<i>Piranga rubra</i>	Summer Tanager		Special Concern	BSSC - First priority
<i>Plegadis chihi</i>	White-faced Ibis		Watch list	
<i>Pluvialis squatarola</i>	Black-bellied Plover			
<i>Podiceps nigricollis</i>	Eared Grebe			
<i>Podilymbus podiceps</i>	Pied-billed Grebe			
<i>Porzana carolina</i>	Sora			
<i>Rallus limicola</i>	Virginia Rail			
<i>Recurvirostra americana</i>	American Avocet			
<i>Setophaga petechia</i>	Yellow Warbler			BSSC - Second priority

Tachycineta bicolor	Tree Swallow			
Tringa melanoleuca	Greater Yellowlegs			
Tringa semipalmata	Willet			
Tringa solitaria	Solitary Sandpiper			
Xanthocephalus xanthocephalus	Yellow-headed Blackbird		Special Concern	BSSC - Third priority
CRUSTACEANS				
Lindieriella occidentalis	California Fairy Shrimp		Special	IUCN - Near Threatened
Cambaridae fam.	Cambaridae fam.			
Hyalella spp.	Hyalella spp.			
FISHES				
Acipenser medirostris ssp. 1	Southern green sturgeon	Threatened	Special Concern	Endangered - Moyle 2013
Oncorhynchus mykiss irideus	Coastal rainbow trout			Least Concern - Moyle 2013
Pogonichthys macrolepidotus	Sacramento splittail		Special Concern	Vulnerable - Moyle 2013
Oncorhynchus mykiss - CV	Central Valley steelhead	Threatened	Special	Vulnerable - Moyle 2013
Oncorhynchus tshawytscha - CV spring	Central Valley spring Chinook salmon	Threatened	Threatened	Vulnerable - Moyle 2013
Oncorhynchus tshawytscha - CV winter	Central Valley winter Chinook salmon	Endangered	Endangered	Vulnerable - Moyle 2013
HERPS				
Actinemys marmorata marmorata	Western Pond Turtle		Special Concern	ARSSC
Ambystoma californiense californiense	California Tiger Salamander	Threatened	Threatened	ARSSC
Anaxyrus boreas boreas	Boreal Toad			
Rana boylei	Foothill Yellow-legged Frog	Under Review in the Candidate or Petition Process	Special Concern	ARSSC
Spea hammondi	Western Spadefoot	Under Review in the Candidate	Special Concern	ARSSC

		or Petition Process		
Thamnophis gigas	Giant Gartersnake	Threatened	Threatened	
Thamnophis sirtalis sirtalis	Common Gartersnake			
Pseudacris regilla	Northern Pacific Chorus Frog			
Thamnophis atratus atratus	Santa Cruz Gartersnake			Not on any status lists
INSECTS & OTHER INVERTS				
Aeshnidae fam.	Aeshnidae fam.			
Belostoma spp.	Belostoma spp.			
Caenis spp.	Caenis spp.			
Callibaetis spp.	Callibaetis spp.			
Centroptilum spp.	Centroptilum spp.			
Chironomidae fam.	Chironomidae fam.			
Coenagrionidae fam.	Coenagrionidae fam.			
Corixidae fam.	Corixidae fam.			
Enallagma carunculatum	Tule Bluet			
Ephydriidae fam.	Ephydriidae fam.			
Hydrophilidae fam.	Hydrophilidae fam.			
Hydroptila spp.	Hydroptila spp.			
Hydroptilidae fam.	Hydroptilidae fam.			
Ischnura cervula	Pacific Forktail			
Ischnura spp.	Ischnura spp.			
Leptoceridae fam.	Leptoceridae fam.			
Libellula luctuosa	Widow Skimmer			
Libellula pulchella	Twelve-spotted Skimmer			
Libellula saturata	Flame Skimmer			
Liodessus spp.	Liodessus spp.			
Mideopsis spp.	Mideopsis spp.			
Oxyethira spp.	Oxyethira spp.			
Pachydiplax longipennis	Blue Dasher			

Rhionaeschna multicolor	Blue-eyed Darner			
Sperchon spp.	Sperchon spp.			
Trichocorixa spp.	Trichocorixa spp.			
Tricorythodes spp.	Tricorythodes spp.			
Veliidae fam.	Veliidae fam.			
MAMMALS				
Castor canadensis	American Beaver			Not on any status lists
Lontra canadensis canadensis	North American River Otter			Not on any status lists
Neovison vison	American Mink			Not on any status lists
Ondatra zibethicus	Common Muskrat			Not on any status lists
MOLLUSKS				
Anodonta californiensis	California Floater		Special	
Ferrissia spp.	Ferrissia spp.			
Gonidea angulata	Western Ridged Mussel		Special	
Gyraulus spp.	Gyraulus spp.			
Hydrobiidae fam.	Hydrobiidae fam.			
Lymnaeidae fam.	Lymnaeidae fam.			
Margaritifera falcata	Western Pearlshell		Special	
Physa spp.	Physa spp.			
PLANTS				
Hibiscus lasiocarpus occidentalis			Special	CRPR - 1B.2
Alopecurus carolinianus	Tufted Foxtail			
Ammannia robusta	Grand Redstem			
Anemopsis californica	Yerba Mansa			
Arundo donax	NA			
Bacopa rotundifolia	NA			

<i>Bolboschoenus fluviatilis</i>				Not on any status lists
<i>Callitriche marginata</i>	Winged Water-starwort			
<i>Crassula aquatica</i>	Water Pygmyweed			
<i>Cyperus erythrorhizos</i>	Red-root Flatsedge			
<i>Cyperus iria</i>	NA			Not on any status lists
<i>Downingia bicornuta</i>	NA			
<i>Downingia ornatissima</i>	NA			
<i>Echinodorus berteroi</i>	Upright Burhead			
<i>Eleocharis engelmannii engelmannii</i>	Engelmann's Spikerush			Not on any status lists
<i>Eleocharis macrostachya</i>	Creeping Spikerush			
<i>Epilobium cleistogamum</i>	Cleistogamous Spike-primrose			
<i>Eryngium castrense</i>	Great Valley Eryngo			
<i>Eryngium vaseyi vaseyi</i>	Vasey's Coyote-thistle			Not on any status lists
<i>Euthamia occidentalis</i>	Western Fragrant Goldenrod			
<i>Isoetes howellii</i>	NA			
<i>Lemna minuta</i>	Least Duckweed			
<i>Ludwigia peploides peploides</i>	NA			Not on any status lists
<i>Lythrum californicum</i>	California Loosestrife			
<i>Marsilea vestita vestita</i>	NA			Not on any status lists
<i>Mimulus tricolor</i>	Tricolor Monkeyflower			
<i>Najas guadalupensis guadalupensis</i>	Southern Naiad			
<i>Navarretia cotulifolia</i>	Cotula Navarretia			

Navarretia intertexta	Needleleaf Navarretia			
Navarretia leucocephala leucocephala	White-flower Navarretia			
Panicum dichotomiflorum	NA			
Paspalum distichum	Joint Paspalum			
Persicaria lapathifolia				Not on any status lists
Persicaria maculosa	NA			Not on any status lists
Persicaria punctata	NA			Not on any status lists
Phacelia distans	NA			
Phyla nodiflora	Common Frog- fruit			
Pilularia americana	NA			
Plantago elongata elongata	Slender Plantain			
Platanus racemosa	California Sycamore			
Pogogyne douglasii	NA			
Psilocarphus brevissimus brevissimus	Dwarf Woolly- heads			
Psilocarphus oregonus	Oregon Woolly- heads			
Rorippa curvisiliqua curvisiliqua	Curve-pod Yellowcress			
Sagittaria latifolia latifolia	Broadleaf Arrowhead			
Sagittaria longiloba	Longbarb Arrowhead			
Sagittaria montevidensis calycina				Not on any status lists
Salix exigua exigua	Narrowleaf Willow			
Salix gooddingii	Goodding's Willow			

Salix lasiolepis lasiolepis	Arroyo Willow			
Schoenoplectus acutus occidentalis	Hardstem Bulrush			
Sinapis alba	NA			
Stachys stricta	Sonoma Hedge-nettle			
Typha latifolia	Broadleaf Cattail			



July 2019



IDENTIFYING GDEs UNDER SGMA Best Practices for using the NC Dataset

The Sustainable Groundwater Management Act (SGMA) requires that groundwater dependent ecosystems (GDEs) be identified in Groundwater Sustainability Plans (GSPs). As a starting point, the Department of Water Resources (DWR) is providing the Natural Communities Commonly Associated with Groundwater Dataset (NC Dataset) online¹ to help Groundwater Sustainability Agencies (GSAs), consultants, and stakeholders identify GDEs within individual groundwater basins. To apply information from the NC Dataset to local areas, GSAs should combine it with the best available science on local hydrology, geology, and groundwater levels to verify whether polygons in the NC dataset are likely supported by groundwater in an aquifer (Figure 1)². This document highlights six best practices for using local groundwater data to confirm whether mapped features in the NC dataset are supported by groundwater.

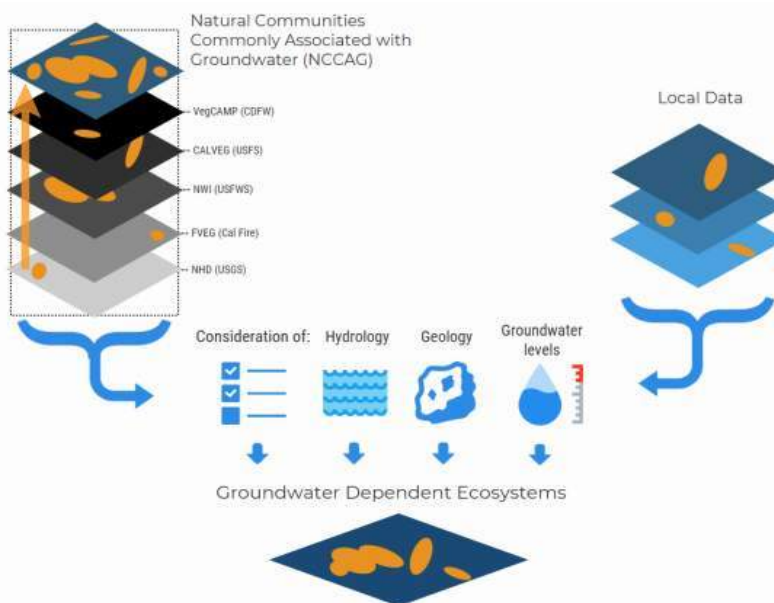

Figure 1. Considerations for GDE identification.
Source: DWR²

¹ NC Dataset Online Viewer: <https://gis.water.ca.gov/app/NCDataSetViewer/>

² California Department of Water Resources (DWR). 2018. Summary of the "Natural Communities Commonly Associated with Groundwater" Dataset and Online Web Viewer. Available at: <https://water.ca.gov/-/media/DWR-Website/Web-Pages/Programs/Groundwater-Management/Data-and-Tools/Files/Statewide-Reports/Natural-Communities-Dataset-Summary-Document.pdf>

The NC Dataset identifies vegetation and wetland features that are good indicators of a GDE. The dataset is comprised of 48 publicly available state and federal datasets that map vegetation, wetlands, springs, and seeps commonly associated with groundwater in California³. It was developed through a collaboration between DWR, the Department of Fish and Wildlife, and The Nature Conservancy (TNC). TNC has also provided detailed guidance on identifying GDEs from the NC dataset⁴ on the Groundwater Resource Hub⁵, a website dedicated to GDEs.

BEST PRACTICE #1. Establishing a Connection to Groundwater

Groundwater basins can be comprised of one continuous aquifer (Figure 2a) or multiple aquifers stacked on top of each other (Figure 2b). In unconfined aquifers (Figure 2a), using the depth-to-groundwater and the rooting depth of the vegetation is a reasonable method to infer groundwater dependence for GDEs. If groundwater is well below the rooting (and capillary) zone of the plants and any wetland features, the ecosystem is considered disconnected and groundwater management is not likely to affect the ecosystem (Figure 2d). However, it is important to consider local conditions (e.g., soil type, groundwater flow gradients, and aquifer parameters) and to review groundwater depth data from multiple seasons and water year types (wet and dry) because intermittent periods of high groundwater levels can replenish perched clay lenses that serve as the water source for GDEs (Figure 2c). Maintaining these natural groundwater fluctuations are important to sustaining GDE health.

Basins with a stacked series of aquifers (Figure 2b) may have varying levels of pumping across aquifers in the basin, depending on the production capacity or water quality associated with each aquifer. If pumping is concentrated in deeper aquifers, SGMA still requires GSAs to sustainably manage groundwater resources in shallow aquifers, such as perched aquifers, that support springs, surface water, domestic wells, and GDEs (Figure 2). This is because vertical groundwater gradients across aquifers may result in pumping from deeper aquifers to cause adverse impacts onto beneficial users reliant on shallow aquifers or interconnected surface water. The goal of SGMA is to sustainably manage groundwater resources for current and future social, economic, and environmental benefits. While groundwater pumping may not be currently occurring in a shallower aquifer, use of this water may become more appealing and economically viable in future years as pumping restrictions are placed on the deeper production aquifers in the basin to meet the sustainable yield and criteria. Thus, identifying GDEs in the basin should be done irrespective to the amount of current pumping occurring in a particular aquifer, so that future impacts on GDEs due to new production can be avoided. A good rule of thumb to follow is: *if groundwater can be pumped from a well - it's an aquifer.*

³ For more details on the mapping methods, refer to: Klausmeyer, K., J. Howard, T. Keeler-Wolf, K. Davis-Fadtke, R. Hull, A. Lyons. 2018. Mapping Indicators of Groundwater Dependent Ecosystems in California: Methods Report. San Francisco, California. Available at: https://groundwaterresourcehub.org/public/uploads/pdfs/iGDE_data_paper_20180423.pdf

⁴ "Groundwater Dependent Ecosystems under the Sustainable Groundwater Management Act: Guidance for Preparing Groundwater Sustainability Plans" is available at: <https://groundwaterresourcehub.org/gde-tools/gsp-guidance-document/>

⁵ The Groundwater Resource Hub: www.GroundwaterResourceHub.org

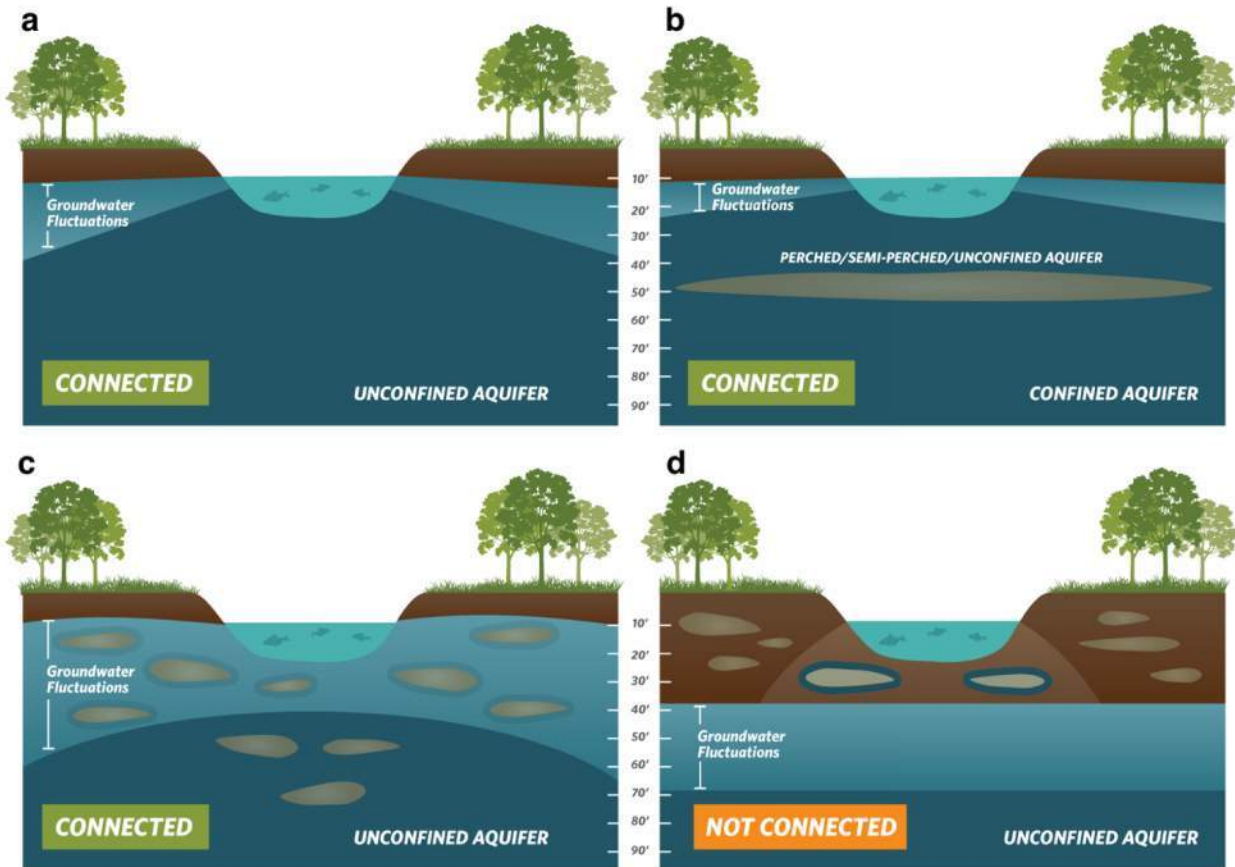

Figure 2. Confirming whether an ecosystem is connected to groundwater. Top: (a) Under the ecosystem is an unconfined aquifer with depth-to-groundwater fluctuating seasonally and interannually within 30 feet from land surface. **(b)** Depth-to-groundwater in the shallow aquifer is connected to overlying ecosystem. Pumping predominately occurs in the confined aquifer, but pumping is possible in the shallow aquifer. **Bottom: (c)** Depth-to-groundwater fluctuations are seasonally and interannually large, however, clay layers in the near surface prolong the ecosystem’s connection to groundwater. **(d)** Groundwater is disconnected from surface water, and any water in the vadose (unsaturated) zone is due to direct recharge from precipitation and indirect recharge under the surface water feature. These areas are not connected to groundwater and typically support species that do not require access to groundwater to survive.

BEST PRACTICE #2. Characterize Seasonal and Interannual Groundwater Conditions

SGMA requires GSAs to describe current and historical groundwater conditions when identifying GDEs [23 CCR §354.16(g)]. Relying solely on the SGMA benchmark date (January 1, 2015) or any other single point in time to characterize groundwater conditions (e.g., depth-to-groundwater) is inadequate because managing groundwater conditions with data from one time point fails to capture the seasonal and interannual variability typical of California’s climate. DWR’s Best Management Practices document on water budgets⁶ recommends using 10 years of water supply and water budget information to describe how historical conditions have impacted the operation of the basin within sustainable yield, implying that a baseline⁷ could be determined based on data between 2005 and 2015. Using this or a similar time period, depending on data availability, is recommended for determining the depth-to-groundwater.

GDEs depend on groundwater levels being close enough to the land surface to interconnect with surface water systems or plant rooting networks. The most practical approach⁸ for a GSA to assess whether polygons in the NC dataset are connected to groundwater is to rely on groundwater elevation data. As detailed in TNC’s GDE guidance document⁴, one of the key factors to consider when mapping GDEs is to contour depth-to-groundwater in the aquifer that is supporting the ecosystem (see Best Practice #5).

Groundwater levels fluctuate over time and space due to California’s Mediterranean climate (dry summers and wet winters), climate change (flood and drought years), and subsurface heterogeneity in the subsurface (Figure 3). Many of California’s GDEs have adapted to dealing with intermittent periods of water stress, however if these groundwater conditions are prolonged, adverse impacts to GDEs can result. While depth-to-groundwater levels within 30 feet⁴ of the land surface are generally accepted as being a proxy for confirming that polygons in the NC dataset are supported by groundwater, it is highly advised that fluctuations in the groundwater regime be characterized to understand the seasonal and interannual groundwater variability in GDEs. Utilizing groundwater data from one point in time can misrepresent groundwater levels required by GDEs, and inadvertently result in adverse impacts to the GDEs. Time series data on groundwater elevations and depths are available on the SGMA Data Viewer⁹. However, if insufficient data are available to describe groundwater conditions within or near polygons from the NC dataset, include those polygons in the GSP until data gaps are reconciled in the monitoring network (see Best Practice #6).

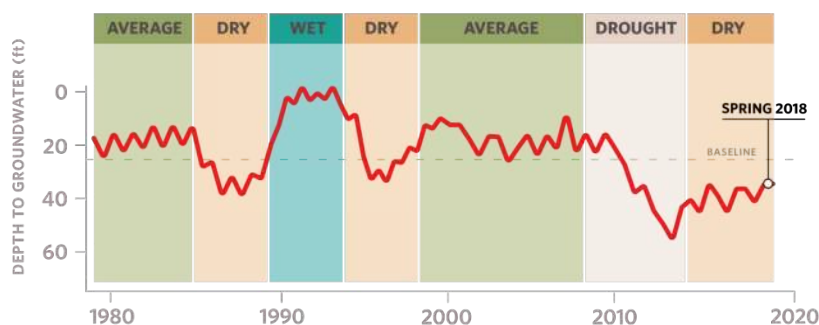

Figure 3. Example seasonality and interannual variability in depth-to-groundwater over time. Selecting one point in time, such as Spring 2018, to characterize groundwater conditions in GDEs fails to capture what groundwater conditions are necessary to maintain the ecosystem status into the future so adverse impacts are avoided.

⁶ DWR. 2016. Water Budget Best Management Practice. Available at:

https://water.ca.gov/LegacyFiles/groundwater/sqm/pdfs/BMP_Water_Budget_Final_2016-12-23.pdf

⁷ Baseline is defined under the GSP regulations as “historic information used to project future conditions for hydrology, water demand, and availability of surface water and to evaluate potential sustainable management practices of a basin.” [23 CCR §351(e)]

⁸ Groundwater reliance can also be confirmed via stable isotope analysis and geophysical surveys. For more information see The GDE Assessment Toolbox (Appendix IV, GDE Guidance Document for GSPs⁴).

⁹ SGMA Data Viewer: <https://sgma.water.ca.gov/webgis/?appid=SGMADataViewer>

BEST PRACTICE #3. Ecosystems Often Rely on Both Groundwater and Surface Water

GDEs are plants and animals that rely on groundwater for all or some of its water needs, and thus can be supported by multiple water sources. The presence of non-groundwater sources (e.g., surface water, soil moisture in the vadose zone, applied water, treated wastewater effluent, urban stormwater, irrigated return flow) within and around a GDE does not preclude the possibility that it is supported by groundwater, too. SGMA defines GDEs as "ecological communities and species that depend on groundwater emerging from aquifers or on groundwater occurring near the ground surface" [23 CCR §351(m)]. Hence, depth-to-groundwater data should be used to identify whether NC polygons are supported by groundwater and should be considered GDEs. In addition, SGMA requires that significant and undesirable adverse impacts to beneficial users of surface water be avoided. Beneficial users of surface water include environmental users such as plants or animals¹⁰, which therefore must be considered when developing minimum thresholds for depletions of interconnected surface water.

GSAs are only responsible for impacts to GDEs resulting from groundwater conditions in the basin, so if adverse impacts to GDEs result from the diversion of applied water, treated wastewater, or irrigation return flow away from the GDE, then those impacts will be evaluated by other permitting requirements (e.g., CEQA) and may not be the responsibility of the GSA. However, if adverse impacts occur to the GDE due to changing groundwater conditions resulting from pumping or groundwater management activities, then the GSA would be responsible (Figure 4).

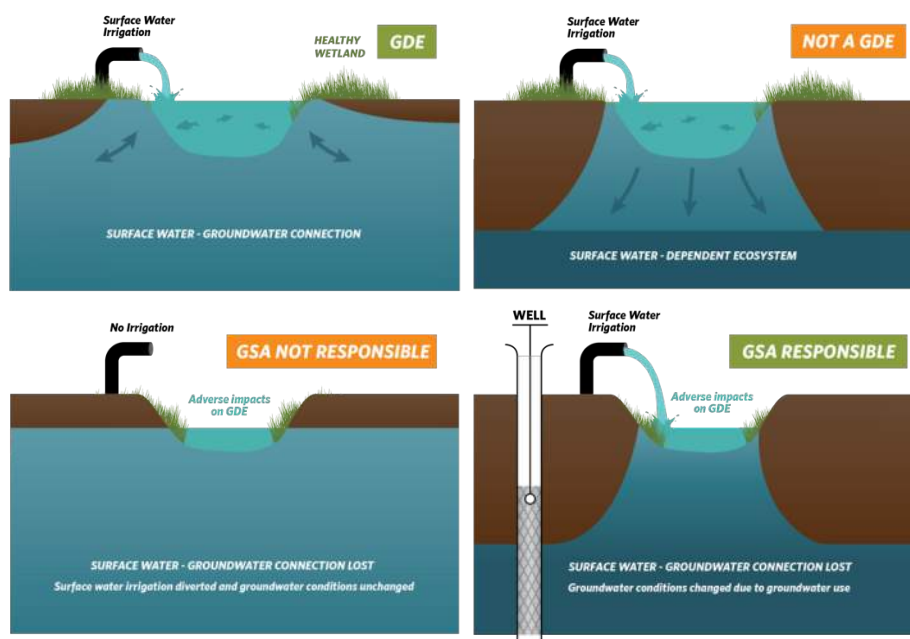

Figure 4. Ecosystems often depend on multiple sources of water. Top: (Left) Surface water and groundwater are interconnected, meaning that the GDE is supported by both groundwater and surface water. **(Right)** Ecosystems that are only reliant on non-groundwater sources are not groundwater-dependent. **Bottom: (Left)** An ecosystem that was once dependent on an interconnected surface water, but loses access to groundwater solely due to surface water diversions may not be the GSA's responsibility. **(Right)** Groundwater dependent ecosystems once dependent on an interconnected surface water system, but loses that access due to groundwater pumping is the GSA's responsibility.

¹⁰ For a list of environmental beneficial users of surface water by basin, visit: <https://groundwaterresourcehub.org/gde-tools/environmental-surface-water-beneficiaries/>

BEST PRACTICE #4. Select Representative Groundwater Wells

Identifying GDEs in a basin requires that groundwater conditions are characterized to confirm whether polygons in the NC dataset are supported by the underlying aquifer. To do this, proximate groundwater wells should be identified to characterize groundwater conditions (Figure 5). When selecting representative wells, it is particularly important to consider the subsurface heterogeneity around NC polygons, especially near surface water features where groundwater and surface water interactions occur around heterogeneous stratigraphic units or aquitards formed by fluvial deposits. The following selection criteria can help ensure groundwater levels are representative of conditions within the GDE area:

- Choose wells that are within 5 kilometers (3.1 miles) of each NC Dataset polygons because they are more likely to reflect the local conditions relevant to the ecosystem. If there are no wells within 5km of the center of a NC dataset polygon, then there is insufficient information to remove the polygon based on groundwater depth. Instead, it should be retained as a potential GDE until there are sufficient data to determine whether or not the NC Dataset polygon is supported by groundwater.
- Choose wells that are screened within the surficial unconfined aquifer and capable of measuring the true water table.
- Avoid relying on wells that have insufficient information on the screened well depth interval for excluding GDEs because they could be providing data on the wrong aquifer. This type of well data should not be used to remove any NC polygons.

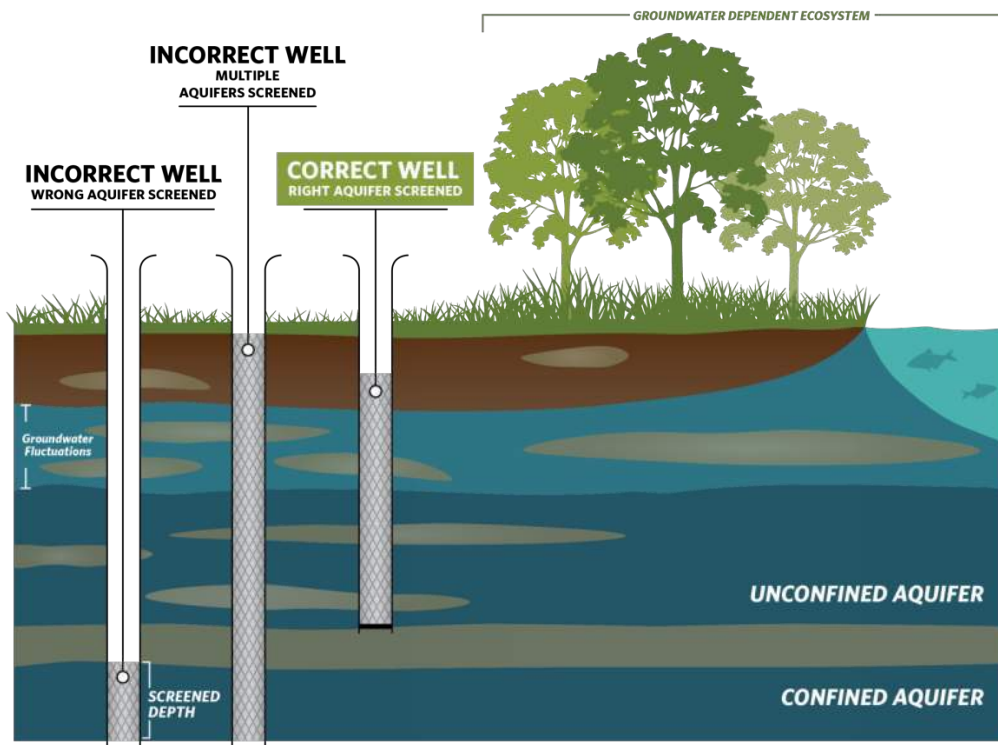

Figure 5. Selecting representative wells to characterize groundwater conditions near GDEs.

BEST PRACTICE #5. Contouring Groundwater Elevations

The common practice to contour depth-to-groundwater over a large area by interpolating measurements at monitoring wells is unsuitable for assessing whether an ecosystem is supported by groundwater. This practice causes errors when the land surface contains features like stream and wetland depressions because it assumes the land surface is constant across the landscape and depth-to-groundwater is constant below these low-lying areas (Figure 6a). A more accurate approach is to interpolate **groundwater elevations** at monitoring wells to get groundwater elevation contours across the landscape. This layer can then be subtracted from land surface elevations from a Digital Elevation Model (DEM)¹¹ to estimate depth-to-groundwater contours across the landscape (Figure b; Figure 7). This will provide a much more accurate contours of depth-to-groundwater along streams and other land surface depressions where GDEs are commonly found.

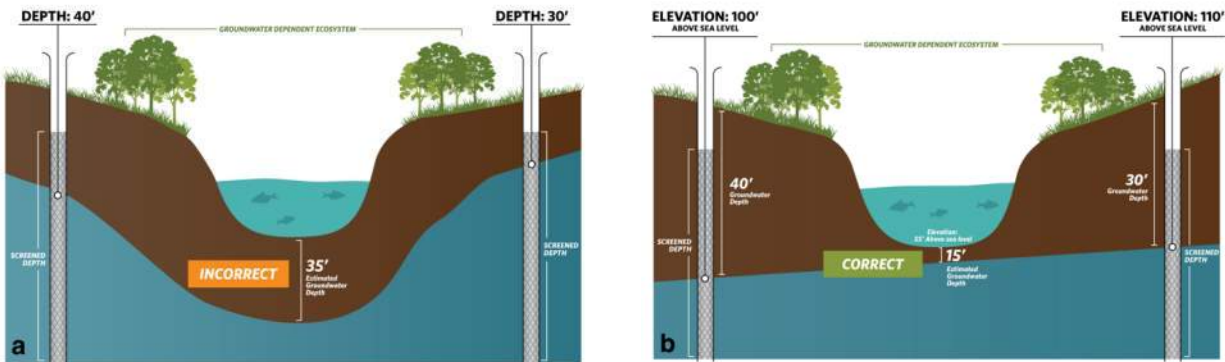

Figure 6. Contouring depth-to-groundwater around surface water features and GDEs. (a) Groundwater level interpolation using depth-to-groundwater data from monitoring wells. **(b)** Groundwater level interpolation using groundwater elevation data from monitoring wells and DEM data.

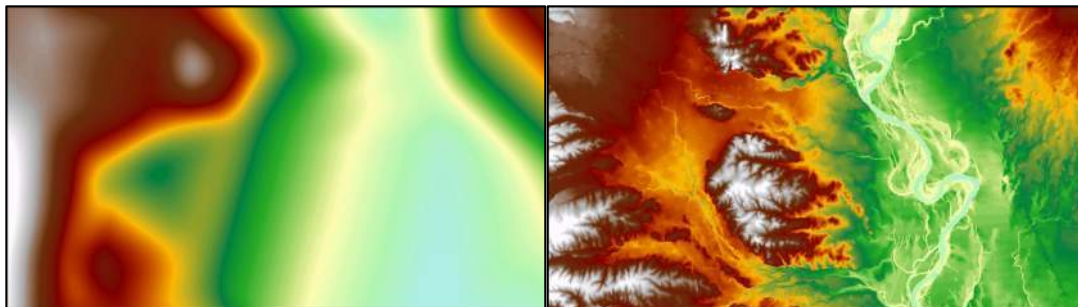

Figure 7. Depth-to-groundwater contours in Northern California. (Left) Contours were interpolated using depth-to-groundwater measurements determined at each well. **(Right)** Contours were determined by interpolating groundwater elevation measurements at each well and superimposing ground surface elevation from DEM spatial data to generate depth-to-groundwater contours. The image on the right shows a more accurate depth-to-groundwater estimate because it takes the local topography and elevation changes into account.

¹¹ USGS Digital Elevation Model data products are described at: <https://www.usgs.gov/core-science-systems/nep/3dep/about-3dep-products-services> and can be downloaded at: <https://iewer.nationalmap.gov/basic/>

BEST PRACTICE #6. Best Available Science

Adaptive management is embedded within SGMA and provides a process to work toward sustainability over time by beginning with the best available information to make initial decisions, monitoring the results of those decisions, and using the data collected through monitoring programs to revise decisions in the future. In many situations, the hydrologic connection of NC dataset polygons will not initially be clearly understood if site-specific groundwater monitoring data are not available. If sufficient data are not available in time for the 2020/2022 plan, **The Nature Conservancy strongly advises that questionable polygons from the NC dataset be included in the GSP until data gaps are reconciled in the monitoring network.** Erring on the side of caution will help minimize inadvertent impacts to GDEs as a result of groundwater use and management actions during SGMA implementation.

KEY DEFINITIONS

Groundwater basin is an aquifer or stacked series of aquifers with reasonably well-defined boundaries in a lateral direction, based on features that significantly impede groundwater flow, and a definable bottom. *23 CCR §341(g)(1)*

Groundwater dependent ecosystem (GDE) are ecological communities or species that depend on groundwater emerging from aquifers or on groundwater occurring near the ground surface. *23 CCR §351(m)*

Interconnected surface water (ISW) surface water that is hydraulically connected at any point by a continuous saturated zone to the underlying aquifer and the overlying surface water is not completely depleted. *23 CCR §351(o)*

Principal aquifers are aquifers or aquifer systems that store, transmit, and yield significant or economic quantities of groundwater to wells, springs, or surface water systems. *23 CCR §351(aa)*

ABOUT US

The Nature Conservancy is a science-based nonprofit organization whose mission is *to conserve the lands and waters on which all life depends*. To support successful SGMA implementation that meets the future needs of people, the economy, and the environment, TNC has developed tools and resources (www.groundwaterresourcehub.org) intended to reduce costs, shorten timelines, and increase benefits for both people and nature.

Attachment E

Maps of representative monitoring sites in relation to key beneficial users

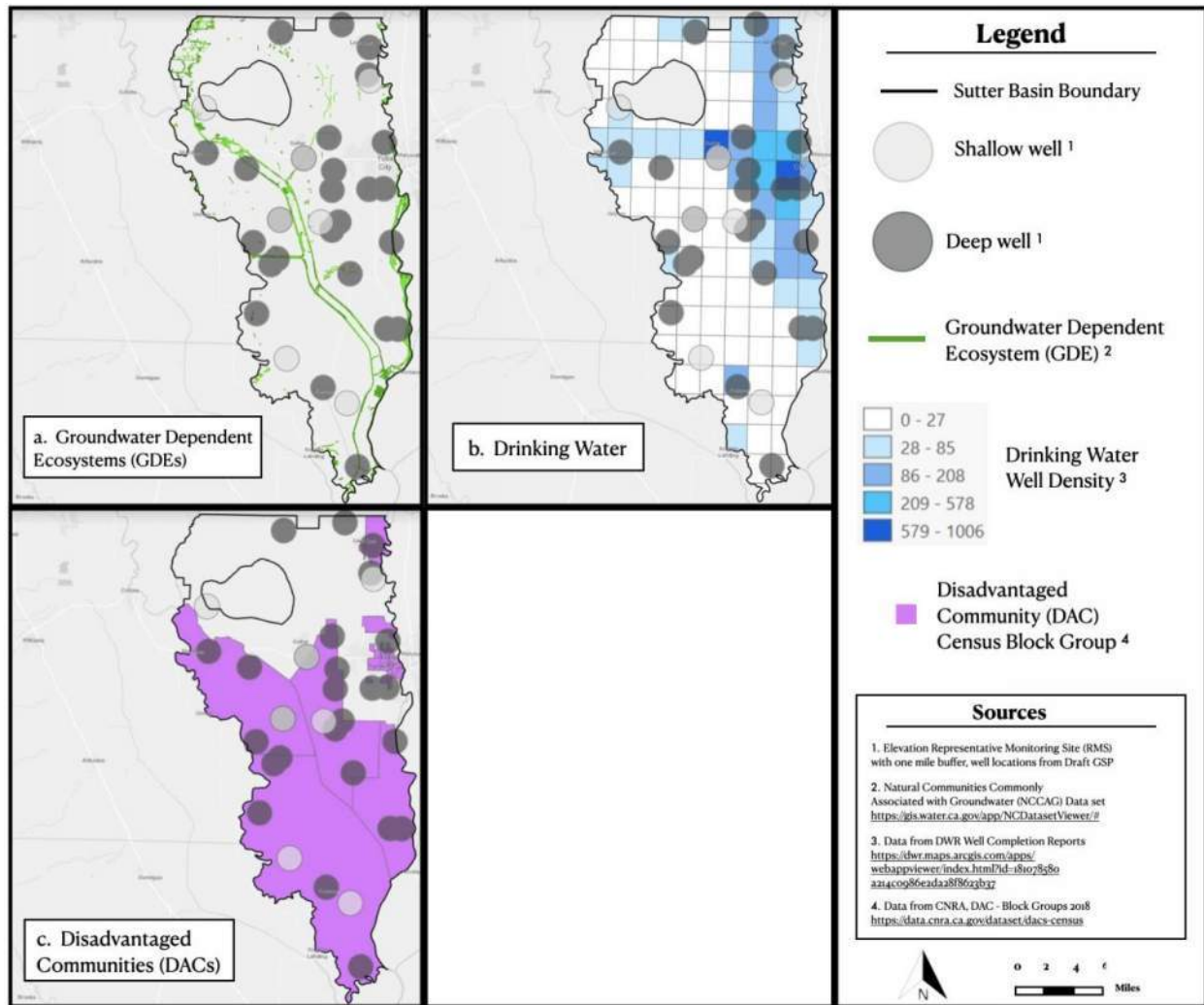

Figure 1. Groundwater elevation representative monitoring sites in relation to key beneficial users: a) Groundwater Dependent Ecosystems (GDEs), b) Drinking Water users, c) Disadvantaged Communities (DACs), and d) Tribes.

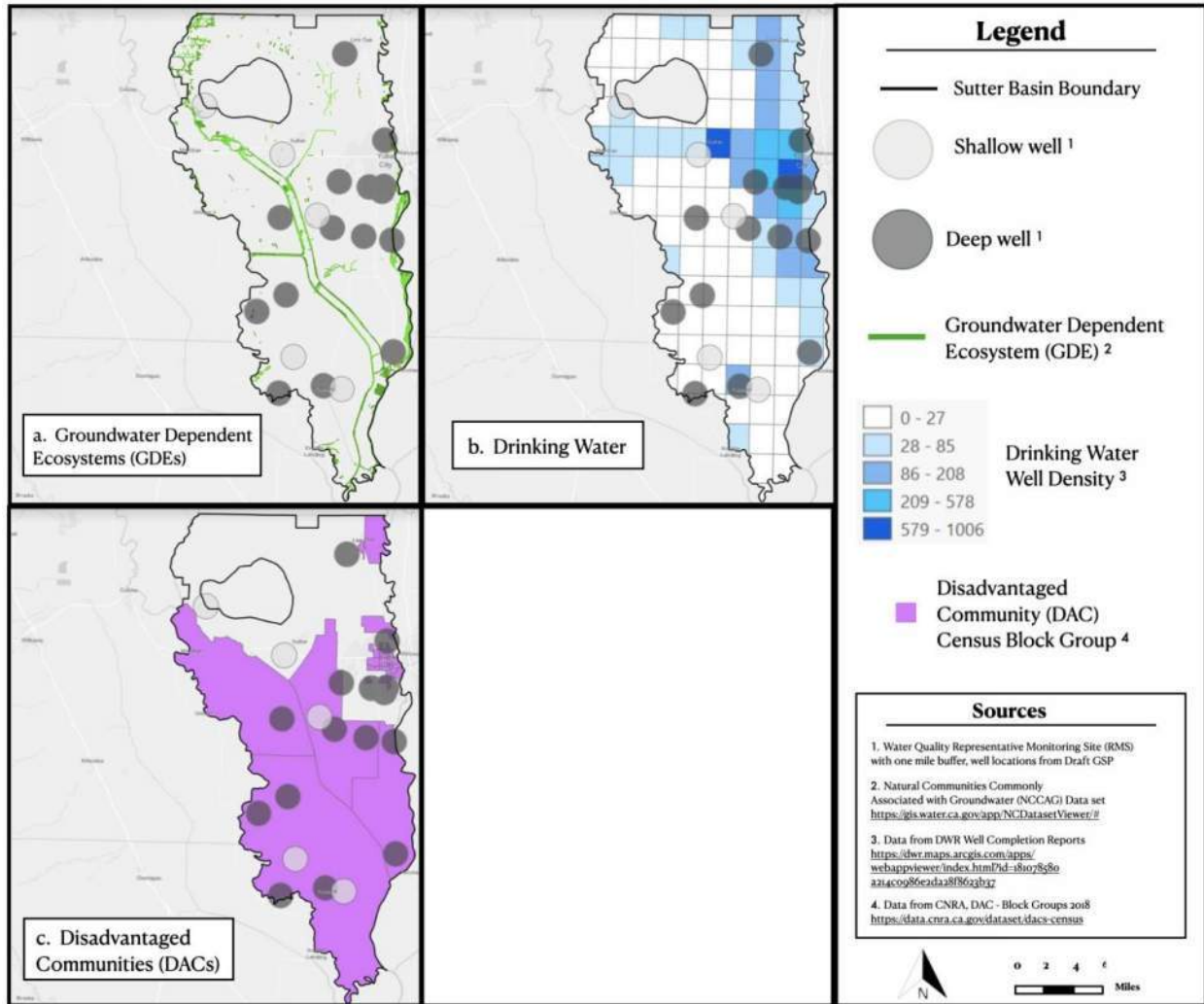

Figure 2. Groundwater quality representative monitoring sites in relation to key beneficial users: a) Groundwater Dependent Ecosystems (GDEs), b) Drinking Water users, c) Disadvantaged Communities (DACs), and d) Tribes.



Sutter Subbasin <info@suttersubbasin.org>

Sutter Subbasin GSP Chapters 5,6 & 7

1 message

Ben King <bking@pacgoldag.com>
 To: Sutter Subbasin <info@suttersubbasin.org>
 Cc: Ben King <bking@pacgoldag.com>

Fri, Nov 12, 2021 at 11:10 AM

Hi Leslie,

Here are my Comments to Chapters 5, 6& 7: :

1. 5.1 The should be a short discussion about the missile silos constructed on the northern side of the Sutter Buttes as part of the 851st Strategic Missile Squadron – Site 851-B since the structural changes for the missile silo(s) may have some impact on the groundwater quality for the adjacent GDE and its proximity to Grey Lodge. It may be nothing but since the geology of the ancient volcanic structure and related fault/dome structures there may be a possibility of upwelling of saline water and/or the translocation of naturally occurring contaminants consistent with the geology and hydrochemistry of that particular area. See “ Cold War relics: Deactivated Titan 1 missile silos surround Beale “ by Senior Airman Allen Pollard, 9th Reconnaissance Wing Public Affairs/Published June 07, 2013. 51
2. 5.1.3 The Bottom of the Sutter Subbasin can not be best approximated by using Berkstresser, 1973. The Colusa and Yolo GSPs are using Olmstead and Davis, 1961 which has a more appropriate EC level of 2000 rather than 3000. It was not totally clear to me if the Butte Subbasin GSP was using a modified approach to Olmstead and Davis because there was a reference to a DWR source but it is clear that the adjacent GSPs have not incorporated any updated fresh water contours that the DWR has considered as part of the work done by Springhorn et. al. as presented to The Geological Society of America on May 2013. Furthermore it is clear that the BFW and assumptions for available stored water and sustainable yield for the Sutter Subbasin is wrong or at least based on unreliable data since there is abundant empirical evidence that the BFW in many places of the Subbasin is much less than 200 feet. There is only one water quality sample or water quality portion in the Appendix and that shows a NaCL TDs of 2789 at a depth of 95 to 145 feet for a well near Robbins. Literally the Water Budget for the Sutter Subbasin should be taken with a grain of salt (and in some places a concerning amount of arsenic) at this point. Regarding the empirical data we are at the early stages of quantitative analysis by unbiased independent Stakeholders but I would reference the work done in the research article “ Base of fresh water, groundwater salinity, and well distribution across California” by Mary Kang, Debra Perrone, Ziming Wang, Scott Jasechiko and Mellisa M. Rohde , PMAS December 22, 2020. This work is a good start to highlight the very concerning data gaps and inconsistent approaches to defining BFW levels in California and the Sacramento Valley. 52
3. Figure 5-7 The Project Area delineation is not meaningful and should be edited out. The whole of the Subbasin should be considered as one hydrological unit. 53
4. Section 5.1.7.2 Recharge Areas Page 5-50 There is a substantial part of the Sutter Subbasin that is flooded for several winter months with substantial depths of flooding – particularly the area that comprises the Sutter Bypass and the confluence of the Sacramento River and Butte Creek flood zones. The C2VSimFG Model in the Appendix addresses flood induced groundwater infiltration for Pondered Crop effects in Section 2.5 and Model Calibration in 3.1 but the net benefit of enhanced infiltration is being missed or underestimated for the water budget subareas subject to flooding and/or seepage in the Sutter Subbasin. 54
5. 5.1.9 See my previous comments regarding USGS Gamma site EASC-21 and the discussion about arsenic. This discussion needs to highlight the recent work done by the USGS on water quality, redox and the likely movement of arsenic contamination along the Willows Fault. 55
6. Figure 5-27 The Groundwater Quality Wells are not representative. There should be a time series of TDS and Arsenic contamination observations in the Appendix 56
7. Section 5.1.9.3 There should be a table for the two contaminated wells at the Barry School and the elementary school in Meridian and the other sites with arsenic contamination observations above the MCL that I included in my previous comments. It should be noted that there is an agreement with the EPA regarding the contamination at Robbins. The second paragraph on Page 5-74 avoids making the predicted connection (see Thiros and Bexfield Model in previously supplied USGS Paper) about the connection between high pH saline water and metal 57

- oxides from volcanic rock that exist down elevation from the Sutter Buttes. Arsenic contamination is expected to occur in the Sutter Subbasin as it does in the area around Albuquerque N.M. as highlighted by the recent work of the USGS. This is also probably aggravated by translocation of arsenic along the Willows Fault which generally runs concurrent with the path of the Sutter Bypass. 57
8. Figure 5-35 This is a good Figure – the data points referenced in Figure 5-35 should be represented as a time series of observations and included in the Appendix. 58
9. Figure 5-38 These are good Figures – these data points referenced in Figure 5-38 should be represented as a time series of observations and included in the Appendix. 59
10. Section 5.1.12.4/5 - As mentioned above a large portion of the Sutter Subbasin benefits from seasonal flooding and seepage for several months during wet years. This enhanced infiltration should be included in the Water Budget by Budget subareas that encompass the seepage and/or seasonal flooding which may come with substantial flood heads and last for several months especially during wet years. 60
11. Figures 5- 50 to-58 - The Project area delineation on the several Figures should be removed since the Subbasin is one hydrological unit. 61
12. Figures 5-77 to 81 Same comment as above 62
13. 5.2.5 The use of median averages should not be used for determination of water quality. I may be a case for professional negligence to do so since the adverse health concentrations for water quality contamination is determined by the observations of concentrations in excess of a MCL. It could have been that the median concentration of lead contamination in Flint Michigan was below the EPA MCL but that does not mean that people were not poisoned by lead in their water systems. For the example the discussion in this Section regarding arsenic contamination is not based on a reasonable set of statistic principles because it is based on uneven sampling year sets, likely different sampling sites and the use of a median average. What should be considered is the trends of contamination above the MCL by itself – are certain water systems contaminated based on a MCL and does that trend continue based on a continuous observation time set. For example if the observations for the Meridian elementary school, the Barry School, the supply system for Robbins and the supply system for Wildwood Mutual were all 25 ug/L and six other observations were at 8 ug/L then the median average would be 8 ug/L but the school children at Meridian, Barry School and pregnant women who drank untreated water from Robbins an Wildwood would all be susceptible to arsenic poisoning. The discussion should focus on the trends in elevated arsenic observations at contaminated supply systems and wells – the use of median averages may be professional negligence. 63
14. 5.2.8 As discussed above the presence of the abandoned Titan Missile silos on the north side of the Sutter Buttes should be discussed and some future work should be taken to rule out any contamination potential from the construction or decommission of the silo(s) on the adjacent GDE. 64
15. Section 5-3 As discussed above the BFW assumptions used for the Water Budget are not reasonable if Berkstresser is used. Olmstead and Davis may be acceptable for the time being but the work done by Springhorn and presented in 2013 is probably the best set of assumptions at this point in the implementation of SGMA. Additionally the enhanced infiltration from flooding and seepage should be considered for wet year scenarios in the various base assumptions. There are substantial parts of the Sutter Subbasin that have deep floodwaters for several months and/or benefit from extended seepage that sometime presents above ground near the Sacramento River and the Sutter Bypass. 65
16. Section 6.4.3.1 Pages 6-7/8 – There should be a SMC for arsenic contamination and it should be the USEPA MCL of 10 ug/L. 66
17. Section 6.4.3.2. The elevated pH from the saline water and the metal oxides from the volcanic rocks of the Sutter Buttes is definitely a Potential Cause for the arsenic contamination present in the Sutter Subbasin. The Sutter Yuba investigations (see previously submitted reference – this was a study published by the SWRCB in 1952) identified overpumping as far back as 1930 as a Potential Cause of elevated TDS levels in groundwater. 67
18. Page 7-14 Projects and Management Actions. Suter Buttes Salinity Monitoring PMA and Sutter Buttes Water Quality Inter-Basin Working Group PMAs. I previously submitted a PMA that was also submitted for the Colusa Subbasin GSP that focused on the worked done by Steven Springhorn relating to the stratigraphy of the Sutter Buttes in 2008. The Future Work section of Springhorn's Paper focuses on the interrelationship of the geology of the Sutter Buttes Rampart and the arsenic contamination found in the sphere of the Sutter Buttes Geomorphic Unit. The descriptions for these two PMAs should reference arsenic contamination to give it these PMAs the focus and priority they demand due to the public health consequences identified by Springhorn. The discussion about arsenic contamination should not be hidden from Stakeholders and these PMAs should be prioritized especially since they directly relate to HTRW priorities and have distinct likely negative racial equity outcomes. 68



Sutter Subbasin <info@suttersubbasin.org>

Sutter Subbasin Draft GSP Appendix Comments

Ben King <bking@pacgoldag.com>
 To: Sutter Subbasin <info@suttersubbasin.org>
 Cc: Ben King <bking@pacgoldag.com>

Fri, Nov 12, 2021 at 11:15 AM

Hi Leslie,

Here are my Comments on the Appendix:

1. There is not Appendix 2-A - Were there any letter comments to the SCGSA?

69

2. There is no log of Comments from any meeting or any Comment Submittal. How are Stakeholders to be informed of other Stakeholder concerns and perspectives in order to make Comments on the Draft GSP?

I have no idea if my Comments on Draft Chapters were considered and what the comments were at any meeting. There does appear to be 5 comments to the survey but that appears to be all the Comments presented to the public at during the entirety of the Comment Period for the Draft GSP. I do know that my comments to the HCM were received but I did not get a confirmation for the receipt of my PMA submittal or Comments on any draft Chapter outside of the HCM. I do not see any reference to my project submittal in the PMAs listed in the Appendix.

70

3. Appendix 4-E The 5 comments on the Survey which comprise the totality of the Comments disclosed are interesting. Groundwater Recharge, Water for Wildlife Habitat, to be informed, green solution investment and investment in Live Oak and Farming were primary interests – all good comments. The Groundwater management concerns were about agricultural pumping causing pollution to groundwater and supply issues, overdraft, groundwater substitution and sale of groundwater to southern California, building in Live Oak and fear that the GSA will cut off well supplies.

71

5. Appendix 5-A Note that the Welenco Log Reported a NaCL TDS of 2789 and a NaHCo3 TDS of 5000 at 95 to 145 feet near Robbins. The NaCL TDS was 3533 at 1250 feet – the TDS of the shallow well depth had the worse water quality with the exception of the 1250 well depth.

72

6. Appendix 5-G C2VSimFG- Sutter Model Report

There is a Reference error on Page 15 – Section 2.6.1 regarding diversion data.

Section 3 Model Calibration

- Are there any adjustments regarding vertical or horizontal flows associated with the presence of the Willows Fault?
- Are there any adjustments regarding the persistence of upwhelling in the Sutter Subbasin?
- Why isn't there upwhelling near Robbins where the salinity and arsenic contamination is the worse – any empirical work done on this to recalibrate the Model?
- As discussed further in the Comments regarding the Water Budget, the Model should be calibrated for the enhanced infiltration from seasonal flooding in the Sutter Subbasin during wet years. There is substantial infiltration from seepage from the Sacramento and Feather Rivers and the Sutter Bypass. There is also substantial enhanced infiltration from seasonal flooding impacted by the confluence of Butte Creek and the Sacramento River, the high water

73

depths of flooding in the Sutter Bypass and other flooding and seepage sites to the east of the Subbasin from the Feather River and other sites I am not so familiar with.

73

7. Appendix 6 There are no graphs relating to the Groundwater Quality SMC. There should be graphs for TDS/EC for selected wells and all public supply systems and arsenic contamination for the schools and public supply systems with arsenic contamination greater than the EPA max of 10 U_g/L

74

8. Appendix 7-B The project submittals are incomplete – there are only the Feather River Region submittals which date back 7 years to August 2014. Stakeholders have not disclosure for the basis for all the other PMAs listed in 7-A

75

Appendix 4-D
Notice of Intent to Prepare a Groundwater Sustainability
Plan

This page intentionally left blank.

Notice of Intent to Begin Preparation of a Groundwater Sustainability Plan for the Sutter Subbasin of the Sacramento Valley Groundwater Basin

This is to notify the California Department of Water Resources (DWR) and interested parties of the intent to begin activities to prepare a Groundwater Sustainability Plan (GSP) for the Sutter Subbasin in a portion of Sutter County. Also being notified are the applicable cities in the Sutter Subbasin, as well as the California Public Utilities Commission. The Sutter Subbasin includes nine Groundwater Sustainability Agencies (GSAs): Butte Water District GSA; City of Live Oak GSA; City of Yuba City GSA; RD 70 GSA; RD 1500 GSA; RD 1660 GSA; Sutter Community Service District GSA; Sutter County GSA; and Sutter Extension Water District GSA. The nine GSAs are closely coordinating to prepare a single GSP for the Sutter Subbasin. Sutter County has been authorized by the Sutter Subbasin GSAs to submit the GSP Initial Notification to DWR. The process for developing the GSP will begin with completion of a communication and outreach plan by each GSA. Additionally, a webpage is anticipated to be developed that will be used for continued interested party engagement. When complete, interested parties will be able to sign up to receive notifications related to GSP development activities of any of the Sutter Subbasin GSAs. The next phase of GSP development will involve filling of critical data gaps to improve the understanding of conditions relative to groundwater in the Subbasin to assess current and future sustainability of the Subbasin's groundwater resources. With this information, a draft GSP will be developed with a planned public draft release in the third quarter of 2021 and a final GSP in the fourth quarter of 2021. Stakeholders interested in the development and future implementation of the Sutter Subbasin GSP may contact Guadalupe Rivera of the Sutter County GSA at GRivera@co.sutter.ca.us or 530-822-7400, extension 305. Additionally, stakeholders interested in a specific GSA area within the Sutter Subbasin can contact the individuals listed at the bottom of the enclosed map of the Subbasin area and GSA boundaries.

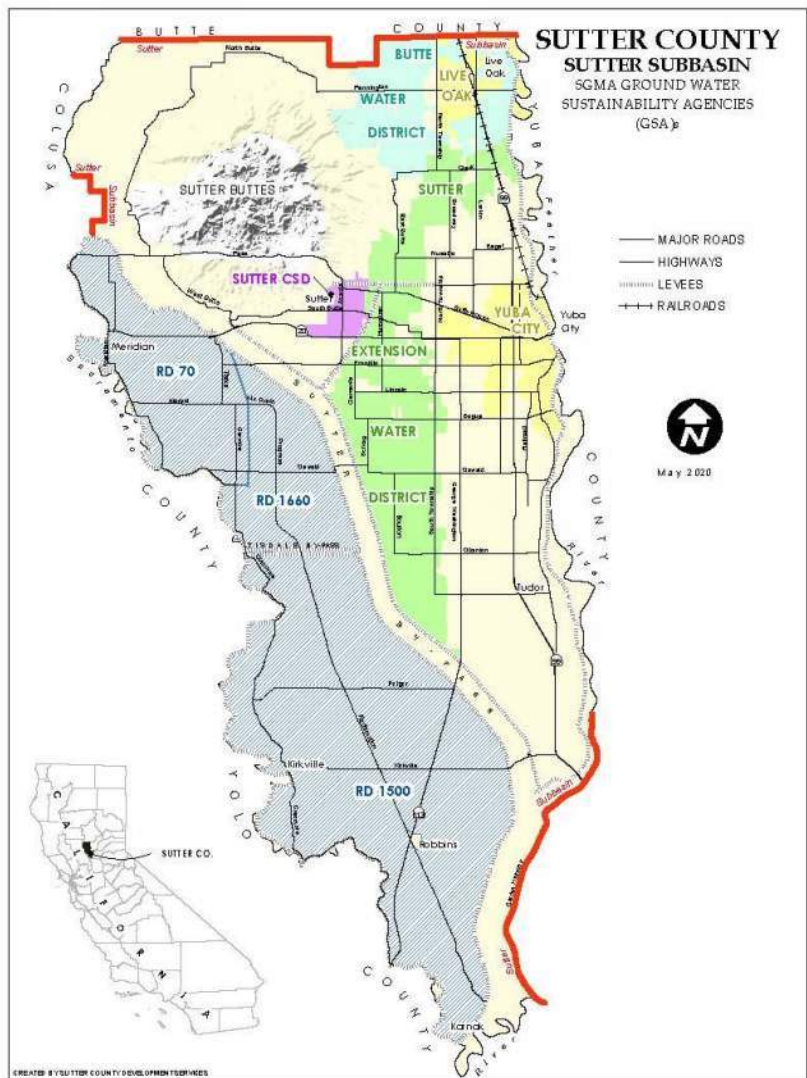

Contacts

Butte Water District GSA

Mark Orme
 530-846-3100 or morme@buttewater.net

City of Live Oak GSA

Nicole Rosser
 530-742-5982 or ndelerio@yubasutterlaw.com

City of Yuba City GSA

Kevin Bradford
 530-822-4786 or kbradfor@yubacity.net

RD 70 GSA

Rebecca Smith
 916-444-1000 or rsmith@downeybrand.com

RD 1500 GSA

Brad Mattson
 530-738-4423

RD 1660 GSA

Rebecca Smith
 916-444-1000 or rsmith@downeybrand.com

Sutter Community Service District GSA

Leland Correll
 530-755-1733 or sutterwater@aol.com

Sutter County GSA

Guadalupe Rivera
 530-822-7400 or grivera@co.sutter.ca.us

Sutter Extension Water District GSA

Lynn Phillips
 530-870-1712 or lpsewd@hughes.net

Appendix 4-E
Notice of Intent to Adopt a Groundwater Sustainability Plan
and Adopting Resolutions

This page intentionally left blank.



SUTTER COUNTY

DEVELOPMENT SERVICES DEPARTMENT

Building Inspection
Code Enforcement

Engineering/Water Resources
Environmental Health

Planning
Road Maintenance

NOTICE OF INTENT TO ADOPT A GROUNDWATER SUSTAINABILITY PLAN

October 5, 2021

Via email

RE: Notice of Intent to Adopt a Groundwater Sustainability Plan – Sutter Subbasin

To Whom It May Concern,

On behalf of the Groundwater Sustainability Agencies (GSAs) comprising the Sutter Groundwater Subbasin (as listed below), pursuant to California Water Code Section 10728.4, the Sutter County Groundwater Sustainability Agency (Sutter County GSA) hereby provides notice to the legislative body of any City, County, or Public Utilities Commission-regulated company within the geographic area covered by the pending Sutter Groundwater Sustainability Plan (GSP) that it intends to adopt the GSP for the Sutter Groundwater Subbasin (Basin No. 5-021.62). A map of the GSP area is included herein.

Interested parties may provide comments on the Public Draft GSP during the scheduled public comment period, October 1 through November 12, 2021. Information regarding the Draft GSP has been posted on the Subbasin website at www.suttersubbasin.org. In accordance with California Water Code Section 10728.4, the Sutter Subbasin GSAs will review and consider comments on the GSP from any city or county who receives this notification and will provide consultation upon request. Requests for consultation, however, must be received within 30 days from receipt of this notification. Interested parties wishing to provide comments on the GSP or requesting consultation are encouraged to do so electronically at the following site: www.suttersubbasin.org/contact-us.html.

The Sutter GSP will be adopted individually by each Subbasin GSA. Adopting meetings will be held between December 1, 2021 and January 30, 2022. The dates for adopting meetings will vary by GSA; for information on individual GSA adoption dates, please refer to the Sutter Subbasin website.

The Sutter GSAs look forward to adopting the GSP in the Sutter Subbasin. Should you have any questions about this notice, please feel free to contact me by email at GRivera@co.sutter.ca.us or by phone at 530.822.7400, Ext. 305.

Sincerely,

Guadalupe Rivera, PE
Principal Engineer
Sutter Subbasin Plan Administrator

Sutter Subbasin GSAs:

- Sutter County
- Butte Water District
- City of Live Oak
- Sutter Extension Water District
- Sutter Community Services District
- City of Yuba City
- Reclamation District 70
- Reclamation District 1660
- Reclamation District 1500

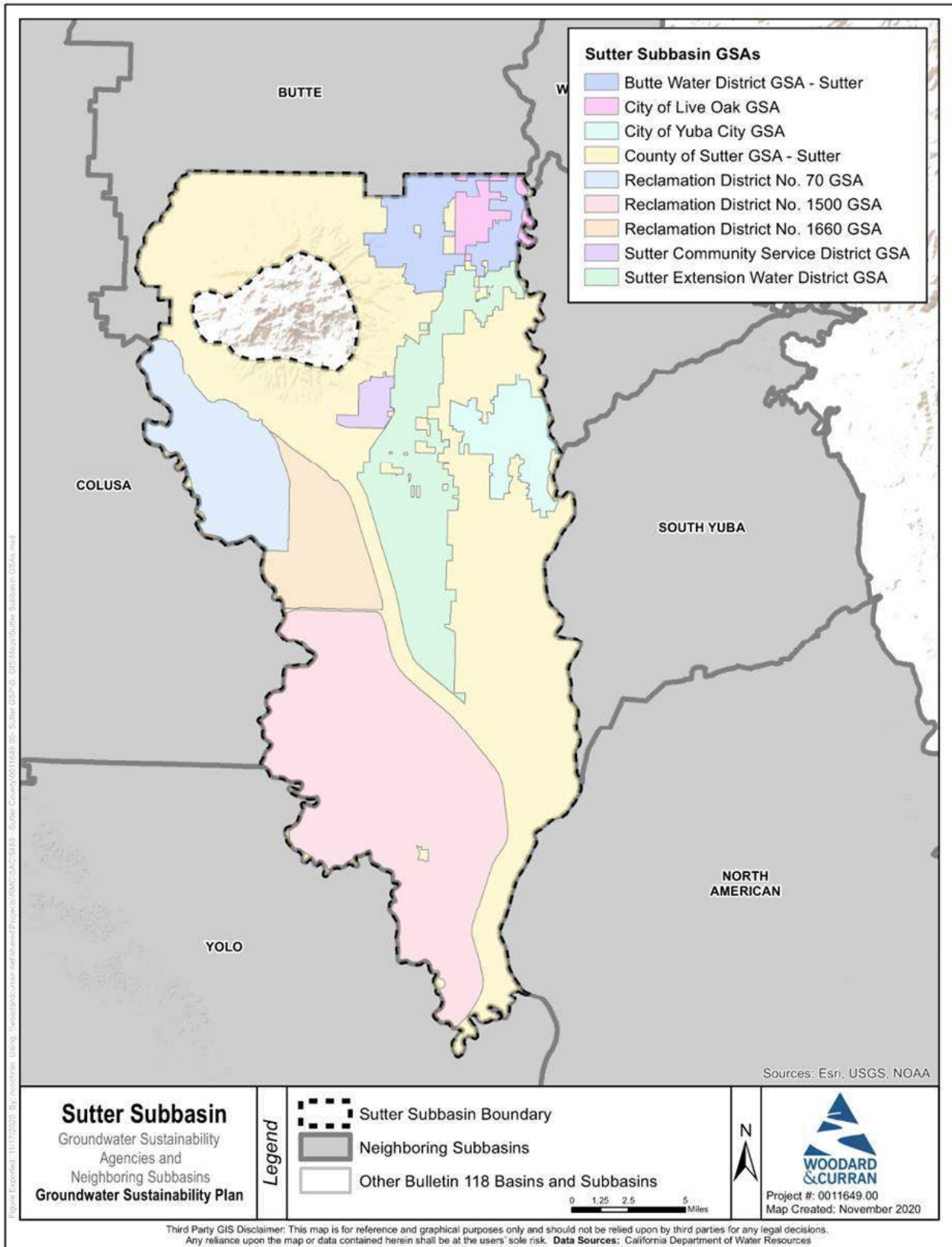

DIRECTORS:

*Charlie Etcheverry
Darin Pantaleoni
Pete Righero
Dale Smith
Pete Waller*



*Mark Orme
Secretary-Manager*

*735 Virginia Street
Gridley, California 95948*

*Phone 530-846-3100
buttewaterdistrict.org*

NOTICE/AGENDA
REGULAR BOARD MEETING OF THE BOARD OF DIRECTORS OF
BUTTE WATER DISTRICT
JANUARY 13, 2022 AT 1:00PM

1. BWD Call to Order – President, Darin Pantaleoni:

a. Flag Salute

2. Acknowledgement of Visitors and Public Comments:

The public will be given an opportunity to address the Board on matters within the District's jurisdiction that are not scheduled on the agenda, although the Board cannot take action on any matter not on the agenda. An opportunity for comments on agenda items will be provided at the time they are discussed by the Board. All comments will be limited to 5 minutes per speaker

3. Approval of the Minutes:

4. Approval of the Bills:

5. Conduct Public Hearing and Consider Adoption of Sutter Subbasin Groundwater Sustainability Plan:

A. Staff Introduction

B. Public Hearing

C. Consider Adoption of Resolution 2022-01

6. SGMA Report:

7. Manager's/Joint Report:

8. Adjournment:

RESOLUTION NO. 2022-01

**RESOLUTION ADOPTING THE SUTTER SUBBASIN GROUNDWATER
SUSTAINABILITY PLAN**

A. WHEREAS, in August 2014, the California Legislature passed, and in September 2014 the Governor signed, legislation creating the Sustainable Groundwater Management Act (“SGMA”) “to provide local groundwater sustainability agencies with the authority and technical and financial assistance necessary to sustainably manage groundwater” (Wat. Code, § 10720, (d)); and

B. WHEREAS, SGMA requires sustainable management through the development of groundwater sustainability plans (“GSPs”), which can be a single plan developed by one or more groundwater sustainability agency (“GSA”) or multiple coordinate plans within a basin or subbasin (Wat. Code, § 10727); and

C. WHEREAS, SGMA requires a GSA manage groundwater in all basins designated by the Department of Water Resources (“DWR”) as a medium or high priority, including the Sutter Subbasin (designated basin number 5-021.62); and

D. WHEREAS, BUTTE WATER DISTRICT elected to become a GSA, known as the BUTTE WATER DISTRICT GSA, on September 10, 2015 for the purposes of sustainably managing groundwater in the Sutter Subbasin, within its jurisdictional and GSA boundaries, pursuant to the requirements of SGMA; and

E. WHEREAS, the BUTTE WATER DISTRICT GSA has the authority to draft, adopt, and implement a GSP (Wat. Code, § 10725 *et seq.*); and

F. WHEREAS, the BUTTE WATER DISTRICT GSA is a member of the Sutter Subbasin Groundwater Management Coordination Committee formed for the purpose of developing a GSP and coordinating sustainable groundwater management in the Sutter Subbasin (Wat. Code, § 10723.6(i)); and

G. WHEREAS, Sutter County (“County”) submitted an Initial Notification to DWR on behalf of the members of the Sutter Subbasin to jointly develop a GSP for their respective portions of the Sutter Subbasin on May 29, 2020; and

H. WHEREAS, the BUTTE WATER DISTRICT has cooperated with all other GSAs in the Sutter Subbasin to draft a single GSP; and

I. WHEREAS, all the GSAs in the Sutter Subbasin have jointly developed the draft of the Sutter Subbasin GSP and released the draft Sutter Subbasin GSP for public comment on October 4, 2021;

J. WHEREAS, the GSAs comprising the Sutter Subbasin reviewed and considered comments on the Sutter Subbasin GSP; and

K. WHEREAS, on October 5, 2021, Sutter County released the Notice of Intent on behalf of all GSAs pursuant to Water Code § 10728.4; and

L. WHEREAS, on January 6, 2022 the GSAs in the Sutter Subbasin unanimously recommended each of its members adopt the final Sutter Subbasin GSP for their respective jurisdiction and GSA area; and

M. WHEREAS, the BUTTE WATER DISTRICT pursuant to Water Code section 10728.4 noticed and held a public hearing to receive comments on the Sutter Subbasin GSP.

NOW, THEREFORE, BE IT RESOLVED that the Board of Directors of the BUTTE WATER DISTRICT GSA finds as follows:

1. The above Recitals are true and correct and are incorporated herein as findings of the Board of Directors.
2. BUTTE WATER DISTRICT GSA hereby approves and adopts the Sutter Subbasin GSP as attached in Exhibit A.
3. Preparation and adoption of the Sutter Subbasin GSP through to this Resolution is not subject to the California Environmental Quality Act pursuant to Water Code section 10728.6.
4. BUTTE WATER DISTRICT GSA authorizes Sutter County, its consultants, and the Plan Manager to take such other actions as may be reasonably necessary to submit the Sutter GSP to DWR by January 31, 2022, and implement the purpose of this Resolution.

PASSED, APPROVED, AND ADOPTED this 13th day of January, 2022
by the following vote:

AYES: 4 Smith, Waller, Pantaleoni, Righero
NAYS: 0
ABSTAIN: 0
ABSENT: 1 Etcheverry



President of the Board

Attest:



Secretary to the Board

Date: 1/13/22



LIVE OAK CITY COUNCIL

REGULAR MEETING AGENDA JANUARY 19, 2022 6:00 PM

MEETING LOCATION
LIVE OAK COUNCIL CHAMBERS
9955 LIVE OAK BOULEVARD
LIVE OAK, CALIFORNIA 95953

MEMBERS OF THE COUNCIL

NANCY SANTANA, MAYOR
BOB WOTEN, VICE MAYOR
JERAMY CHAPDELAINE, COUNCILMEMBER
LAKHVIR GHAG, COUNCILMEMBER
J.R. THIARA, COUNCILMEMBER

AARON PALMER,
CITY MANAGER

NICOLE ROSSER,
CITY ATTORNEY

The Council may take up any agenda item at any time, regardless of the order listed. Action may be taken on any item on this agenda. Materials related to an item on this Agenda submitted to the Council after distribution of the agenda packet are available for public inspection at City Hall, 9955 Live Oak Boulevard, Live Oak, during normal business hours. Such documents are also available on the City of Live Oak's website at www.liveoakcity.org, subject to staff's availability to post the documents before the meeting.

In compliance with the Americans with Disabilities Act, the meeting room is wheelchair accessible and disabled parking is available. If you have a disability and need disability-related modifications or accommodations to participate in this meeting, please contact the City Clerk's office at (530) 695-2112 x107. Requests must be made at least 24 hours in advance.

Pursuant to Governor Newsom's Executive Orders N-25-20 and N-29-20, members of the Live Oak City Council or staff may participate in this meeting via a teleconference. In the interest of the maintaining appropriate social distancing, members of the public are encouraged to participate in the meeting in the following ways:

- **Remote Viewing:**

- *Members of the public can view a livestream of the meeting online at https://liveoakca.granicus.com/ViewPublisher.php?view_id=1.*
- *Members of the public can access the Zoom webinar as follows:*
 - **Join by Electronic Device:**
<https://us02web.zoom.us/j/87584004245>
 - **Join by Phone:**
1-669-900-6833 or 1-833-548-0282 (Toll Free)
Webinar ID: 875 8400 4245

- **Public Comment:** Members of the public can submit general public comments, as well as comment on specific agenda items in the following ways:
 - **Public Attendance:** Members of the public who attend in person may make comments from the Council Chamber podium.
 - **Live Remote Public Comment:** Members of the public can submit a live remote public comment by:
 - *Joining the virtual Council meeting via the link below. When public comment is opened, raise your virtual hand and be called upon to speak for up to 3 minutes.*

<https://us02web.zoom.us/j/87584004245>
 - *Joining the virtual Council meeting by calling the phone number below. When public comment is opened, dial *9 to raise your hand and be called upon to speak for up to 3 minutes.*

1-669-900-6833 or 1-833-548-0282 (Toll Free)
Webinar ID: 875 8400 4245
 - **Email Public Comment:** Comments from the public on agenda items will be accepted until 1:00 pm on the date of the meeting, via email to the City Clerk at cmenchaca@liveoakcity.org, and read into the record during public comment.
 - **eComment Feature:** Public Comment will be accepted online between Thursday, January 13th through Wednesday, January 19th at 1:00 pm through the eComment feature at: https://liveoakca.granicus.com/ViewPublisher.php?view_id=1.
-

CALL TO ORDER**ROLL CALL****PLEDGE OF ALLEGIANCE AND INVOCATION****CORRECTIONS AND/OR CHANGES TO THE AGENDA BY CITY MANAGER ONLY****PRESENTATIONS AND RECOGNITIONS**A. Holiday Lights Decorating Contest Winners**PUBLIC COMMENT**

Any person wishing to address the City Council on general jurisdictional matters or consent calendar items may do so at this time. If you are commenting on an agenda item, your comments will be heard at the time that item is scheduled for discussion. The City Council adopted a time limit of three minutes per person. The Brown Act does not allow for Council discussion of items not on the agenda. Councilmembers may only a) refer the matter to staff; b) ask for additional information; c) request a report back; or d) provide a limited factual response for items not listed on the agenda.

CONSENT ITEMS

Consent Calendar is passed by one motion with exceptions and separate votes as noted.

1. City Council Meeting Minutes
Recommendation: Approve the January 5, 2022 City Council Regular Meeting minutes.
(Clarissa Menchaca, City Clerk)
2. 2022 HOME Program Application Resolution
Recommendation: Adopt resolution authorizing the submittal of an application for HOME Grant Funds from the State Department of Housing and Community Development and the execution of agreements and documents necessary to participate in the HOME program.
(Alison Schmidt, Acting Chief Building Official)
3. Emergency Repair of Screening Unit at Wastewater Treatment Plant
Recommendation: Accept manufacturer's quote.
(Ron Walker, Public Works Director)

BUSINESS ITEMS

4. 2022 Council Member Committee Assignments
Recommendation: Approve the 2022 committee assignments as presented.
(Aaron Palmer, City Manager)
5. Council Discussion and Possible Action to Adopt a Resolution Approving and Adopting the Final Draft Sutter Subbasin Groundwater Sustainability Plan and Authorizing Submittal of the Final Draft Plan to the Department of Water Resources
Recommendation: Adopt resolution approving and adopting the final draft Sutter Subbasin Groundwater Sustainability Plan and authorizing submittal of the final draft plan to the Department of Water Resources.
(Scott Rolls, City Engineer)

6. Council Discussion and Possible Action to Adopt a Resolution Authorizing the Designation of Certain Products, Brands or Services and the Waiver of the Competitive Bidding Requirements for the Purchase of Standardized Equipment for Use in the Live Oak Streetscape Project
Recommendation: Adopt resolution authorizing the designation of certain products, brands or services and the waiver of the competitive bidding requirements for the purchase of standardized equipment for use in the Live Oak Streetscape Project.
(Scott Rolls, City Engineer)

ITEMS REMOVED FROM THE CONSENT AGENDA FOR COUNCIL CONSIDERATION AND ACTION

UPDATES AND ANNOUNCEMENTS FROM THE CITY ATTORNEY AND CITY MANAGER

COUNCILMEMBER COMMENTS (WRITTEN ONLY)

CLOSED SESSION

7. Conference with Labor Negotiators Pursuant to California Government Code Section 54957.6:
Agency Designated Representatives: Aaron Palmer, City Manager
Employee Organization: Confidential and Unrepresented Employees

ADJOURNMENT

RESOLUTION OF THE CITY COUNCIL OF THE CITY OF LIVE OAK ADOPTING THE SUTTER SUBBASIN GROUNDWATER SUSTAINABILITY PLAN

WHEREAS, in August 2014, the California Legislature passed, and in September 2014 the Governor signed, legislation creating the Sustainable Groundwater Management Act (“SGMA”) “to provide local groundwater sustainability agencies with the authority and technical and financial assistance necessary to sustainably manage groundwater” (Water Code, § 10720, (d)); and

WHEREAS, SGMA requires sustainable management through the development of groundwater sustainability plans (“GSPs”), which can be a single plan developed by one or more groundwater sustainability agency (“GSA”) or multiple coordinate plans within a basin or subbasin (Water Code, § 10727); and

WHEREAS, SGMA requires a GSA manage groundwater in all basins designated by the Department of Water Resources (“DWR”) as a medium or high priority, including the Sutter Subbasin (designated basin number 5-021.62); and

WHEREAS, City of Live Oak GSA was formed as a GSA on November 4, 2015, for the purposes of sustainably managing groundwater in the underlying subbasin, within its jurisdictional boundaries, pursuant to the requirements of SGMA; and

WHEREAS, City of Live Oak GSA is within the Sutter Subbasin (designated basin number 5-021.62); and

WHEREAS, City of Live Oak GSA has the authority to draft, adopt, and implement a GSP (Water Code, § 10725 et seq.); and

WHEREAS, the City of Live Oak GSA is a member of the Sutter Subbasin Groundwater Management Coordination Committee formed for the purpose of developing a GSP and coordinating sustainable groundwater management in the Sutter Subbasin (Water Code, § 10723.6); and

WHEREAS, Sutter County (“County”) submitted an Initial Notification to DWR on behalf of the Sutter Subbasin GSAs to jointly develop a GSP for their respective portions of the Sutter Subbasin on May 29, 2020; and

WHEREAS, the City of Live Oak GSA has coordinated with all other GSAs in the Sutter Subbasin to draft a single GSP for the subbasin; and

WHEREAS, all the GSAs overlying the Sutter Subbasin have jointly developed the draft of the Sutter Subbasin GSP (“Sutter GSP”) and released the draft Sutter GSP for public comment on October 4, 2021;

WHEREAS, the GSAs comprising the Sutter Subbasin Groundwater Management Coordination Committee reviewed comments on the Sutter GSP on behalf of its members; and

WHEREAS, on October 5, 2021, Sutter County released the Notice of Intent to Adopt a Groundwater Sustainability Plan on behalf of the Sutter Subbasin GSAs, pursuant to Water Code § 10728.4; and

WHEREAS, on January 6, 2022, the GSAs comprising the Sutter Subbasin Groundwater Management Coordination Committee recommended each of its members adopt the final draft Sutter GSP for their respective jurisdiction.

NOW, THEREFORE, BE IT RESOLVED that the City Council of the City of Live Oak finds as follows:

1. The City of Live Oak GSA hereby approves and adopts the final draft Sutter GSP, dated November 2021, incorporated herein by reference.
2. The City of Live Oak GSA authorizes Sutter County, its consultants, and the Plan Manager to take such other actions as may be reasonably necessary to submit the Sutter GSP to DWR by January 31, 2022 and implement the purpose of this Resolution.

PASSED AND ADOPTED by the City Council of the City of Live Oak this 19th day of January, 2022, by the following vote:

AYES: Councilmembers Thiara, Chapdelaine, Vice Mayor Woten, and Mayor Santana

NOES: None

ABSENT: Councilmember Ghag

NOT VOTING: None

APPROVED:



Nancy Santana, Mayor

ATTEST:



Luis Cibrian, Deputy City Clerk

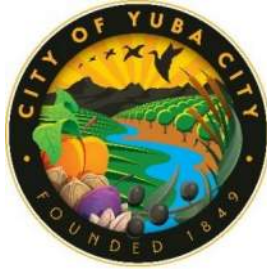

SPECIAL NOTICE

Precautions to address COVID-19 will apply to this meeting.

DECEMBER 21, 2021

REGULAR MEETING OF THE CITY COUNCIL

The Governor has declared a State of Emergency to exist in California as a result of the threat of COVID-19 (aka the "Coronavirus"). While the Governor recently issued Executive Orders N-07-21, which lifted certain orders and associated restrictions, there are still public health guidance's in place. The City is providing multiple alternatives to viewing Council meetings and providing comments on items on the agenda, including:

- **Web Conference:** The meeting will be conducted live over the internet by PC or Smartphone. Members of the public can join the web-based virtual meeting. (See instructions, below.)
- **Email:** You can email comments to cityclerk@yubacity.net any time before the meeting, or before the hearing is closed on the agenda item, and your comments will be read aloud. Please identify the Agenda item you wish to address in your comments.
- **Public Attendance:** Due to COVID-19, residents are encouraged to attend the City Council meeting via web conference or submit comments by email. Consistent with public health guidelines for social distancing, seating is available in the Council Chamber. A facial covering will be available upon request by any attendee. Comments may be made from the Council Chamber podium. Please participate via web conference or email if you are ill or have been exposed to COVID-19.

To join the web base virtual meeting please follow these instructions:

Click the link to sign up for the webinar at the specified time and date:

https://us06web.zoom.us/webinar/register/WN_DVqnnDjDSbm6ubr86NsjtA

You will need to register for the teleconference. Once registered, the following information will pop up.

Yuba City Council Meeting – 12/21/2021

Click here to [join the webinar](#).

Before joining, be sure to [check system requirements](#) to avoid any connection issues.

A confirmation email with information on how to join the webinar has been sent to you and with audio instructions. Questions or Comments? Email contact: cityclerk@yubacity.net

Note – currently the video conferencing process does not allow for verbal comments, but does have a chat function where comments will be read. Comments will also be received via email to cityclerk@yubacity.net.



AGENDA

DECEMBER 21, 2021

REGULAR MEETING
CITY COUNCIL
CITY OF YUBA CITY

5:00 P.M. CLOSED SESSION:
SUTTER ROOM/VIRTUAL

6:00 P.M. REGULAR MEETING
COUNCIL CHAMBERS/VIRTUAL

MAYOR	• Dave Shaw
VICE MAYOR	• Wade Kirchner
COUNCILMEMBER	• Marc Boomgaarden
COUNCILMEMBER	• Grace Espindola
COUNCILMEMBER	• Shon Harris
CITY MANAGER	• Diana Langley
CITY ATTORNEY	• Shannon L. Chaffin

1201 Civic Center Blvd
Yuba City CA 95993

Wheelchair Accessible



*If you need assistance in order to attend the City Council meeting, or if you require auxiliary aids or services, e.g., hearing aids or signing services to make a presentation to the City Council, the City is happy to assist you. Please contact City offices at (530) 822-4817 at least 72 hours in advance so such aids or services can be arranged. **City Hall TTY: 530-822-4732***

**AGENDA
REGULAR MEETING
CITY COUNCIL - CITY OF YUBA CITY
DECEMBER 21, 2021
5:00 P.M. CLOSED SESSION:
SUTTER ROOM/VIRTUAL

6:00 P.M. REGULAR MEETING
COUNCIL CHAMBERS/VIRTUAL**

Materials related to an item on this Agenda submitted to the Council after distribution of the agenda packet are available for public inspection in the City Clerk's office at 1201 Civic Center Blvd., Yuba City, during normal business hours. Such documents are also available on the City of Yuba City's website at www.yubacity.net, subject to staff's availability to post the documents before the meeting.

Public Comment:

Any member of the public wishing to address the City Council on any item listed on the closed session agenda will have an opportunity to present testimony to the City Council in the Council Chamber prior to the City Council convening into closed session. Comments from the public will be limited to three minutes. No member of the public will be allowed to be present once the City Council convenes into closed session.

Closed Session

1. **A. Threats to Public Services or Facilities (Pursuant to Government Code section 54957(a).) Consultation with: City Attorney, and/or Yuba City Fire Chief, Police Chief, Director of Public Works, IT Manager, and City Manager**

B. Conference With Legal Counsel—Anticipated Litigation Significant exposure to litigation pursuant to paragraph (2) of Government Code Section 54956.9(d): (One case)

C. Conference With Legal Counsel—Initiation of litigation pursuant to paragraph (4) of subdivision (d) of Section 54956.9: (One case)

Regular Meeting

Call to Order

Roll Call

- Mayor Shaw
- Vice Mayor Kirchner
- Councilmember Boomgaarden
- Councilmember Espindola
- Councilmember Harris

Invocation/Inspiration

Pledge of Allegiance to the Flag

Agenda Modifications/Approval of Agenda

Ceremonial Presentations

2. Economic Development Commissioners Recognition

3. Retirement Proclamation for Devin Barber, IT Manager - Special Projects

Public Communication

4. Appearance of Interested Citizens

You are welcome and encouraged to participate in this meeting. Public comment is taken on items listed on the agenda when they are called. Public comment on items not listed on the agenda will be considered at this time. Comments on controversial items may be limited and large groups are encouraged to select representatives to express the opinions of the group.

- **For Items on the Agenda**

Public comments on items on the agenda are taken during Council's consideration of each agenda item. If you wish to comment on any item appearing on the agenda, please note the number of the agenda item about which you wish to comment. If you wish to comment on more than one item, please send an email for each item.

- **Items not listed on the Agenda**

Public comments on items not listed on the agenda will be considered at this time. Members of the public submitting written requests at least 24 hours prior to the meeting will normally be allotted 5 minutes to comment. In addition to written comments, the public is welcome to submit a video presentation in electronic format to be played during public comment or during the hearing item. Due to COVID-19 staffing limitations, formatting, and video streaming related issues, presentations must be submitted to the City Clerk no later than 5:00 p.m. the day before the meeting to ensure the presentation is available for streaming at the time the Agenda item is called. Presentations submitted after 5:00 p.m. the day before the meeting may not be available to be streamed at the meeting.

Consent Calendar

All matters listed under Consent Calendar are considered to be routine and can be enacted in one motion. There will be no separate discussion of these items prior to the time that Council votes on the motion unless members of the City Council, staff or public request specific items to be discussed or removed from the Consent Calendar for individual action.

5. Minutes of the November 16, 23 and December 7, 2021

Recommendation: Approve the City Council minutes of November 16, 23 and December 7, 2021

6. Sutter Subbasin Groundwater Sustainability Plan Tentative Adoption

Recommendation: Adopt a Resolution to adopt the Sutter Subbasin Groundwater Sustainability Plan acting as the City of Yuba City Groundwater Sustainability Agency

7. Destruction of Specified Yuba City Police Department Records

Recommendation: Adopt a Resolution authorizing the Chief of Police to destroy specified Yuba City Police Department records which have exceeded their retention period, occupy valuable storage space and are of no further use to the City of Yuba City or Yuba City

Police Department

- 8. Submission of Recertification Application for Tree City USA Designation**
Recommendation: Adopt a Resolution authorizing the City to submit an application for recertification to the National Arbor Day Foundation for the City to continue its designation as a Tree City USA community
- 9. River Valley High School Striping and Marking Improvement Project (Plans & Specifications)**
Recommendation: Adopt a Resolution which adopts a CEQA Class 1 Categorical Exemption, approves the plans and specifications for the River Valley High School Striping and Marking Improvement Project, and authorizes Public Works staff to solicit quotes from qualified contractors to perform the work
- 10. 2021 Urban and Multibenefit Drought Relief Funding Grant Application**
Recommendation: Adopt a Resolution authorizing the grant application, acceptance, and execution for the Aquifer Storage Recovery System Project, and designate the Public Works Director or designee to execute any documents required for applying to the grant program and executing a funding agreement and related documents on behalf of the City
- 11. 2022 City Council Meeting Calendar**
Recommendation: Cancel the January 5th, May 3rd, and August 3rd 2022 Regular Council Meetings and provide for Special Workshops to be scheduled as needed
- 12. Appointments to City Council Regional Boards and Committees**
Recommendation: Approve the City Council Assignments to Regional Boards and Committees for Calendar Year 2022
- 13. Feasibility Study for Abandoned Railroad Corridor**
Recommendation: Adopt a Resolution which takes the following actions:

 1. Awards a Professional Services Agreement to Dokken Engineering of Folsom, CA for the Feasibility Study for Abandoned Railroad Corridor Project in the amount of \$224,169.50, subject to material terms, with the finding that it is in the best interest of the City
 2. Authorizes the Finance Director to accept grant funds into Account No. 301-43495 in the grant award amount of \$200,000
 3. Authorizes the Finance Director to make a supplemental appropriation in the amount of \$200,000 from Account No. 301-43495 to CIP Account No. 901282-65501
 4. Authorizes the Finance Director to make a supplemental appropriation in the amount of \$55,377.98 from unallocated Transportation Development Act funds to CIP Account No. 911282-65501
- 14. Monroe Road Sewer Improvements Award**

Recommendation: Adopt a Resolution approving a sole source justification and awarding a construction contract to Lund Construction Co. of North Highlands, CA in the amount of \$52,255.00 and authorizing the City Manager to execute a Standard Agreement on behalf of the City

15. Accept California Water and Wastewater Arrearage Payment Program financial assistance funding

Recommendation: Adopt a Resolution accepting the California Water and Wastewater Arrearage Payment Program benefits and authorize the Finance Director to make the necessary supplemental appropriations for related revenues and expenditures to 507-43481 and 7120-64103 for the 2021-22 fiscal year

16. Parcel Creation/Lot Line Adjustment – Harter Specific Plan

Recommendation: Adopt a Resolution authorizing the City Manager to execute a Grant Deed and associated documents, to create a new legal parcel for the future park on Harter Parkway, and participate in a Lot Line Adjustment to help facilitate development of the Harter Specific Plan for properties southerly of Butte House Road, westerly of Harter Parkway, and northerly of future Jefferson Avenue

17. National Opioid Settlement

Recommendation: A. Approve Settlement Participation Form for the City's participation in the National Opioid Settlement with McKesson Corporation, Cardinal Health, Inc., and AmerisourceBergen Corporation
B. Approve Settlement Participation Form for the City's participation in the National Opioid Settlement with Johnson & Johnson, Janssen Pharmaceuticals, Inc., Ortho-McNeil-Janssen Pharmaceuticals, Inc., and Janssen Pharmaceutica, Inc
C. Approve the California State-Subdivision Agreement Regarding Distribution and Use of Settlement Funds - Distributor Settlement
D. Approve the California State-Subdivision Agreement Regarding Distribution and Use of Settlement Funds - Janssen Settlement
E. Adopt a Resolution authorizing the City Manager to execute the documents identified in Recommendations A through D
F. Authorize the City Manager to carry out all necessary acts such that the City can participate in the National Opioid Settlements, including, but not limited to, the transmittal of the executed documents in Recommendations A through D (as necessary and applicable)

18. Annual Investment Policy Adoption

Recommendation: Approve Investment Policy as presented

19. CalPERS Employer Paid Member Contribution Resolutions

Recommendation: Adopt Resolutions for CalPERS to pay and report the value of Employer Paid Member Contributions for the Police Sworn Mid-Managers, Mid-Managers and Unrepresented Executive Team

20. Gauche Aquatic Park Verkada Camera System Upgrade (FB22-06)

Recommendation: Adopt a Resolution awarding the contract for the Gauche Aquatic Park Verkada Camera System upgrade to Gaynor Telesystems of Redding, CA in the total amount of \$65,085 plus a 10% contingency for a not to exceed amount of \$71,594 with the finding that it is in the best interest of the City

21. Purchase of four (4) Ford F-150 Police Responders (FB22-04)

Recommendation: Adopt a Resolution awarding the purchase of four (4) Ford F-150 Police Responder vehicles to Geweke Ford of Yuba City, CA, in the amount of \$166,444. Sole source the equipment purchase and install to Cop Shop Installations of Yuba City, CA in the estimated amount of \$157,363

22. Utility Payment Processing and Statement Printing and Mailing Proposal (RFP22-02)

Recommendation: Adopt a Resolution awarding the contract for utility payment processing, statement printing and mailing, bill presentment online, and IVR services to InfoSend, Inc. of Anaheim, CA with the finding that it is in the best interest of the City. The agreement will be in the estimated amount of \$141,400 for one (1) year with the option of four (4) one-year extensions. Authorize the City Manager to approve contract extensions

23. Yuba Sutter Salvation Army Professional Services Agreement - CDBG-CV Low-Income Mortgage Subsistence Program

Recommendation: Adopt a Resolution approving a Professional Services Agreement with Yuba Sutter Salvation Army for the 2020 Community Development Block Grant CARES Act (CDBG-CV) Low-Income Mortgage Subsistence Program

24. Finance Department Position Modifications

Recommendation: Adopt a Resolution approving the following changes to the Finance Department's positions in the FY 2021-22 Operating Budget:

1. Add an Administrative Analyst II and;
2. Reclassify a vacant Field Customer Service Representative I/II to Customer Service Representative I/II; and
3. Authorize a supplemental appropriation to the appropriate Finance Department salary and benefits accounts in the amount of \$45,200

25. Annual Report from the Downtown Yuba City Business Improvement District and Proposed Levy of Annual Assessment for 2022

Recommendation: A. Adopt a Resolution Accepting and Approving the 2021-2022 Annual Report of the Downtown Yuba City Business Improvement District

B. Adopt a Resolution of Intention to Levy and Collect 2022 Annual Assessments and set a Public Hearing for January 18, 2022

26. Blackburn Talley Field Lighting Phase III Project Award

Recommendation: A. Adopt a Resolution adopting a CEQA Class 1 Categorical Exemption; awarding a construction contract to Musco Sports Lighting, LLC in the amount of \$261,866 through Sourcewell Contract No. 071619-MSL, with the finding that it is in the best interest of the City; and authorizing the City Manager to execute an agreement for the Blackburn Talley Field Lighting Phase III project

B. Authorize the Finance Director to make a supplemental appropriation and related transfers in the amount of \$14,959.30 from unallocated general capital improvement project funds to CIP Account No. 901234-65501 for the additional funds necessary to complete construction

27. City of Yuba City Advisory Board Appointment List

Recommendation: Note and File the 2021 Local Appointment List and Direct Staff to post on the City's website

28. Sidewalk Maintenance and Repairs Ordinance

Recommendation: Adopt an Ordinance of the City Council of the City of Yuba City establishing sidewalk maintenance and repair responsibilities by adding Chapter 11 (Sidewalk Maintenance and Repairs) to Title 6 of the Yuba City Municipal Code by title only, and waive the second reading

Business Items

29. Homekey 2.0 Habitat for Humanity Presentation

Recommendation: Provide direction regarding the project application, as needed

30. Public Hearing No. 3 – Consideration of proposed maps for District voting divisions per California Elections Code Sections 10010(a)(2) and 10010(b)

Recommendation: A. Receive NDC's presentation of draft District voting division maps and the sequencings of division elections and public comments regarding the draft maps

B. Provide direction on preferred map(s) for additional analysis, revisions, or comment and possibly new maps

C. Provide comments on the sequencing of elections for the divisions to be established

D. Confirm the next public hearing for January 18, 2022

31. Yuba City Purchasing System Ordinance and Purchasing Policies Update

Recommendation: A. Introduce an Ordinance amending Chapter 6 (Purchasing System) of Title 2 of the Yuba City Municipal Code by title only, and waive the first reading

B. Adopt a Resolution adopting the Purchasing Policies and Procedures Manual Update (to become effective concurrently with the proposed ordinance)

32. Yuba City Wastewater Collection and Treatment Ordinance Update

Recommendation: Introduce an ordinance amending Chapter 5 (Wastewater Collection and Treatment) of Title 6 of the Yuba City Municipal Code by title only, and waive the first reading

33. Bridge Street Widening Project (21-01) – Plans & Specifications

Recommendation: Adopt a Resolution approving the plans and specifications for the Bridge Street Widening Project (21-01) and authorizing advertisement for bids on the project.

34. Harter Parkway Park Project Award

Recommendation: Adopt a Resolution which makes the following actions:

1. Awards a construction contract to Marina Landscape, Inc. of Orange, CA in the amount of their total bid \$2,507,985.49 and authorizes the City Manager to execute the contract on behalf of the City, subject to review and approval as to legal from by the City Attorney
2. Awards a construction contract to American Ramp Company, Inc. in the amount of \$227,401.57 through Sourcewell Contract No. 112420-ARC, with the finding that it is in the best interest of the City; and authorizes the City Manager to execute an agreement for the Bike Park project
3. Awards a contract for construction and inspection services to Coastland Civil Engineering, Inc. of Auburn, CA in the amount of \$141,850 and authorizes the City Manager to execute the contract on behalf of the City, subject to review and approval as to form by the City Attorney
4. Authorizes the Finance Director to make necessary appropriations from American Rescue Plan Act funds, in the amount of \$1,260,480.77 to CIP Account No. 941207-65501 (Harter Parkway Park and Bike Connection) in order to bridge the funding shortfall and ultimately fund the Park project

35. City Manager Employment Agreement

Recommendation: Adopt a Resolution Approving A City Manager Employment

Agreement between the City of Yuba City and Diana Langley,
Effective December 10, 2021 at 5:00 p.m.

Future Agenda Items

- 36. Future Agenda Items:**
- **Councilmember Boomgaarden**
 - **Councilmember Espindola**
 - **Councilmember Harris**
 - **Vice Mayor Kirchner**
 - **Mayor Shaw**

Reports and Communications

The following reports and communication items are provided for the Council's information. No action can be taken on items under this section unless the Council agrees to include it on a subsequent agenda

37. City Manager Report

38. City Council Reports

- Councilmember Boomgaarden
- Councilmember Espindola
- Councilmember Harris
- Vice Mayor Kirchner
- Mayor Shaw

Adjournment

RESOLUTION NO. 21-174

**RESOLUTION OF THE CITY COUNCIL OF THE CITY OF YUBA CITY ADOPTING
THE SUTTER SUBBASIN GROUNDWATER SUSTAINABILITY PLAN**

WHEREAS, the City of Yuba City recognizes the importance of regional groundwater sources for the environmental and economic stability of our City and the surrounding region; and

WHEREAS, the State of California adopted the legislation known collectively as the Sustainable Groundwater Management Act (the Act) in 2014 in order to facilitate sustainable management of groundwater basins statewide; and

WHEREAS, the Act requires all Groundwater Sustainability Agencies (GSAs) to develop and adopt a Groundwater Sustainability Plan (the Plan) in order to establish and ensure the sustainable groundwater management practices; and

WHEREAS, the City of Yuba City formally elected to become a GSA to represent the Sutter Subbasin within the limits of the City of Yuba City on March 21, 2017 in order to act as a stakeholder in the development and implementation of groundwater monitoring and management within the region; and

WHEREAS, the City of Yuba City entered into a Memorandum of Understanding and a Memorandum of Agreement with the other Sutter Subbasin GSAs on April 6, 2021 for the funding and development of the Plan; and

WHEREAS, the Sutter Subbasin GSAs have completed the development of the Plan and issued a Notice of Intention on October 5, 2021 regarding submittal of the proposed Plan to all cities and counties within the Sutter Subbasin to invite public comment. The required 90-day public comment period will conclude on January 3, 2022; and

WHEREAS, the Sutter Subbasin GSAs will submit the Plan to the California Department of Water Resources prior to January 31, 2022 for review and approval in accordance with the Act, upon the conclusion of the public comment period and the official adoption by the participating GSAs.

NOW, THEREFORE, be it resolved that the City Council of the City of Yuba City hereby adopts the "Sutter Subbasin Groundwater Sustainability Plan" as an official plan, acting as the City of Yuba City Groundwater Sustainability Agency, inclusive of any edits to the Plan as part of the public comment period and effective as of January 4, 2022.

The forgoing resolution was duly and regularly introduced, passed, and adopted by the City Council of the City of Yuba City at a regular meeting thereof held on the 21st day of December, 2021.

AYES: Councilmembers Boomgaarden, Espindola, Harris, Kirchner, and Mayor Shaw

NOES: None

ABSENT: None



Dave Shaw, Mayor

ATTEST:



Ciara Wakefield, Deputy City Clerk



APPROVED AS TO FORM
COUNSEL FOR YUBA CITY:



Shannon Chaffin, City Attorney
Aleshire & Wynder, LLP

*Reclamation District No. Seventy
PO Box 129 • Meridian, CA 95957
Office: (530) 696-2569
Fax: (530) 696-2551*

*Andy Duffey
Manager*

**AGENDA
BOARD OF TRUSTEES MEETING
1138 4th Ave
Meridian, CA 95957**

DATE: January 5, 2022

TIME: 9:30 AM

- 1. ROLL CALL AND CALL TO ORDER**
- 2. READING OF THE MINUTES OF THE PREVIOUS MEETINGS**
- 3. BUSINESS WITH LANDOWNERS OR GUESTS PRESENT**
- 4. OLD BUSINESS**
 - A. AT&T**
- 5. MANAGER'S REPORT**
- 6. FINANCIAL REPORT**
 - A. Review Bills**
- 7. NEW BUSINESS**
 - A. Resolution #2022-0105, Adopting the Sutter Subbasin Groundwater Sustainability Plan**
- 8. ADJOURN**
- 9. CLOSED SESSION (IF NEEDED)**

“Any documents related to agenda items that are made available to the board before the meeting will be available for review by the public at 1138 4th Street, Meridian, CA 95957.”

RESOLUTION NO. 2022-0105

**RESOLUTION ADOPTING THE SUTTER SUBBASIN GROUNDWATER
SUSTAINABILITY PLAN**

A. WHEREAS, in August 2014, the California Legislature passed, and in September 2014 the Governor signed, legislation creating the Sustainable Groundwater Management Act (“SGMA”) “to provide local groundwater sustainability agencies with the authority and technical and financial assistance necessary to sustainably manage groundwater” (Wat. Code, § 10720, (d)); and

B. WHEREAS, SGMA requires sustainable management through the development of groundwater sustainability plans (“GSPs”), which can be a single plan developed by one or more groundwater sustainability agency (“GSA”) or multiple coordinate plans within a basin or subbasin (Wat. Code, § 10727); and

C. WHEREAS, SGMA requires a GSA manage groundwater in all basins designated by the Department of Water Resources (“DWR”) as a medium or high priority, including the Sutter Subbasin (designated basin number 5-021.62); and

D. WHEREAS, Reclamation District No. 70 was formed as a GSA on May 3, 2017 for the purposes of sustainably managing groundwater in the Sutter Subbasin, within its jurisdictional boundaries, pursuant to the requirements of SGMA; and

E. WHEREAS, Reclamation District No. 70 has the authority to draft, adopt, and implement a GSP (Wat. Code, § 10725 *et seq.*); and

F. WHEREAS, the Reclamation District No. 70 is a member of the Sutter Subbasin Groundwater Management Coordination Committee formed for the purpose of developing a GSP and coordinating sustainable groundwater management in the Sutter Subbasin (Wat. Code, § 10723.6(i)); and

G. WHEREAS, Sutter County (“County”) submitted an Initial Notification to DWR on behalf of the members of the Sutter Subbasin to jointly develop a GSP for their respective portions of the Sutter Subbasin on May 29, 2020; and

H. WHEREAS, the Reclamation District No. 70 has coordinated with all other GSAs in the Sutter Subbasin to draft a single GSP for its members; and

I. WHEREAS, all the GSAs overlying the Sutter Subbasin have jointly developed the draft of the Sutter Subbasin GSP (“Sutter GSP”) and released the draft Sutter GSP for public comment on October 4, 2021;

J. WHEREAS, the GSAs comprising the Sutter Subbasin reviewed comments on the Sutter GSP on behalf of its members; and

K. WHEREAS, on October 5, 2021, Sutter County released the Notice of Intent on behalf of its members pursuant to Water Code § 10728.4; and

L. WHEREAS, on January 6, 2022 the GSAs comprising the Sutter Subbasin recommended each of its members adopt the final draft Sutter GSP for their respective jurisdiction.

NOW, THEREFORE, BE IT RESOLVED that the Board of Trustees of the Reclamation District No. 70 finds as follows:

1. Reclamation District No. 70 authorizes Sutter County, its consultants, and the Plan Manager to take such other actions as may be reasonably necessary to submit the Sutter GSP to DWR by January 31, 2022, and implement the purpose of this Resolution.

PASSED, APPROVED, AND ADOPTED this 5th day of January, 2022 by the following vote:

AYES: 4
NAYS: 0
ABSTAIN: 0
ABSENT: 1



Chairman

Attest:



Secretary

Date: 1-5-2022

RECLAMATION DISTRICT NO. 1500

P.O. Box 96

Robbins, CA 95676

November 25 2021

NOTICE OF BOARD MEETING AND AGENDA

A regular Board of Trustees Meeting has been scheduled for **Tuesday November 30, 2021**, at the district office in Kirkville, CA at 9:00 a.m. **This meeting will be held in person and via Zoom if you would like to participate by Zoom, please contact the office.**

Order of business;

1. Approval of Agenda and October, 2021, regular Board Meeting minutes.
2. Public Comment
3. Controller report
 - a. Review financial reports.
 - b. Signature to County Accounts – Interim GM Scott, Brad Mattson
 - c. Approval of Warrant-
 - d. Draw of LOC/Repayment
 - e. Audit 20-21
4. General Managers Report
 - a. Planning for Solar, Switchgear, PL84-99 repairs, Second Beach progress/options
 - b. Status of District Activities- Trash rack, Water Shed report Kevin Johannsen
 - c. BIDA Report-
 - d. Office/House Report
 - e. Drain Pumping/Dams
 - f. SGMA- GSP Planning- Resolution 2021-7
 - g. Election
 - h. Dry Year planning
 - i. 2021/2022 Winter Outlook
5. Report on field and O&M matters
 - a. Maintenance and Operations
6. Status of USACE Matters: PIR, LOI-SWIF
 - a. Status of LOI/SWIF
7. Status of Regional Flood Management Plan (RFMP)
8. DWR Matters
 - a. Review Tisdale/Sutter Bypass Comprehensive Management Plan
 - b. Status of Small Communities grant
 - c. FMAP and FSRP- 2022 program, Resolution 2021-8
9. Status of SGMA matters-Groundwater Transfer, Monitoring Wells
10. Update on CCVFCA activities.
11. Update on levee encroachments
12. Other Business

AUDIT COMMITTEE:

Bill Driver, Steve Butler

RESOLUTION NO. 2021-8

**RESOLUTION ADOPTING THE SUTTER SUBBASIN GROUNDWATER
SUSTAINABILITY PLAN**

A. WHEREAS, in August 2014, the California Legislature passed, and in September 2014 the Governor signed, legislation creating the Sustainable Groundwater Management Act (“SGMA”) “to provide local groundwater sustainability agencies with the authority and technical and financial assistance necessary to sustainably manage groundwater” (Wat. Code, § 10720, (d)); and

B. WHEREAS, SGMA requires sustainable management through the development of groundwater sustainability plans (“GSPs”), which can be a single plan developed by one or more groundwater sustainability agency (“GSA”) or multiple coordinate plans within a basin or subbasin (Wat. Code, § 10727); and

C. WHEREAS, SGMA requires a GSA manage groundwater in all basins designated by the Department of Water Resources (“DWR”) as a medium or high priority, including the Sutter Subbasin (designated basin number 5-021.62); and

D. WHEREAS, Reclamation District 1500 (RD 1500) was formed as a GSA for the purposes of sustainably managing groundwater in the Sutter Subbasin, within its jurisdictional boundaries, pursuant to the requirements of SGMA; and

E. WHEREAS, RD 1500 has the authority to draft, adopt, and implement a GSP (Wat. Code, § 10725 *et seq.*); and

F. WHEREAS, the RD 1500 is a member of the Sutter Subbasin Groundwater Management Coordination Committee formed for the purpose of developing a GSP and coordinating sustainable groundwater management in the Sutter Subbasin (Wat. Code, § 10723.6 (i)); and

G. WHEREAS, Sutter County (“County”) submitted an Initial Notification to DWR on behalf of the members of the Sutter Subbasin to jointly develop a GSP for their respective portions of the Sutter Subbasin on May 29, 2020; and

H. WHEREAS, the RD 1500 has coordinated with all other GSAs in the Sutter Subbasin to draft a single GSP for its members; and

I. WHEREAS, all the GSAs overlying the Sutter Subbasin have jointly developed the draft of the Sutter Subbasin GSP (“Sutter GSP”) and released the draft Sutter GSP for public comment on October 4, 2021;

J. WHEREAS, the GSAs comprising the Sutter Subbasin reviewed comments on the Sutter GSP on behalf of its members; and

K. WHEREAS, on October 5, 2021, Sutter County released the Notice of Intent on behalf of its members pursuant to Water Code § 10728.4; and

L. WHEREAS, on November 16, 2021 the GSAs comprising the Sutter Subbasin recommended each of its members adopt the final draft Sutter GSP for their respective jurisdiction.

NOW, THEREFORE, BE IT RESOLVED that the Board of Trustees of the RD 1500 finds as follows:

1. RD 1500 hereby approves and adopts the final draft Sutter GSP as attached in Exhibit A.
2. RD 1500 authorizes Sutter County, its consultants, and the Plan Manager to take such other actions as may be reasonably necessary to submit the Sutter GSP to DWR by January 31, 2022, and implement the purpose of this Resolution.

PASSED, APPROVED, AND ADOPTED this 30th day of November, 2021 by the following vote:

AYES: 4
NAYS: 0
ABSTAIN: 0
ABSENT: 3

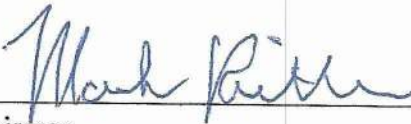

Chairman

Attest:



, Secretary

Date: 11-30-21

ATTACHMENT B

Local Maintaining Agency Authorizing Resolution
Resolution No. 2021-9

A Resolution by the Board of Trustees
of the Reclamation District No. 1500
Authorizing a Proposal for funding from the Department of Water Resources and Designating a
Representative to Execute the Agreement and any Amendments thereto, for the
2022-FMAP-RD1500-01 Project

WHEREAS, the Reclamation District No. 1500 is a California
Public Agency with responsibility for flood maintenance and right-of-way authority of the Project facilities;

WHEREAS the Reclamation District No. 1500 acknowledges
that it must submit a new operations, maintenance, repair, rehabilitation, and replacement agreement
with the Central Valley Flood Protection Board prior to the receipt of Flood Maintenance Assistance
Program funds;

WHEREAS, the Reclamation District No. 1500 is authorized to
enter into an agreement with the Department of Water Resources and the State of California;

THEREFORE, BE IT RESOLVED by the Board of Trustees
of the Reclamation District No. 1500 as follows:

1. That pursuant and subject to all of the terms and conditions of the Budget Act of 2021, the
Board of Trustees authorize the
General Manager, or designee, to execute the funding agreement
with the Department of Water Resources and any amendments thereto.
2. That the General Manager, or designee, shall prepare the necessary data,
make investigations, and take other such actions as necessary and appropriate to obtain funding
for the 2022-FMAP-RD1500-01 Project.

CERTIFICATION

I hereby certify that the foregoing Resolution No. 2021-9 was duly and regularly
adopted by the Board of Trustees of
the Reclamation District No. 1500 at the
meeting held on Nov 30, 2021, motion by Trustee Diner and
seconded by Trustee Alonso, motion passed by the following vote:

AYES: 4
NOES: 0
ABSTAIN: 0
ABSENT: 3

Attest: Mark Bester

Jon Scott
Jon Scott, General Manager
Reclamation District No. 1500

Board of Trustees
Chris Capaul, President
Robert Chesini
David Giampaoli
Jim Wallace
Mike Cole

Reclamation District No. Sixteen Sixty
PO Box 35 • Meridian, CA 95957
Office: (530) 696-0349
Fax: (530) 696-2551

Andy Duffey, Manager

BOARD OF TRUSTEES MEETING

TUESDAY

January 11, 2022
2:00 p.m.
6724 Progress Rd, Meridian

AGENDA

- 1) CALL TO ORDER AND ROLL CALL
- 2) READING OF THE MINUTES OF THE PREVIOUS BOARD MEETING HELD
- 3) BUSINESS WITH LANDOWNERS OR GUESTS
- 4) OLD BUSINESS
- 5) MANAGER'S REPORT
- 6) FINANCIAL REPORT OF THE DISTRICT
 - a) Review of the bills for the previous month
- 7) NEW BUSINESS
 - a) Resolution 2022-0111 Sutter Subbasin Groundwater Sustainability Plan
- 8) ADJOURN
- 9) CLOSED SESSION (IF NEEDED)

“Any documents related to agenda items that are made available to the board before the meeting will be made available for review by the public at 1138 4th Street, Meridian, CA 95957.”

RESOLUTION NO. 2022-0111

**RESOLUTION ADOPTING THE SUTTER SUBBASIN GROUNDWATER
SUSTAINABILITY PLAN**

A. WHEREAS, in August 2014, the California Legislature passed, and in September 2014 the Governor signed, legislation creating the Sustainable Groundwater Management Act (“SGMA”) “to provide local groundwater sustainability agencies with the authority and technical and financial assistance necessary to sustainably manage groundwater” (Wat. Code, § 10720, (d)); and

B. WHEREAS, SGMA requires sustainable management through the development of groundwater sustainability plans (“GSPs”), which can be a single plan developed by one or more groundwater sustainability agency (“GSA”) or multiple coordinate plans within a basin or subbasin (Wat. Code, § 10727); and

C. WHEREAS, SGMA requires a GSA manage groundwater in all basins designated by the Department of Water Resources (“DWR”) as a medium or high priority, including the Sutter Subbasin (designated basin number 5-021.62); and

D. WHEREAS, Reclamation District No. 1660 was formed as a GSA on May 9, 2017 for the purposes of sustainably managing groundwater in the Sutter Subbasin, within its jurisdictional boundaries, pursuant to the requirements of SGMA; and

E. WHEREAS, Reclamation District No. 1660 has the authority to draft, adopt, and implement a GSP (Wat. Code, § 10725 *et seq.*); and

F. WHEREAS, the Reclamation District No. 1660 is a member of the Sutter Subbasin Groundwater Management Coordination Committee formed for the purpose of developing a GSP and coordinating sustainable groundwater management in the Sutter Subbasin (Wat. Code, § 10723.6(i)); and

G. WHEREAS, Sutter County (“County”) submitted an Initial Notification to DWR on behalf of the members of the Sutter Subbasin to jointly develop a GSP for their respective portions of the Sutter Subbasin on May 29, 2020; and

H. WHEREAS, the Reclamation District No. 1660 has coordinated with all other GSAs in the Sutter Subbasin to draft a single GSP for its members; and

I. WHEREAS, all the GSAs overlying the Sutter Subbasin have jointly developed the draft of the Sutter Subbasin GSP (“Sutter GSP”) and released the draft Sutter GSP for public comment on October 4, 2021;

J. WHEREAS, the GSAs comprising the Sutter Subbasin reviewed comments on the Sutter GSP on behalf of its members; and

K. WHEREAS, on October 5, 2021, Sutter County released the Notice of Intent on behalf of its members pursuant to Water Code § 10728.4; and

L. WHEREAS, on January 6, 2022 the GSAs comprising the Sutter Subbasin recommended each of its members adopt the final draft Sutter GSP for their respective jurisdiction.

NOW, THEREFORE, BE IT RESOLVED that the Board of Trustees of the Reclamation District No. 1660 finds as follows:

1. Reclamation District No. 1660 authorizes Sutter County, its consultants, and the Plan Manager to take such other actions as may be reasonably necessary to submit the Sutter GSP to DWR by January 31, 2022, and implement the purpose of this Resolution.

PASSED, APPROVED, AND ADOPTED this 11th day of January, 2022 by the following vote:

AYES: 5
NAYS: 0
ABSTAIN: 0
ABSENT: 0

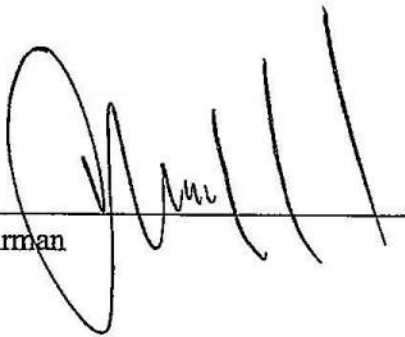
Chairman

Attest:

Secretary

Date: January 11, 2022

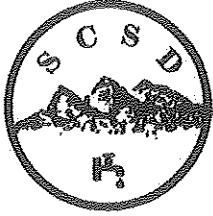

SUTTER COMMUNITY SERVICES DISTRICT

1880 ACACIA AVENUE
P.O. BOX 710
SUTTER, CALIFORNIA 95982-0710

PHONE (530) 755-1733

FAX (530) 755-1777

AGENDA

REGULAR MEETING

Monday January 3, 2022

6:30 P.M.

DAVID WILLIAMS, PRESIDENT
ANNETTE BABB, VICE PRESIDENT
JIM BARRINGER, DIRECTOR
JOEL FARIAS, JR., DIRECTOR
LARRY CRABTREE, DIRECTOR
Leland Correll, Board Secretary

I. CALL TO ORDER-QUORUM

A. Pledge of Allegiance

II. PUBLIC PARTICIPATION:

Persons wishing to address the Board during consideration of matters listed on the agenda will be allowed to do so. If you intend to speak on an issue, please submit a yellow Speakers Notice sheet to the Board Secretary. When the matter is announced, please stand and wait to be recognized by the President. Testimony should always begin with the speaker giving his or her name and place of residence. The Board requests that comments be limited to three (3) minutes.

DISABLED ACCOMMODATION: If you have a disability which requires an accommodation, an alternative format or requires another person to assist you while attending this meeting, please contact staff at the Sutter CSD office at (530) 755-1733 as soon as possible (no later than 4 days Before scheduled meeting) to ensure that arrangements for accommodation may be provided.

III. CORRESPONDENCE

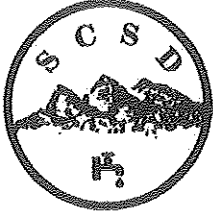

SUTTER COMMUNITY SERVICES DISTRICT

1880 ACACIA AVENUE
P.O. BOX 710
SUTTER, CALIFORNIA 95982-0710

PHONE (530) 755-1733

FAX (530) 755-1777

IV. CONSENT CALENDAR

- A. November 2021 Regular Meeting Minutes
- B. Nov & Dec 2021 Expenditures
- C. Nov & Dec 2021 Operators Report

V. MANAGERS REPORT:

- A. Ranch Sub Division

VI. DISCUSSION AND ACTION ITEMS

- A. Sutter Sub Basin / Sustainable Groundwater Management Resolution
- B. Gem Car
- C. Copy Machine
- D. Backhoe
- E. David Swartz

ADJOURNMENT: IN MEMORY OF Stephen DeWitt

RESOLUTION NO. 2022-01

**RESOLUTION ADOPTING THE SUTTER SUBBASIN GROUNDWATER
SUSTAINABILITY PLAN**

A. WHEREAS, in August 2014, the California Legislature passed, and in September 2014 the Governor signed, legislation creating the Sustainable Groundwater Management Act (“SGMA”) “to provide local groundwater sustainability agencies with the authority and technical and financial assistance necessary to sustainably manage groundwater” (Wat. Code, § 10720, (d)); and

B. WHEREAS, SGMA requires sustainable management through the development of groundwater sustainability plans (“GSPs”), which can be a single plan developed by one or more groundwater sustainability agency (“GSA”) or multiple coordinate plans within a basin or subbasin (Wat. Code, § 10727); and

C. WHEREAS, SGMA requires a GSA manage groundwater in all basins designated by the Department of Water Resources (“DWR”) as a medium or high priority, including the Sutter Subbasin (designated basin number 5-021.62); and

D. WHEREAS, SUTTER COMMUNITY SERVICES DISTRICT was formed as a GSA on Sept 14, 2015 for the purposes of sustainably managing groundwater in the Sutter Subbasin, within its jurisdictional boundaries, pursuant to the requirements of SGMA; and

E. WHEREAS, SUTTER COMMUNITY SERVICES DISTRICT has the authority to draft, adopt, and implement a GSP (Wat. Code, § 10725 *et seq.*); and

F. WHEREAS, the SUTTER COMMUNITY SERVICES DISTRICT is a member of the Sutter Subbasin Groundwater Management Coordination Committee formed for the purpose of developing a GSP and coordinating sustainable groundwater management in the Sutter Subbasin (Wat. Code, § 10723.6(i)); and

G. WHEREAS, Sutter County (“County”) submitted an Initial Notification to DWR on behalf of the members of the Sutter Subbasin to jointly develop a GSP for their respective portions of the Sutter Subbasin on May 29, 2020; and

H. WHEREAS, the SUTTER COMMUNITY SERVICE DISTRICT has coordinated with all other GSAs in the Sutter Subbasin to draft a single GSP for its members; and

I. WHEREAS, all the GSAs overlying the Sutter Subbasin have jointly developed the draft of the Sutter Subbasin GSP (“Sutter GSP”) and released the draft Sutter GSP for public comment on October 4, 2021;

J. WHEREAS, the GSAs comprising the Sutter Subbasin reviewed comments on the Sutter GSP on behalf of its members; and

K. WHEREAS, on OCTOBER 5, 2021, Sutter County released the Notice of Intent on behalf of its members pursuant to Water Code § 10728.4; and

NOW, THEREFORE, BE IT RESOLVED that the Board of Directors of the SUTTER COMMUNITY SERVICES DISTRICT finds as follows:

1. SUTTER COMMUNITY SERVICES DISTRICT hereby approves and adopts the final draft Sutter GSP as referenced.
2. SUTTER COMMUNITY SERVICES DISTRICT authorizes Sutter County, its consultants, and the Plan Manager to take such other actions as may be reasonably necessary to submit the Sutter GSP to DWR by January 31, 2022, and implement the purpose of this Resolution.

PASSED, APPROVED, AND ADOPTED this 3rd day of JANUARY, 2022 by the following vote:

AYES: 5
NAYS: 0
ABSTAIN: 0
ABSENT: 0

Chairman

Attest:

, Secretary

Date: 1/3/2022



AGENDA SUMMARY
SUTTER COUNTY
BOARD OF SUPERVISORS

Nicholas Micheli, District 1
Dan Flores, Chair, District 2
Mike Ziegenmeyer, Vice-Chair, District 3
Karm Bains, District 4
Mat Conant, District 5

The Agenda is posted in the entrance of the County Office Building at 1160 Civic Center Blvd., Yuba City.
The Agenda Summary, backup materials, and Approved Minutes are also posted on the Sutter County Website at:

<http://suttercountyca.igm2.com/Citizens/Default.aspx>

Materials related to an item on this Agenda submitted to the Board after distribution of the Agenda packet are available for public inspection in the office of the Clerk of the Board at 1160 Civic Center Blvd., Yuba City, during normal business hours.

January 25, 2022

11:00 A.M. SPECIAL MEETING
THE SOUTH GYM AT SUTTER UNION HIGH SCHOOL
2665 ACACIA AVENUE ❖ SUTTER, CA

Members of the public attending this meeting: After arriving at Sutter Union High School, please park in the rear parking lot and access the SOUTH GYM through the WEST DOOR

The Sutter County Board of Supervisor's meetings will be open to the public subject to social distancing requirements. Those that wish to attend the Board meeting are encouraged to wear a face covering as recommended by the California Department of Public Health (CDPH).

PROCEDURE FOR PUBLIC PARTICIPATION

Members of the Public will be allowed to address the Board with respect to the items listed on the Agenda only. The law requires that business not appearing on the Agenda may not be discussed at a special meeting. If you wish to speak on any item appearing on the Agenda, please fill out a Speaker Card, noting the number of the Agenda item about which you wish to speak, and present it to the Board Clerk. When the matter is announced, please approach the speakers' lectern after being recognized by the Chair.

11:00 AM SPECIAL MEETING/CALL TO ORDER

Roll Call
Invocation
Pledge of Allegiance

ELECTION OF CHAIR AND VICE-CHAIR FOR 2022

- a) Nominations for Chair
- b) Election of Chair
- c) Comments by incoming Chair
- d) Nominations for Vice-Chair
- e) Election of Vice-Chair
- f) Comments by incoming Vice-Chair

SPECIAL PRESENTATION

Presentation of a Certificate to Sutter High School Football Team in honor of winning the Northern Section Division III Championships

PUBLIC COMMENT

Members of the public will be allowed to address the Board on items of interest to the public that are within the subject matter jurisdiction of the Board of Supervisors. State law provides that no discussion or action may be taken on any item not appearing on the posted Agenda.

CONSENT AGENDA

The Consent Calendar groups together those items which are considered noncontroversial or for which prior policy direction has been given to staff and that require only routine action by the Board. The Chair will advise the audience that the matters may be adopted in total by one motion; however, the Board may, at its option or upon request of a member of the public, consider any matter separately.

Agricultural Commissioner

- 1) Authorization for the Sutter County Purchasing Agent to procure a new aerial photograph (survey) of Sutter County as a Software Capital Asset for the Agricultural Commissioner, and approval of the related adjustment to the Fiscal Year 2021-22 Adopted Budget in the amount of \$42,455 (4/5 vote required) (BTV2022051) (MT4110)

Board of Supervisors

- 2) Approval of the Board Committee Assignments for 2022 (MT4009)

Clerk of the Board

- 3) Approval of the Minutes of the Board of Supervisors January 11, 2022, Regular Session
- 4) Approval of the reappointment of Gabrielle Stadem to the Natomas Basin Conservancy Board of Directors for a three-year term ending December 31, 2024 (MT4121)

County Administrator

- 5) Approval of an adjustment to the Fiscal Year 2021-22 Adopted Budget in the amount of \$1,545,791 reflecting the re-budget of uncompleted projects/purchases that were included in the Fiscal Year 2020-21 Adopted Budget and its subsequent Board-approved amendments (4/5 vote required) (BTV Pending) (MT4001)

Development Services

- 6) Authorization to execute a Funding Letter of Agreement with the Placer County Transportation Planning Agency in the amount of \$20,000; and authorization for the Director of Development Services to execute and administer the agreement (MT4066)

Emergency Services

- 7) Authorization for the County Administrator's office to apply for, execute and administer the Fiscal Year 2020 Homeland Security Grant Program in the amount of \$175,009 and approval of an adjustment to the Fiscal Year 2021-22 Adopted Budget (2-401 Office of Emergency Management) to appropriate grant funds (4/5 vote required) (BTV pending) (MT4120)

Health and Human Services

- 8) Approval of the release of a Request for Proposal to solicit proposals for programs that reduce child abuse in the community, to be funded by Child Abuse Prevention, Intervention and Treatment; Community Based Child Abuse Prevention; and the County Children's Trust Fund (MT4112)
- 9) Approval of the Child Health and Disability Prevention Program, Health Care Program for Children in Foster Care, and California Children's Services Plan and Budget for Fiscal Year 2021-22 (MT4118)
- 10) Approval to waive the requirement for a Request for a Proposal per the provisions of Sutter County Ordinance Code 16-050, and approval of an agreement with Wellpath, LLC for intensive

outpatient treatment and outpatient drug free services for Fiscal Year 2021-22 in the amount of \$100,000 (MT4097)

- 11) Approval of a Peer Support Participation Agreement with California Mental Health Services Authority for implementation of a Medi-Cal Peer Support Specialist Certification Program for Sutter-Yuba Behavioral Health (MT4104)

Human Resources

- 12) Approval of job description and salary recommendation for the new classification of Cooperative Education Specialist I (MT4124)
- 13) Approval to adjust salaries for the Confidential Unit to comply with minimum wage requirements and address internal salary relationship inequities, and approval of salary adjustments for Food Service Worker and Correctional Food Services Supervisor (MT4125)

Probation

- 14) Approval of an adjustment to the Fiscal Year 2021-22 Adopted Budget in the amount of \$110,000 for the purchase of fifteen Department of Justice-compliant encrypted radios for Community Corrections Partnership (CCP)-funded law enforcement positions using CCP Planning and Setup Funds (4/5 vote required) (BTV2022055) (MT4115)

Sheriff-Coroner

- 15) Approval of an adjustment to the Fiscal Year 2021-22 Adopted Budget in the amount of \$22,000 to purchase four portable Motorola Radios as capital asset equipment within Public Safety Fund 0015, Sheriff-Coroner Budget Unit 2-201 (4/5 vote required) (BTV 2022054) (MT4129)

PUBLIC HEARING

- 16) Public Hearing to consider an additional recording fee of two dollars (\$2), to be paid at the time of the recording of every real estate instrument, paper, or notice required or permitted by law to be recorded, for the purpose of funding a restrictive covenant program pursuant to the provision of Assembly Bill 1466, Chapter 359 – an act to amend sections of the Government Code relating to real property (MT4013)

APPEARANCE ITEMS

GUADALUPE RIVERA, SENIOR CIVIL ENGINEER

- 17) Approval of a construction contract with Twin Trees, Inc. dba Twin Builders, in the amount of \$245,595.11, for the 1160 Civic Center 2nd Floor Tenant Improvement Project, Project Number C191800001: authorization for the Director of Development Services to execute the contract; authorization for the Director of Development Services to execute change orders in an amount not to exceed \$24,550; and approval of an adjustment in the amount of \$124,000 to the Fiscal Year 2021-22 Adopted Budget, C191800001: 1160 ADA Phase II, in Fund 0016, Budget1800 (4/5 vote required) (BTV pending) (MT4123)
- 18) Adoption of a resolution approving and adopting the Groundwater Sustainability Plan for the Sutter Groundwater Subbasin (MT4126)

NEAL HAY, DIRECTOR OF DEVELOPMENT SERVICES

- 19) Authorization for the dedication of a portion of Pass Road in the memory of Christopher Steidlmeyer (MT4130)
- 20) Award an Independent Contractor Agreement to Wood Rodgers in the amount of \$400,643 for engineering and environmental services for temporary and permanent repairs to Pass Road between Bridge 18C-0111 (over Butte Slough) and the western levee of the Sutter Bypass; waive the requirement for a Request for Proposals for consultant selection under the provisions of Sutter County Ordinance Code 16-050; and authorization for the Director of Development Services to execute and administer all contract documents (MT4128)

- 21) Approval to purchase equipment from the Gilsizer County Drainage District in an amount not to exceed \$98,228; and approval of an adjustment to the Fiscal Year 2021-22 Adopted Budget in the same amount to account for the purchases in the Road Fund (3100) (BTV pending) (MT4095)
- 22) Approval to purchase replacement radar speed signs for 14 locations in an amount not to exceed \$65,000 (MT4122)

GINA ROWLAND, HUMAN RESOURCES DIRECTOR

- 23) Approval to reinstate the vacation accrual limit for County employees (MT4096)
- 24) Approval of a new Memorandum of Understanding with the Sutter County Professional Firefighters' Association for the period of January 1, 2020 through June 30, 2023 (MT4100)

STEVEN M. SMITH, COUNTY ADMINISTRATOR

- 25) Approval to waive competitive bidding requirement, approve purchase of a capital asset Type 1 Fire Engine in the County Service Area - F budget (Fund 0305), approval of an adjustment to the Fiscal Year 2021-22 Adopted Budget increasing appropriations in the amount of \$630,000 for the purchase offset by a reduction in the General Fund Appropriation for Contingency (9-900), and authorize the Auditor-Controller to issue prepayment for the capital asset in advance of delivery (4/5 vote required) (BTV pending) (MT4079)
- 26) Ratify the County Administrator's authorization of the purchase of \$65,000 in COVID-19 rapid antigen tests and approval of an adjustment to the Fiscal Year 2021-22 Adopted Budget for the American Rescue Plan Act program (Fund 0269, Dept. 4155) increasing revenue and appropriations in the amount of \$150,000 to allow for the future purchase of COVID-19 rapid antigen tests for the County and community (BTV pending) (MT4133)
- 27) Approval of a 1st Amendment to a Professional Services Agreement with The Lew Edwards Group for Consultant Services modifying the scope of services, extending the term to November 30, 2022, and increasing compensation not to exceed \$97,500 (MT4134)
- 28) Approval of a letter authorizing the Regional Waste Management Authority (RWMA) to apply for CalRecycle SB 1383 grants on behalf of the County of Sutter and authorization for the County Administrator to approve future similar actions for RWMA (MT4138)
- 29) Follow-up reports and announcements

CORRESPONDENCE

- 30) Receive the Monthly Sutter County Code Enforcement Activity Report through December 2021 (MT4127)

DISTRICT REPORTS - BOARD OF SUPERVISORS

BOARD CONSIDERATION OF SYMPATHY OR HONOR OF CERTAIN INDIVIDUALS AND AGENCIES

ADJOURNMENT

BOARD COMMITTEE ASSIGNMENTS

BOARD COMMITTEE ASSIGNMENTS JANUARY 24, 2022 – FEBRUARY 4, 2022				
Monday 1/24	Tuesday 1/25	Wednesday 1/26	Thursday 1/27	Friday 1/28
3:30 pm – AG, PP, & GG		6:00 pm – YS Arts Council	8:30 am – Public Works/Support Servs 3:30 pm – Food Bank Board	8:30 am – Juvenile Rehabilitation Committee
Monday 1/31	Tuesday 2/1	Wednesday 2/2	Thursday 2/3	Friday 2/4
4:00 pm – SASA	8:30 am – H&W Committee	12:15 pm – Regional Housing Authority		7:30 am – EDC Board of Directors

CURRENT BOARDS AND COMMISSIONS VACANCIES (FOR INFORMATIONAL PURPOSES ONLY)

- Agency on Aging/Area 4 – Commission Appointee, Governing Board
- Behavioral Health Advisory Board – Consumer Representative, Family Representative
- Child Care Planning Council
- Countywide Oversight Board
- Environmental Health Appeals Board – Public Representative, Environmental Health Specialist, Engineer, Contractor, Medical Doctor
- In-Home Supportive Services Advisory Committee – Current or Past Provider, Current or Past Users, Senior Advocate, Disabled Persons Advocate
- Live Oak Cemetery
- Natomas Basin Conservancy Board of Directors
- Sutter Cemetery District
- Sutter County Advisory Commission on Aging – At Large
- Sutter County Advisory Commission on Aging – District 1
- Sutter County Advisory Commission on Aging – District 2
- Sutter County Advisory Commission on Aging – District 3
- Sutter County Advisory Commission on Aging – District 4
- Sutter County Advisory Commission on Aging – District 5
- Sutter County Community Action Agency – Low-income
- Sutter County Fish and Game Advisory Commission – Alternate
- Sutter County Housing Appeals Board – At-Large, Architect, Building Official, Contractor, Engineer

Requests for assistive listening devices or other accommodations, such as interpretive services, should be made through the Clerk of the Board at (530) 822-7106. Requests should be made at least 72 hours prior to the meeting. Later requests will be accommodated.

**BEFORE THE BOARD OF SUPERVISORS
COUNTY OF SUTTER, STATE OF CALIFORNIA**

A RESOLUTION OF THE SUTTER COUNTY)
BOARD OF SUPERVISORS ADOPTING THE)
SUTTER SUBBASIN GROUNDWATER)
SUSTAINABILITY PLAN)

RESOLUTION NO. 22-005

A. **WHEREAS**, in August 2014, the California Legislature passed, and in September 2014 the Governor signed, legislation creating the Sustainable Groundwater Management Act (“SGMA”) “to provide local groundwater sustainability agencies with the authority and technical and financial assistance necessary to sustainably manage groundwater” (Wat. Code, § 10720, (d)); and

B. **WHEREAS**, SGMA requires sustainable management through the development of groundwater sustainability plans (“GSPs”), which can be a single plan developed by one or more groundwater sustainability agency (“GSA”) or multiple coordinate plans within a basin or subbasin (Wat. Code, § 10727); and

C. **WHEREAS**, SGMA requires a GSA manage groundwater in all basins designated by the Department of Water Resources (“DWR”) as a medium or high priority, including the Sutter Subbasin (designated basin number 5-021.62); and

D. **WHEREAS**, the Sutter County GSA was formed as a GSA on February 28, 2017, for the purposes of sustainably managing groundwater in the Sutter Subbasin, within its jurisdictional boundaries, pursuant to the requirements of SGMA; and

E. **WHEREAS**, the Sutter County GSA has the authority to draft, adopt, and implement a GSP (Wat. Code, § 10725 *et seq.*); and

F. **WHEREAS**, the Sutter County GSA is a member of the Sutter Subbasin Groundwater Management Coordination Committee formed for the purpose of developing a GSP and coordinating sustainable groundwater management in the Sutter Subbasin (Wat. Code, § 10723.6(i)); and

G. **WHEREAS**, Sutter County (“County”) submitted an Initial Notification to DWR on behalf of the members of the Sutter Subbasin to jointly develop a GSP for their respective portions of the Sutter Subbasin on May 29, 2020; and

H. **WHEREAS**, the Sutter County GSA has coordinated with all other GSAs in the Sutter Subbasin to draft a single GSP for its members; and

I. **WHEREAS**, all the GSAs overlying the Sutter Subbasin have jointly developed the draft of the Sutter Subbasin GSP (“Sutter GSP”) and released the draft Sutter GSP for public comment on October 4, 2021; and

J. **WHEREAS**, the GSAs comprising the Sutter Subbasin reviewed comments on the Sutter GSP on behalf of its members; and

K. **WHEREAS**, on October 5, 2021, Sutter County released the Notice of Intent on behalf of its members pursuant to Water Code § 10728.4; and

L. **WHEREAS**, on January 6, 2022, the GSAs comprising the Sutter Subbasin recommended each of its members adopt the final draft Sutter GSP for their respective jurisdiction.

NOW, THEREFORE, BE IT RESOLVED that the Board of Supervisors of the Sutter County GSA finds as follows:

1. Sutter County GSA hereby approves and adopts the final draft Sutter GSP.
2. Sutter County GSA authorizes Sutter County, its consultants, and the Plan Manager to take such other actions as may be reasonably necessary to submit the Sutter GSP to DWR by January 31, 2022, and implement the purpose of this Resolution.

PASSED AND ADOPTED by the Board of Supervisors of the County of Sutter, State of California, this 25th day of January, 2022, by the following vote:

AYES: Supervisors Micheli, Flores, Ziegenmeyer, Bains, and Conant

NOES: None

ABSENT: None

MIKE ZIEGENMEYER, CHAIR

ATTEST:
DONNA M. JOHNSTON, CLERK

By 
Deputy

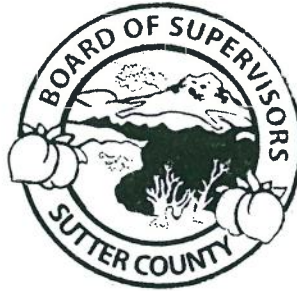

SUTTER EXTENSION WATER DISTRICT
BOARD OF DIRECTORS REGULAR MEETING
DECEMBER 21, 2021 AT THE HOUR 1:00 PM

THE SUTTER EXTENSION WATER DISTRICT BOARD OF DIRECTORS WILL MEET IN SPECIAL SESSION AT THE DISTRICT'S BOARD ROOM VIA TELECONFERENCE, LOCATED AT 4525 FRANKLIN ROAD, YUBA CITY.

Teleconference Access: 1(310) 372-7549

Conference Code: 520576

Please Take Notice, as a result of the COVID-19 pandemic, California Governor Gavin Newsom issued Executive Order (EO) N-29-20, which waives certain requirements of the Ralph M. Brown Act (Brown Act). Specifically: EO N-29-20 waives the requirements that local public agencies (1) notice each teleconference location from which a Board member will participate, (2) make each teleconference location accessible to the public, (3) allow the public to address the agency from each teleconference location, (4) post the agenda at each teleconference location, and (5) ensure that a quorum of the board participate in locations within the boundary of the agency. EO N-29-20 requires local public agencies that conduct public meetings telephonically to allow members of the public to observe and address the meeting telephonically or otherwise electronically.

In order to protect the health and safety of the public and District employees, District facilities, including the District Office located at 4525 Franklin Road, Yuba City, CA 95993, is closed to the public until further notice. In accordance with EO N-29-20, the public may participate in the District's December 21, 2021 special meeting by teleconference via the instructions provided above. Members of the public who observe the meeting via teleconference will be given the opportunity to provide public comment on the agenda item, and their comments will be included in the recording of the meeting.

AGENDA

1. Approval of November 9th, November 17th, December 3rd Meeting Minutes
2. Approval of Monthly Invoices
3. Public Participation
4. Consider Adoption of the Sutter Sub-basin Groundwater Sustainability Plan (Presentation by Leslie Dumas with Woodard and Curran)
5. Sunset Dam Removal Project Update
6. Looney Weir Modernization Project Update

7. SEWD Solar Project Update
8. Sutter National Wildlife Refuge Water Supply Study
9. 2022 Water Transfer
10. 2022 Water Season and Lake Oroville Operations Update
11. Consider Adoption of Resolution Regarding Teleconference Meetings
12. Directors Time
13. Adjournment

RESOLUTION NO. 2021-06

RESOLUTION ADOPTING THE SUTTER SUBBASIN GROUNDWATER SUSTAINABILITY PLAN

A. WHEREAS, in August 2014, the California Legislature passed, and in September 2014 the Governor signed, legislation creating the Sustainable Groundwater Management Act (“SGMA”) “to provide local groundwater sustainability agencies with the authority and technical and financial assistance necessary to sustainably manage groundwater” (Wat. Code, § 10720, (d)); and

B. WHEREAS, SGMA requires sustainable management through the development of groundwater sustainability plans (“GSPs”), which can be a single plan developed by one or more groundwater sustainability agency (“GSA”) or multiple coordinate plans within a basin or subbasin (Wat. Code, § 10727); and

C. WHEREAS, SGMA requires a GSA manage groundwater in all basins designated by the Department of Water Resources (“DWR”) as a medium or high priority, including the Sutter Subbasin (designated basin number 5-021.62); and

D. WHEREAS, Sutter Extension Water District Groundwater Sustainability Agency (SEWD-GSA) was formed as a GSA on September 24, 2015 for the purposes of sustainably managing groundwater in the Sutter Subbasin, within its jurisdictional boundaries, pursuant to the requirements of SGMA; and

E. WHEREAS, SEWD GSA has the authority to draft, adopt, and implement a GSP (Wat. Code, § 10725 *et seq.*); and

F. WHEREAS, the SEWD GSA is a member of the Sutter Subbasin Groundwater Management Coordination Committee formed for the purpose of developing a GSP and coordinating sustainable groundwater management in the Sutter Subbasin (Wat. Code, § 10723.6 (i)); and

G. WHEREAS, Sutter County (“County”) submitted an Initial Notification to DWR on behalf of the members of the Sutter Subbasin to jointly develop a GSP for their respective portions of the Sutter Subbasin on May 29, 2020; and

H. WHEREAS, the SEWD GSA has coordinated with all other GSAs in the Sutter Subbasin to draft a single GSP for its members; and

I. WHEREAS, all the GSAs overlying the Sutter Subbasin have jointly developed the draft of the Sutter Subbasin GSP (“Sutter GSP”) and released the draft Sutter GSP for public comment on October 4, 2021;

J. WHEREAS, the GSAs comprising the Sutter Subbasin reviewed comments on the Sutter GSP on behalf of its members; and

K. WHEREAS, on October 5th, 2021, Sutter County released the Notice of Intent on behalf of its members pursuant to Water Code § 10728.4;

NOW, THEREFORE, BE IT RESOLVED that the Board of Directors of the SEWD GSA finds as follows:

1. SEWD GSA hereby approves and adopts the final draft Sutter GSP as referenced in attached Notice of Intent..
2. SEWD GSA authorizes Sutter County, its consultants, and the Plan Manager to take such other actions as may be reasonably necessary to submit the Sutter GSP to DWR by January 31, 2022, and implement the purpose of this Resolution.

PASSED, APPROVED, AND ADOPTED this 21st day of December, 2021 by the following vote:

AYES: 5
NAYS: 0
ABSTAIN: 0
ABSENT: 0

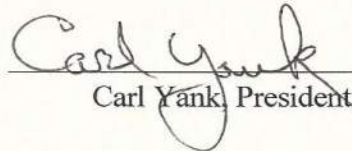

Carl Yank, President

Certification

I, Lynn Phillips hereby certify that I am and at all times mentioned herein was duly elected, qualified and acting Secretary of the Sutter Extension Water District organized and existing under and by virtue of the laws of the State of California, that the foregoing is a full, true and correct copy of a Resolution duly and regularly adopted at a meeting of the Board of Trustees of said District duly held on December 21, 2021, a majority and quorum of the members of said Board of Trustees being present and voting in favor of said Resolution; and that said Resolution has not been modified, rescinded, altered or amended and is now in full force and effect.



District Secretary

**Appendix 4-F
Responses to Stakeholder Surveys**

This page intentionally left blank.

Sustainability Plan - Stakeholder Input

5 responses

[Publish analytics](#)

Did you attend our first public workshop on December 14?

5 responses

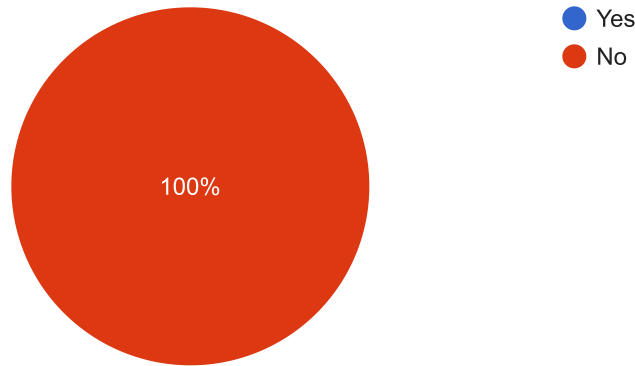

How did you hear about us?

5 responses

Employed by municipality within Sutter Subbasin

through my water association

email

city of live oak

online



Who do you represent?

5 responses

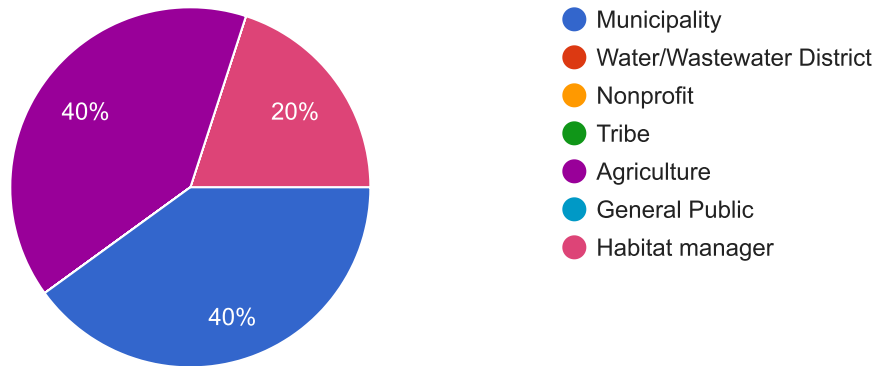

Are you familiar with the Sustainable Groundwater Management Act (SGMA) regulations?

5 responses

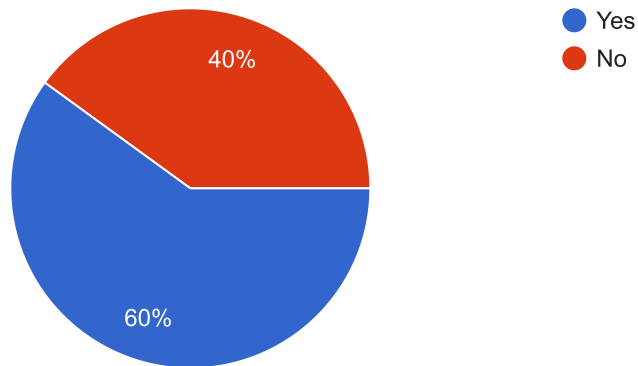

Are you currently engaged in activity or discussions regarding groundwater management in the region?

5 responses

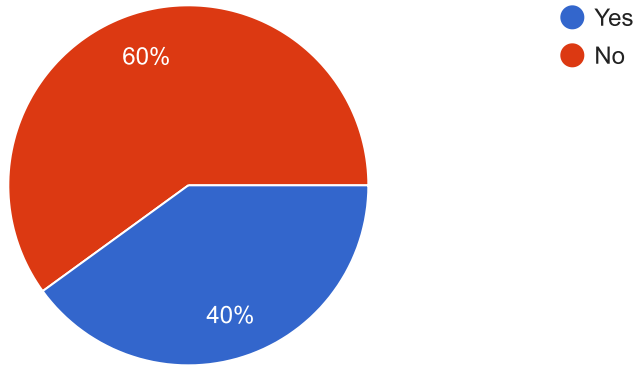

Do you own, manage, or operate land in this region?

5 responses

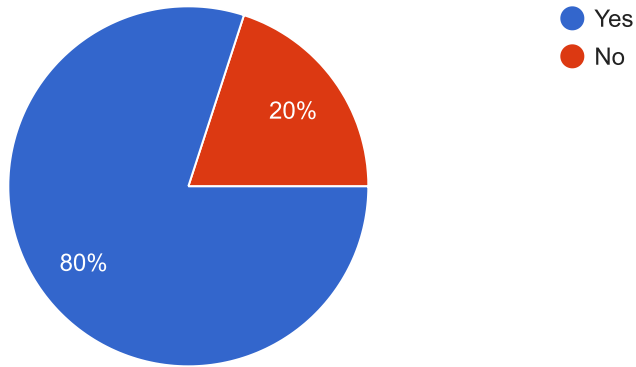

Do you manage water resources?

5 responses

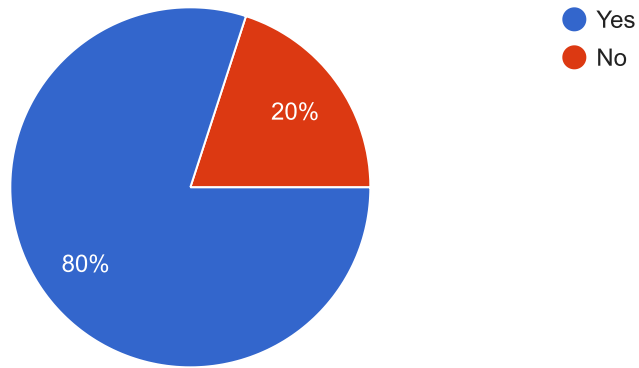

If you answered yes to the question above, what is your role?

4 responses

Stormwater Program Coordinator/Engineer

Land Manager

I irrigate 7 acres with a ground water pump

Farmer owner



What is your primary interest in land or water resources management?

5 responses

Increasing groundwater recharge to have as a resource during droughts affecting surface water supplies.

sustainable water for wildlife habitat

to be informed

investing in green solutions while building jobforce in live oak

Farming

Do you have concerns about groundwater management? If so, what are they?

5 responses

Agriculture activities causing pollution to groundwater supply and salt issues

concerned about overdraft

Yes, I don't want anyone to pump our ground water for sale to southern California

no concerns. lets start to build in live oak

That they will cut off my well water.



Do you have recommendations regarding groundwater management? If so, what are they?

3 responses

N/A

I want our ground water to be utilized to grow our crops

open up in city of live oak

What else do you want the planning team to know?

2 responses

Keep up the great work!

I feel monitoring of ground water levels is important in strategic areas of our county to determine long term trends of water table depths. I feel some volunteer growers could monitor their water tables end of August and report back to the ground water management team. I say grower volunteer instead of creating another commission to hire a person to measure water tables. In case of many drought years in a row and plunging water tables, crop restrictions would need to be advised to curtail water usage. Also fallow crop land where possible.

Please provide contact information of anyone else you think should be involved

0 responses

No responses yet for this question.

This content is neither created nor endorsed by Google. [Report Abuse](#) - [Terms of Service](#) - [Privacy Policy](#)

Google Forms



Sutter Subbasin GSP Project and Management Action Submittal Form

Please complete this form and email it to info@suttersubbasin.org

Overview

The purpose of this form is to gather ideas for potential projects and management actions (PMAs) that could be evaluated and ultimately included in the Sutter Subbasin Groundwater Sustainability Plan (GSP). An initial screening and evaluation process has been initiated and will be continued as suggested projects are submitted. Potential PMAs will be ranked for inclusion in the initial GSP.

Potential PMAs may fall under several categories, including but not limited to the following:

- Recharge projects
- Supply augmentation projects
- Water conservation projects
- Projects to reduce non-beneficial consumptive use
- Groundwater pumping allocations
- Monitoring programs (inter-basin flows, stream-aquifer interactions, groundwater pumping, water levels, etc.)
- Information collection and management (e.g., voluntary well registration program)

Please provide supporting documentation and/or links that documentation for each question, if available. NOTE: It is recognized that much of the requested information may not be available at this time; please do your best to supply what information is available at this time.

Project or Management Action Name and Contact

Project or Management Action Name:

Contact Person:

Organization/Affiliation:

Contact Phone:

Contact Email:

Project or Management Action Description and Status

Project or Management Action Name:

Project or Management Action Type:

Project or Management Action Proponent(s):

Project or Management Action Location:

Project or Management Action Status (Planned, Potential, or Conceptual):

Brief Project or Management Action Description (1-2 short paragraphs):

Measurable Objectives Expected to Benefit

Implementation Timing/ Criteria for Implementation:

Estimated Cost:

Potential Funding Sources:

Required Permitting and Regulatory Process:

Expected Yield (e.g. water contributed to the groundwater system, acre-feet per year):

Status of permitting and CEQA/NEPA compliance:

Does this Management Action or Project serve a disadvantaged community? If so, which one(s)?

Additional Information Sources:

Other:



Colusa Subbasin GSP Projects and Management Actions (PMAs) Submittal Form

Overview

The purpose of this form is to gather ideas for potential projects and management actions (PMAs) that could be evaluated and ultimately included in the Colusa Subbasin GSP. Once ideas are gathered, an initial screening and evaluation process will be conducted, followed by ranking of potential PMAs for more detailed evaluation and inclusion in the initial GSP.

Potential PMAs may fall under several categories, including but not limited to the following:

- Recharge projects
- Supply augmentation projects
- Water conservation projects
- Projects to reduce non-beneficial consumptive use
- Groundwater pumping allocations
- Monitoring programs (groundwater pumping, water levels, stream flows, etc.)

Please provide supporting documentation and/or links to that documentation for each question, if available. **NOTE: It is recognized that much of the requested information may not be available at this time. Please provide as much information as you can.**

Project Name and Contact

Project or Management Action Name: Springhorn Sutter Buttes and Willows Fault Arsenic and Salt Water Study

Contact Person: Ben King

Organization/Affiliation (Project Proponent): Stakeholder

Contact Phone: (530) 723-3119

Contact Email: bking@pacgoldag.com

Project or Management Action Description and Status

Project or Management Action Description: Colusa Groundwater Authority and Glenn Groundwater Authority should collaborate with counterparts in Butte, Sutter, Yuba and Yolo to request a USGS Study based on the recommended Future Work in Sections 6.0 to 6.3 of the Masters Thesis of Stephen Taylor Springhorn “ **Stratigraphic Analysis and Hydrogeologic Characterization of Cenozoic Strata in the Sacramento Valley Near the Sutter Buttes**” submitted April 22, 2008. The recommended Study and Study area should be extended into Glenn and Yolo Counties based on the presence of the Willows Fault and the findings of the



potential of lateral movement of natural occurring contaminants like arsenic and connate sea water via faults as described in the USGS Paper 1358 “ **Water Quality in Basin-Fill Aquifers of the Southwestern United States: Arizona, California, Nevada, New Mexico and Utah, 1993-2009**”. Springhorns recommended study should be expanded and supplemented since this publication was published in 2014.

Project or Management Action Location (please provide a map if available): See (A) Fault Activity Map of California regarding the location of the Willows Fault near the City of Colusa and the Colusa Rancheria from the California Geological Survey and (B) Figure 6.1 from Springhorn “Areas where subsurface information is needed”

Which Sustainability Indicator(s) does this Project or Management Action address
Groundwater Quality

Project or Management Action Status (Conceptual, In Design, Ready for Implementation): Springhorn has identified specific Management Actions in his “Future Work” to address Data Gaps. The USGS Paper 1358 has documented the lateral movement of natural occurring contaminants via faults like the Willows Fault and the predicted presence and movement of arsenic in aquifers with high pH salt water and volcanic rock formations such as the Sutter Buttes geologic formation. The Boards of the Colusa, Glenn, Butte, Sutter, Yuba and Yolo groundwater sustainability agencies should seek the input of the DWR, SWRCB, USGS and the USEPA to find consensus on the scope of the study.

Has a feasibility assessment been conducted? If so, please list the agency and provide the documentation (or provide web link to download). The USGS Paper 1358 highlights the similar work done in the Middle Rio Grande Basin regarding the arsenic contamination in Albuquerque New Mexico and the USGS has also done work in California regarding movement of natural occurring contaminants via faults.

Estimated Cost: \$ 1 million estimated unless offset by USGS.



Potential Funding Sources: USGS Budget – recommend that Congressmen Garamendi and LaMalfa be contacted for support of proposed Study.

Management Action or Project Yield (e.g. water contributed to the groundwater system, acre-feet per year): The safe conjunctive use of groundwater in the affected area will be protected since the aquifer ground water quality will be sustained.

Please describe any required Permitting and Regulatory Process and status of permitting and CEQA/NEPA compliance: None

Does this Management Action or Project serve a disadvantaged community? If so, which one(s)? Various SDAC areas in multiple counties and also potentially impacts the water quality for the Colusa Rancheria, the community supply systems of Princeton, Colusa, Grimes and various others in the several impacted Counties.

Additional Information Sources: Groundwater degradation was reported in the 1930s according the Sutter-Yuba Counties Investigation published by the SWRCB in September 1952. George Curtin discussed the presence of connate seawater near the Sutter Buttes in his 1971 Thesis “ Hydrogeology of the Sutter Basin, Sacramento Valley, California”

Other Information: Well Log from well located at the Colusa County Airport in Colusa showing “black sand” at 135 feet which is evidence of the extent of the Sutter Buttes Rampart under the City of Colusa. Also copy of SWRCB Compliance Order (No. 1-21-10) regarding an regulatory action for arsenic contamination in excess of the USEPA MCL on July 15, 2010 to highlight the presence of arsenic within the boundary of the City of Colusa. It is my understanding that this well was contaminated by arsenic and the nearby Del Oro Walnut Ranch well was abandoned.

MAP A

Fault Activity Map of California

California Geological Survey

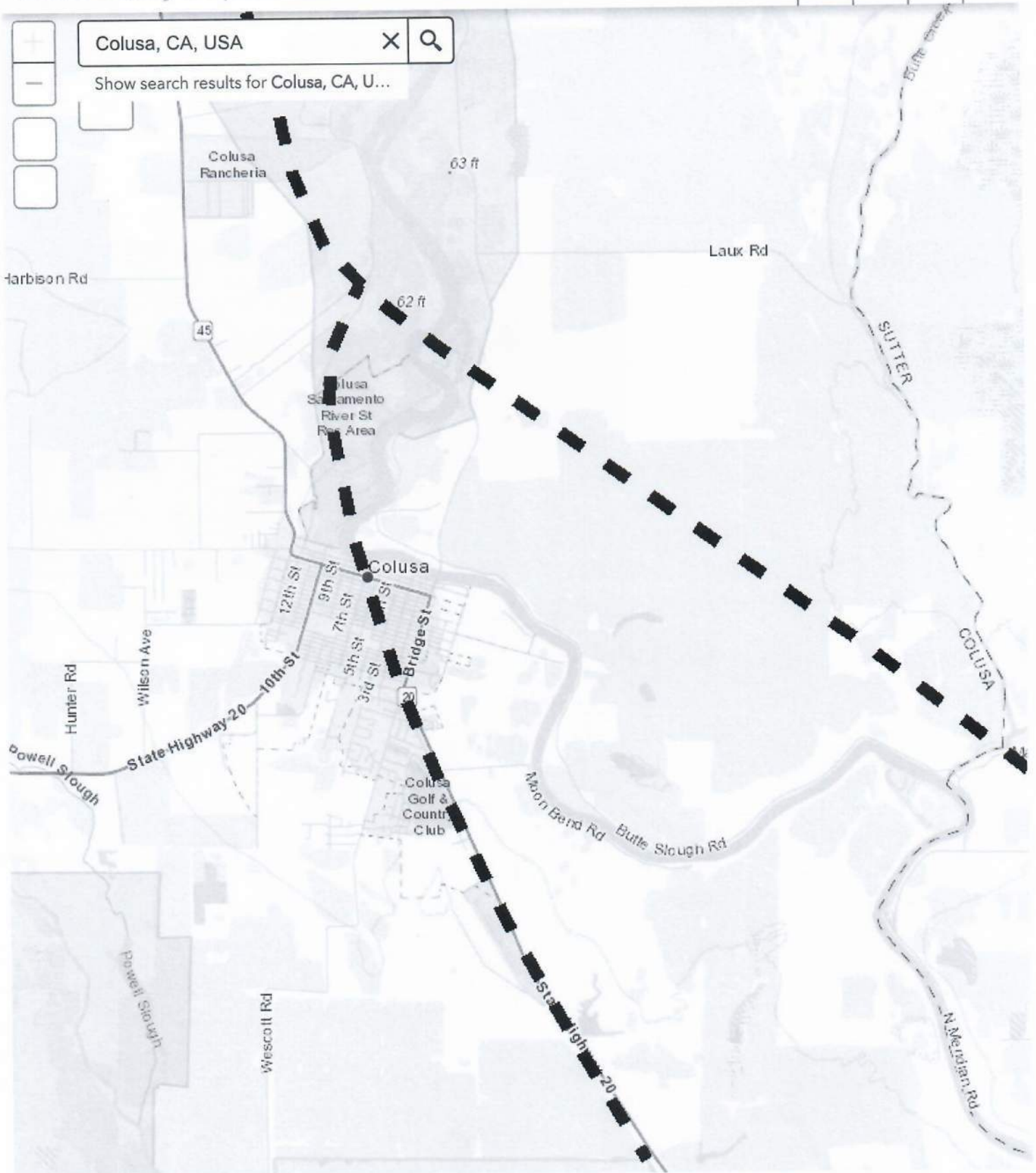

MAP B

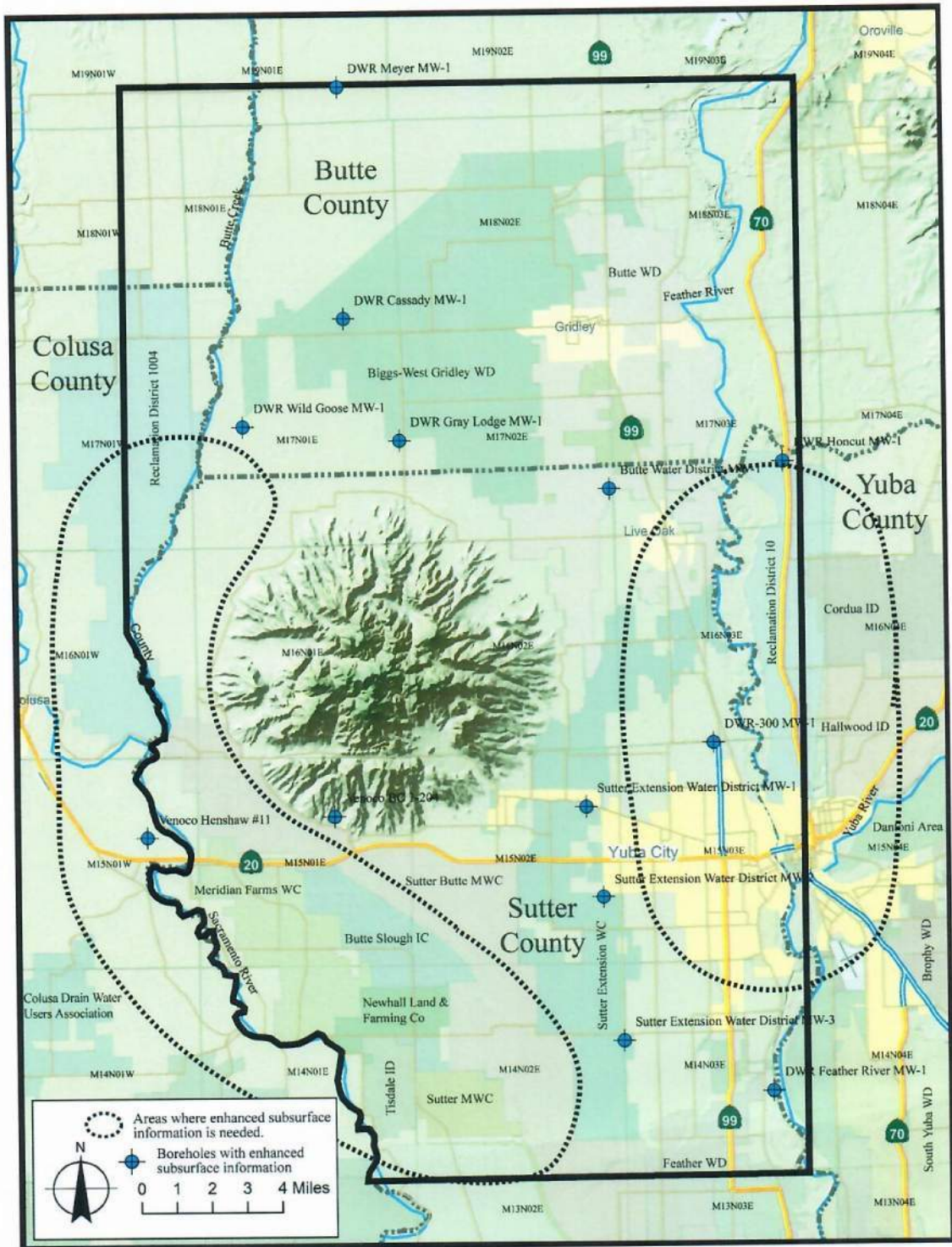

Figure 6.1: Areas where subsurface information is needed.

ATTACHMENT I

STRATIGRAPHIC ANALYSIS AND HYDROGEOLOGIC CHARACTERIZATION
OF CENOZOIC STRATA IN THE SACRAMENTO VALLEY NEAR THE SUTTER
BUTTES

Steven Taylor Springhorn
B.S., California State University, Chico, 2005

THESIS

Submitted in partial satisfaction of
the requirements for the degree of

MASTER OF SCIENCE

in

GEOLOGY

at

CALIFORNIA STATE UNIVERSITY, SACRAMENTO

SPRING
2008

Abstract
of
STRATIGRAPHIC ANALYSIS AND HYDROGEOLOGIC CHARACTERIZATION
OF CENOZOIC STRATA IN THE SACRAMENTO VALLEY NEAR THE SUTTER
BUTTES

by
Steven Taylor Springhorn

Stratigraphic and hydrogeologic characterization of Cenozoic strata in the central Sacramento Valley near the Sutter Buttes was completed to establish a conceptual understanding of the subsurface geology and hydrostratigraphy, and provide a foundation for future water resource investigations. The regional stratigraphy and stratigraphic nomenclature for Cenozoic deposits in the study area are synthesized, a subsurface stratigraphic framework is established, the subsurface extent and volume of the Sutter Buttes Rampart is estimated, and the thickness of the freshwater aquifer is delineated.

Subsurface interpretation was achieved by maximizing the use of existing datasets (drillers' logs, Division of Oil, Gas, and Geothermal Resources well files) and integration of new data (logs of recent Department of Water Resources wells) in the Valley. Nine stratigraphic units are defined and make up the stratigraphic framework of the central Sacramento Valley. The units, from oldest to youngest, are the Capay Formation, Ione Formation, Lovejoy Basalt, Sutter formation (containing the Valley Springs, Mehrten, and Tuscan Formations), Rhyolitic Rampart, Andesitic Rampart, Laguna Formation, Turlock Lake Formation, and Alluvial deposits (containing the Riverbank and Modesto

Formations). Distinctive subsurface characteristics of each stratigraphic unit were summarized to create a type log that was used for subsurface correlation.

Four regional geologic cross sections along with a chronostratigraphic framework chart illustrate the temporal, genetic, and stratigraphic relationships between the subsurface units, and provide insights into the paleogeography and basin evolution of the study area. The chronostratigraphic units identified suggest the depositional history of the central Sacramento Valley has been dominated by alluvial and fluvial processes from the late Tertiary through the Quaternary with a lacustrine environment during the middle Pleistocene as indicated by the Turlock Lake Formation, a diatomaceous clay interval (~25 feet average thickness) ranging from 0 to -150 feet mean sea level encountered in eleven recent boreholes distributed throughout the Sacramento Valley. In addition, dome eruptions and explosive magmatism occurred at the Sutter Buttes in the early Pleistocene.

A distinctive increase or baseline shift in the natural gamma ray signature coincides with the Sutter Buttes Rampart material in well logs. This distinctive signature enhances the subsurface characterization of the Rampart. The source of the high natural gamma ray values was determined, using the spectral gamma ray log, to be a pronounced increase in potassium and uranium, and a minor increase in thorium. These findings were substantiated by lithologic samples. Volcaniclastic material of the Rampart extends into the subsurface approximately 10 miles (16 km) to the north from the contact between the Rampart and the Sacramento Valley sediments, 5 miles (8 km) to the south, 4 miles (6 km) to the west near the Sacramento River, and 5 miles (8 km) to the east near the Feather River, and has an estimated minimum volume of 72 km³. The areal extent of the

Rampart is elongated to the north and slightly to the south while the areal extent is reduced on the east and west suggesting truncation and reworking by fluvial processes. The coarse-grained nature and considerable subsurface extent of the Rampart forms a significant aquifer in this area. However, analyses of water quality samples collected in the study area suggest there is a connection between elevated arsenic concentrations in groundwater and the presence of Rampart volcanoclastic material. In stratigraphic units above and below the Rampart, arsenic concentrations in groundwater are generally less than 10 µg/l. In contrast, within Rampart material, arsenic concentrations in groundwater samples are found in much higher concentrations (10 to 370 µg/l). Concentrations of arsenic in 27 spatially and depth distributed water samples from DWR monitoring wells ranged from < 0.1 to 370 µg/l. Concentrations in 15 of the samples exceed the USEPA drinking water Maximum Contaminant Level (MCL) of 10 µg/l, and 92 percent of groundwater samples collected from monitoring wells screened in Rampart volcanoclastic material have arsenic concentrations exceeding the MCL.

Fresh groundwater occurs primarily in late Tertiary to Quaternary unconsolidated sediments that extend to depths ranging from 0 to greater than -2,000 feet mean sea level. The configuration of the base of fresh groundwater is an uneven surface that commonly reflects the underlying geologic structure of the Valley. The maximum depth of the base of fresh groundwater in the study area is just south of the Sutter Buttes (greater than -2,000 ft. msl). The occurrence of freshwater at this depth may be produced by the combination of the structural complexity related to the uplift of the Buttes and the exposure of Eocene to Cretaceous units (Ione and Kione Formation) and subsequent

flushing of meteoric water through these units. On the west side of the study area the base of fresh groundwater reflects the underlying Colusa Buttes, which at the crest of this structure the Eocene-age Capay Formation is within 500 feet of the surface. The base of fresh groundwater boundary in the study area is consistently at or above the top of Eocene marine strata and is observed in Pliocene to Miocene continental deposits. This is likely caused by high artesian pressures and upward vertical gradients in deep aquifers in the Valley, which have been documented in deep (600-1,200 ft bgs) DWR monitoring wells. The brackish water in the lower part of aquifers near the base of fresh groundwater is classified as sodium-chloride (Na-Cl) water. The presence of brackish water in these deeper aquifers combined with upward vertical gradients creates the potential for continued upward migration of brackish water into overlying fresh water aquifers, or upconing beneath areas of pumping. Prolonged well pumping in these areas is likely to result in regional water quality degradation and may ultimately reduce the thickness of the fresh groundwater in Sacramento Valley aquifers.

Brian Hausback Committee Chair
Dr. Brian P. Hausback

April 22, 2008
Date

6.0 FUTURE WORK

This study has focused on maximizing the use of existing data and integration of new data to generate a stratigraphic framework of the Valley and improve the overall understanding of the aquifer system. Based on the information collected, a number of data gaps exist and future work is needed. In this section, additional data collection needs are identified including:

- Elevated arsenic concentrations in groundwater related to the Sutter Buttes Rampart material.
- Additional subsurface information is needed in several areas within the central Sacramento Valley.
- Sequence stratigraphic analysis.

These data collection needs are essential to better understand the groundwater resources in the Sacramento Valley near the Sutter Buttes. These additional data will improve knowledge of the basin hydrogeology and significantly enhance the ability of water managers to cooperatively manage the shared resources in a manner that is economically and environmentally sustainable.

6.1 Elevated Arsenic Concentrations in Groundwater Related to Sutter Buttes Rampart Material

Data analyses suggest there is a connection between elevated arsenic concentrations in groundwater and the presence of the Sutter Buttes Rampart volcaniclastic material (which is derived from silicic and intermediate volcanic rocks). In stratigraphic units that occur above and below the Rampart, arsenic concentrations in

groundwater are generally less than 10 $\mu\text{g/l}$ (micrograms/liter). In contrast, within Rampart material, arsenic concentrations in groundwater are found in much higher concentrations (10 to 370 $\mu\text{g/l}$).

Concentrations of arsenic in 27 spatially and depth distributed samples from DWR multi-completion monitoring wells ranged from < 0.1 to 370 $\mu\text{g/l}$. Concentrations in 15 of the samples exceeded the USEPA current drinking water Maximum Contaminant Level (MCL) of 10 $\mu\text{g/l}$, and 90 percent of groundwater samples collected from monitoring wells screened in Rampart volcanoclastic material have arsenic concentrations exceeding the MCL.

A detailed geochemical analysis of the relationship between elevated arsenic concentrations and Sutter Buttes Rampart material is needed, because of the health risks associated with this constituent. If a strong link is found between arsenic in groundwater and Rampart volcanoclastic material, the subsurface distribution of the Rampart presented in this thesis can be used in future geochemical investigations to delineate areas that have a high probability of containing elevated arsenic concentrations.

6.2 Location of Data Gaps and Additional Subsurface Data Needed

A significant amount of geologic, geophysical, and hydrogeologic data has been collected to date in the study area; however, there are many areas in the central Sacramento Valley that would benefit from additional geologic, geophysical, and dedicated groundwater monitoring data. These areas include (Figure 6.1):

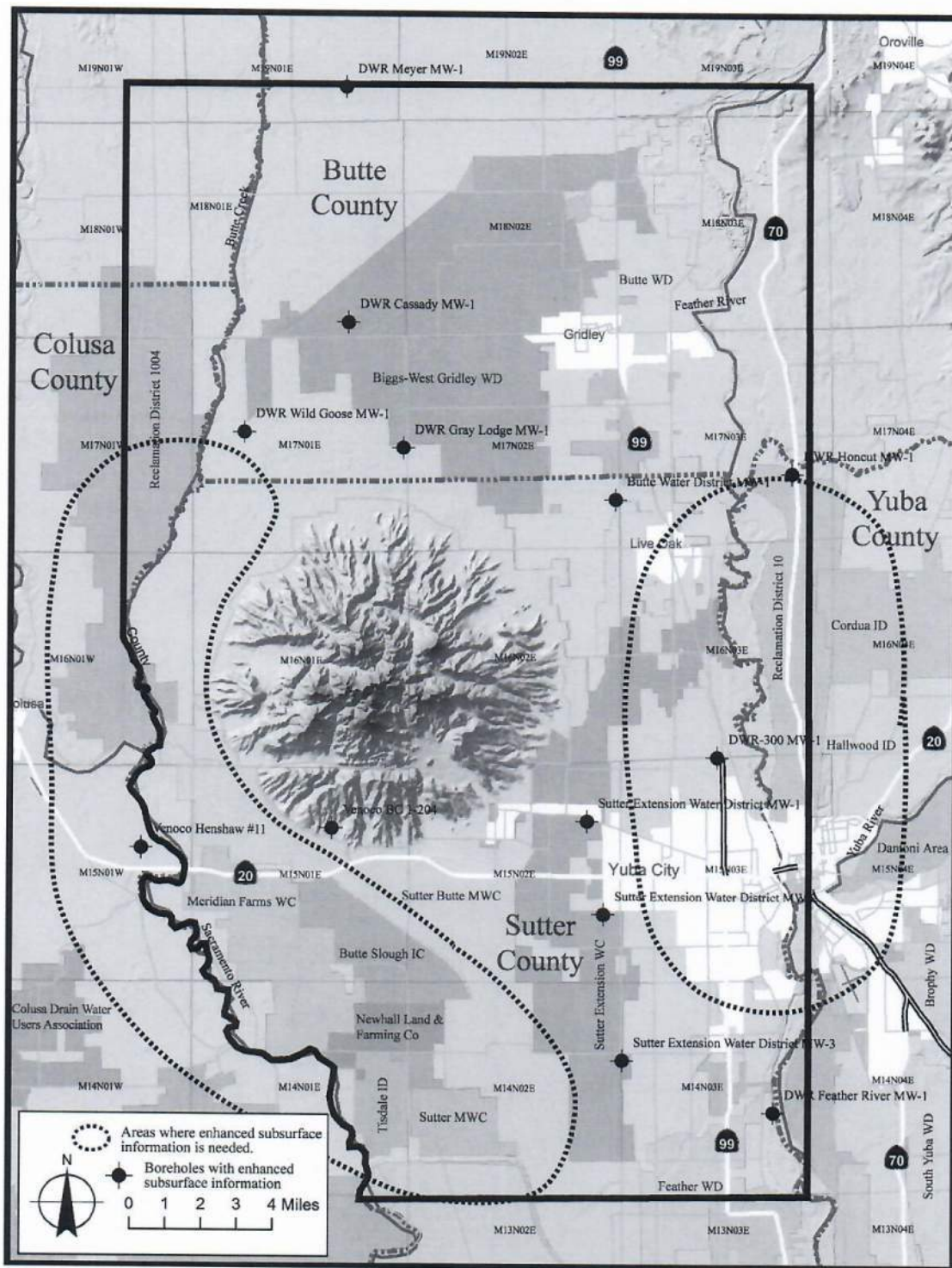

Figure 6.1: Areas where subsurface information is needed.

- East of the Sutter Buttes near the Feather River (between Live Oak and Marysville/Yuba City): The BFW appears to be significantly shallower in depth than the regional BFW trend. However, there is only one monitoring well in the area that has penetrated the BFW. Additional deep boreholes need to be installed to understand the hydrogeology and confirm the shallow BFW in this area because the majority of the local population is located here, and future development will likely increase groundwater demand.
- South and west of the Sutter Buttes: The subsurface geology and hydrogeology in these areas are poorly understood, due to the lack of boreholes and monitoring wells. Important features that may impact groundwater availability and water quality within these areas include deformation associated with the buried Colusa Dome (shallow BFW) and the subsurface extent of the Sutter Buttes Rampart.

Additional deep (1,000-2,000 ft) boreholes that penetrate the entire fresh water interval will help characterize the extent, distribution, and subsurface properties of aquifer materials in the Valley. Increased numbers of borings with subsurface information in the Valley will produce a higher resolution stratigraphic framework and understanding of the aquifer system.

Perhaps the most effective way to further the understanding of the Sacramento Valley aquifer system is to collect core samples in representative areas in the Valley for each fresh water bearing unit, and then log the core hole with an enhanced suite of borehole geophysics. The log signatures from the borehole geophysics can be correlated

directly with the lithologies observed in the core and can then be used to accurately interpret the many electric logs that are available from water wells and DOGGR well files in the Valley. With outcrop, core, and borehole geophysical data a higher resolution subsurface stratigraphy can be developed for the Valley. The lithology, thickness of beds, and the connectivity of the porous sandstone units are useful information for the development of a more accurate groundwater model for the Sacramento Valley.

Additional multiple-depth monitoring wells (in areas of identified data gaps) will help identify aquifer material, allow for measurement of vertical differences in hydraulic head, and quantify vertical changes in ground-water quality. Aquifer testing can be performed using the new wells as monitoring points, and aquifer parameters (transmissivity and storativity) can be quantified.

6.3 Sequence Stratigraphic Analysis

This study has established an initial stratigraphic framework and documented chronostratigraphically significant surfaces and marker-beds in the region. Once additional enhanced subsurface information is collected (borehole geophysics, core, and aquifer characteristics) the initial stratigraphic framework can be reevaluated using sequence stratigraphic principles. Sequence stratigraphy is a method of describing the aquifers and aquitards in the subsurface that relates the depositional environment of the sediments to the stratigraphic framework in which they were deposited. Sequence stratigraphy provides a tool for predicting the lateral and vertical extent of geologic units and the migration pathways of fluids (water, hydrocarbons, and contaminants) in the subsurface.

ATTACHMENT 2

ORIGINAL
File with DWR

WATER WELL DRILLERS REPORT

(Sections 7079, 7080, 7081, 7082, Water Code)

(Misc)
Do Not Fill In

CONFIDENTIAL LOG

No 12982

Water Code Sec. 13752

THE RESOURCES AGENCY OF CALIFORNIA
DEPARTMENT OF WATER RESOURCES

CONFIDENTIAL LOG
Water Code Sec. 13752

Well No. 15N/1W-56
Other Well No.

(1) OWNER:
Name Colusa County Airport
Address Colusa, Calif.

(2) LOCATION OF WELL:
County Colusa Owner's number, if any
Township, Range, and Section
Distance from cities, roads, railroads, etc.

(3) TYPE OF WORK (check):
New Well Deepening Reconditioning Destroying
If destruction, describe material and procedure in Item 11.

(4) PROPOSED USE (check):
Domestic Industrial Municipal
Irrigation Test Well Other

(5) EQUIPMENT:
Rotary
Cable
Other

(6) CASING INSTALLED:

STEEL:				OTHER:			
SINGLE		DOUBLE		SINGLE		DOUBLE	
From ft.	To ft.	Diam.	Gage or Wall	Diameter of Bore	From ft.	To ft.	
0	75	8"	12ga				

If gravel packed

Size of shoe or well ring: 2 1/2 x 18" Size of gravel:
Describe joint: B/W

(7) PERFORATIONS OR SCREEN:

From ft.	To ft.	Perf. per row	Rows per ft.	Size in. x in.

(8) CONSTRUCTION:
Was a surface sanitary seal provided? Yes No To what depth _____ ft.
Were any strata sealed against pollution? Yes No If yes, note depth of strata
From 0 ft. to 75 ft.
From _____ ft. to _____ ft.
Method of sealing Clay

(9) WATER LEVELS:
Depth at which water was first found, if known 20 ft.
Standing level before perforating, if known _____ ft.
Standing level after perforating and developing 20 ft.

(10) WELL TESTS:
Was pump test made? Yes No If yes, by whom?
_____ gal./min. with _____ ft. drawdown after _____ hrs.
Temperature of water _____ Was a chemical analysis made? Yes No
Was electric log made of well? Yes No If yes, attach copy

(11) WELL LOG:

Total depth	Depth of completed well
140 ft.	140 ft.
Formation: Describe by color, character, size of material, and structure	
0 ft. to 10	Top Soil ft.
10	30 Sandy musk
30	30 clay
30	50 Gravel & sand
50	55 yellow clay
55	72 sand & gravel
72	135 Blue clay
135	140 Black Sand



This Well is located at the Airport in Colusa.

Plotted and Coded

As Well 15N/1W-5680

Work started 8/19 1971, Completed 8/20 1971

WELL DRILLER'S STATEMENT:
This well was drilled under my jurisdiction and this report is true to the best of my knowledge and belief.

NAME Beaman & Son Pump Co.
(Person, firm, or corporation) (Typed or printed)
Address 470 S. Persh St. Colusa, Calif.
Beaman & Son Pump Co.
[SIGNED] D. J. Beaman
(Well Driller)

License No. 196093 Dated 9/24 1971

SKETCH LOCATION OF WELL ON REVERSE SIDE

JUL 14 1994 15N-1W-5G1 State No.

WELL DATA

DISTRICT Northern

Owner Colusa Co. Airport
Address Colusa 2915 Hwy. 20 - COLUSA
Tenant Caretaker: Connor Davis
Address _____

State No. 15N/1W-5G1
Other No. _____

Type of Well: Hydrograph Key Index Semiannual
Location: County Colusa Basin Colusa
U.S.G.S. Quad. Meridian Quad. No. 5456

Description @ the Colusa Co. Airport. SE 1/4 of Colusa on State Hwy 20 about 1 mile. Well is inside an aluminum clad P.H. 100' S/O NWV of 300' w/o gas pumps

Reference Point description Hole T.O.C.

which is 1.4 ft. above land surface. Ground Elevation 45.0 ft.

Reference Point Elev. 46.4 ft. Determined from Quad

Well: Use Industrial - Dem. Condition _____ Depth 146 ft.

Casing, size 8 in., perforations 0-75 USS, OPEN HOLE TO 140'

Measurements By: DWR USGS USBR County Irr. Dist. Water Dist. Cons. Dist.

Chief Aquifer: Name _____ Depth to Top Aq. _____ Depth to Bot. Aq. _____

Type of Material _____ Perm. Rating _____ Thickness _____

Gravel Packed? Yes No Depth to Top Gr. _____ Depth to Bot. Gr. _____

Supp. Aquifer _____ Depth to Top Aq. _____ Depth to Bot. Aq. _____

Driller Beamer & Son Pump Co.

Date drilled 8/20/71 Log, filed #12982 open (1) _____ confidential (2) 12982

Equipment: Pump, type Sub make _____

Serial No. _____ Size of discharge pipe _____ in.

Power, Kind _____ Make _____

H. P. _____ Motor Serial No. _____

Elec. Meter No. _____ Transformer No. _____

Yield _____ G.P.M. Pumping level _____ ft.

Water Analysis: Min. (1) _____ San. (2) _____ H.M. (3) _____

Water Levels available: Yes (1) 2 No _____

Period of Record: Begin 10-21-75 End ACTIVE

Collecting Agency: _____

Prod. Rec. (1) _____ Pump Test (2) _____ Yield (3) _____

SKETCH



REMARKS

On 11-28-01 I SURVEYED IN A ACCURATE ELEV. TO THE R.P. FROM USGS B.M. THE R.P. WELL CASING HAD BEEN EXTENDED IN FALL OF 2000. NO ACCURATE RECORD OF THE EXTENSION WAS MADE SO I DID THIS. EWH

WELL MEASUREMENT QUALIFICATION
By: T. FORENS No. 3666 Date 6/11/99

Qualification COMPOSITE Semi-Confined

Confidence DEFINITE

Water Body: FLOODPLAIN DEPOSITS & older Basin Deposits

Recorded by: J. Bonemilli

Date June 1989

WILLIAMS 9.5 MI.
COLUSA 1.5 MI.

T. 16 N.
1562 II NE
(COLUSA)
T. 15 N.

4337

4336

10'

4335

4334

540 000
FEET

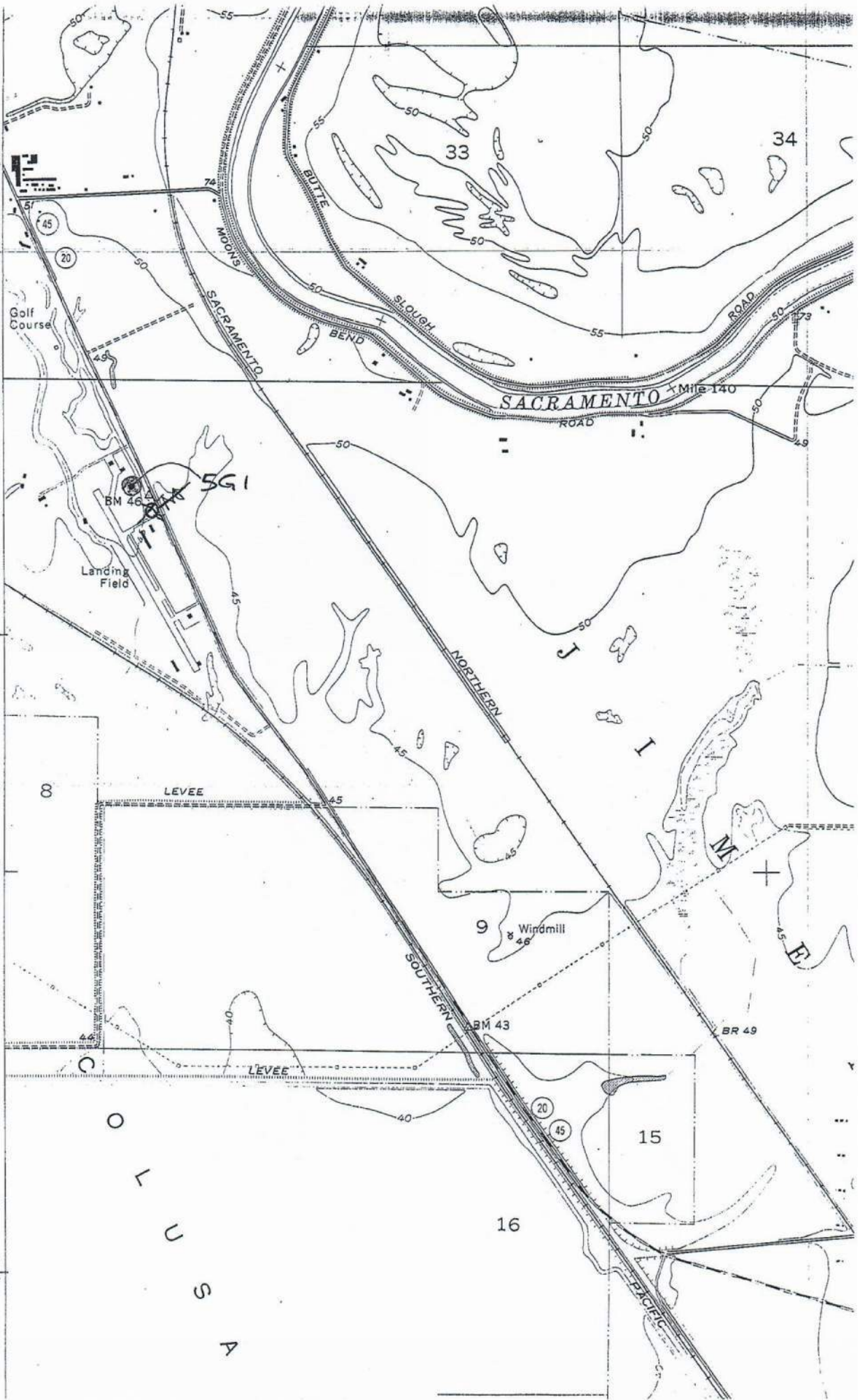

C
O
L
U
S
A

LEVEE

LEVEE

16

15

9

Windmill

BM 43

BR 49

BM 46

561

Landing Field

Golf Course

SACRAMENTO ROAD

Mile 140

SACRAMENTO

MONY'S

BUTTE

SLOUGH

BEND

34

33

I

M

E

J

K

L

N

O

P

Q

R

S

#12982

WATER WELL DRILLERS REPORT

FIELD WORK SHEET

Report No. 12982
Owner Colusa County Airport
Pump No. -
Meter No. -

LOCATION

Section 5G
Township 15N
Range 1W

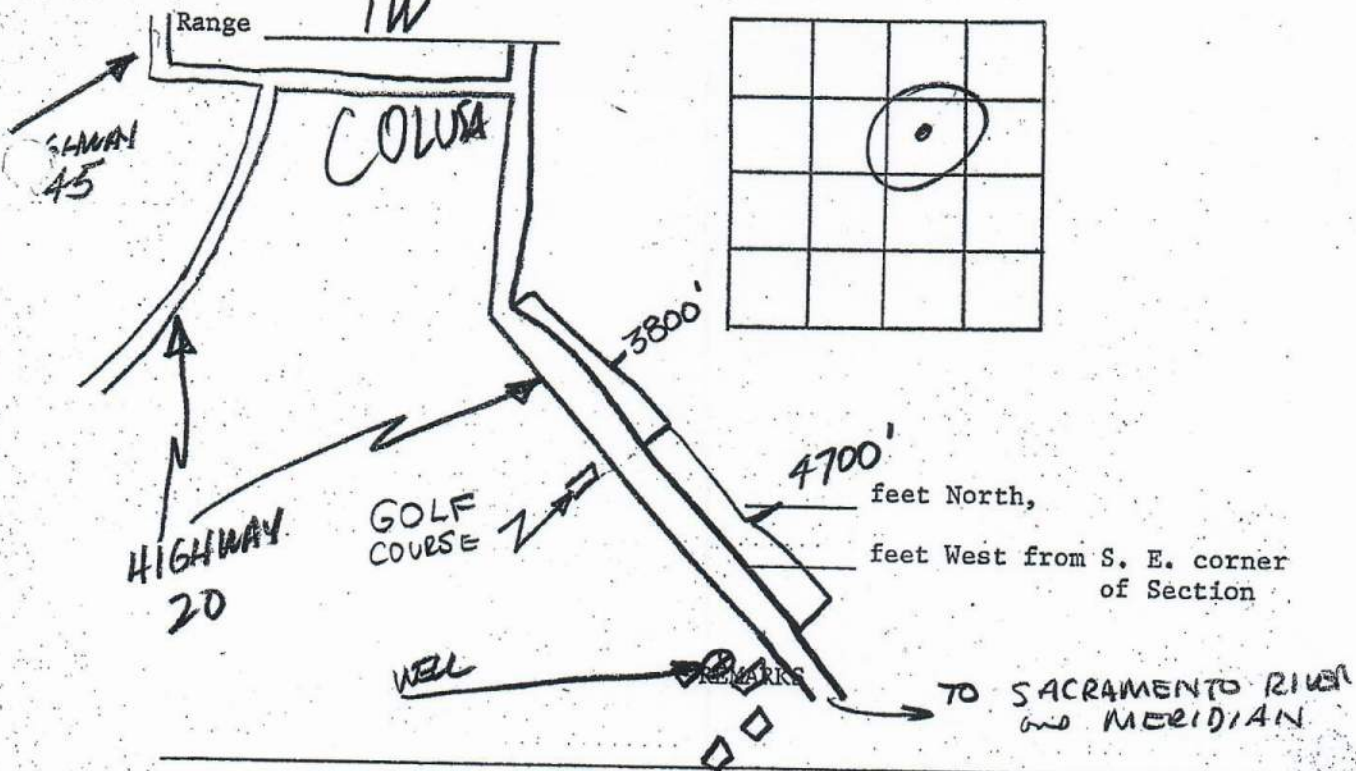
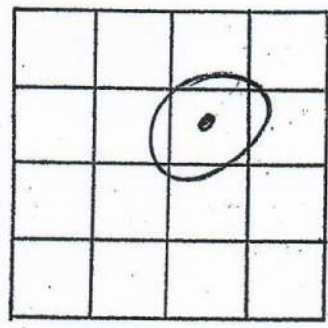

location not confirmed by owner well, I think is behind trailer at north gated airport

F. J. ...
Field Checked by

8-13-74
Date



November 3, 2015

Advice Letter No. 424

TO THE PUBLIC UTILITIES COMMISSION OF THE STATE OF CALIFORNIA

Del Oro Water Company, Inc. on behalf of its Walnut Ranch District (District) hereby transmits for filing the following Advice Letter No. 424 to recover costs associated with both the District's reimbursement of City of Colusa fees incurred in contract negotiations for the Emergency Transmission Intertie Project as well as District costs incurred with the Colusa Industrial Park Intertie Project. Changes in the respective District tariff schedule are attached hereto:

<u>Cal. P.U.C. Sheet No.</u>	<u>Title of Sheet</u>	<u>Schedule No.</u>	<u>Canceling Cal. P.U.C. Sheet No.</u>
-W	Schedule No. WR-2 (cont.) Residential Flat Rate Service	WR-2	1701-W
-W	Table of Contents		-W
-W			-W

Purpose

DOWC hereby submits this filing and the attached calculations [Exhibit A] in support of its claim for reimbursement of the costs associated with both the Emergency Transmission Intertie Project with the City of Colusa as well as those incurred with the Colusa Industrial Park Intertie Project. All costs have been tracked in DOWC's Preliminary Statement Paragraph S "Del Oro Water Company Extraordinary Events Emergency Water and/or Supplemental Water Memorandum Account (EEEW/SWMA)" [Exhibit B]. This account tracks costs which are incurred from time-to-time in purchasing water from outside agencies and/or interconnecting to outside agencies (either temporarily or permanently) in order to facilitate delivery of water for any of DOWC's districts. The EEEW/SWMA for the District has tracked all costs [Exhibit C] totaling \$93,845.29 specifically relating to contract negotiations with the City regarding the Emergency Transmission Intertie Project as well as the legal and engineering costs of the proposed Colusa Industrial Park Intertie Project.



Del Oro Water Co., Inc.
Advice Letter No. 424, WR (EEEW/SWMA)
Page Two

Background

CITY OF COLUSA/DOWC WALNUT RANCH EMERGENCY TRANSMISSION INTERTIE PROJECT

On August 18, 2008 Del Oro Water Company (DOWC), on behalf of its Walnut Ranch District, contacted Mr. Rob Hickey, then City Manager for the City of Colusa, and requested the City Council consider a permanent intertie to their system as an alternative to the Colusa Industrial Park Intertie Project which was suspended while the customers and the City explored the City purchasing the District's assets. DOWC thought an intertie with the City would provide its customers with potable water at the most reasonable cost. The City's ultimate position was that an intertie could only be used on an emergency basis and not considered a permanent solution to the water issues within the District.

As part of the agreement executed on February 3, 2009 with the City [Exhibit D], DOWC agreed to pay all City costs in bringing the emergency contract to fruition. A recent internal audit has found the costs totaling \$8,184.11 were not addressed for reimbursement to the District in discussions with the City. These costs are included in the total requested reimbursement.

THE COLUSA/DOWC INDUSTRIAL PARK INTERTIE PROJECT

→ In 2005, the District began working on an intertie project with the Colusa Industrial Park knowing the water issues within the District required an alternative source. Efforts were also required as a response to The State Water Resources Control Board's (formerly The State Department of Public Health) Compliance Order No. 01-21-10 on July 15, 2010 ordering the District to achieve compliance with the maximum contaminant level for Arsenic, which the District's water supply exceeded. Tremendous efforts and cooperation between the parties resulted in the Colusa Industrial Park Intertie Project [Exhibit E], approved by CPUC Res. W-4761, dated May 7, 2009 [Exhibit F], but which was stalled due to customers' desire to annex to the City of Colusa. In that regard, the District suspended work on the project and the project was classified in CPUC Res. W-4873 [Exhibit G] as "... currently suspended Industrial Park Intertie Project...". Point being made that the project was not disapproved but reimbursement was on hold pending the customers' and City's efforts to have the City of Colusa acquire the District.

Now comes forth the City of Colusa, as of October 29, 2015, with an officially tendered 'sole tentative offer' on fair market value as well as their recognition of the Purchase Water Surcharge (Advice Letter No. 366-A). However, we believe we have a disconnect regarding the recovery process for costs incurred in bringing the Colusa Industrial Park Intertie Project to a shovel ready status, and DOWC's entitlement to reimbursement for legal and associated appraisal costs to date.



Del Oro Water Co., Inc.
Advice Letter No. 424, WR (EEEW/SWMA)
Page Three

Therefore, The District proposes to collect the \$93,845.29 reflecting both the Emergency Transmission Intertie Project and the Colusa Industrial Park Intertie costs in a surcharge of \$20.58 per customer per month for sixty (60) months or until the full amount is collected.

Requested Effective Date

DOWC is submitting the attached as a Tier 3 filing and requests that it become effective at the earliest date as the Commission's decision is critical in negotiating with the City of Colusa.

Notice and Service

All customers and interested parties will be notified of the request for reimbursement of costs associated with the Colusa Industrial Park Intertie Project for Commission consideration and approval and its rate impact by way of direct mail on Tuesday, November 3, 2015 [Exhibit H].

File a PROTEST:

A protest is a document stating that you object to the utility receiving all or some part of its request. If you wish to file a protest, you must state the facts constituting the grounds for the protest, how the advice letter affects you, and the reasons why you believe the whole advice letter, or part of it, is not justified.

If the protest requests an evidentiary hearing (an evidentiary hearing is a legal proceeding held before an administrative law judge at the Commission to obtain evidence), your protest must state the facts you would present at the evidentiary hearing to support your request for a complete or a partial denial of the advice letter. The filing of a protest does not ensure that an evidentiary hearing will be held. The decision whether or not to hold an evidentiary hearing will be based on the contents of the protest.

File a RESPONSE:

A response is a document that does not object to the request sought in the application, but nevertheless, presents information you believe would be useful to the Commission in acting on the application.



Del Oro Water Co., Inc.
Advice Letter No. 424, WR (EEEW/SWMA)
Page Four

Whether you wish to file a PROTEST or send a RESPONSE you must:

- Send a copy of your document to the utility.
- A protest must be emailed or mailed (email preferred) within (20) days of the date you received this notice.

The utility must respond to your protest or response within five (5) days. All protests or responses to this filing should be sent to:

California Public Utilities Commission, *and*
Water Division
505 Van Ness Avenue
San Francisco, California 94102
E-Mail: water_division@cpuc.ca.gov

Director of Community Relations
Drawer 5172
Chico, CA 95927
(530) 717-2509 / Fax: (530) 894-7645
E-Mail: communityrelations@delorowater.com

If you have not received a reply to your protest within ten (10) business days, contact Del Oro Water Company at 1-530-717-2509.

This filing will not cause withdrawal of service nor conflict with any other schedule or rule.

A copy of Del Oro Water Company's filing may be inspected in its business office: 426 Broadway, Suite 301, Chico, California 95928 or by visiting the website at www.delorowater.com. Further information may be obtained from the utility at its business office or from the Commission at the above address.

Del Oro Water Company, Inc.

H *Janice Hanna*
JANICE HANNA
Director, Corporate Accounting

Attachments

This page intentionally left blank.

**Appendix 4-G
Outreach Materials**

This page intentionally left blank.



Sutter Subbasin <info@suttersubbasin.org>

You are Invited to Participate in the Sutter Subbasin Groundwater Sustainability Plan Development

Sutter Subbasin <info@suttersubbasin.org>

Fri, Oct 9, 2020 at 10:04 AM

To: Guadalupe Rivera <grivera@co.sutter.ca.us>, Leslie Dumas <ldumas@woodardcurran.com>, Nicole Poletto <NPoletto@woodardcurran.com>

Bcc: Natalie Cochran <ncochran@woodardcurran.com>, "jon@montnafarms.com" <jon@montnafarms.com>, "aduffey@succeed.net" <aduffey@succeed.net>, "jtdfwd@yahoo.com" <jtdfwd@yahoo.com>, "dd49erdd@yahoo.com" <dd49erdd@yahoo.com>, "Pschubert@gswater.com" <Pschubert@gswater.com>, "Grivera@co.sutter.ca.us" <Grivera@co.sutter.ca.us>, "morme@buttewater.net" <morme@buttewater.net>, "scrolls@rarcivil.com" <scrolls@rarcivil.com>, "lphillips@sutterewd.com" <lphillips@sutterewd.com>, "sutterwater@aol.com" <sutterwater@aol.com>, "kwillis@yubacity.net" <kwillis@yubacity.net>, "brad@sutterbasinwater.com" <brad@sutterbasinwater.com>, "carlyank48@gmail.com" <carlyank48@gmail.com>, "pelgerwater@comcast.net" <pelgerwater@comcast.net>, "Bridget.Gibbons@wildlife.ca.gov" <Bridget.Gibbons@wildlife.ca.gov>, "Lindsay@ysfarmbureau.com" <Lindsay@ysfarmbureau.com>, "Rachel@buttefarmbureau.com" <Rachel@buttefarmbureau.com>, "cjdobbas@yahoo.com" <cjdobbas@yahoo.com>, "ecenter@ecenter.org" <ecenter@ecenter.org>, "westbuttefarms@gmail.com" <westbuttefarms@gmail.com>, "wooleyfarms@msn.com" <wooleyfarms@msn.com>, "DhootFamilyFarms@gmail.com" <DhootFamilyFarms@gmail.com>, "randthomas@sbcglobal.net" <randthomas@sbcglobal.net>, "placersierraclub@gmail.com" <placersierraclub@gmail.com>, "lherbert@co.sutter.ca.us" <lherbert@co.sutter.ca.us>, "justine@ysfarmbureau.com" <justine@ysfarmbureau.com>, "melinda@yubariver.org" <melinda@yubariver.org>, "ashley@yubariver.org" <ashley@yubariver.org>, "creigm@enterpriserancheria.org" <creigm@enterpriserancheria.org>, "info@enterpriserancheria.org" <info@enterpriserancheria.org>, "barbarav@aqualliance.net" <barbarav@aqualliance.net>, "elias@bylt.org" <elias@bylt.org>, "erin@bylt.org" <erin@bylt.org>, "vgetz@ducks.org" <vgetz@ducks.org>, "eric@friendsoftheriver.org" <eric@friendsoftheriver.org>, "tobybriggs@friendsoftheriver.org" <tobybriggs@friendsoftheriver.org>, "kklausmeyer@tnc.org" <kklausmeyer@tnc.org>, "smatsumoto@tnc.org" <smatsumoto@tnc.org>, "melissa.rohde@tnc.org" <melissa.rohde@tnc.org>, "wetemplin@att.net" <wetemplin@att.net>, "claudia@ysfarmbureau.com" <claudia@ysfarmbureau.com>, "bill_mattos@yahoo.com" <bill_mattos@yahoo.com>, "bjennings@calsport.org" <bjennings@calsport.org>, "blancapaloma@msn.com" <blancapaloma@msn.com>, "lippelaw@sonic.net" <lippelaw@sonic.net>, "sarthur@audubon.org" <sarthur@audubon.org>, "jclary@cleanwater.org" <jclary@cleanwater.org>, "srothert@americanrivers.org" <srothert@americanrivers.org>, "lshunt@americanrivers.org" <lshunt@americanrivers.org>, "amassell@americanrivers.org" <amassell@americanrivers.org>, "jportiz@ucsusa.org" <jportiz@ucsusa.org>, "CWeintraub@ucsusa.org" <CWeintraub@ucsusa.org>, "espe@ejcw.org" <espe@ejcw.org>, "ktempleton@puentesca.org" <ktempleton@puentesca.org>, "info@communityresourceproject.org" <info@communityresourceproject.org>, "ssilva@newcurrentwater.com" <ssilva@newcurrentwater.com>, "rstork@friendsoftheriver.org" <rstork@friendsoftheriver.org>, "erin.strange@noaa.gov" <erin.strange@noaa.gov>, "jkatz@caltrout.org" <jkatz@caltrout.org>, "bzzroost@gmail.com" <bzzroost@gmail.com>, "jmerill@calclimateag.org" <jmerill@calclimateag.org>, "brian@calclimateag.org" <brian@calclimateag.org>, "info@caff.org" <info@caff.org>, "dave@caff.org" <dave@caff.org>, "info@communitywatercenter.org" <info@communitywatercenter.org>, "info@ejcw.org" <info@ejcw.org>, "cori@ejcw.org" <cori@ejcw.org>, "ddolan@lgc.org" <ddolan@lgc.org>, "efinnegan@lgc.org" <efinnegan@lgc.org>, "akeller@lgc.org" <akeller@lgc.org>, "erik@thefreshwatertrust.org" <erik@thefreshwatertrust.org>, "info@waterfdn.org" <info@waterfdn.org>



Good day,

The nine Groundwater Sustainability Agencies (GSAs) of Sutter Groundwater Subbasin are beginning to prepare a Groundwater Sustainability Plan (GSP) in response to the Sustainable Groundwater Management Act (SGMA). We are inviting local community members, non-profit organizations, farmers, landowners,

business owners, tribes, municipal agency staffers, and any other interested local stakeholders to participate in the process through public workshops, meetings, draft document review and direct input into the GSP development process. This is a great opportunity to get involved, learn about the planning process, and provide input on the future of groundwater management in the Sutter Subbasin.

Please let us know if you are interested in being included on the Interested Parties mailing list for the Sutter Subbasin GSP, respond back to npoletto@woodardcurran.com to be included. Updates on the GSP development process and notice of meetings and public workshops will be distributed via email (in addition to being posted on the GSP website). It is important that we hear your voice, as this GSP will be used to reliably meet current and future water demands in a cost-effective and sustainable manner within your area. Your participation is greatly appreciated.

Visit our website to learn more: www.SutterSubbasin.org. You can contact either me or Leslie Dumas of Woodard & Curran via email at the addresses included on this transmittal if you have any questions.

Thank You,

Guadalupe Rivera on behalf of Sutter Subbasin GSAs
Sutter County Development Services



Learn more at www.SutterSubbasin.org

Preparation of the 2022 Sutter Subbasin Groundwater Sustainability Plan is underway.

The nine Groundwater Sustainability Agencies of Sutter Groundwater Subbasin are beginning to prepare a Groundwater Sustainability Plan (GSP) in response to the Sustainable Groundwater Management Act (SGMA). In 2014, California enacted the SGMA to provide a framework for long-term sustainable groundwater management across California. The Sutter Subbasin is part of the Sacramento Valley Groundwater Basin and will submit a GSP to the State no later than January 31, 2022.

Sutter Subbasin GSP — Public Workshop #1

Monday, December 14, 2020 at 4:00 P.M. – 6:00 P.M.
Virtual meeting due to COVID-19

GET INVOLVED! *To sign up for our stakeholder list or learn more information visit our website.*

SutterSubbasin.org

Preparación del Plan de Sostenibilidad del Agua Subterránea (GSP) de la Subcuenca Sutter ha comenzado.

Las nueve agencias de Sostenibilidad del Agua Subterránea de la Subcuenca Sutter están comenzando a preparar un plan de GSP conforme a los requisitos de la Ley de Gestión Sostenible del Agua Subterránea (Sustainable Groundwater Management Act, SGMA). En 2014, California promulgó SGMA para proporcionar pautas para la gestión sostenible de las aguas subterráneas a largo plazo en todo California. La Subcuenca Sutter es parte de la Cuenca de Aguas Subterráneas del Valle de Sacramento y presentará un GSP al Estado a más tardar el 31 de enero de 2022.

Subcuenca Sutter GSP - Taller Público #1

Lunes, 14 de diciembre 2020 de 4:00 P.M. – 6:00 P.M.
Reunión virtual debido a COVID-19

¡INVOLÚCRATE! *Visite nuestro sitio web y regístrate para obtener más información.*

SutterSubbasin.org



Good afternoon,

The nine Groundwater Sustainability Agencies (GSAs) of Sutter Groundwater Subbasin are beginning to prepare a Groundwater Sustainability Plan (GSP) in response to the Sustainable Groundwater Management Act (SGMA). The GSP will be complete by the end of 2021.

We are inviting local community members, non-profit organizations, farmers, landowners, business owners, tribes, municipal agency staffers, and any other interested local stakeholders to participate in our first public workshop. This is a great opportunity to get involved, learn about the planning process, and provide input on the future of groundwater management in the Sutter Subbasin. The workshop will be held virtually due to COVID-19:

Sutter Subbasin GSP – Public Workshop #1

Monday, December 14, 2020 at 4:00 pm – 6:00 pm

GoToMeeting

Please join my meeting from your computer, tablet or smartphone:
<https://global.gotomeeting.com/join/537972085>.

You can also dial in using your phone: +1 (571) 317-3112, *Access Code: 537-972-085*

Discussion topics will include:

- Overview of SGMA
- Water management planning in the Sutter Subbasin
- Development of Sutter Subbasin Groundwater Sustainability Plan
- Basin Conditions

It is important that we hear your voice, as this GSP will be used to reliably meet current and future water demands in a cost-effective and sustainable manner within your area. Your participation is greatly appreciated.

Visit our website to learn more: www.SutterSubbasin.org. You can contact either me or Leslie Dumas of Woodard & Curran via email at the addresses included on this transmittal if you have any questions.

Thank You,

Guadalupe Rivera on behalf of Sutter Subbasin GSAs

Sutter County Development Services



Learn more at www.SutterSubbasin.org



Buenas tardes,

Las nueve agencias de Sostenibilidad del Agua Subterránea (Groundwater Sustainability Agencies, GSAs) de la Subcuenca Sutter están comenzando a preparar un plan de sostenibilidad del agua subterránea (GSP) conforme a los requisitos de la Ley de Gestión Sostenible del Agua Subterránea (Sustainable Groundwater Management Act, SGMA). El GSP será terminado hacia el final del año 2021.

Invitamos a miembros de la comunidad local, organizaciones sin fines de lucro, agricultores, terratenientes, dueños de negocios, tribus, personal de agencias municipales y cualquier otro interesado local interesado a participar en nuestro primer taller público. Esta es una gran oportunidad para involucrarse, aprender sobre el proceso de planificación y brindar información sobre el futuro de la gestión del agua subterránea en la Subcuenca Sutter. El taller se realizará virtualmente debido al COVID-19.

Subcuenca Sutter GSP – Taller Público #1

Lunes, 14 de diciembre 2020 de 4:00 pm – 6:00 pm

GoToMeeting

Únase a nuestra reunión desde su computadora, tableta o teléfono inteligente:
<https://global.gotomeeting.com/join/537972085>

También pueden marcar con su teléfono al: 1 (571) 317-3112, *código de acceso: 537-972-085*

Los temas de discusión incluirán:

- Descripción general de SGMA
- Planificación de la gestión del agua en la Subcuenca Sutter

- Desarrollo del Plan de Sostenibilidad del agua subterránea de la Subcuenca Sutter
- Condiciones de la cuenca

Es importante que escuchemos su voz, ya que este GSP se utilizará para satisfacer de manera confiable las demandas de agua actuales y futuras de una manera sostenible dentro de su área. Su participación es sumamente apreciada.

Visite nuestro sitio web para obtener más información: www.SutterSubbasin.org. Puede ponerse en contacto conmigo o con Guadalupe Rivera de Conando de Sutter por correo electrónico a las direcciones incluidas en esta notificación si tiene alguna pregunta.

Gracias,

Guadalupe Rivera, en nombre de los GSAs de la Subcuenca Sutter
Servicios de Desarrollo del Condado de Sutter



Aprende más en www.SutterSubbasin.org



ਨਮਸਕਾਰ,

ਸਟਰ ਗਰਾਊਂਡ ਵਾਟਰ ਸਬਬੇਸਿਨ ਦੀਆਂ ਨੌਂ ਏਜੰਸੀਆਂ ਧਰਤੀ ਹੇਠਲੇ ਪਾਣੀ ਦੀ ਸਥਿਰਤਾ ਲਈ ਸਥਾਈ ਧਰਤੀ ਹੇਠਲਾ ਪ੍ਰਬੰਧਨ ਐਕਟ (ਐਸਜੀਐਮਏ) ਦੇ ਜਵਾਬ ਵਿੱਚ ਧਰਤੀ ਹੇਠਲੇ ਪਾਣੀ ਦੀ ਸਥਿਰਤਾ ਯੋਜਨਾ (ਜੀਐਸਪੀ) ਤਿਆਰ ਕਰਨ ਲੱਗੀਆਂ ਹਨ। ਜੀਐਸਪੀ 2021 ਦੇ ਅੰਤ ਤੱਕ ਪੂਰਾ ਹੋ ਜਾਵੇਗਾ।

ਅਸੀਂ ਸਥਾਨਕ ਕਮਿਨਿਟੀ ਮੈਂਬਰਾਂ, ਗੈਰ-ਮੁਨਾਫਾ ਸੰਗਠਨਾਂ, ਕਿਸਾਨਾਂ, ਜ਼ਿਮੀਂਦਾਰਾਂ, ਕਾਰੋਬਾਰੀ ਮਾਲਕਾਂ, ਗੋਤਾਂ, ਨਗਰ ਨਿਗਮ ਏਜੰਸੀ ਦੇ ਕਰਮਚਾਰੀਆਂ ਅਤੇ ਕਿਸੇ ਵੀ ਹੋਰ ਦਿਲਚਸਪੀ ਵਾਲੇ ਸਥਾਨਕ ਹਿੱਸੇਦਾਰਾਂ ਨੂੰ ਸਾਡੀ ਪਹਿਲੀ ਜਨਤਕ ਵਰਕਸ਼ਾਪ ਵਿੱਚ ਹਿੱਸਾ ਲੈਣ ਲਈ ਸੱਦਾ ਦੇ ਰਹੇ ਹਾਂ। ਸ਼ਾਮਲ ਹੋਣ, ਯੋਜਨਾਬੰਦੀ ਪ੍ਰਕਿਰਿਆ ਬਾਰੇ ਜਾਣਨ ਅਤੇ ਸਟਰ ਸਬਬੇਸਿਨ ਵਿੱਚ ਧਰਤੀ ਹੇਠਲੇ ਪਾਣੀ ਦੇ ਪ੍ਰਬੰਧਨ ਦੇ ਭਵਿੱਖ ਬਾਰੇ ਜਾਣਕਾਰੀ ਪ੍ਰਦਾਨ ਕਰਨ ਦਾ ਇਹ ਇੱਕ ਵਧੀਆ ਮੌਕਾ ਹੈ। ਵਰਕਸ਼ਾਪ COVID-19 ਦੇ ਕਾਰਨ ਵਰਚੁਅਲੀ ਆਯੋਜਿਤ ਕੀਤੀ ਜਾਏਗੀ।

ਸਟਰ ਸਬਬੇਸਿਨ ਜੀਐਸਪੀ - ਪਬਲਿਕ ਵਰਕਸ਼ਾਪ # 1

ਸੋਮਵਾਰ, 14 ਦਸੰਬਰ, 2020 ਸ਼ਾਮ 4:00 ਵਜੇ - ਸ਼ਾਮ 6 ਵਜੇ

ਮੁਲਾਕਾਤ ਕਰਨ ਲਈ ਜਾਓ

ਕਿਰਪਾ ਕਰਕੇ ਆਪਣੇ ਕੰਪਿਓਟਰ, ਟੈਬਲੇਟ ਜਾਂ ਸਮਾਰਟਫੋਨ ਤੋਂ ਮੇਰੀ ਮੀਟਿੰਗ ਵਿੱਚ ਸ਼ਾਮਲ ਹੋਵੋ:

<https://global.gotomeeting.com/join/537972085>.

ਤੁਸੀਂ ਆਪਣੇ ਫੋਨ ਦੀ ਵਰਤੋਂ ਕਰਕੇ ਵੀ ਡਾਇਲ ਕਰ ਸਕਦੇ ਹੋ: +1 (571) 317-3112, ਐਕਸੈਸ ਕੋਡ: 537-972-085

ਵਿਚਾਰ ਵਿਸ਼ਾਵਾਂ ਵਿੱਚ ਸ਼ਾਮਲ ਹੋਣਗੇ:

- ਐਸਜੀਐਮਏ ਬਾਰੇ ਸੰਖੇਪ ਜਾਣਕਾਰੀ
- ਸਟਰ ਸਬਬੇਸਿਨ ਵਿਚ ਪਾਣੀ ਪ੍ਰਬੰਧਨ ਦੀ ਯੋਜਨਾਬੰਦੀ
- ਸਟਰ ਸਬਬੇਸਿਨ ਧਰਤੀ ਹੇਠਲੇ ਪਾਣੀ ਦੀ ਸਥਿਰਤਾ ਯੋਜਨਾ ਦਾ ਵਿਕਾਸ
- ਬੇਸਿਨ ਦੇ ਹਾਲਾਤ

ਇਹ ਮਹੱਤਵਪੂਰਨ ਹੈ ਕਿ ਅਸੀਂ ਤੁਹਾਡੀ ਆਵਾਜ਼ ਸੁਣੀਏ, ਕਿਉਂਕਿ ਇਹ ਜੀਐਸਪੀ ਤੁਹਾਡੇ ਖੇਤਰ ਦੇ ਅੰਦਰ ਲਾਗਤ-ਪ੍ਰਭਾਵਸ਼ਾਲੀ ਅਤੇ ਭਰੋਸੇ ਨਾਲ ਮੌਜੂਦਾ ਅਤੇ ਭਵਿੱਖ ਦੀਆਂ ਪਾਣੀ ਦੀਆਂ ਮੰਗਾਂ ਨੂੰ ਭਰੋਸੇਯੋਗ ਤਰੀਕੇ ਨਾਲ ਪੂਰਾ ਕਰਨ ਲਈ ਵਰਤੀ ਜਾਏਗੀ। ਤੁਹਾਡੀ ਭਾਗੀਦਾਰੀ ਦੀ ਬਹੁਤ ਪ੍ਰਸ਼ੰਸਾ ਕੀਤੀ ਗਈ।

ਵਧੇਰੇ ਜਾਣਨ ਲਈ ਸਾਡੀ ਵੈਬਸਾਈਟ ਤੇ ਜਾਓ: www.SutterSubbasin.org ਜੇ ਤੁਹਾਡੇ ਕੋਈ ਪ੍ਰਸ਼ਨ ਹਨ, ਤਾਂ ਤੁਸੀਂ ਇਸ ਸੰਚਾਰ 'ਤੇ ਸ਼ਾਮਲ ਪਤੇ' ਤੇ ਜਾਂ ਤਾਂ ਮੇਰੇ ਜਾਂ ਵੁਡਾਰਡ ਐਂਡ ਕੁਰਾਨ ਦੇ ਲੈਸਲੀ ਡੋਮਸ ਨਾਲ ਈਮੇਲ ਰਾਹੀਂ ਸੰਪਰਕ ਕਰ ਸਕਦੇ ਹੋ।

ਤੁਹਾਡਾ ਧੰਨਵਾਦ,

ਗੁੱਡਾਲੂਪ ਰਿਵੇਰਾ ਸਟਰ ਸਬਬੇਸਿਨ ਜੀਐਸਏ ਦੀ ਤਰਫੋਂ
ਸਟਰ ਕਾਉਂਟੀ ਡਿਵੈਲਪਮੈਂਟ ਸਰਵਿਸਿਜ਼



ਵਧੇਰੇ ਜਾਣੋ www.SutterSubbasin.org



Public Workshop #1

Monday, December 14, 2020

Learn more at SutterSubbasin.org

The nine Groundwater Sustainability Agencies (GSAs) of Sutter Groundwater Subbasin are beginning to prepare a Groundwater Sustainability Plan (GSP) in response to the Sustainable Groundwater Management Act (SGMA). Participants are encouraged to attend and provide feedback for the Sutter Subbasin GSP.

Sutter Subbasin GSP — Public Workshop #1

Monday, December 14, 2020 at 4:00 P.M. – 6:00 P.M.

GoToMeeting (remote/virtual)

Please join from your computer, tablet or smartphone:

 <https://global.gotomeeting.com/join/537972085>

Or dial-in:

 (571) 317-3112, Code: 537-972-085

Traducción al Español disponible. Contacto Guadalupe Rivera si tiene alguna pregunta.
info@suttersubbasin.org

Discussion topics will include:

- Overview of SGMA
- Water management planning in the Sutter Subbasin
- Development of Sutter Subbasin Groundwater Sustainability Plan
- Basin Conditions



It is important that we hear your voice, as this GSP will be used to reliably meet current and future water demands in a cost-effective and sustainable manner within your area. *Your participation is greatly appreciated!*

Preparation of the 2022 Sutter Subbasin Groundwater Sustainability Plan is underway.

The nine Groundwater Sustainability Agencies of Sutter Groundwater Subbasin are beginning to prepare a Groundwater Sustainability Plan (GSP) in response to the Sustainable Groundwater Management Act (SGMA). In 2014, California enacted the SGMA to provide a framework for long-term sustainable groundwater management across California. The Sutter Subbasin is part of the Sacramento Valley Groundwater Basin and will submit a GSP to the State no later than January 31, 2022.

Sutter Subbasin GSP - Public Workshop 2/8/21

All meetings will be held virtually due to COVID-19 until further notice. Visit our website for more information.

GET INVOLVED! To sign up for our stakeholder list or learn more information visit our website.

SutterSubbasin.org

Aviso

Preparación del Plan de Sostenibilidad del Agua Subterránea (GSP) de la Subcuenca Sutter ha comenzado.

Las nueve agencias de Sostenibilidad del Agua Subterránea de la Subcuenca Sutter están comenzando a preparar un plan de GSP conforme a los requisitos de la Ley de Gestión Sostenible del Agua Subterránea (Sustainable Groundwater Management Act, SGMA). En 2014, California promulgó SGMA para proporcionar pautas para la gestión sostenible de las aguas subterráneas a largo plazo en todo California. La Subcuenca Sutter es parte de la Cuenca de Aguas Subterráneas del Valle de Sacramento y presentará un GSP al Estado a más tardar el 31 de enero de 2022.

Subcuenca Sutter GSP - Taller Público 2/8/21

Debido a COVID-19, todas las reuniones se llevarán a cabo virtualmente hasta nuevo aviso.

¡INVOLÚCRATE! Visite nuestro sitio web y regístrate para obtener más información.

SutterSubbasin.org

ਨੋਟਿਸ

2022 ਦੀ ਸਟਰ ਸਬਬੇਸਨਿ ਧਰਤੀ ਹੇਠਲੇ ਪਾਣੀ ਦੀ ਸਥਰਿਤਾ ਯੋਜਨਾ ਦੀ ਤਿਆਰੀ ਚੱਲ ਰਹੀ ਹੈ।

ਸਟਰ ਗਰਾਊਂਡ ਵਾਟਰ ਸਬਬੇਸਨਿ ਦੀਆਂ ਨੌਂ ਏਜੰਸੀਆਂ ਧਰਤੀ ਹੇਠਲੇ ਪਾਣੀ ਦੀ ਸਥਰਿਤਾ ਲਈ 'ਸਥਾਈ ਧਰਤੀ ਹੇਠਲਾ ਪ੍ਰਬੰਧਨ ਐਕਟ' (ਐਸਜੀਐਮਏ) ਦੇ ਜਵਾਬ ਵੱਜੋਂ ਧਰਤੀ ਹੇਠਲੇ ਪਾਣੀ ਦੀ ਸਥਰਿਤਾ ਯੋਜਨਾ (ਜੀਐਸਪੀ) ਤਿਆਰ ਕਰਨ ਲੱਗੀਆਂ ਹਨ। 2014 ਵੱਜੋਂ ਕੈਲੀਫੋਰਨੀਆ ਨੇ ਕੈਲੀਫੋਰਨੀਆ ਵੱਜੋਂ ਲੰਬੇ ਸਮੇਂ ਲਈ ਟੁਕਿਣ ਵਾਲੇ ਧਰਤੀ ਹੇਠਲੇ ਪਾਣੀ ਪ੍ਰਬੰਧਨ ਲਈ ਇੱਕ ਢਾਂਚਾ ਪ੍ਰਦਾਨ ਕਰਨ ਲਈ ਐਸਜੀਐਮਏ ਨੂੰ ਲਾਗੂ ਕੀਤਾ। ਸਟਰ ਸਬਬੇਸਨਿ ਸੈਕਰਾਮੈਂਟੋ ਵੈਲੀ ਗਰਾਊਂਡ ਵਾਟਰ ਬੇਸਨਿ ਦਾ ਹੱਸਿਾ ਹੈ ਅਤੇ 31 ਜਨਵਰੀ, 2022 ਤੱਕ ਕੈਲੀਫੋਰਨੀਆ ਸਟੇਟ ਨੂੰ ਜੀਐਸਪੀ ਤਿਆਰ ਕਰਕੇ ਦੇਵੇਗਾ।

ਸਟਰ ਸਬਬੇਸਨਿ ਜੀਐਸਪੀ - ਪਬਲਿਕ ਵਰਕਸ਼ਾਪ 2/8/21

ਅਗਲੀਆਂ ਸੂਚਨਾਵਾਂ ਤਕ ਸਾਰੀਆਂ ਮੀਟਿੰਗਾਂ ਵਰਚੁਅਲ ਹੋਣਗੀਆਂ। ਵਧੇਰੇ ਜਾਣਕਾਰੀ ਲਈ ਸਾਡੀ ਵੈਬਸਾਈਟ ਵੇਖੋ

ਸ਼ਾਮਲ ਹੋਵੋ! ਸਾਡੇ ਹੱਸਿਦਾਰਾਂ ਦੀ ਸੂਚੀ ਲਈ ਸਾਈਨ-ਅਪ ਕਰਨ ਜਾਂ ਵਧੇਰੇ ਜਾਣਕਾਰੀ ਲਈ ਸਾਡੀ ਵੈਬਸਾਈਟ ਤੇ ਜਾਓ

SutterSubbasin.org



Good afternoon,

The nine Groundwater Sustainability Agencies (GSAs) of Sutter Groundwater Subbasin are preparing a Groundwater Sustainability Plan (GSP) in response to the Sustainable Groundwater Management Act (SGMA). The GSP will be complete by the end of 2021.

We are inviting local community members, non-profit organizations, farmers, landowners, business owners, tribal communities, municipal agency staffers, and any other interested local stakeholders to participate in our second public workshop. Meeting materials from our first public workshop can be found on our website at www.suttersubbasin.org. This is a great opportunity to get involved, learn about the planning process, and provide input on the future of groundwater management in the Sutter Subbasin. The workshop will be held virtually due to COVID-19:

Sutter Subbasin GSP – Public Workshop #2

Monday, February 8, 2021 at 4:00 pm – 6:00 pm

GoToMeeting

Please join my meeting from your computer, tablet or smartphone:
<https://global.gotomeeting.com/join/567184029>.

You can also dial in using your phone: +1 (571) 317-3112, *Access Code*: 567-184-029

Discussion topics will include:

- Review of Basin Conditions
- Hydrogeologic Conceptual Model
- Introduction to Groundwater Flow Modeling
- Significant and Unreasonable Undesirable Results
- Preliminary List of Projects and Management Actions

We are interested in hearing more from you! Please participate in our stakeholder survey found on the homepage of our website. It is important that we hear your voice, as this GSP will be used to reliably meet current and future water demands in a cost-effective and sustainable manner within your area. Your participation in our survey and public workshops is greatly appreciated.

Visit our website to learn more: www.SutterSubbasin.org. You can contact either me or Leslie Dumas of Woodard & Curran via email at the addresses included on this transmittal if you have any questions.

Thank You,

Guadalupe Rivera on behalf of Sutter Subbasin GSAs
Sutter County Development Services



Learn more at www.SutterSubbasin.org



Buenas tardes,

Las nueve agencias de Sostenibilidad del Agua Subterránea (Groundwater Sustainability Agencies, GSAs) de la Subcuenca Sutter comenzaron a preparar un plan de sostenibilidad del agua subterránea (GSP) conforme a los requisitos de la Ley de Gestión Sostenible del Agua Subterránea (Sustainable Groundwater Management Act, SGMA). El GSP será terminado hacia el final del año 2021.

Invitamos a miembros de la comunidad local, organizaciones sin fines de lucro, agricultores, terratenientes, dueños de negocios, comunidades tribales, personal de agencias municipales y cualquier otro interesado local interesado a participar en nuestro segundo taller público. Los materiales de la reunión de nuestro primer taller público se pueden encontrar en nuestro sitio web en www.suttersubbasin.org. Esta es una gran oportunidad para involucrarse, aprender sobre el proceso de planificación y brindar información sobre el futuro de la gestión del agua subterránea en la Subcuenca Sutter. El taller se realizará virtualmente debido al COVID-19.

Subcuenca Sutter GSP – Taller Público #2

Lunes, 8 de febrero 2021 de 4:00 pm – 6:00 pm

GoToMeeting

Únase a nuestra reunión desde su computadora, tableta o teléfono inteligente:
<https://global.gotomeeting.com/join/567184029>.

También pueden marcar con su teléfono al: 1 (571) 317-3112, *código de acceso*: 567-184-029

Los temas de discusión incluirán:

- Revisión de las condiciones de la cuenca
- Modelo conceptual hidrogeológico
- Introducción al modelado de flujo de agua subterránea
- Resultados no deseados importantes e irrazonables
- Lista preliminar de proyectos y acciones de gestión

¡Estamos interesados en saber más de usted! Participe en nuestra encuesta que se encuentra en la página de inicio de nuestro sitio web. Es importante que escuchemos su voz, ya que este GSP se utilizará para satisfacer de manera confiable las demandas de agua actuales y futuras de una manera sostenible dentro de su área. Su participación en nuestra encuesta y talleres públicos es sumamente apreciada.

Visite nuestro sitio web para obtener más información: www.SutterSubbasin.org. Puede ponerse en contacto conmigo o con Guadalupe Rivera de Conando de Sutter por correo electrónico a las direcciones incluidas en esta notificación si tiene alguna pregunta.

Gracias,

Guadalupe Rivera, en nombre de los GSAs de la Subcuenca Sutter
Servicios de Desarrollo del Condado de Sutter



Aprende más en www.SutterSubbasin.org



ਨਮਸਕਾਰ,

ਸਟਰ ਗਰਾਊਂਡ ਵਾਟਰ ਸਬਬੇਸਿਨ ਦੀਆਂ ਨੌਂ ਏਜੰਸੀਆਂ ਧਰਤੀ ਹੇਠਲੇ ਪਾਣੀ ਦੀ ਸਥਿਰਤਾ ਲਈ ਸਥਾਈ ਧਰਤੀ ਹੇਠਲਾ ਪ੍ਰਬੰਧਨ ਐਕਟ (ਐਸਜੀਐਮਏ) ਦੇ ਜਵਾਬ ਵਿੱਚ ਧਰਤੀ ਹੇਠਲੇ ਪਾਣੀ ਦੀ ਸਥਿਰਤਾ ਯੋਜਨਾ (ਜੀਐਸਪੀ) ਤਿਆਰ ਕਰਨ ਲੱਗੀਆਂ ਹਨ। ਜੀਐਸਪੀ 2021 ਦੇ ਅੰਤ ਤੱਕ ਪੂਰਾ ਹੋ ਜਾਵੇਗਾ। ਅਸੀਂ ਸਥਾਨਕ ਕਮਿਨਿਟੀ ਮੈਂਬਰਾਂ, ਗੈਰ-ਮੁਨਾਫਾ ਸੰਗਠਨਾਂ, ਕਿਸਾਨਾਂ, ਜ਼ਿਮੀਂਦਾਰਾਂ, ਕਾਰੋਬਾਰੀ ਮਾਲਕਾਂ, ਗੋਤਾਂ, ਨਗਰ ਨਿਗਮ ਏਜੰਸੀ ਦੇ ਕਰਮਚਾਰੀਆਂ ਅਤੇ ਕਿਸੇ ਵੀ ਹੋਰ ਦਿਲਚਸਪੀ ਵਾਲੇ ਸਥਾਨਕ ਹਿੱਸੇਦਾਰਾਂ ਨੂੰ ਸਾਡੀ ਦੂਜੀ ਜਨਤਕ ਵਰਕਸ਼ਾਪ ਵਿੱਚ ਹਿੱਸਾ ਲੈਣ ਲਈ ਸੱਦਾ ਦੇ ਰਹੇ ਹਾਂ। ਸ਼ਾਮਲ ਹੋਣ, ਯੋਜਨਾਬੰਦੀ ਪ੍ਰਕਿਰਿਆ ਬਾਰੇ ਜਾਣਨ ਅਤੇ

ਸਟਰ ਸਬਬੇਸਿਨ ਵਿਚ ਧਰਤੀ ਹੇਠਲੇ ਪਾਣੀ ਦੇ ਪ੍ਰਬੰਧਨ ਦੇ ਭਵਿੱਖ ਬਾਰੇ ਜਾਣਕਾਰੀ ਪ੍ਰਦਾਨ ਕਰਨ ਦਾ ਇਹ ਇਕ ਵਧੀਆ ਮੌਕਾ ਹੈ । ਵਰਕਸ਼ਾਪ COVID-19 ਦੇ ਕਾਰਨ ਵਰਚੁਅਲੀ ਆਯੋਜਿਤ ਕੀਤੀ ਜਾਏਗੀ ।

ਸਟਰ ਸਬਬੇਸਿਨ ਜੀਐਸਪੀ - ਪਬਲਿਕ ਵਰਕਸ਼ਾਪ # 2

ਸੋਮਵਾਰ, 14 ਦਸੰਬਰ, 2021 ਸ਼ਾਮ 4:00 ਵਜੇ - ਸ਼ਾਮ 6 ਵਜੇ

ਮੁਲਾਕਾਤ ਕਰਨ ਲਈ ਜਾਓ

ਕਿਰਪਾ ਕਰਕੇ ਆਪਣੇ ਕੰਪਿਓਟਰ, ਟੈਬਲੇਟ ਜਾਂ ਸਮਾਰਟਫੋਨ ਤੋਂ ਮੇਰੀ ਮੀਟਿੰਗ ਵਿੱਚ ਸ਼ਾਮਲ ਹੋਵੋ:

<https://global.gotomeeting.com/join/567184029>

ਤੁਸੀਂ ਆਪਣੇ ਫੋਨ ਦੀ ਵਰਤੋਂ ਕਰਕੇ ਵੀ ਡਾਇਲ ਕਰ ਸਕਦੇ ਹੋ: +1 (571) 317-3112, ਐਕਸੈਸ ਕੋਡ: 567-184-029.

ਵਿਚਾਰ ਵਿਸ਼ਾਵਾਂ ਵਿੱਚ ਸ਼ਾਮਲ ਹੋਣਗੇ:

- ਬੇਸਿਨ ਦੇ ਹਾਲਾਤ
- ਹਾਈਡਰੋਜੇਲੋਜੀਕਲ ਸੰਕਲਪ ਮਾਡਲ
- ਧਰਤੀ ਹੇਠਲੇ ਪਾਣੀ ਦੇ ਪ੍ਰਵਾਹ ਮਾਡਲਿੰਗ
- ਅਣਚਾਹੇ ਨਤੀਜੇ
- ਪ੍ਰੋਜੈਕਟਾਂ ਦੀ ਸੂਚੀ

ਸਾਡੀ ਵਰਕਸ਼ਾਪਾਂ ਤੋਂ ਮਿਲਣ ਵਾਲੀ ਸਮੱਗਰੀ ਸਾਡੀ ਵੈਬਸਾਈਟ www.suttersubbasin.org 'ਤੇ ਪਾਈ ਜਾ ਸਕਦੀ ਹੈ. ਇਹ ਮਹੱਤਵਪੂਰਨ ਹੈ ਕਿ ਅਸੀਂ ਤੁਹਾਡੀ ਆਵਾਜ਼ ਸੁਣੀਏ, ਕਿਉਂਕਿ ਇਹ ਜੀਐਸਪੀ ਤੁਹਾਡੇ ਖੇਤਰ ਦੇ ਅੰਦਰ ਲਾਗਤ-ਪ੍ਰਭਾਵਸ਼ਾਲੀ ਅਤੇ ਭਰੋਸੇ ਨਾਲ ਮੌਜੂਦਾ ਅਤੇ ਭਵਿੱਖ ਦੀਆਂ ਪਾਣੀ ਦੀਆਂ ਮੰਗਾਂ ਨੂੰ ਭਰੋਸੇਯੋਗ ਤਰੀਕੇ ਨਾਲ ਪੂਰਾ ਕਰਨ ਲਈ ਵਰਤੀ ਜਾਏਗੀ. ਤੁਹਾਡੀ ਭਾਗੀਦਾਰੀ ਦੀ ਬਹੁਤ ਪ੍ਰਸ਼ੰਸਾ ਕੀਤੀ ਗਈ ।

ਵਧੇਰੇ ਜਾਣਨ ਲਈ ਸਾਡੀ ਵੈਬਸਾਈਟ ਤੇ ਜਾਓ: www.SutterSubbasin.org ਜੇ ਤੁਹਾਡੇ ਕੋਈ ਪ੍ਰਸ਼ਨ ਹਨ, ਤਾਂ ਤੁਸੀਂ ਇਸ ਸੰਚਾਰ 'ਤੇ ਸ਼ਾਮਲ ਪਤੇ' ਤੇ ਜਾਂ ਤਾਂ ਮੇਰੇ ਜਾਂ ਵੁਡਾਰਡ ਐਂਡ ਕੁਰਾਨ ਦੇ ਲੈਸਲੀ ਡੋਮਸ ਨਾਲ ਈਮੇਲ ਰਾਹੀਂ ਸੰਪਰਕ ਕਰ ਸਕਦੇ ਹੋ ।

ਤੁਹਾਡਾ ਧੰਨਵਾਦ,

ਗੁੱਡਾਲੂਪ ਰਿਵੇਰਾ ਸਟਰ ਸਬਬੇਸਿਨ ਜੀਐਸਪੀ ਦੀ ਤਰਫੋਂ
ਸਟਰ ਕਾਉਂਟੀ ਡਿਵੈਲਪਮੈਂਟ ਸਰਵਿਸਿਜ਼



ਵਧੇਰੇ ਜਾਣੋ www.SutterSubbasin.org



Public Workshop #2

Monday, February 8, 2021

Learn more at SutterSubbasin.org

The nine Groundwater Sustainability Agencies (GSAs) of Sutter Groundwater Subbasin are preparing a Groundwater Sustainability Plan (GSP) in response to the Sustainable Groundwater Management Act (SGMA). Participants are encouraged to attend and provide feedback for the Sutter Subbasin GSP.

Sutter Subbasin GSP — Public Workshop #2

Monday, February 8, 2021 at 4:00 P.M. – 6:00 P.M.

GoToMeeting (remote/virtual)

Please join from your computer, tablet or smartphone:

 <https://global.gotomeeting.com/join/567184029>

Or dial-in:

 1 (571) 317-3112, Code: 567-184-029

Para obtener ayuda con traducción al español, comuníquese con Guadalupe Rivera a través de correo electrónico al info@suttersubbasin.org por lo menos 72 horas antes de la reunión.

ਅਨੁਵਾਦ ਸਹਾਇਤਾ ਲਈ, ਕਰਿਪਾ ਕਰਕੇ ਮੀਟਿੰਗ ਤੋਂ ਘੱਟੋ ਘੱਟ 72 ਘੰਟੇ ਪਹਿਲਾਂ info@suttersubbasin.org ਤੇ ਲੈਸਲੀ ਡੂਮਾਸ ਨਾਲ ਸੰਪਰਕ ਕਰੋ

Discussion topics will include:

- Review of Basin Conditions
- Hydrogeologic Conceptual Model
- Introduction to Groundwater Flow Modeling
- Significant and Unreasonable Undesirable Results
- Preliminary List of Projects and Management Actions



It is important that we hear your voice, as this GSP will be used to reliably meet current and future water demands in a cost-effective and sustainable manner within your area.

Your participation is greatly appreciated!

Preparation of the 2022 Sutter Subbasin Groundwater Sustainability Plan is underway.

The nine Groundwater Sustainability Agencies of Sutter Groundwater Subbasin are beginning to prepare a Groundwater Sustainability Plan (GSP) in response to the Sustainable Groundwater Management Act (SGMA). In 2014, California enacted the SGMA to provide a framework for long-term sustainable groundwater management across California. The Sutter Subbasin is part of the Sacramento Valley Groundwater Basin and will submit a GSP to the State no later than January 31, 2022.

Sutter Subbasin GSP - Public Workshop 6/15/21

All meetings will be held virtually due to COVID-19 until further notice. Visit our website for more information.

GET INVOLVED! To sign up for our stakeholder list or learn more information visit our website.

SutterSubbasin.org

Aviso

Preparación del Plan de Sostenibilidad del Agua Subterránea (GSP) de la Subcuenca Sutter ha comenzado.

Las nueve agencias de Sostenibilidad del Agua Subterránea de la Subcuenca Sutter están comenzando a preparar un plan de GSP conforme a los requisitos de la Ley de Gestión Sostenible del Agua Subterránea (Sustainable Groundwater Management Act, SGMA). En 2014, California promulgó SGMA para proporcionar pautas para la gestión sostenible de las aguas subterráneas a largo plazo en todo California. La Subcuenca Sutter es parte de la Cuenca de Aguas Subterráneas del Valle de Sacramento y presentará un GSP al Estado a más tardar el 31 de enero de 2022.

Subcuenca Sutter GSP - Taller Público 6/15/21

Debido a COVID-19, todas las reuniones se llevarán a cabo virtualmente hasta nuevo aviso.

¡INVOLÚCRATE! Visite nuestro sitio web y regístrate para obtener más información.

SutterSubbasin.org

ਨੋਟਿਸ

2022 ਦੀ ਸਟਰ ਸਬਬੇਸਨਿ ਧਰਤੀ ਹੇਠਲੇ ਪਾਣੀ ਦੀ ਸਥਿਰਤਾ ਯੋਜਨਾ ਦੀ ਤਿਆਰੀ ਚੱਲ ਰਹੀ ਹੈ।

ਸਟਰ ਗਰਾਊਂਡ ਵਾਟਰ ਸਬਬੇਸਨਿ ਦੀਆਂ ਨੌਂ ਏਜੰਸੀਆਂ ਧਰਤੀ ਹੇਠਲੇ ਪਾਣੀ ਦੀ ਸਥਿਰਤਾ ਲਈ 'ਸਥਾਈ ਧਰਤੀ ਹੇਠਲਾ ਪ੍ਰਬੰਧਨ ਐਕਟ' (ਐਸਜੀਐਮਏ) ਦੇ ਜਵਾਬ ਵੱਜੋਂ ਧਰਤੀ ਹੇਠਲੇ ਪਾਣੀ ਦੀ ਸਥਿਰਤਾ ਯੋਜਨਾ (ਜੀਐਸਪੀ) ਤਿਆਰ ਕਰਨ ਲੱਗੀਆਂ ਹਨ। 2014 ਵੱਜੋਂ ਕੈਲੀਫੋਰਨੀਆ ਨੇ ਕੈਲੀਫੋਰਨੀਆ ਵੱਜੋਂ ਲੰਬੇ ਸਮੇਂ ਲਈ ਟੁਕੜ ਵਾਲੇ ਧਰਤੀ ਹੇਠਲੇ ਪਾਣੀ ਪ੍ਰਬੰਧਨ ਲਈ ਇੱਕ ਢਾਂਚਾ ਪ੍ਰਦਾਨ ਕਰਨ ਲਈ ਐਸਜੀਐਮਏ ਨੂੰ ਲਾਗੂ ਕੀਤਾ। ਸਟਰ ਸਬਬੇਸਨਿ ਸੈਕਰਾਮੈਂਟੋ ਵੈਲੀ ਗਰਾਊਂਡ ਵਾਟਰ ਬੇਸਨਿ ਦਾ ਹੱਸਿਾ ਹੈ ਅਤੇ 31 ਜਨਵਰੀ, 2022 ਤੱਕ ਕੈਲੀਫੋਰਨੀਆ ਸਟੇਟ ਨੂੰ ਜੀਐਸਪੀ ਤਿਆਰ ਕਰਕੇ ਦੇਵੇਗਾ।

ਸਟਰ ਸਬਬੇਸਨਿ ਜੀਐਸਪੀ - ਪਬਲਿਕ ਵਰਕਸ਼ਾਪ 6/15/21

ਅਗਲੀਆਂ ਸੂਚਨਾਵਾਂ ਤਕ ਸਾਰੀਆਂ ਮੀਟਿੰਗਾਂ ਵਰਚੁਅਲ ਹੋਣਗੀਆਂ। ਵਧੇਰੇ ਜਾਣਕਾਰੀ ਲਈ ਸਾਡੀ ਵੈੱਬਸਾਈਟ ਵੇਖੋ

ਸ਼ਾਮਲ ਹੋਵੋ! ਸਾਡੇ ਹੱਸਿਦਾਰਾਂ ਦੀ ਸੂਚੀ ਲਈ ਸਾਈਨ-ਅਪ ਕਰਨ ਜਾਂ ਵਧੇਰੇ ਜਾਣਕਾਰੀ ਲਈ ਸਾਡੀ ਵੈੱਬਸਾਈਟ ਤੇ ਜਾਓ

SutterSubbasin.org



Good afternoon,

The nine Groundwater Sustainability Agencies (GSAs) of Sutter Groundwater Subbasin are preparing a Groundwater Sustainability Plan (GSP) in response to the Sustainable Groundwater Management Act (SGMA). The GSP will be complete by the end of 2021.

Our third public workshop for the 2022 *Sutter Subbasin Groundwater Sustainability Plan* is next **Tuesday, June 15, 2021 from 6pm to 8pm**. We encourage all local community members, non-profit organizations, farmers, landowners, business owners, tribal communities, municipal agency staffers, and any other interested local stakeholders to participate. The workshop will be held virtually due to COVID-19. Our meeting materials, including the PowerPoint presentation will be available on our website www.suttersubbasin.org.

Sutter Subbasin GSP – Public Workshop #3

Tuesday, Jun 15, 2021 at 6:00 pm – 8:00 pm

GoToMeeting

Please join my meeting from your computer, tablet or smartphone:
<https://global.gotomeeting.com/join/391717261>.

You can also dial in using your phone: +1 (872) 240-3212, *Access Code*: 391-717-261.

Discussion topics will include:

- Hydrogeologic Conceptual Model Update
- Review of Basin Conditions
- Mapping GDEs and Interconnected Surface Water
- Water Budgets
- Projects and Management Actions

This public workshop is a great opportunity to get involved, learn about the planning process, and provide input on the future of groundwater management in the Sutter Subbasin.

Visit our website to learn more: www.SutterSubbasin.org. You can contact either me or Leslie Dumas of Woodard & Curran via email at the addresses included on this transmittal if you have any questions.

Thank You,

Guadalupe Rivera on behalf of Sutter Subbasin GSAs
Sutter County Development Services



Learn more at www.SutterSubbasin.org



Buenas tardes,

Las nueve agencias de Sostenibilidad del Agua Subterránea (Groundwater Sustainability Agencies, GSAs) de la Subcuenca Sutter comenzaron a preparar un plan de sostenibilidad del agua subterránea (GSP) conforme a los requisitos de la Ley de Gestión Sostenible del Agua Subterránea (Sustainable Groundwater Management Act, SGMA). El GSP será terminado hacia el final del año 2021.

Invitamos a miembros de la comunidad local, organizaciones sin fines de lucro, agricultores, terratenientes, dueños de negocios, comunidades tribales, personal de agencias municipales y cualquier otro interesado local interesado a participar en nuestro taller público. Los materiales de la reunión de nuestro primer taller público se pueden encontrar en nuestro sitio web en www.suttersubbasin.org. Esta es una gran oportunidad para involucrarse, aprender sobre el proceso de planificación y brindar información sobre el futuro de la gestión del agua subterránea en la Subcuenca Sutter. El taller se realizará virtualmente debido al COVID-19. Visite nuestra página web (www.SutterSubbasin.org) para tener acceso a los materiales de la reunión.

Subcuenca Sutter GSP – Taller Público #3

martes 15 de junio de 2021 de 6pm a 8pm

GoToMeeting

Únase a nuestra reunión desde su computadora, tableta o teléfono inteligente: <https://global.gotomeeting.com/join/391717261>.

También pueden marcar con su teléfono al: 1 (872) 240-3212, *código de acceso*: 391-717-261.

Visite nuestro sitio web para obtener más información: www.SutterSubbasin.org. Puede ponerse en contacto conmigo o con Guadalupe Rivera de Conando de Sutter por correo electrónico a las direcciones incluidas en esta notificación si tiene alguna pregunta.

Gracias,

Guadalupe Rivera, en nombre de los GSAs de la Subcuenca Sutter
Servicios de Desarrollo del Condado de Sutter



Aprende más en www.SutterSubbasin.org



ਨਮਸਕਾਰ,

ਸਟਰ ਗਰਾਉਂਡ ਵਾਟਰ ਸਬਬੇਸਿਨ ਦੀਆਂ ਨੌਂ ਏਜੰਸੀਆਂ ਧਰਤੀ ਹੇਠਲੇ ਪਾਣੀ ਦੀ ਸਥਿਰਤਾ ਲਈ ਸਥਾਈ ਧਰਤੀ ਹੇਠਲਾ ਪ੍ਰਬੰਧਨ ਐਕਟ (ਐਸਜੀਐਮਏ) ਦੇ ਜਵਾਬ ਵਿੱਚ ਧਰਤੀ ਹੇਠਲੇ ਪਾਣੀ ਦੀ ਸਥਿਰਤਾ ਯੋਜਨਾ (ਜੀਐਸਪੀ) ਤਿਆਰ ਕਰਨ ਲੱਗੀਆਂ ਹਨ। ਜੀਐਸਪੀ 2021 ਦੇ ਅੰਤ ਤੱਕ ਪੂਰਾ ਹੋ ਜਾਵੇਗਾ। ਅਸੀਂ ਸਥਾਨਕ ਕਮਿਨਿਟੀ ਮੈਂਬਰਾਂ, ਗੈਰ-ਮੁਨਾਫਾ ਸੰਗਠਨਾਂ, ਕਿਸਾਨਾਂ, ਜ਼ਿਮੀਂਦਾਰਾਂ, ਕਾਰੋਬਾਰੀ ਮਾਲਕਾਂ, ਗੋਤਾਂ, ਨਗਰ ਨਿਗਮ ਏਜੰਸੀ ਦੇ ਕਰਮਚਾਰੀਆਂ ਅਤੇ ਕਿਸੇ ਵੀ ਹੋਰ ਦਿਲਚਸਪੀ ਵਾਲੇ ਸਥਾਨਕ ਹਿੱਸੇਦਾਰਾਂ ਨੂੰ ਸਾਡੀ ਜਨਤਕ ਵਰਕਸ਼ਾਪ ਵਿੱਚ ਹਿੱਸਾ ਲੈਣ ਲਈ ਸੱਦਾ ਦੇ ਰਹੇ ਹਾਂ। ਸ਼ਾਮਲ ਹੋਣ, ਯੋਜਨਾਬੰਦੀ ਪ੍ਰਕਿਰਿਆ ਬਾਰੇ ਜਾਣਨ ਅਤੇ ਸਟਰ ਸਬਬੇਸਿਨ ਵਿੱਚ ਧਰਤੀ ਹੇਠਲੇ ਪਾਣੀ ਦੇ ਪ੍ਰਬੰਧਨ ਦੇ ਭਵਿੱਖ ਬਾਰੇ ਜਾਣਕਾਰੀ ਪ੍ਰਦਾਨ ਕਰਨ ਦਾ ਇਹ ਇੱਕ ਵਧੀਆ ਮੌਕਾ ਹੈ। ਵਰਕਸ਼ਾਪ COVID-19 ਦੇ ਕਾਰਨ ਵਰਚੁਅਲੀ ਆਯੋਜਿਤ ਕੀਤੀ ਜਾਏਗੀ। ਮੀਟਿੰਗ ਦੀ ਸਮੱਗਰੀ ਸਾਡੀ ਵੈਬਸਾਈਟ 'ਤੇ ਅਪਲੋਡ ਕੀਤੀ ਜਾਏਗੀ।

ਸਟਰ ਸਬਬੇਸਿਨ ਜੀਐਸਪੀ - ਪਬਲਿਕ ਵਰਕਸ਼ਾਪ # 3

ਮੰਗਲਵਾਰ, 15 ਜੂਨ, 2021 ਸ਼ਾਮ 6 ਵਜੇ ਤੋਂ 8 ਵਜੇ ਤੱਕ ਦੀ ਤਾਰੀਖ ਯਾਦ ਰੱਖੋ

ਮੁਲਾਕਾਤ ਕਰਨ ਲਈ ਜਾਓ

ਕਿਰਪਾ ਕਰਕੇ ਆਪਣੇ ਕੰਪਿਓਟਰ, ਟੈਬਲੇਟ ਜਾਂ ਸਮਾਰਟਫੋਨ ਤੋਂ ਮੇਰੀ ਮੀਟਿੰਗ ਵਿੱਚ ਸ਼ਾਮਲ ਹੋਵੋ: <https://global.gotomeeting.com/join/391717261>.

ਤੁਸੀਂ ਆਪਣੇ ਫੋਨ ਦੀ ਵਰਤੋਂ ਕਰਕੇ ਵੀ ਡਾਇਲ ਕਰ ਸਕਦੇ ਹੋ: 1 (872) 240-3212, ਐਕਸੈਸ ਕੋਡ: 391-717-261.

ਵਧੇਰੇ ਜਾਣਨ ਲਈ ਸਾਡੀ ਵੈਬਸਾਈਟ 'ਤੇ ਜਾਓ: www.SutterSubbasin.org ਜੇ ਤੁਹਾਡੇ ਕੋਈ ਪ੍ਰਸ਼ਨ ਹਨ, ਤਾਂ ਤੁਸੀਂ ਇਸ ਸੰਚਾਰ 'ਤੇ ਸ਼ਾਮਲ ਪਤੇ 'ਤੇ ਜਾਂ ਤਾਂ ਮੇਰੇ ਜਾਂ ਵੁਡਾਰਡ ਐਂਡ ਕੁਰਾਨ ਦੇ ਲੈਸਲੀ ਡੋਮਸ ਨਾਲ ਈਮੇਲ ਰਾਹੀਂ ਸੰਪਰਕ ਕਰ ਸਕਦੇ ਹੋ।

ਤੁਹਾਡਾ ਧੰਨਵਾਦ,

ਗੁੱਡਾਲੂਪ ਰਿਵੇਰਾ ਸਟਰ ਸਬਬੇਸਿਨ ਜੀਐਸਏ ਦੀ ਤਰਫੋਂ
ਸਟਰ ਕਾਉਂਟੀ ਡਿਵੈਲਪਮੈਂਟ ਸਰਵਿਸਿਜ਼



ਵਧੇਰੇ ਜਾਣੋ www.SutterSubbasin.org



Public Workshop #3

Tuesday, June 15, 2021

Learn more at SutterSubbasin.org

The nine Groundwater Sustainability Agencies (GSAs) of Sutter Groundwater Subbasin are preparing a Groundwater Sustainability Plan (GSP) in response to the Sustainable Groundwater Management Act (SGMA). Participants are encouraged to attend and provide feedback for the Sutter Subbasin GSP.

Sutter Subbasin GSP — Public Workshop #3

Tuesday June 15, 2021 at 6:00 P.M. – 8:00 P.M.

GoToMeeting (remote/virtual)

Please join from your computer, tablet or smartphone:

 <https://global.gotomeeting.com/join/391717261>

Or dial-in:

 1 (872) 240-3212, Code: 391-717-261

Para obtener ayuda con traducción al español, comuníquese con Guadalupe Rivera a través de correo electrónico al info@suttersubbasin.org por lo menos 72 horas antes de la reunión.

ਅਨੁਵਾਦ ਸਹਾਇਤਾ ਲਈ, ਕਰਿਪਾ ਕਰਕੇ ਮੀਟਿੰਗ ਤੋਂ ਘੱਟੋ ਘੱਟ 72 ਘੰਟੇ ਪਹਿਲਾਂ info@suttersubbasin.org ਤੇ ਲੈਸਲੀ ਡੂਮਾਸ ਨਾਲ ਸੰਪਰਕ ਕਰੋ

Discussion topics will include:

- Hydrogeologic Conceptual Model Update
- Basin Conditions Update
- Mapping GDEs and Interconnected Surface Water
- Water Budgets
- Projects and Management Actions



It is important that we hear your voice, as this GSP will be used to reliably meet current and future water demands in a cost-effective and sustainable manner within your area. *Your participation is greatly appreciated!*

Preparation of the 2022 Sutter Subbasin Groundwater Sustainability Plan is underway.

The nine Groundwater Sustainability Agencies of Sutter Groundwater Subbasin are preparing a Groundwater Sustainability Plan (GSP) in response to the Sustainable Groundwater Management Act (SGMA). In 2014, California enacted the SGMA to provide a framework for long-term sustainable groundwater management across California. The Sutter Subbasin is part of the Sacramento Valley Groundwater Basin and will submit a GSP to the State no later than January 31, 2022.

Sutter Subbasin GSP - Public Workshop 8/11/21

All meetings will be held virtually due to COVID-19 until further notice. Visit our website for more information.

GET INVOLVED! To sign up for our stakeholder list or learn more information visit our website.

SutterSubbasin.org

Aviso

Preparación del Plan de Sostenibilidad del Agua Subterránea (GSP) de la Subcuenca Sutter ha comenzado.

Las nueve agencias de Sostenibilidad del Agua Subterránea de la Subcuenca Sutter están comenzando a preparar un plan de GSP conforme a los requisitos de la Ley de Gestión Sostenible del Agua Subterránea (Sustainable Groundwater Management Act, SGMA). En 2014, California promulgó SGMA para proporcionar pautas para la gestión sostenible de las aguas subterráneas a largo plazo en todo California. La Subcuenca Sutter es parte de la Cuenca de Aguas Subterráneas del Valle de Sacramento y presentará un GSP al Estado a más tardar el 31 de enero de 2022.

Subcuenca Sutter GSP - Taller Público 8/11/21

Debido a COVID-19, todas las reuniones se llevarán a cabo virtualmente hasta nuevo aviso.

¡INVOLÚCRATE! Visite nuestro sitio web y regístrate para obtener más información.

SutterSubbasin.org

ਨੋਟਿਸ

2022 ਦੀ ਸਟਰ ਸਬਬੇਸਨਿ ਧਰਤੀ ਹੇਠਲੇ ਪਾਣੀ ਦੀ ਸਥਰਿਤਾ ਯੋਜਨਾ ਦੀ ਤਿਆਰੀ ਚੱਲ ਰਹੀ ਹੈ।

ਸਟਰ ਗਰਾਊਂਡ ਵਾਟਰ ਸਬਬੇਸਨਿ ਦੀਆਂ ਨੌਂ ਏਜੰਸੀਆਂ ਧਰਤੀ ਹੇਠਲੇ ਪਾਣੀ ਦੀ ਸਥਰਿਤਾ ਲਈ 'ਸਥਾਈ ਧਰਤੀ ਹੇਠਲਾ ਪ੍ਰਬੰਧਨ ਐਕਟ' (ਐਸਜੀਐਮਏ) ਦੇ ਜਵਾਬ ਵੱਜੋਂ ਧਰਤੀ ਹੇਠਲੇ ਪਾਣੀ ਦੀ ਸਥਰਿਤਾ ਯੋਜਨਾ (ਜੀਐਸਪੀ) ਤਿਆਰ ਕਰਨ ਲੱਗੀਆਂ ਹਨ। 2014 ਵੱਜੋਂ ਕੈਲੀਫੋਰਨੀਆ ਨੇ ਕੈਲੀਫੋਰਨੀਆ ਵੱਜੋਂ ਲੰਬੇ ਸਮੇਂ ਲਈ ਟੁਕਿਣ ਵਾਲੇ ਧਰਤੀ ਹੇਠਲੇ ਪਾਣੀ ਪ੍ਰਬੰਧਨ ਲਈ ਇੱਕ ਢਾਂਚਾ ਪ੍ਰਦਾਨ ਕਰਨ ਲਈ ਐਸਜੀਐਮਏ ਨੂੰ ਲਾਗੂ ਕੀਤਾ। ਸਟਰ ਸਬਬੇਸਨਿ ਸੈਕਰਾਮੈਂਟੋ ਵੈਲੀ ਗਰਾਊਂਡ ਵਾਟਰ ਬੇਸਨਿ ਦਾ ਹੱਸਿਾ ਹੈ ਅਤੇ 31 ਜਨਵਰੀ, 2022 ਤੱਕ ਕੈਲੀਫੋਰਨੀਆ ਸਟੇਟ ਨੂੰ ਜੀਐਸਪੀ ਤਿਆਰ ਕਰਕੇ ਦੇਵੇਗਾ।

ਸਟਰ ਸਬਬੇਸਨਿ ਜੀਐਸਪੀ - ਪਬਲਿਕ ਵਰਕਸ਼ਾਪ 8/11/21

ਅਗਲੀਆਂ ਸੂਚਨਾਵਾਂ ਤਕ ਸਾਰੀਆਂ ਮੀਟਿੰਗਾਂ ਵਰਚੁਅਲ ਹੋਣਗੀਆਂ। ਵਧੇਰੇ ਜਾਣਕਾਰੀ ਲਈ ਸਾਡੀ ਵੈਬਸਾਈਟ ਵੇਖੋ

ਸ਼ਾਮਲ ਹੋਵੋ! ਸਾਡੇ ਹੱਸਿਦਾਰਾਂ ਦੀ ਸੂਚੀ ਲਈ ਸਾਈਨ-ਅਪ ਕਰਨ ਜਾਂ ਵਧੇਰੇ ਜਾਣਕਾਰੀ ਲਈ ਸਾਡੀ ਵੈਬਸਾਈਟ ਤੇ ਜਾਓ

SutterSubbasin.org



Please **save the date** for our fourth public workshop for the 2022 *Sutter Subbasin Groundwater Sustainability Plan* on **Wednesday, August 11, 2021 from 4 pm to 6 pm**. We encourage all local community members, non-profit organizations, farmers, landowners, business owners, tribal communities, municipal agency staffers, and any other interested local stakeholders to participate.

The workshop will be held virtually due to COVID-19.

Sutter Subbasin GSP – Public Workshop #4

Wednesday, August 11, 2021 at 4:00 pm – 6:00 pm

GoToMeeting

Please join my meeting from your computer, tablet or smartphone:

<https://global.gotomeeting.com/join/668712749>.

You can also dial in using your phone: +1 (224) 501-3412, *Access Code: 668-712-749*

Discussion topics will include:

- Sustainable Management Criteria
- Water Budgets with Projects and Management Actions
- Monitoring Networks
- Sustainable Yield Estimate
- Groundwater Sustainability Plan Implementation

The nine Groundwater Sustainability Agencies (GSAs) of Sutter Groundwater Subbasin have been preparing a Groundwater Sustainability Plan (GSP) in response to the Sustainable Groundwater Management Act (SGMA). The GSP will be complete by the end of 2021. This public workshop is a great opportunity to get involved, learn about the planning process, and provide input on the future of groundwater management in the Sutter Subbasin.

Visit our website to learn more: www.SutterSubbasin.org. You can contact either me or Leslie Dumas of Woodard & Curran via email at the addresses included on this transmittal if you have any questions.

Thank You,

Guadalupe Rivera on behalf of Sutter Subbasin GSAs
Sutter County Development Services



Learn more at www.SutterSubbasin.org



Por favor **reserve la fecha** para nuestro tercer taller público para el *Plan de Sostenibilidad del Agua Subterránea de la Subcuenca Sutter del 2022*, el **miércoles 11 de agosto de 2021 de 4pm a 6pm**. Alentamos a todos los miembros de la comunidad local, organizaciones sin fines de lucro, agricultores, terratenientes, dueños de negocios, comunidades tribales, personal de agencias municipales y cualquier otro interesado local a participar.

El taller se realizará virtualmente debido a COVID-19.

Sutter Subbasin GSP – Public Workshop #4
miércoles, 11 de agosto de 2021 de 4pm – 6pm
GoToMeeting

Únase a nuestra reunión desde su computadora, tableta o teléfono inteligente: <https://global.gotomeeting.com/join/668712749>.

También pueden marcar con su teléfono al: (224) 501-3412, *código de acceso*: 668-712-749

Las nueve Agencias de Sostenibilidad de Agua Subterránea (GSA) de la Subcuenca de Sutter de Agua Subterránea han estado preparando un Plan de Sostenibilidad de Agua Subterránea (GSP) en respuesta a la Ley de Gestión Sostenible del Agua Subterránea (SGMA). El GSP estará completo a fines de 2021.

Este taller público es una gran oportunidad para involucrarse, aprender sobre el proceso de planificación y brindar su opinión sobre el futuro de la gestión del agua subterránea en la Subcuenca Sutter.

Visite nuestro sitio web para obtener más información: www.SutterSubbasin.org. Puede ponerse en contacto conmigo o con Guadalupe Rivera de Conando de Sutter por correo electrónico a las direcciones incluidas en esta notificación si tiene alguna pregunta.

Gracias,

Guadalupe Rivera, en nombre de los GSAs de la Subcuenca Sutter
Servicios de Desarrollo del Condado de Sutter



Aprende más en www.SutterSubbasin.org



ਕਿਰਪਾ ਕਰਕੇ 2022 ਦੀ ਸਟਰ ਸਬਬੇਸਿਨ ਧਰਤੀ ਹੇਠਲੇ ਪਾਣੀ ਦੀ ਸਥਿਰਤਾ ਯੋਜਨਾ ਲਈ ਸਾਡੀ ਤੀਜੀ ਪਬਲਿਕ ਵਰਕਸ਼ਾਪ ਦੇ ਲਈ ਸੋਮਵਾਰ, 14 ਦਸੰਬਰ, 2021 ਸ਼ਾਮ 4:00 ਵਜੇ - ਸ਼ਾਮ 6 ਵਜੇ ਅਸੀਂ ਸਾਰੇ ਸਥਾਨਕ ਭਾਈਚਾਰੇ ਦੇ ਮੈਂਬਰਾਂ, ਗੈਰ-ਲਾਭਕਾਰੀ ਸੰਗਠਨਾਂ, ਕਿਸਾਨਾਂ, ਜ਼ਿਮੀਂਦਾਰਾਂ, ਕਾਰੋਬਾਰੀ ਮਾਲਕਾਂ, ਕਬਾਇਲੀ ਭਾਈਚਾਰਿਆਂ, ਮਿਊਂਸੀਪਲ ਏਜੰਸੀ ਦੇ ਕਰਮਚਾਰੀਆਂ ਅਤੇ ਕਿਸੇ ਹੋਰ ਦਿਲਚਸਪੀ ਰੱਖਣ ਵਾਲੇ ਸਥਾਨਕ ਹਿੱਸੇਦਾਰਾਂ ਨੂੰ ਭਾਗ ਲੈਣ ਲਈ ਬੇਨਤੀ ਕੇਵਿਡ-19 ਦੇ ਕਾਰਨ ਵਰਕਸ਼ਾਪ ਵਰਚੁਅਲ ਤੌਰ ਤੇ ਆਯੋਜਿਤ ਕੀਤੀ ਜਾਵੇਗੀ ਏਜੰਡਾ ਜਿਸ ਦੀ ਪਾਲਣਾ ਕਰਨੀ ਹੈ।

ਸਟਰ ਸਬਬੇਸਿਨ ਜੀਐਸਪੀ - ਪਬਲਿਕ ਵਰਕਸ਼ਾਪ # 4

ਬੁੱਧਵਾਰ, 11 ਅਗਸਤ, 2021 ਸ਼ਾਮ 4 ਵਜੇ - ਸ਼ਾਮ 6 ਵਜੇ

ਮੁਲਾਕਾਤ ਕਰਨ ਲਈ ਜਾਓ

ਕਿਰਪਾ ਕਰਕੇ ਆਪਣੇ ਕੰਪਿਓਟਰ, ਟੈਬਲੇਟ ਜਾਂ ਸਮਾਰਟਫੋਨ ਤੋਂ ਮੇਰੀ ਮੀਟਿੰਗ ਵਿੱਚ ਸ਼ਾਮਲ

ਜ਼ੋਏ: <https://global.gotomeeting.com/join/668712749>

ਤੁਸੀਂ ਆਪਣੇ ਫੋਨ ਦੀ ਵਰਤੋਂ ਕਰਕੇ ਵੀ ਡਾਇਲ ਕਰ ਸਕਦੇ ਹੋ: (224) 501-3412, ਐਕਸੈਸ ਕੋਡ: 668-712-749

ਸਟਰ ਸਬਬੇਸਿਨ ਧਰਤੀ ਹੇਠਲੇ ਪਾਣੀ ਦੀਆਂ ਨੌਂ ਧਰਤੀ ਹੇਠਲੇ ਪਾਣੀ ਦੀ ਸਥਿਰਤਾ ਦੀਆਂ ਏਜੰਸੀਆਂ (GSAs) ਧਰਤੀ ਹੇਠਲੇ ਪਾਣੀ ਦਾ ਟਿਕਾਊ ਪ੍ਰਬੰਧਨ ਐਕਟ (SGMA) ਦੇ ਜਵਾਬ ਵਿੱਚ ਧਰਤੀ ਹੇਠਲੇ ਪਾਣੀ ਦੀ ਸਥਿਰਤਾ ਯੋਜਨਾ (GSP) ਤਿਆਰ ਕਰ ਰਹੀਆਂ ਹਨ। GSP 2021 ਦੇ ਅੰਤ ਤੱਕ ਪੂਰਾ ਹੋ ਜਾਵੇਗਾ। ਇਹ ਜਨਤਕ ਵਰਕਸ਼ਾਪ ਸ਼ਾਮਲ ਹੋਣ, ਯੋਜਨਾਬੰਦੀ ਪ੍ਰਕਿਰਿਆ ਬਾਰੇ ਜਾਣਨ ਅਤੇ ਸਟਰ ਸਬਬੇਸਿਨ ਵਿੱਚ ਧਰਤੀ ਹੇਠਲੇ ਪਾਣੀ ਦੇ ਪ੍ਰਬੰਧਨ ਦੇ ਭਵਿੱਖ ਬਾਰੇ ਸੁਝਾਅ ਪੇਸ਼ ਕਰਨ ਦਾ ਇੱਕ ਵਧੀਆ ਮੌਕਾ

ਦਫ਼ਤੇ ਜਾਣਨ ਲਈ ਸਾਡੀ ਵੈਬਸਾਈਟ ਤੇ ਜਾਓ: www.SutterSubbasin.org ਜੇ ਤੁਹਾਡੇ ਕੋਈ ਪ੍ਰਸ਼ਨ ਹਨ, ਤਾਂ ਤੁਸੀਂ ਇਸ ਸੰਚਾਰ 'ਤੇ ਸ਼ਾਮਲ ਪਤੇ' ਤੇ ਜਾਂ ਤਾਂ ਮੇਰੇ ਜਾਂ ਵੁਡਾਰਡ ਐਂਡ ਕੁਰਾਨ ਦੇ ਲੈਸਲੀ ਡੇਮਸ ਨਾਲ ਈਮੇਲ ਰਾਹੀਂ ਸੰਪਰਕ ਕਰ ਸਕਦੇ ਹੋ।

ਤੁਹਾਡਾ ਧੰਨਵਾਦ,

ਗੁੱਡਾਲੁਪ ਰਿਵੇਰਾ ਸਟਰ ਸਬਬੇਸਿਨ ਜੀਐਸਏ ਦੀ ਤਰਫੋਂ
ਸਟਰ ਕਾਉਂਟੀ ਡਿਵੈਲਪਮੈਂਟ ਸਰਵਿਸਿਜ਼



ਵਧੇਰੇ ਜਾਣੋ www.SutterSubbasin.org



Public Workshop #4

Wednesday, August 11, 2021

Learn more at SutterSubbasin.org

The nine Groundwater Sustainability Agencies (GSAs) of Sutter Groundwater Subbasin are preparing a Groundwater Sustainability Plan (GSP) in response to the Sustainable Groundwater Management Act (SGMA). Participants are encouraged to attend and provide feedback for the Sutter Subbasin GSP.

Sutter Subbasin GSP — Public Workshop #4

Wednesday August 11, 2021 at 4:00 P.M - 6:00 P.M.

GoToMeeting (remote/virtual)

Please join from your computer, tablet or smartphone:

 <https://global.gotomeeting.com/join/668712749>

Or dial-in:

 1 (224) 501-3412, Code: 668-712-749

Discussion topics will include:

- Sustainable Management Criteria
- Water Budgets with Projects and Management Actions
- Monitoring Networks
- Sustainable Yield Estimate
- Groundwater Sustainability Plan Implementation

Para obtener ayuda con traducción al español, comuníquese con Guadalupe Rivera a través de correo electrónico al info@suttersubbasin.org por lo menos 72 horas antes de la reunión.

ਅਨੁਵਾਦ ਸਹਾਇਤਾ ਲਈ, ਕਰਿਪਾ ਕਰਕੇ ਮੀਟਿੰਗ ਤੋਂ ਘੱਟੋ ਘੱਟ 72 ਘੰਟੇ ਪਹਿਲਾਂ info@suttersubbasin.org ਤੇ ਲੈਸਲੀ ਡੂਮਾਸ ਨਾਲ ਸੰਪਰਕ ਕਰੋ



It is important that we hear your voice, as this GSP will be used to reliably meet current and future water demands in a cost-effective and sustainable manner within your area. *Your participation is greatly appreciated!*

This page intentionally left blank.

Preparation of the 2022 Sutter Subbasin Groundwater Sustainability Plan is underway.

The nine Groundwater Sustainability Agencies of Sutter Groundwater Subbasin are preparing a Groundwater Sustainability Plan (GSP) in response to the Sustainable Groundwater Management Act (SGMA). In 2014, California enacted the SGMA to provide a framework for long-term sustainable groundwater management across California. The Sutter Subbasin is part of the Sacramento Valley Groundwater Basin and will submit a GSP to the State no later than January 31, 2022.

Sutter Subbasin GSP - Public Workshop 10/19/21

All meetings will be held virtually due to COVID-19 until further notice. Visit our website for more information.

GET INVOLVED! *To sign up for our stakeholder list or learn more information visit our website.*

SutterSubbasin.org

Public Comment Period - 10/1/21 to 11/12/21

The Public Draft GSP will be available October 1st at www.SutterSubbasin.org. Comments can be submitted to info@suttersubbasin.org.

Ya está en marcha la preparación del Plan de sostenibilidad del agua subterránea de la Subcuenca de Sutter 2022.

Las nueve Agencias de sostenibilidad del agua subterránea (Groundwater Sustainability Agencies, GSA) de la Subcuenca de agua subterránea de Sutter están preparando un Plan de sostenibilidad del agua subterránea (Groundwater Sustainability Plan, GSP) en respuesta a la Ley de gestión sostenible del agua subterránea (Sustainable Groundwater Management Act, SGMA). En 2014, California promulgó la SGMA para proporcionar un marco a largo plazo para la gestión sostenible del agua subterránea en California. La Subcuenca de Sutter es parte de la Cuenca de agua subterránea del Valle de Sacramento y presentará un GSP al Estado a más tardar el 31 de enero de 2022.

Taller público sobre el GSP de la Subcuenca de Sutter el 10/19/21

Todas las reuniones se realizarán virtualmente debido a la COVID-19 hasta nuevo aviso. Visite nuestro sitio web para obtener más información.

¡PARTICIPE! *Para inscribirse en nuestra lista de actores interesados o para obtener más información visite nuestro sitio web.*

SutterSubbasin.org

Periodo de comentario público - 10/1/21 a 11/12/21

El borrador público del GSP estará disponible el 1º de octubre en www.SutterSubbasin.org. Los comentarios pueden enviarse a info@suttersubbasin.org.

2022 ਸਟਰ ਸਬਬੇਸਨਿ ਦੀ ਤਿਆਰੀ ਗ੍ਰਾਊਡਵਾਟਰ ਸਸਟੇਨੇਬਲਟੀ ਪਲਾਨ ਪ੍ਰਕਰਿਆ ਵੱਚਿ ਹੈ।

ਸਟਰ ਗ੍ਰਾਊਡਵਾਟਰ ਸਬਬੇਸਨਿ ਦੀਆਂ ਨੌਂ ਗ੍ਰਾਊਡਵਾਟਰ ਸਸਟੇਨੇਬਲਟੀ ਏਜੰਸੀਆਂ ਸਸਟੇਨੇਬਲ ਗ੍ਰਾਊਡਵਾਟਰ ਮੈਨੇਜਮੈਂਟ ਐਕਟ (SGMA) ਦੀ ਪ੍ਰਤੀਕਰਿਆ ਵੱਚਿ ਗ੍ਰਾਊਡਵਾਟਰ ਸਸਟੇਨੇਬਲਟੀ ਪਲਾਨ (GSP) ਤਿਆਰ ਕਰ ਰਹੀਆਂ ਹਨ। 2014 ਵੱਚਿ, ਕੈਲੀਫੋਰਨੀਆ ਨੇ ਕੈਲੀਫੋਰਨੀਆ ਵੱਚਿ ਦੀਰਘਕਾਲੀਨ ਚਰਿਕਾਲੀਨ ਭੂਮੀਗਤ ਜਲ ਲਈ ਇੱਕ ਰੂਪ-ਰੇਖਾ ਦੇਣ ਲਈ SGMA ਨੂੰ ਅਧਿਨਿਯਮਿਤ ਕੀਤਾ ਹੈ। ਦ ਸਟਰ ਸਬਬੇਸਨਿ ਸੈਕਰਾਮੈਂਟੋ ਵੈਲੀ ਗ੍ਰਾਊਡਵਾਟਰ ਬੇਸਨਿ ਦਾ ਇੱਕ ਹੱਸਿ ਹੈ ਅਤੇ ਇਹ 31 ਜਨਵਰੀ, 2022 ਤੱਕ ਰਾਜ ਨੂੰ GSP ਸਬਮਿਟ ਕਰੇਗਾ।

ਸਟਰ ਸਬਬੇਸਨਿ GSP ਪਬਲਕਿ ਵਰਕਸ਼ੱਪ 10/19/21

ਅਗਲੀਆਂ ਸੂਚਨਾਵਾਂ ਤਕ ਸਾਰੀਆਂ ਮੀਟਿੰਗਾਂ ਵਰਚੁਅਲ ਹੋਣਗੀਆਂ।
ਵਧੇਰੇ ਜਾਣਕਾਰੀ ਲਈ ਸਾਡੀ ਵੈੱਬਸਾਈਟ ਵੇਖੋ

ਸ਼ਾਮਲਿ ਹੋ ਜਾਓ! ਸਾਡੇ ਹੱਸਿਦਾਰ ਸੂਚੀ
ਲਈ ਸਾਇਨ ਅਪ ਕਰਨ ਲਈ ਜਾਂ ਜਾਣਨ
ਲਈ ਸਾਡੀ ਵੈੱਬਸਾਈਟ 'ਤੇ ਜਾਓ।

SutterSubbasin.org

ਪਬਲਕਿ ਕੁਮੈਂਟ ਪੀਰੀਅਡ - 10/1/21 ਤੋਂ 11/12/21

ਪਬਲਕਿ ਡ੍ਰਾਫਟ GSP 1 ਅਕਤੂਬਰ ਤੋਂ www.SutterSubbasin.org 'ਤੇ ਉਪਲਬਧ ਹੋਵੇਗਾ। ਟੱਪਿਣੀਆਂ
info@suttersubbasin.org 'ਤੇ ਸਬਮਿਟ ਕੀਤੀਆਂ ਜਾ ਸਕਦੀਆਂ ਹਨ।

This page intentionally left blank.



Good morning,

Please **save the date** for our fifth public workshop for the 2022 *Sutter Subbasin Groundwater Sustainability Plan* on **Tuesday, October 19, 2021 from 4pm to 6pm**. We encourage all local community members, non-profit organizations, farmers, landowners, business owners, tribal communities, municipal agency staffers, and any other interested local stakeholders to participate.

The workshop will be held virtually due to COVID-19. Agenda to follow.

The nine Groundwater Sustainability Agencies (GSAs) of Sutter Groundwater Subbasin have been preparing a Groundwater Sustainability Plan (GSP) in response to the Sustainable Groundwater Management Act (SGMA). The GSP will be complete by the end of 2021 and submitted to the State prior to the January 31, 2022 deadline. This public workshop is a great opportunity to get involved, learn about the contents of the Sutter Subbasin GSP, and provide input on the future of groundwater management in the Sutter Subbasin.

Visit our website to learn more: www.SutterSubbasin.org. You can contact either me or Leslie Dumas of Woodard & Curran via email at the addresses included on this transmittal if you have any questions.

Thank You,

Guadalupe Rivera on behalf of Sutter Subbasin GSAs
Sutter County Development Services



Learn more at www.SutterSubbasin.org



Buenos días,

Por favor **anote la fecha** de nuestro quinto taller público sobre el *Plan de sostenibilidad del agua subterránea para la Subcuenca de Sutter 2022* el **martes, 19 de octubre de 2021 de 4 pm a 6 pm**. Animamos a participar a todos los miembros de la comunidad, organizaciones sin fines de lucro, agricultores, hacendados, propietarios de negocios, comunidades tribales, personal de agencias municipales y otros actores interesados locales.

El taller se realizará virtualmente debido a la COVID-19. Agenda a seguir.

Las nueve Agencias de sostenibilidad del agua subterránea (Groundwater Sustainability Agencies, GSA) de la Subcuenca de agua subterránea de Sutter han estado preparando un Plan de sostenibilidad del agua subterránea (Groundwater Sustainability Plan, GSP) en respuesta a la Ley de gestión sostenible del agua subterránea (Sustainable Groundwater Management Act, SGMA). El GSP estará completo para finales de 2021 y se presentará al Estado antes de la fecha límite del 31 de enero de 2022. Este taller público es una excelente oportunidad para involucrarse, aprender sobre los contenidos del GSP de la Subcuenca de Sutter y dar su opinión sobre el futuro de la gestión del agua subterránea en la Subcuenca de Sutter.

Visite nuestro sitio web para aprender más: www.SutterSubbasin.org. Puede ponerse en contacto conmigo o con Leslie Dumas de Woodward & Curran por correo electrónico a las direcciones incluidas en este mensaje si tiene alguna pregunta.

Gracias,

Guadalupe Rivera, en nombre de las GSA de la Subcuenca de Sutter
Servicios de desarrollo del Condado de Sutter



Puede encontrar más información en www.SutterSubbasin.org



ਸੁੱਭ ਸਵੇਰ,

ਕਿਰਪਾ ਕਰਕੇ ਮੰਗਲਵਾਰ, 19 ਅਕਤੂਬਰ, 2021 ਨੂੰ ਸ਼ਾਮ 4 ਤੋਂ 6 ਵਜੇ ਤੱਕ 2022 ਸਟਰ ਸਬਬੇਸਿਨ ਗ੍ਰਾਊਂਡਵਾਟਰ ਸਸਟੇਨੇਬਲਿਟੀ ਪਲਾਨ ਲਈ ਸਾਡੀ ਪੰਜਵੀਂ ਪਬਲਿਕ ਵਰਕਸ਼ਾਪ ਲਈ ਤਾਰੀਖ ਸੇਵ ਕਰੋ। ਅਸੀਂ ਹਿੱਸਾ ਲੈਣ ਵਾਲੇ ਸਾਰੇ ਸਮੁਦਾਇਕ ਕਮਿਊਨਿਟੀ ਮੈਂਬਰ, ਗੈਰ-ਲਾਭ ਸੰਗਠਨ, ਕਿਸਾਨ, ਜ਼ਮੀਂਦਾਰ, ਬਿਜਨਿਸ ਮਾਲਿਕ, ਕਬੀਲਾ ਸਮੁਦਾਇ, ਨਗਰਪਾਲਿਕਾ ਏਜੰਸੀ ਸਟਾਫ਼ਰ, ਅਤੇ ਕੋਈ ਹੋਰ ਚਾਹਵਾਨ ਸਥਾਨਕ ਹਿੱਸੇਦਾਰ ਨੂੰ ਉਤਸ਼ਾਹਿਤ ਕਰਦੇ ਹਾਂ।

ਕੋਵਿਡ-19 ਕਾਰਨ ਵਰਕਸ਼ਾਪ ਵਰਚੁਅਲੀ ਹੋਵੇਗੀ। ਫਾਲੋ ਕਰਨ ਲਈ ਏਜੰਡਾ।

ਸਟਰ ਗ੍ਰਾਊਂਡਵਾਟਰ ਸਬਬੇਸਿਨ ਦੀਆਂ ਨੌਂ ਗ੍ਰਾਊਂਡਵਾਟਰ ਸਸਟੇਨੇਬਲਿਟੀ ਏਜੰਸੀਆਂ (GSAs) ਸਸਟੇਨੇਬਲ ਗ੍ਰਾਊਂਡਵਾਟਰ ਮੈਨੇਜਮੈਂਟ ਐਕਟ (SGMA) ਦੀ ਪ੍ਰਤੀਕਿਰਿਆ ਵਿੱਚ ਗ੍ਰਾਊਂਡਵਾਟਰ ਸਸਟੇਨੇਬਲਿਟੀ ਪਲਾਨ (GSP) ਤਿਆਰ ਕਰ ਰਹੀਆਂ ਹਨ। GSP 2021 ਦੇ ਅੰਤ ਤੱਕ ਪੂਰਾ ਹੋ ਜਾਵੇਗਾ ਅਤੇ ਇਹ 31 ਜਨਵਰੀ, 2022 ਦੀ ਸਮਾਂ-ਸੀਮਾ ਤੋਂ ਪਹਿਲਾਂ ਰਾਜ ਨੂੰ ਸਬਮਿਟ ਕੀਤਾ ਜਾਵੇਗਾ। ਇਹ ਪਬਲਿਕ ਵਰਕਸ਼ਾਪ ਸ਼ਾਮਲ ਹੋਣ, ਸਟਰ ਸਬਬੇਸਿਨ GSP ਦੀ ਸਮੱਗਰੀ ਬਾਰੇ ਸਿੱਖਣ ਦਾ ਵਧੀਆ ਮੌਕਾ ਹੈ ਅਤੇ ਸਟਰ ਸਬਬੇਸਿਨ ਵਿੱਚ ਗ੍ਰਾਊਂਡਵਾਟਰ ਮੈਨੇਜਮੈਂਟ ਦੇ ਭਵਿੱਖ 'ਤੇ ਇਨਪੁਟ ਦੇਵੇਗਾ।

ਜ਼ਿਆਦਾ ਜਾਣਨ ਲਈ ਸਾਡੀ ਵੈਬਸਾਈਟ: www.SutterSubbasin.org 'ਤੇ ਜਾਓ। ਤੁਸੀਂ ਜਾਂ ਤਾਂ ਮੇਰੇ ਨਾਲ ਜਾਂ ਲੀਸੀਲੇ ਦੂਮਾਸ ਆੱਫ਼ ਵੁਡਾਰਡ ਅਤੇ ਕੁਰੈਨ ਨਾਲ ਇਸ ਪ੍ਰਸਾਰਣ 'ਤੇ ਸ਼ਾਮਲ ਪਤੇ 'ਤੇ ਈਮੇਲ ਕਰ ਸਕਦੇ ਹੋ।

ਧੰਨਵਾਦ,

ਸਟਰ ਸਬਬੇਸਿਨ GSAs ਵੱਲੋਂ ਗੁਆਡਾਲਪੇ ਰਿਵੇਰਾ

ਸਟਰ ਕਾਉਂਟੀ ਡਵੈਲਪਮੈਂਟ ਸਰਵਿਸਿਜ਼



ਜ਼ਿਆਦਾ ਜਾਣਕਾਰੀ ਲਈ www.SutterSubbasin.org 'ਤੇ ਜਾਓ



Public Workshop #5

Tuesday, October 19, 2021

Learn more at SutterSubbasin.org

The nine Groundwater Sustainability Agencies (GSAs) of Sutter Groundwater Subbasin are preparing a Groundwater Sustainability Plan (GSP) in response to the Sustainable Groundwater Management Act (SGMA). Participants are encouraged to attend and provide feedback for the Sutter Subbasin GSP.

Sutter Subbasin GSP — Public Workshop #5

Tuesday, October 19, 2021 at 4:00 P.M. – 6:00 P.M.

GoToMeeting (remote/virtual)

Please join from your computer, tablet or smartphone:

 <https://global.gotomeeting.com/join/214694605>

Or dial-in:

 1 (408) 650-3123, Code: 214-694-605

Discussion topics will include:

- An overview of the Public Draft GSP
- Public Comment Period (open from October 1 through November 12)
- GSP Adoption and Submittal timing

Para obtener ayuda con traducción al español, comuníquese con Guadalupe Rivera a través de correo electrónico al info@suttersubbasin.org por lo menos 72 horas antes de la reunión.

ਅਨੁਵਾਦ ਸਹਾਇਤਾ ਲਈ, ਕਰਿਪਾ ਕਰਕੇ ਮੀਟਿੰਗ ਤੋਂ ਘੱਟੋ ਘੱਟ 72 ਘੰਟੇ ਪਹਿਲਾਂ info@suttersubbasin.org ਤੇ ਲੈਸਲੀ ਡੂਮਾਸ ਨਾਲ ਸੰਪਰਕ ਕਰੋ



It is important that we hear your voice, as this GSP will be used to reliably meet current and future water demands in a cost-effective and sustainable manner within your area. *Your participation is greatly appreciated!*



Chapters of the Sutter Subbasin Groundwater Sustainability Plan are Available for Review!

The nine Groundwater Sustainability Agencies (GSAs) of Sutter Groundwater Subbasin have been preparing a Groundwater Sustainability Plan (GSP) in response to the Sustainable Groundwater Management Act (SGMA). Chapters will be released for public review as they are available. The first two chapters of the GSP are now available to download.

- Both the **Plan Area** and **Governance** chapters have been posted to the [Sutter Subbasin GSP website](https://www.suttersubbasin.org) for public review. Both chapters can be downloaded on the Resources page [here](#).
- The public **comment period is open until May 17, 2021**.
- Please email public comments to info@suttersubbasin.org and include "Sutter Subbasin GSP Plan Area and Governance comments" in the subject line.

Visit our website to learn more: www.SutterSubbasin.org. You can contact either me or Leslie Dumas of Woodard & Curran via email at the addresses included on this transmittal if you have any questions.

Additionally, we invite you to Save the Date for our third public workshop on June 15, 2021 from 6:00 pm to 8:00 pm.

Thank You,

Guadalupe Rivera on behalf of Sutter Subbasin GSAs
Sutter County Development Services



Learn more at www.SutterSubbasin.org



A Chapter of the Sutter Subbasin Groundwater Sustainability Plan is Available for Review!

The nine Groundwater Sustainability Agencies (GSAs) of Sutter Groundwater Subbasin have been preparing a Groundwater Sustainability Plan (GSP) in response to the Sustainable Groundwater Management Act (SGMA). Chapters will be released for public review as they are available. The first two chapters of the GSP were released in April; the comment period on these chapters closed in May. An additional chapter is now available to download and review. The plan will be released in its entirety in October for review.

- The **Hydrogeologic Conceptual Model** section of the Basin Setting Chapter (Section 5.1) has been posted to the [Sutter Subbasin GSP website](#) for public review and can be downloaded on the Resources page [here](#).
- The public **comment period is open until August 9, 2021**.
- Please email public comments to info@suttersubbasin.org and include "Sutter Subbasin GSP HCM comments" in the subject line.

Visit our website to learn more: www.SutterSubbasin.org. You can contact either me or Leslie Dumas of Woodard & Curran via email at the addresses included on this transmittal if you have any questions.

Additionally, we invite you **to Save the Date for our fourth public workshop on August 11, 2021** from 4:00 pm to 6:00 pm. This is presently scheduled to be a virtual workshop.

Thank You,

Guadalupe Rivera on behalf of Sutter Subbasin GSAs
Sutter County Development Services



Learn more at www.SutterSubbasin.org



A Chapter of the Sutter Subbasin Groundwater Sustainability Plan is Available for Review!

The nine Groundwater Sustainability Agencies (GSAs) of Sutter Groundwater Subbasin have been preparing a Groundwater Sustainability Plan (GSP) in response to the Sustainable Groundwater Management Act (SGMA). Chapters will be released for public review as they are available. The first two chapters of the GSP were released in April; the comment period on these chapters closed in May. An additional chapter is now available to download and review. The plan will be released in its entirety in October for review.

- The **Groundwater Conditions** section of the Basin Setting Chapter (Section 5.2) has been posted to the [Sutter Subbasin GSP website](http://www.SutterSubbasin.org) for public review and can be downloaded on the Resources page [here](#).
- The public **comment period is open until August 27, 2021**.
- Please email public comments to info@suttersubbasin.org and include "Sutter Subbasin GSP Groundwater Conditions comments" in the subject line.

Visit our website to learn more: www.SutterSubbasin.org. You can contact either me or Leslie Dumas of Woodard & Curran via email at the addresses included on this transmittal if you have any questions.

Additionally, we invite you **to Save the Date for our fourth public workshop on August 11, 2021** from 4:00 pm to 6:00 pm. This is presently scheduled to be a virtual workshop.

Thank You,

Guadalupe Rivera on behalf of Sutter Subbasin GSAs
Sutter County Development Services



Learn more at www.SutterSubbasin.org



Sutter Subbasin <info@suttersubbasin.org>

NOTICE (Aviso/नोटिस): The Sutter Subbasin Groundwater Sustainability Plan Public Draft is Available for Review!

Sutter Subbasin <info@suttersubbasin.org>

Fri, Oct 1, 2021 at 10:47 AM

Cc: Guadalupe Rivera <grivera@co.sutter.ca.us>, Leslie Dumas <ldumas@woodardcurran.com>, vdeanda@woodardcurran.com, Natalie Cochran <ncochran@woodardcurran.com>

Bcc: Guadalupe Rivera <Grivera@co.sutter.ca.us>, morme@buttewater.net, scrolls@rarcivil.com, lphillips@sutterewd.com, sutterwater@aol.com, kwillis@yubacity.net, aduffey@succeed.net, brad@sutterbasinwater.com, jon@montnafarms.com, jtfdwd@yahoo.com, dd49erdd@yahoo.com, Pschubert@gswater.com, Colleen@buttefarmbureau.com, Cbuck@buttecounty.net, lhunter@countyofglenn.net, sstockton@countyofglenn.net, bryce@lundberg.com, mfahey@countyofcolusa.com, pgosselin@buttecounty.net, cbuck@buttecounty.net, kpeterson@buttecounty.net, caikens@yubawater.org, smatyac@yubawater.org, justine@ysfarmbureau.com, yuba-sutterfb@sbcglobal.net, afecko@pcwa.net, Chanson@placer.ca.gov, bgray@natomaswater.com, Tjoseph@roseville.ca.us, tohalloran@ycfcwcd.org, ksicke@ycfcwcd.org, rcornwell@rivergardenfarms.com, dguy@norcalwater.org, arobin@norcalwater.org, tmanley@norcalwater.org, alexis@sacfarmbureau.org, staff@sacfarmbureau.org, rswartz@rwh2o.org, chanson@placer.ca.gov, sswd@hughes.net, rd1001@syix.com, info@enterpriserancheria.org, frontdesk@mooretown.org, rcuellar@ssband.org, tinagoodwin@washoetanf.org, bguth@auburnrancheria.com, aroberts@yochadehe-nsn.gov, ibojorquez@yochadehe-nsn.gov, lbill@yochadehe-nsn.gov, thpo@yochadehe-nsn.gov, pelgerwater@comcast.net, tobymoore@gswater.com, asteidleo@gmail.com, ashley@yubariver.org, ssilva@newcurrentwater.com, Bridget.Gibbons@wildlife.ca.gov, jimwallace@ecolusa.com, chad.l.oliver@gmail.com, lherbert@co.sutter.ca.us, ddolan@lgc.org, mdavis@americanrivers.org, jportiz@ucsusa.org, Xeronimo.Castaneda@audubon.org, sarthur@audubon.org, ellen.mcbride@noaa.gov, Margaret.Janes@water.ca.gov, amanda.cranford@noaa.gov, carlosgrebt@gmail.com, Maria.Jochimsen@water.ca.gov, Wjow@yubacity.net, jamarel@reasonfarms.com, stnanrsn@comcast.net, Chelsea.Spier@water.ca.gov, wooleyfarms@msn.com, DhootFamilyFarms@gmail.com, melinda@yubariver.org, Dave Runsten <dave@caff.org>, cruzmora5149@gmail.com, Andy Jansen <andy@sillerhelicopters.com>, wjow@yubacity.net, rfiroved@calrice.org, ewedemeyer@co.shasta.ca.us, amerill@americanrivers.org, jnguyen@woodardcurran.com, johnnguyenvincent@gmail.com, brian@sgtrees.com, gstadem@lundberg.com, reid@sgtrees.com, Maureen79@gmail.com, hcurrent@renewablegroup.com, dawnc@sutter.k12.ca.us, jstep1938@gmail.com, writingbyb@gmail.com, tncgroundwater@gmail.com, eugenio.castro@gmail.com, liz@northbutterealestate.com, matteolibros@matteolibros.com, lindamillerleads@gmail.com, mgause@westervelt.com, abbottbillwilliam@gmail.com, gwen.hartford@gmail.com, lambertj283@gmail.com, 67mikesmith@gmail.com, bking@pacgoldag.com, kanddboeger@gmail.com, ashlayhazalton36145@gmail.com, alsaeedcorporation963@gmail.com, ahmedkirillov5@gmail.com, shivers.bryant@gmail.com, nick@saaytext.com, olegivanover1@gmail.com, janlecompte7162@gmail.com, ShanCarney@gmail.com, davidmitchell7162@gmail.com, lshi@anatolygroup.com, qlouk@taikz.com, eric.jones.z.mail@gmail.com, peterson.betty@gmail.com, RudolphFriar@gmail.com, gafinan.c.ier@gmail.com, bowens.danae62@gmail.com, FerdinandPunter@hotmail.com, TennilleNesland@gmail.com, trena@sundatagroup.com, BlairLiberatore@gmail.com, olegivanover2@gmail.com, ClaudeGompf@gmail.com, jasonward9681@gmail.com, jesus.beltran@yahoo.com, no-replySterly@gmail.com, no-replyer@gmail.com, smorgan@yochadehe-nsn.gov, evie@businessleads101.com, KingBlackman@gmail.com, johanfourieltd@gmail.com



The Sutter Subbasin Groundwater Sustainability Plan Public Draft is Available for Review!

The nine Groundwater Sustainability Agencies (GSAs) of Sutter Groundwater Subbasin have been preparing a Groundwater Sustainability Plan (GSP) in response to the Sustainable Groundwater Management Act (SGMA). The Sutter Subbasin GSP will be complete by the end of 2021 and adopted prior to the regulatory deadline of January 31, 2022. The draft plan has been released in its entirety for public review.

- The **Sutter Subbasin GSP Public Draft** has been posted to the [Sutter Subbasin GSP website](http://www.SutterSubbasin.org) for public review and can be downloaded on the Resources page [here](#).
- The public **comment period is open until November 12, 2021**.
- Please email public comments to info@suttersubbasin.org and include "Sutter Subbasin GSP Public Draft comments" in the subject line.

Visit our website to learn more: www.SutterSubbasin.org. You can contact either me or Leslie Dumas of Woodard & Curran via email at the addresses included on this transmittal if you have any questions.

Additionally, we invite you **to Save the Date for our fifth public workshop on October 19, 2021** from 4:00 pm to 6:00 pm. This is presently scheduled to be a virtual workshop.

Thank You,

Guadalupe Rivera on behalf of Sutter Subbasin GSAs
Sutter County Development Services



Learn more at www.SutterSubbasin.org



¡El Borrador público del Plan de sostenibilidad del agua subterránea de la subcuenca de Sutter está disponible para revisión!

Las nueve Agencias de sostenibilidad del agua subterránea (Groundwater Sustainability Agencies, GSA) de la Subcuenca de agua subterránea de Sutter han estado preparando un Plan de sostenibilidad de agua subterránea (Groundwater Sustainability Plan, GSP) en respuesta a la Ley de gestión sostenible del agua subterránea (Sustainable Groundwater Management Act, SGMA). El GSP de la Subcuenca de Sutter se concluirá a fines de 2021, y se aprobará antes del plazo límite regulatorio del 31 de enero de 2022. El borrador del plan ha sido publicado para su revisión.

- El **Borrador público del Plan de sostenibilidad del agua subterránea de la subcuenca de Sutter** se ha publicado en el [sitio web del GSP de la subcuenca Sutter](#) para revisión pública y se pueden descargar en la página Recursos [aquí](#).
- El **periodo para comentario público está abierto hasta el 12 de noviembre de 2021**.
- Por favor envíe sus comentarios públicos por correo electrónico a info@suttersubbasin.org e incluya en el asunto del correo el texto "Sutter Subbasin GSP Public Draft Comments".

Visite nuestro sitio web para saber más: www.SutterSubbasin.org. Puede ponerse en contacto conmigo o con Leslie Dumas de Woodard & Curran por correo electrónico a las direcciones incluidas en este mensaje si tiene alguna pregunta.

Además, lo invitamos **a apuntar la fecha para nuestro quinto taller público que tendrá lugar el 19 de octubre de 2021**, de 4:00 pm a 6:00 pm. Por ahora está previsto que este sea un taller virtual.

Gracias,

Guadalupe Rivera, en nombre de las GSA de la Subcuenca de Sutter
Servicios de desarrollo del Condado de Sutter



Puede encontrar más información en www.SutterSubbasin.org



ਜਨਤਕ ਸਮੀਖਿਆ ਅਤੇ ਟਿੱਪਣੀ ਲਈ ਡ੍ਰਾਫਟ ਗ੍ਰਾਊਂਡਵਾਟਰ ਸਸਟੇਨੇਬਲਿਟੀ ਪਲਾਨ ਉਪਲਬਧ ਹੈ!

ਸਟਰ ਗ੍ਰਾਊਂਡਵਾਟਰ ਸਬਬੇਸਿਨ ਦੀਆਂ ਨੌਂ ਗ੍ਰਾਊਂਡਵਾਟਰ ਸਸਟੇਨੇਬਲਿਟੀ ਏਜੰਸੀਆਂ (GSAs) ਸਸਟੇਨੇਬਲ ਗ੍ਰਾਊਂਡਵਾਟਰ ਮੈਨੇਜਮੈਂਟ ਐਕਟ (SGMA) ਦੀ ਪ੍ਰਤੀਕਿਰਿਆ ਵਿੱਚ ਗ੍ਰਾਊਂਡਵਾਟਰ ਸਸਟੇਨੇਬਲਿਟੀ ਪਲਾਨ (GSP) ਤਿਆਰ ਕਰ ਰਹੀਆਂ ਹਨ। ਸਟਰ ਸਬਬੇਸਿਨ GSP 2021 ਦੀ ਸਮਾਪਤੀ ਤੱਕ ਪੂਰੀ ਹੋਵੇਗੀ ਅਤੇ 31 ਜਨਵਰੀ, 2022 ਦੀ ਰੈਗੂਲੇਟਰੀ ਸਮਾਂ-ਸੀਮਾ ਤੋਂ ਪਹਿਲਾਂ ਗ੍ਰਹਿਣ ਕੀਤਾ ਜਾਵੇਗਾ। ਸਟਰ ਸਬਬੇਸਿਨ ਗ੍ਰਾਊਂਡਵਾਟਰ ਸਸਟੇਨੇਬਲਿਟੀ ਪਲਾਨ ਪਬਲਿਕ ਡ੍ਰਾਫਟ ਨੂੰ ਜਨਤਕ ਟਿੱਪਣੀ ਕਾਲ ਲਈ 1 ਅਕਤੂਬਰ ਤੋਂ 12 ਨਵੰਬਰ ਤੱਕ ਉਪਲਬਧ ਕਰਵਾਏ ਜਾਣ ਦੀ ਉਮੀਦ ਹੈ।

- ਨੂੰ ਜਨਤਕ ਸਮੀਖਿਆ ਲਈ ਸਟਰ ਸਬਬੇਸਿਨ GSP ਵੈਬਸਾਈਟ 'ਤੇ ਪੋਸਟ ਕੀਤਾ ਗਿਆ ਹੈ ਅਤੇ ਇਸਨੂੰ ਇੱਥੇ ਰਿਸ਼ੱਰਸ ਪੇਜ 'ਤੇ ਡਾਊਨਲੋਡ ਕੀਤਾ ਜਾ ਸਕਦਾ ਹੈ।
- ਪਬਲਿਕ ਕੁਮੈਂਟ ਅਵਧੀ 12 ਨਵੰਬਰ, 2021 ਤੱਕ ਖੁੱਲ੍ਹਾ ਹੈ।
- ਕਿਰਪਾ ਕਰਕੇ info@suttersubbasin.org 'ਤੇ ਜਨਤਕ ਟਿੱਪਣੀਆਂ ਈਮੇਲ ਕਰੋ ਅਤੇ ਵਿਸ਼ਾ ਲਾਇਨ ਵਿੱਚ "ਸਟਰ ਸਬਬੇਸਿਨ GSP ਕੁਮੈਂਟਸ" ਸ਼ਾਮਲ ਕਰੋ।

ਜ਼ਿਆਦਾ ਜਾਣਕਾਰੀ ਲਈ ਸ਼੍ਰੀ ਵੈਬਸਾਈਟ 'ਤੇ ਜਾਓ: www.SutterSubbasin.org ਜੇ ਤੁਹਾਡਾ ਕੋਈ ਸਵਾਲ ਹੈ ਤੁਸੀਂ ਇਸ ਪ੍ਰਸਾਰਣ 'ਤੇ ਸ਼ਾਮਲ ਪਤੇ 'ਤੇ ਈਮੇਲ ਰਾਹੀਂ ਮੈਨੂੰ ਜਾਂ ਵੁਡਾਰਡ ਐਂਡ ਕੁਰੇਨ ਦੇ ਲੇਸਿਲ ਦਮਸ ਨਾਲ ਸੰਪਰਕ ਕਰ ਸਕਦੇ ਹੋ।

ਇਸ ਤੋਂ ਇਲਾਵਾ, ਅਸੀਂ ਸ਼ਾਮ 4:00 ਵਜੇ ਤੋਂ 6:00 ਵਜੇ ਤੱਕ 19 ਅਕਤੂਬਰ, 2021 ਨੂੰ ਸਾਡੀ #5 ਪਬਲਿਕ ਵਰਕਸ਼ਾਪ ਲਈ ਤਾਰੀਖ ਸੇਵ ਕਰਨ ਲਈ ਸਦਾ ਦਿੰਦੇ ਹਾਂ। ਇਹ ਮੌਜੂਦਾ ਸਮੇਂ ਵਿੱਚ ਇੱਕ ਵਰਚੂਅਲ ਵਰਕਸ਼ਾਪ ਨਿਰਧਾਰਿਤ ਕੀਤੀ ਜਾਵੇਗੀ।

ਧੰਨਵਾਦ,

ਸਟਰ ਸਬਬੇਸਿਨ GSAs ਵੱਲੋਂ ਗੁਆਡਾਲੋਪ ਰਿਵੇਰਾ
ਸਟਰ ਕਾਉਂਟੀ ਡਵੈਲਪਮੈਂਟ ਸੇਵਾਵਾਂ



www.SutterSubbasin.org 'ਤੇ ਜ਼ਿਆਦਾ ਜਾਣਕਾਰੀ ਲਓ



Sutter Subbasin <info@suttersubbasin.org>

NOTICE (Aviso/नोटिस): The Sutter Subbasin Groundwater Sustainability Plan Public Draft is Available for Review!

Sutter Subbasin <info@suttersubbasin.org>

Mon, Nov 1, 2021 at 11:42 AM

To: Guadalupe Rivera <grivera@co.sutter.ca.us>, Leslie Dumas <ldumas@woodardcurran.com>, Natalie Cochran <ncochran@woodardcurran.com>, vdeanda@woodardcurran.com

Bcc: morme@buttewater.net, scrolls@rarcivil.com, lphillips@sutterewd.com, sutterwater@aol.com, kwillis@yubacity.net, aduffey@succeed.net, brad@sutterbasinwater.com, jon@montnafarms.com, jtdfwd@yahoo.com, dd49erdd@yahoo.com, Pschubert@gswater.com, dguy@norcalwater.org, arobin@norcalwater.org, tmanley@norcalwater.org, alexis@sacfarmbureau.org, staff@sacfarmbureau.org, rswartz@rwah2o.org, chanson@placer.ca.gov, sswd@hughes.net, rd1001@syix.com, info@enterpriserancheria.org, frontdesk@mooretown.org, rcuellar@ssband.org, tinagoodwin@washoetanf.org, bguth@auburnrancheria.com, aroberts@yochadehe-nsn.gov, ibojoquez@yochadehe-nsn.gov, lbill@yochadehe-nsn.gov, thpo@yochadehe-nsn.gov, pelgerwater@comcast.net, tobymoore@gswater.com, asteidleo@gmail.com, ashley@yubariver.org, justine@ysfarmbureau.com, ssilva@newcurrentwater.com, Bridget.Gibbons@wildlife.ca.gov, jimwallace@ecolusa.com, chad.l.oliver@gmail.com, lherbert@co.sutter.ca.us, ddolan@lgc.org, mdavis@americanrivers.org, jportiz@ucsusa.org, Xeronimo.Castaneda@audubon.org, sarthur@audubon.org, ellen.mcbride@noaa.gov, Margaret.Janes@water.ca.gov, amanda.cranford@noaa.gov, carlosgrebt@gmail.com, Maria.Jochimsen@water.ca.gov, Wjow@yubacity.net, jamarel@reasonfarms.com, stnansrn@comcast.net, Chelsea.Spier@water.ca.gov, wooleyfarms@msn.com, DhootFamilyFarms@gmail.com, melinda@yubariver.org, Dave Runsten <dave@caff.org>, cruzmora5149@gmail.com, Andy Jansen <andy@sillerhelicopters.com>, wjow@yubacity.net, rfiroved@calrice.org, ewedemeyer@co.shasta.ca.us, amerill@americanrivers.org, jnguyen@woodardcurran.com, johnnguyenvincent@gmail.com, brian@sgtrees.com, gstadem@lundberg.com, reid@sgtrees.com, Maureen79@gmail.com, hcurrent@renewablegroup.com, dawnc@sutter.k12.ca.us, jstep1938@gmail.com, writingbyb@gmail.com, tncgroundwater@gmail.com, eugenio.castro@gmail.com, liz@northbutterealestate.com, matteolibros@matteolibros.com, lindamillerleads@gmail.com, mgause@westervelt.com, abottbillwilliam@gmail.com, gwen.hartford@gmail.com, lambertj283@gmail.com, 67mikesmith@gmail.com, bking@pacgoldag.com, kanddboeger@gmail.com, ashlayhazalton36145@gmail.com, alsaeedcorporation963@gmail.com, ahmedkirillov5@gmail.com, shivers.bryant@gmail.com, nick@saaytext.com, cbuck@buttecounty.net, olegivanover1@gmail.com, janlecompte7162@gmail.com, ShanCarney@gmail.com, davidmitchell7162@gmail.com, lshi@anatolygroup.com, qlouk@taikz.com, eric.jones.z.mail@gmail.com, peterson.betty@gmail.com, RudolphFriar@gmail.com, gafinan.c.ier@gmail.com, bowens.danae62@gmail.com, FerdinandPunter@hotmail.com, TennilleNesland@gmail.com, trena@sundatagroup.com, BlairLiberatore@gmail.com, olegivanover2@gmail.com, ClaudeGompf@gmail.com, jasonward9681@gmail.com, jesus.beltran@yahoo.com, no-replySterly@gmail.com, no-replyer@gmail.com, smorgan@yochadehe-nsn.gov, evie@businessleads101.com, KingBlackman@gmail.com, johanfourieltd@gmail.com, AngeloJude@gmail.com, cole.mena@yahoo.com, ida@order-fulfillment.net, olegivanover3@gmail.com, alio.shivams@halumail.com, malinoleg91@mail.ru, bermingham.zelda@gmail.com, MaidaBurgener@hotmail.com, denisandreev1989521a1n+I7@list.ru, maks.gusarskiy.86@mail.ru, ivakhov1988@mail.ru, toby_knows@yahoo.com, svetlana.krasnodymova@mail.ru, olegivanover4@gmail.com, merabi_almerabi@carleton.ca, mvexbe05@hotmail.com, jerry.cutler@gmail.com, rollszerviz@gmail.com, olegivanover5@yahoo.com, medvedeva.pavlina2001@mail.ru, burg.laurinda27@msn.com, burton@order-fulfillment.net, dan.navarro@free.fr, garey.shavonne@gmail.com, steve@explainervideos4u.xyz, olegivanover6@yahoo.com, sfsdsdvdsdv@yahoo.com



Reminder: The Sutter Subbasin Groundwater Sustainability Plan Public Draft is Available for Review!

Comments on the Sutter Subbasin GSP Public Draft are due **November 12, 2021** to info@suttersubbasin.org. The Public Draft can be downloaded on the Resources page [here](#). See original email below for

more information.

Additionally, a recording of our fifth public workshop from October 19, 2021 can be accessed on the Meetings page [here](#) with closed captions in English, Spanish, and Punjabi.

Thank You,

Guadalupe Rivera on behalf of Sutter Subbasin GSAs
Sutter County Development Services



Learn more at www.SutterSubbasin.org

[Quoted text hidden]



SUSTAINABLE GROUNDWATER MANAGEMENT ACT

Managing Our Water Resources for the Future

What is SGMA?

The **Sustainable Groundwater Management Act**, known as “SGMA” (pronounced sig-ma), is a California State law that was passed in 2014. SGMA’s goal is to ensure the long-term sustainable management of the State’s groundwater resources. SGMA requires agencies throughout California to meet certain requirements. These include:

- ◆ **Forming Groundwater Sustainability Agencies**
- ◆ **Developing Groundwater Sustainability Plans**
- ◆ **Achieving balanced groundwater levels within 20 years**

How Does This Impact Me?

Water is vital to the economy, the environment, and the quality of life in Sutter County. While this precious resource is visible every day in the Sacramento and Feather Rivers, water underground is no less important, providing about half of the region’s water supply. Groundwater serves the needs of cities, farms and businesses and provides high quality drinking water to urban and rural residents, all while helping to sustain vital ecosystems.

What is the Sutter Subbasin?

The Sutter Subbasin is generally described as being in the “central portion of the Sacramento Valley Groundwater Basin.” It is located within Sutter County and is bounded on the north by Butte-Sutter County line (except for the Sutter County portion of Biggs-West Gridley Water District), on the west by the Sacramento River, on the south by the confluence of the Sacramento River and the Feather River, and on the east by the Feather River and the eastern boundary with the Sutter-Yuba County line.

Who are the Sutter Subbasin GSAs

Groundwater Sustainability Agencies (GSAs) were formed in accordance with SGMA. The GSAs in the Subbasin are working together to meet SGMA requirements and collaboratively prepare a groundwater sustainability plan (GSP). This plan will outline how the agencies will implement, manage, and measure specific actions to sustainably manage the groundwater. The GSP for the Sutter Subbasin must be submitted to the State no later than January 31, 2022.

The Sutter Subbasin Groundwater Sustainability Agencies include:





- ◆ **Sutter County**
- ◆ **Butte Water District**
- ◆ **City of Live Oak**
- ◆ **Sutter Extension Water District**
- ◆ **Sutter Community Services District**
- ◆ **City of Yuba City**
- ◆ **Reclamation District 70**
- ◆ **Reclamation District 1500**
- ◆ **Reclamation District 1660**

Why You Should Be Involved

Join us and learn about the condition and future health of your groundwater subbasin. Participate in the process to understand what needs to be done to protect the quality and availability of this valuable resource. Learn why maintaining a sustainable groundwater subbasin matters to the economy, environment, and quality of life of our urban and rural communities.



Your Community. Your Water. Get Involved.

-  Sign up for our stakeholder list
-  Talk to your local GSA representative
-  Attend public meetings and workshops
-  Provide input on the groundwater sustainability plan
-  Help us spread the word!

GET INVOLVED! To sign up for our stakeholder list or learn more information visit our website.

SutterSubbasin.org

Sutter Subbasin GSP — Public Workshops

See our website for information on how to join our upcoming committee meetings and public workshops!

<http://www.suttersubbasin.org/meetings.html>

All meetings will be held virtually due to COVID-19 until further notice.

Please email info@suttersubbasin.org if you have any questions.

California's Sustainable Groundwater Management Act (SGMA): Understanding the Law

The California Farm Bureau Federation developed this resource for farmers and landowners to help you understand why SGMA is important and how you can be involved.

SGMA requires formation of local agencies to develop new plans, called Groundwater Sustainability Plans or GSPs, to address and prevent problems in groundwater basins in most areas of the state. Signed into law in September 2014, SGMA focuses on protecting California's groundwater for generations to come.



How can I get involved?
 How will it affect me?
 Why do we have SGMA?
 Where does it apply?

The Road to Sustainability

Learn and Engage!

Participate now to represent your interest. SGMA stresses local group formation, local plans and local management.

SGMA plans will reflect local conditions and can include local solutions. Once approved by the state, your local plan represents a commitment to future actions.

Let's be clear:

- SGMA will affect your groundwater pumping
- SGMA establishes new responsibilities to share groundwater
- SGMA will change how we use land and water
- SGMA does not change water rights

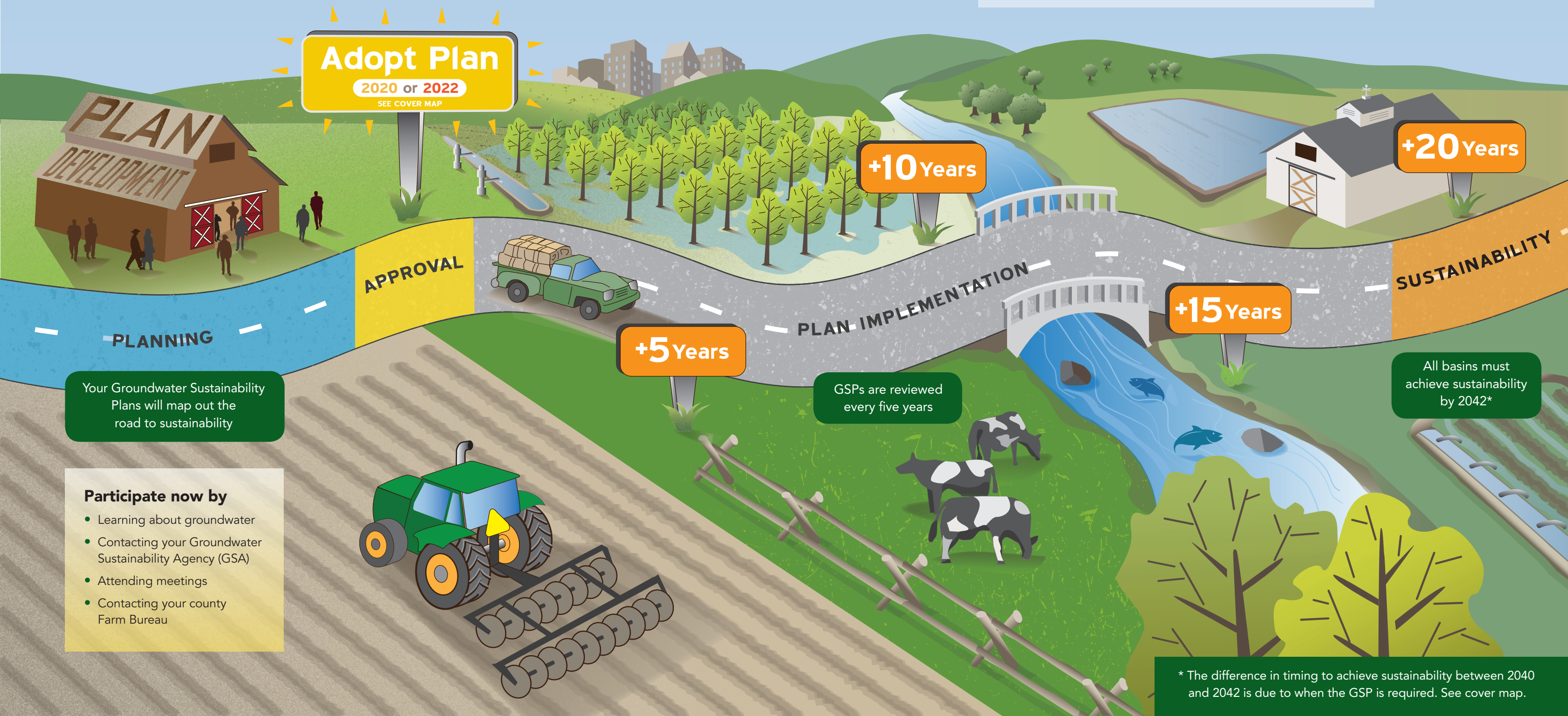

Adopt Plan
2020 or 2022
SEE COVER MAP

PLAN DEVELOPMENT

APPROVAL

+10 Years

+20 Years

PLANNING

Your Groundwater Sustainability Plans will map out the road to sustainability

+5 Years

PLAN IMPLEMENTATION

GSPs are reviewed every five years

+15 Years

SUSTAINABILITY

All basins must achieve sustainability by 2042*

- Participate now by**
- Learning about groundwater
 - Contacting your Groundwater Sustainability Agency (GSA)
 - Attending meetings
 - Contacting your county Farm Bureau

* The difference in timing to achieve sustainability between 2040 and 2042 is due to when the GSP is required. See cover map.

Opportunities and Challenges on the Road to Sustainability

GSP development and implementation will be a balancing act — among different interests, between water supply and water demand, and among beneficial uses. This is your opportunity to be involved, to ensure your interests are considered.

The primary tools your Groundwater Sustainability Agencies (GSA) have in the development of your GSP will be measures to either manage demand or manage supply.

Some tools to balance groundwater supply and demand

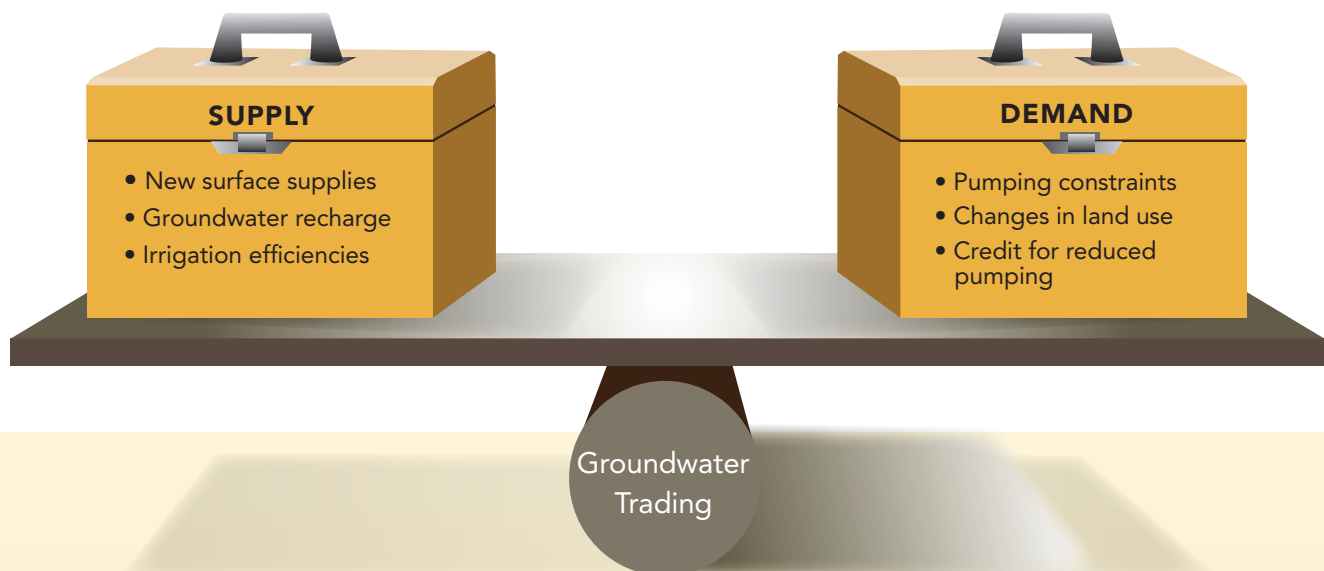

Groundwater Sustainability Plans (GSPs) will:

- Describe the basin
- Develop a water budget
- Set groundwater management standards and objectives
- Identify actions and projects to meet those standards and objectives
- Establish a monitoring program to measure success

GSPs will be geared to improvements over 20 years; plans will be reviewed every five years.

Groundwater Sustainability Agency (GSA) authorities:

- Regulate pumping
- Require measurement and reporting of groundwater use
- Charge fees
- Enforce the GSP

GSAs will have the power to manage both supply and demand to meet objectives developed in the GSP.

Why SGMA?

California groundwater is an essential resource — we need it for farms, cities and other uses, today and tomorrow. SGMA seeks to ensure reliable groundwater supplies in the future through long-term groundwater management across California. The law creates a statewide process intended to protect future groundwater availability.

SGMA focuses on managing these six undesirable results

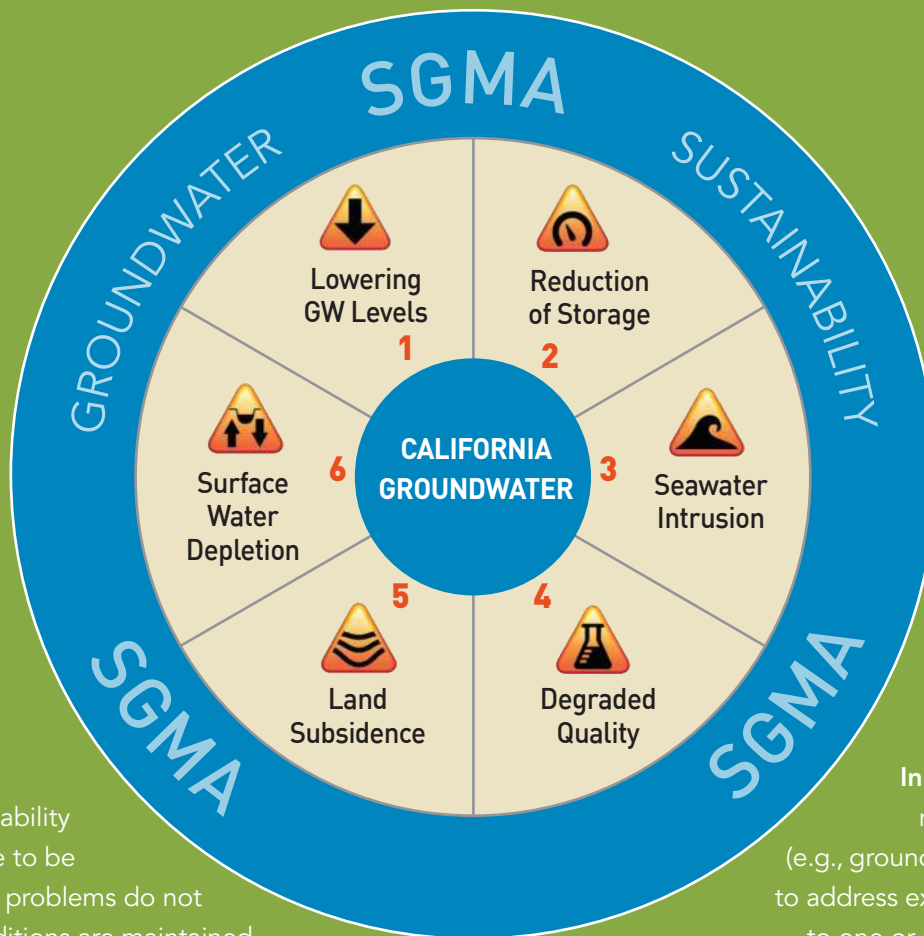

In some regions, Groundwater Sustainability Plans (GSPs) will have to be developed to ensure problems do not occur and good conditions are maintained over the next 20 years.

In other regions, GSPs will require significant actions (e.g., groundwater recharge projects) to address existing challenges related to one or more of the “undesirable results,” shown above.

SGMA encourages local communities to work together to develop effective GSPs, and encourages neighboring basins to find common, acceptable solutions. Basins not managed locally will have plans written and implemented by the State Water Resources Control Board.

Terms to know

- **Adjudicated Areas:** Where disputes over legal rights to groundwater have resulted in a court-issued ruling (known as an adjudication). Adjudications can cover an entire basin, a portion of a basin, or a group of basins.
- **Basin Prioritization:** Classification of California's 517 groundwater basins and subbasins into priorities based primarily on the importance of groundwater to the area. The priority of basins and subbasins determines the schedule for completing GSPs and whether SGMA provisions apply in a given basin. High- and medium-priority basins must comply with SGMA.
- **Best Management Practices (BMPs):** Practices designed to help achieve sustainable groundwater management. BMPs are intended to be effective, practical, and based on best available science.
- **Bulletin 118:** A California Department of Water Resources (DWR) document outlining the locations and characteristics of groundwater basins in California.
- **Critically Overdrafted:** Basins and subbasins identified by DWR to be subject to conditions of critical overdraft. GSPs are due in 2020.
- **Groundwater Sustainability Agency (GSA):** One or more local agencies that implement the provisions of SGMA.
- **Groundwater Sustainability Plan (GSP):** A local plan proposed by a GSA and approved by the state.
- **Measurable Objectives:** Conditions linked to the sustainability goals of the GSP, to be achieved in the basin within 20 years.
- **Sustainability Goals:** Metrics established in the GSP planning process to ensure that a basin is operated within its sustainable yield.
- **Sustainable Yield:** The amount of water that can be extracted from a basin without causing problems to the groundwater basin. See undesirable results on "Why SGMA?" page.
- **Undesirable Results:** The problems that SGMA strives to solve or prevent. See undesirable results on "Why SGMA?" page.
- **Water Budget:** An estimated accounting of all the water (surface and groundwater) that flows into and out of a basin.

To learn more

Department of Water Resources
SGMA portal at:
sgma.water.ca.gov/portal

Groundwater Exchange
groundwaterexchange.org

California Farm
Bureau Federation
www.cfbf.com

How your involvement can help improve our collective understanding of local groundwater hydrology.

SGMA encourages a bottoms-up, stakeholder driven planning process, relying on the reporting from farmers, landowners and other stakeholders. The information collected at the local level adds up to make a big difference.

Good Local Information

The SGMA planning process relies on good local data to understand the groundwater basin and hydrology. Data on groundwater levels, stream flows, and irrigation patterns can all contribute to a better conceptual model of your basin and will help ensure effective management and continued availability of groundwater over time.



Good SGMA Modeling Tools

Modeling tools are an essential component of the SGMA process. These tools will rely on local data. It is important that local stakeholders assist in the development of these tools so that the output can be trusted. The tools can be used to inform the effectiveness of various management options and ensure the legal and technical adequacy of a local plan.



A Foundation For a Good GSP

A solid foundation of local information and output from modeling tools leads to well-informed decisions regarding management strategies, sustainable criteria and other important Groundwater Sustainability Plan (GSP) outcomes.

The California Farm Bureau developed this resource to assist farmers and landowners in understanding the concepts and terminology of groundwater hydrology that are important to the Sustainable Groundwater Management Act.

This brochure is a companion to the Farm Bureau's earlier publication titled: *California's Sustainable Groundwater Management Act (SGMA): Understanding the Law*. We suggest using these documents in tandem to provide an overview of the legal and technical underpinnings of SGMA.

Local information is needed to develop effective sustainability plans.

The balancing act required to develop effective Groundwater Sustainability Plans relies on the participation of farmers, landowners and other stakeholders to provide reliable and accurate local information. Shared understanding of the characteristics and functioning of your local groundwater basin is vital. **This is only achievable through your involvement.**

What types of local data are most important to the SGMA process?

- Groundwater elevations
- Farming practices
- Well logs
- Local stream flow conditions

This data will be used to create modeling output which will inform your Groundwater Sustainability Agency with historic, current and projected conditions. Local farmer and landowner involvement in ground truthing the validity of these modeling outputs is very helpful.

To learn more

Department of Water Resources
SGMA portal at:
sgma.water.ca.gov/portal

Groundwater Exchange
groundwaterexchange.org

California Farm
Bureau Federation
www.cfbf.com



California's Sustainable Groundwater Management Act (SGMA):

Groundwater Hydrology

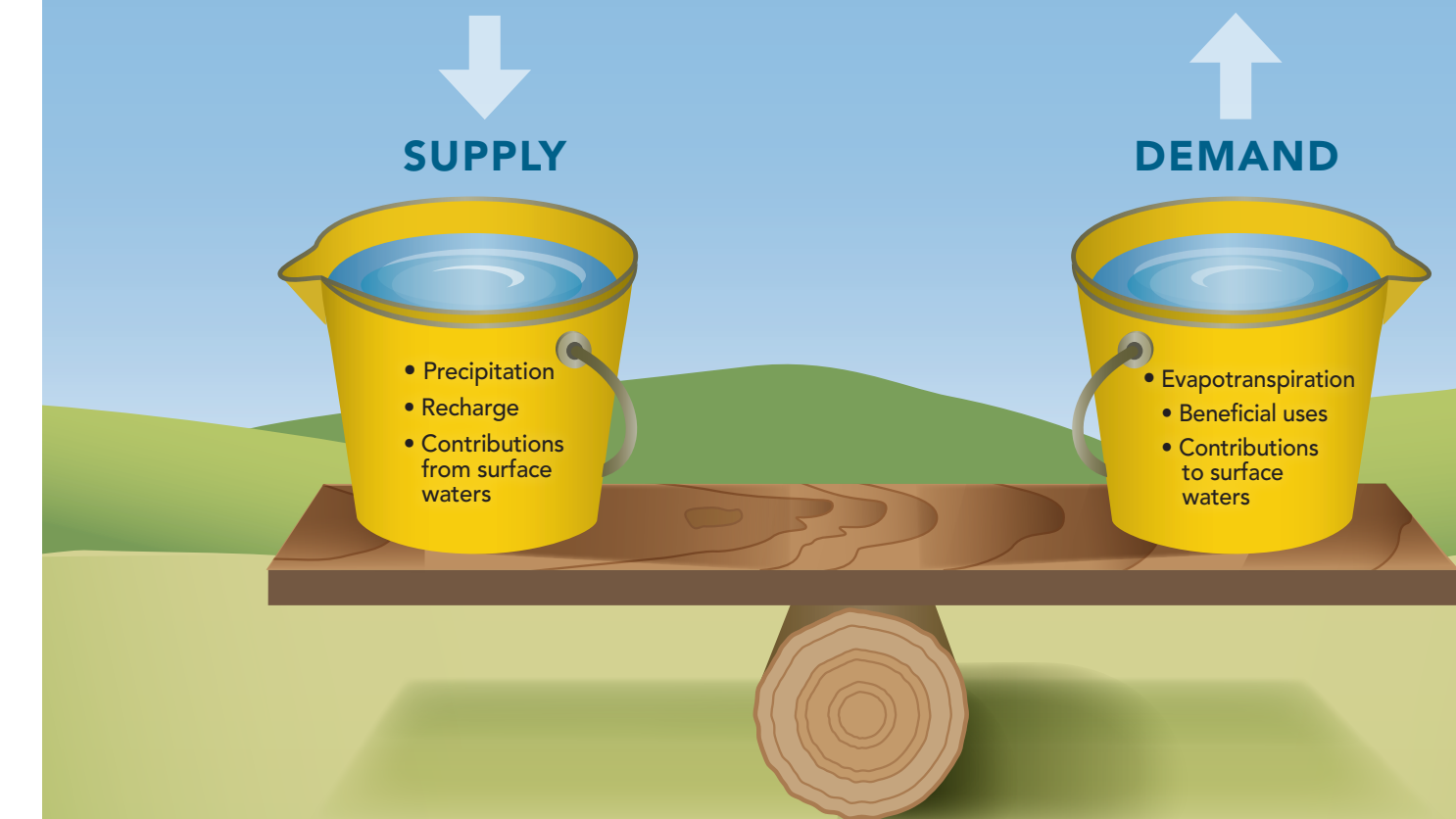

Groundwater supply and demand is a balancing act.

At the core of SGMA is the need to manage supply and demand, creating groundwater conditions that are sustainable over the long term, protecting beneficial users.

How does this impact my farm and community?

How does understanding my local groundwater hydrology contribute?

What type of local information is important?

Water Budget

An accounting of all the water that flows into and out of a project area.

Groundwater basins operate like a bank account. Landowners and water users in a basin all draw from the same "account." The goal is to balance the debits and credits, not draw down the principal. In some basins, we have depleted our groundwater "principal" by pumping more than what has been replenished.

How do we deposit water into the groundwater "account"?

Groundwater is naturally replenished through:

- Precipitation
- Infiltration from irrigation
- Infiltration from surface water systems (rivers, lakes, channels ...)
- Groundwater inflow (as lateral inflow from neighboring subbasins)

Groundwater can also be artificially replenished through the diversion or import of surface water supplies and through aquifer recharge and replenishment projects (Managed Aquifer Recharge (MAR), Aquifer Storage and Recovery (ASR)).

1 Water table: The upper surface of the saturated zone; i.e. all soil pores are filled by water.

2 Groundwater: Water available in the saturated zone below the water table is called groundwater.

3 Aquifer: An aquifer is a body of saturated rock or sediment underneath the water table, where groundwater exists. Aquifers are permeable and porous.

4 Infiltration: The process of water on the ground surface entering the soil.

5 Vadose zone: The underlying, unsaturated earth material extending downward from the soil surface to where the soil becomes saturated; i.e. all soil pores are filled by water.

6 Recharge/replenishment: The process of water moving downward through the soil or fractured rock. It can happen naturally to an aquifer, or artificially.

7 Gaining/losing streams: When a stream reach is gaining, the groundwater moves from the ground into the channel. When a stream reach is losing, water moves from the channel into the aquifer.

8 Saltwater intrusion: Movement of saline water into freshwater aquifers, which can lead to contamination of drinking water sources and other consequences.

9 Subsidence: Lowering of the land-surface elevation due to changes that take place underground, such as lowering of groundwater levels.

10 Evapotranspiration: The sum of evaporation from the land surface plus transpiration from plants. Put simply, evaporation occurs when water vapor leaves the soil or a plant's surface. Transpiration involves the passage of water through a plant, from its roots through its vascular system.

11 Precipitation: Rain, snow, sleet or hail that falls to the ground.

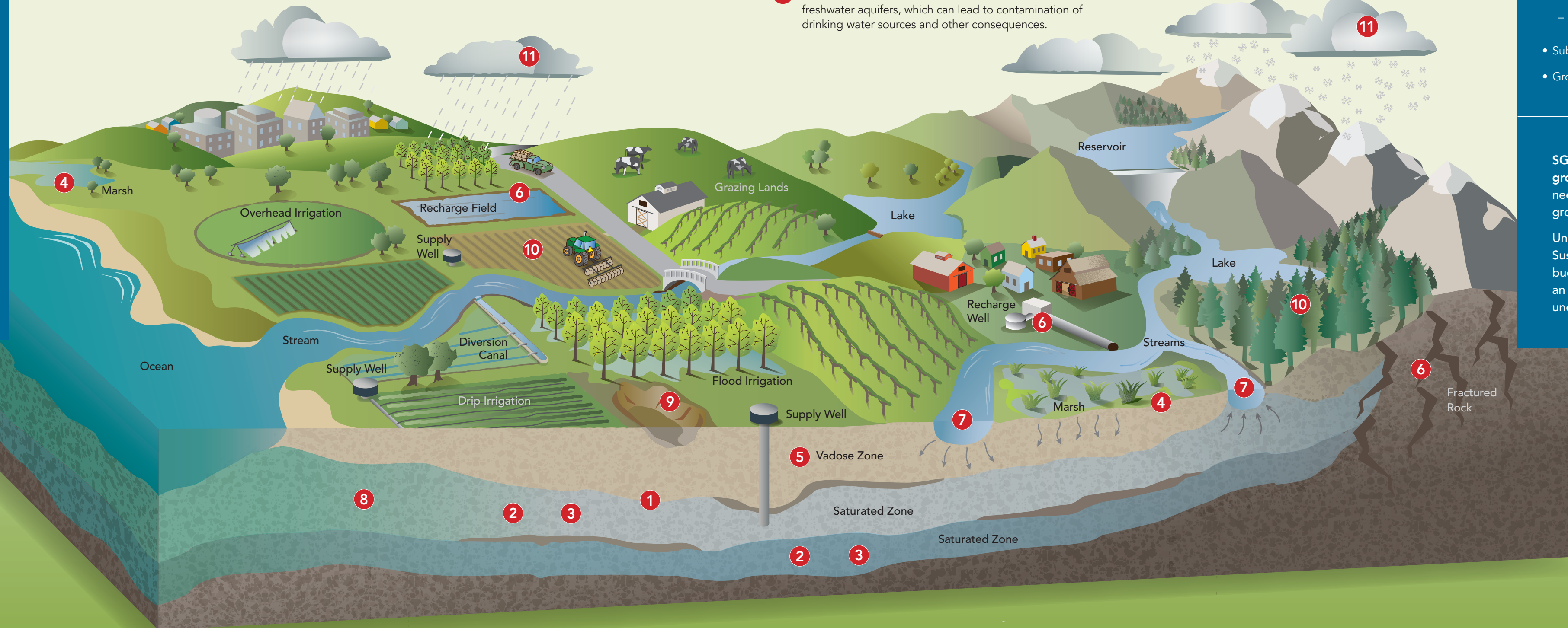

Withdrawals from the groundwater "account" happen in various ways:

- Groundwater use/extractions:
 - Irrigation
 - Public supply for drinking water in cities and towns
 - Industrial uses
 - Domestic and livestock purposes
 - Natural ecosystems
- Subsurface groundwater outflows
- Groundwater discharge to surface water systems

SGMA will lead to new actions to manage groundwater: To be involved with SGMA, you need to understand the terminology of how groundwater works and how it is sustained.

Under SGMA, local Groundwater Sustainability Agencies (GSAs) use the water budget to define "sustainable yield" — an amount that is locally defined and avoids undesirable results.

Lowering Groundwater Levels

Multiple factors affect groundwater levels.

Groundwater levels in aquifers vary over time, increasing when replenished by infiltration and recharge from surface water, precipitation and irrigation, and decreasing when groundwater discharges to surface water or when groundwater pumping occurs. Chronic lowering of groundwater levels can occur when the volume of groundwater pumped exceeds the volume of recharge, year over year. SGMA requires that Groundwater Sustainability Plans (GSPs) set forth actions to stabilize and/or improve groundwater levels.

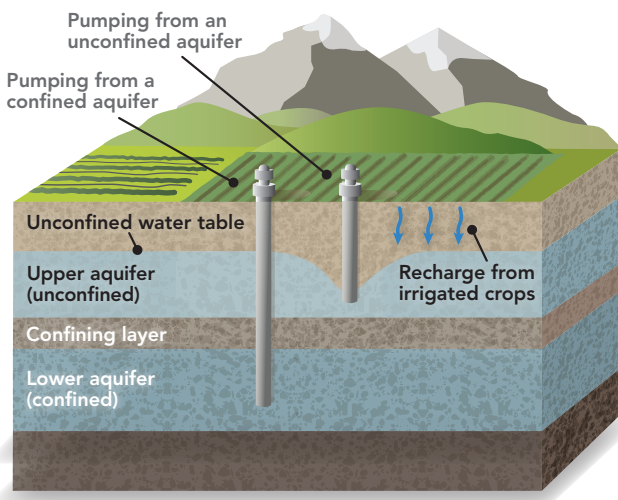

Groundwater responds differently to pumping based on geology and climate factors.

Geology controls how groundwater levels vary naturally and how they will respond to groundwater pumping. Local geology results in two kinds of aquifers: unconfined aquifers and confined aquifers. Unconfined aquifers often extend from the land surface and receive recharge directly from the overlying land surface. Confined aquifers have impermeable rock or clay layers that limit recharge from directly above the aquifer.

Why can groundwater levels decrease?

Groundwater levels in confined and unconfined aquifers typically vary seasonally. Over longer periods, groundwater levels can vary in response to multi-year wet or dry conditions. This natural variability can be exacerbated by over-reliance on groundwater when surface water supplies are limited, unavailable, or highly variable, year-to-year. Some areas of California have seen groundwater declines for decades as a result of groundwater pumping.

Aquifers in areas with higher rainfall can receive substantial natural recharge during winter months that may offset groundwater pumping impacts, while aquifers in arid areas that receive little natural recharge are more susceptible to over-pumping.

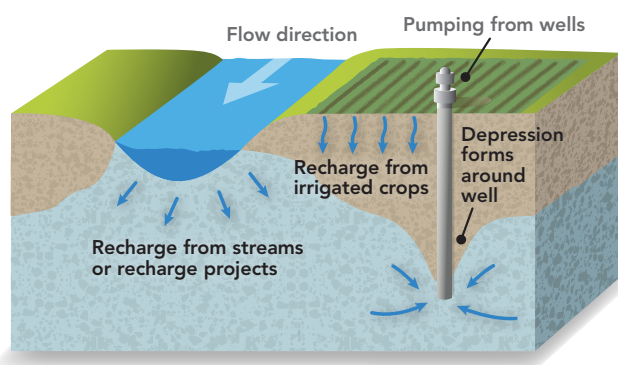

Why do groundwater levels matter?

How does groundwater pumping affect groundwater levels?

How might this impact future groundwater pumping?

Will chronic lowering of groundwater levels affect me and my community?

In addition to decreasing the reliability of groundwater as a water supply at the basin scale, the chronic lowering of groundwater levels requires more energy to pump water. In some basins with specific types of geology, lowering groundwater levels can be associated with subsidence, which may permanently reduce the storage capacity of the aquifer system.

Lowering groundwater levels may require costly expenditures, like lowering a pump within a well casing, deepening an existing well, or even drilling a new well.

How can we monitor groundwater levels to demonstrate the success of our Groundwater Sustainability Plan?

The GSP may require modified operations of wells to minimize chronic lowering of groundwater levels. The GSP will establish a monitoring network to assess the success of such modifications by measuring groundwater levels at key locations within your groundwater basin.

SUSTAINABLE VERSUS UNSUSTAINABLE MANAGEMENT

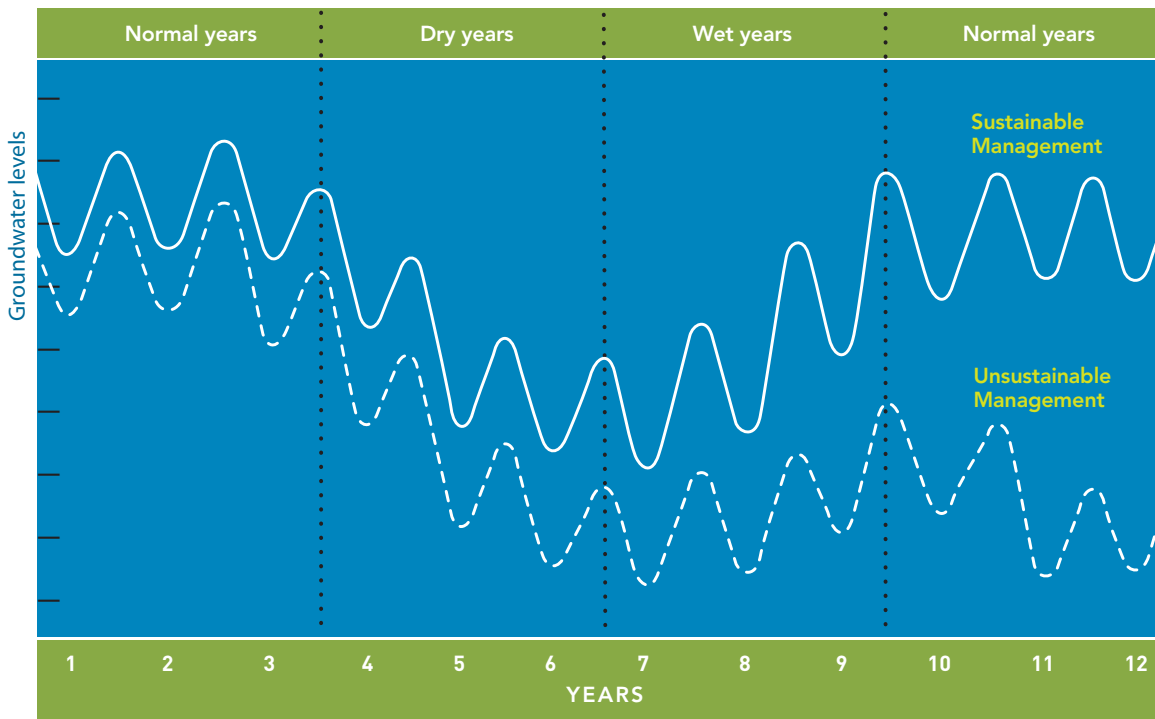

In California's highly variable climate, groundwater levels will fluctuate naturally.

In sustainably managed basins, groundwater levels will have more opportunity to recover over time.

What might I be asked to do?

- Coordinate with my neighbors in development of a GSP through participation in my Groundwater Sustainability Agency (GSA)
- Adjust or reduce total pumping volumes
- Participate in or contribute to groundwater recharge programs or projects

Be involved in your local GSA

SGMA encourages local landowners to work together to develop effective GSPs, and encourages neighboring basins to find common, acceptable solutions. Basins not managed locally, that fail to take corrective action over time, may have plans written and implemented by the State Water Resources Control Board.

Reduction of Storage

Factors that affect groundwater storage.

Groundwater storage in an aquifer varies over time, increasing when replenished by infiltration and recharge from surface water, precipitation, and irrigation, and decreasing when groundwater discharges to surface water or when groundwater pumping occurs. Reductions in groundwater storage are reflected in falling groundwater levels and can occur when the volume of groundwater pumped exceeds the volume replenished, year over year. SGMA requires that Groundwater Sustainability Plans (GSPs) address significant and unreasonable reductions of groundwater storage.

Groundwater Storage Fluctuations

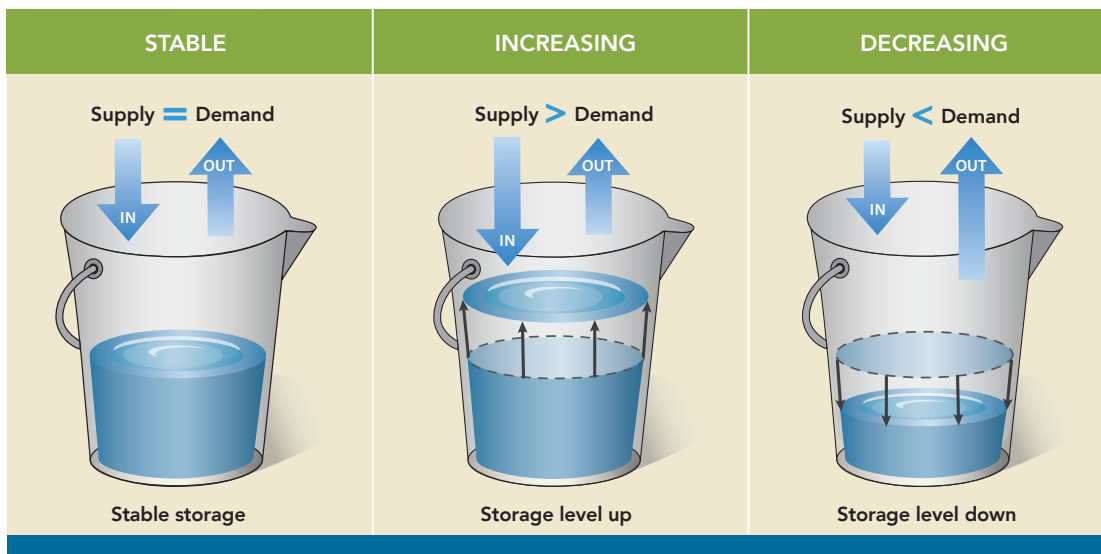

Supply (inflow):

- Precipitation
- Recharge
- Contributions from surface water

Demand (outflow):

- Evapotranspiration
- Beneficial users
- Contributions to surface water

Why can groundwater storage decrease?

Like a bank account, the amount of available groundwater storage volume in a basin is supplemented by groundwater inflows from precipitation, recharge, and contributions from surface water (deposits) and is depleted by pumping by beneficial users and discharge to surface water (withdrawals). When groundwater withdrawals exceed inflows and recharge, groundwater storage (the account balance) is

reduced. Like a household budget, a groundwater budget can be developed to evaluate groundwater inflows and outflows to guide management decisions. Measurements of groundwater levels, precipitation, streamflow, and evapotranspiration can be used in conjunction with computer groundwater models to develop a groundwater budget and help guide the development of the GSP.

Why does groundwater storage matter?

How does groundwater pumping affect groundwater storage?

How might this impact future groundwater pumping?

How do decreases in groundwater storage affect me and my community?

Long term declines in groundwater storage volumes reduce the reliability of groundwater as a water supply for agricultural, municipal, domestic and industrial uses. In some basins with specific types of geology, declines in groundwater storage can be associated with subsidence, which may permanently reduce the storage capacity of the aquifer system.

How can we monitor groundwater storage to demonstrate the success of our plan?

Groundwater levels in various wells throughout a basin can be used in conjunction with computer models to estimate the overall groundwater storage in local aquifers. Since water levels can vary throughout an aquifer, it is important to monitor groundwater levels at multiple locations. The GSP will establish a monitoring network to assess the success of planned actions to stabilize groundwater storage.

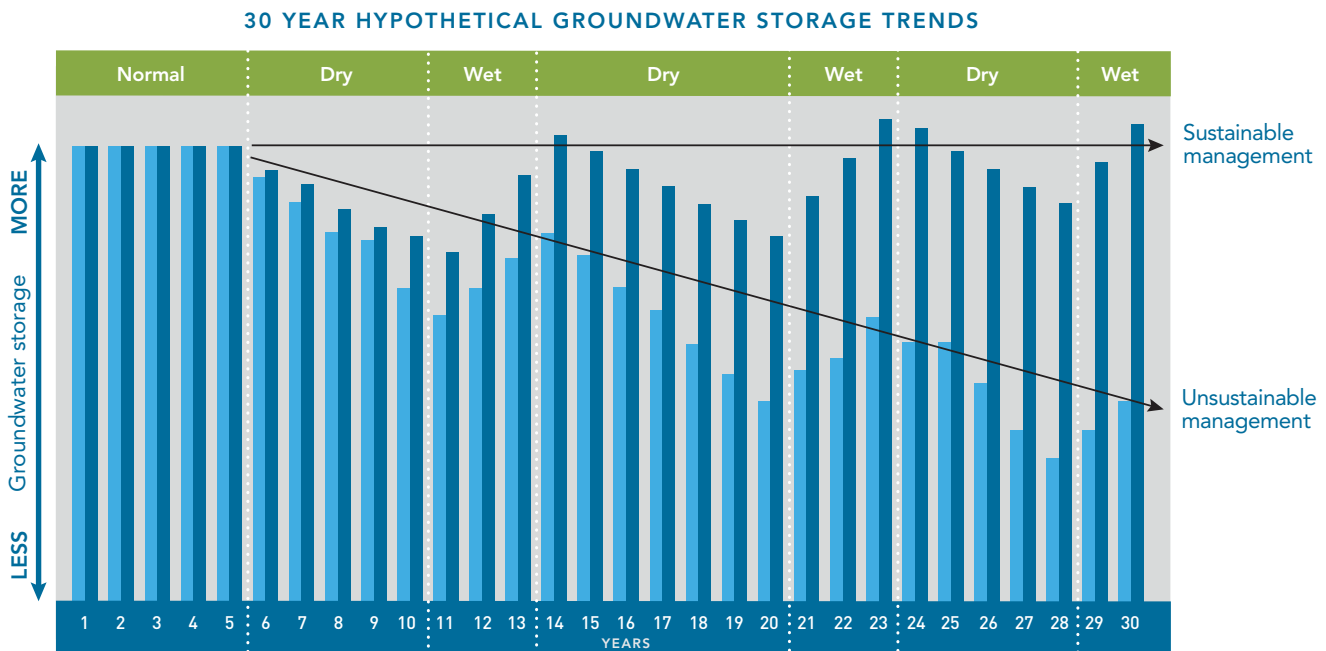

In California's highly variable climate, groundwater storage will fluctuate naturally. In sustainably managed basins, groundwater levels will have more opportunity to recover over time.

What might I be asked to do?

- Coordinate with my neighbors and my Groundwater Sustainability Agency (GSA) in developing a GSP that stabilizes and restores groundwater storage
- Adjust or reduce total pumping volumes
- Participate in or contribute to groundwater recharge programs or projects
- Allow or participate in monitoring endorsed by my GSA

Be involved in your local GSA

SGMA encourages local landowners to work together to develop effective GSPs, and encourages neighboring basins to find common, acceptable solutions. Basins not managed locally, that fail to take corrective action over time, may have plans written and implemented by the State Water Resources Control Board.



Seawater intrusion threatens water supply.

Seawater intrusion occurs in coastal groundwater aquifers when groundwater pumping or sea level rise causes saline groundwater to migrate inland toward freshwater portions of the aquifer, decreasing the capacity of the aquifer to store freshwater and potentially affecting water quality in coastal groundwater wells. SGMA requires that Groundwater Sustainability Plans (GSPs) set forth actions to limit further seawater intrusion in basins where it has occurred due to pumping.

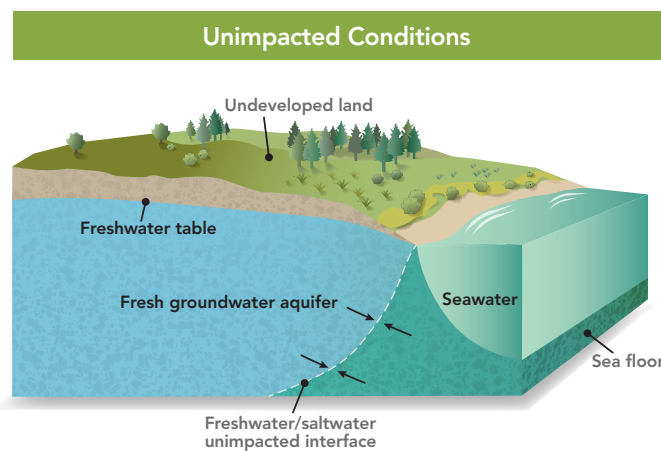

Coastal groundwater under unimpacted conditions.

Under unimpacted conditions, density differences between fresh groundwater and saline groundwater maintain an interface between the two water sources, with less dense, fresh groundwater overlying denser seawater. As groundwater recharge replenishes coastal aquifers, fresh groundwater migrates seaward, preventing seawater from encroaching landward into coastal aquifers. Natural processes maintain this balance.

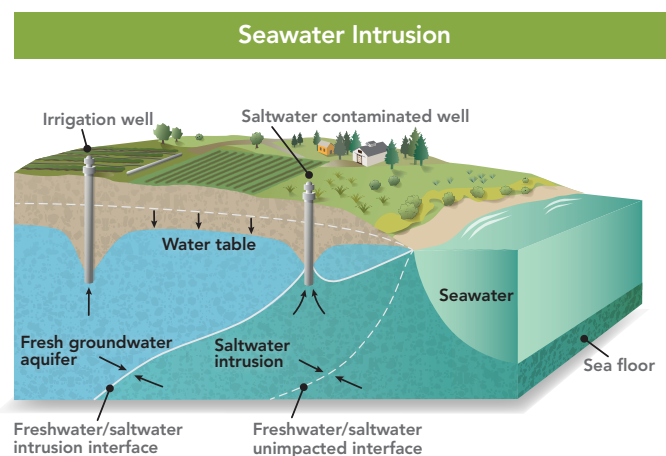

How can seawater intrusion occur?

Seawater intrusion can occur when groundwater pumping lowers water levels in a coastal aquifer, causing saline groundwater to be drawn into freshwater zones of an aquifer. Seawater intrusion may also result from sea level rise where increasing sea levels cause landward encroachment of saline groundwater.

How does seawater intrusion impact me?

Why does seawater intrusion occur?

What is the role of my GSA in preventing seawater intrusion?

Will seawater intrusion affect me and my community?

Seawater intrusion can affect the quality of water supplies obtained from coastal groundwater wells by increasing salt concentrations, which then may require treatment or blending to return groundwater to drinking water or agricultural quality standards. In addition to treatment, management of seawater intrusion may require pumping reduction, managed aquifer recharge, or installing costly freshwater injection wells along the coast to limit further landward migration of saline groundwater.

How can we monitor seawater intrusion to demonstrate the success of our Groundwater Sustainability Plan?

If seawater intrusion is an issue in your basin, the GSP will include a description of historical groundwater data and a monitoring network to assess groundwater elevations and chloride concentrations to identify locations where seawater intrusion has occurred or may occur in the future.

MANAGEMENT ACTIONS TO PREVENT OR REDUCE SEAWATER INTRUSION

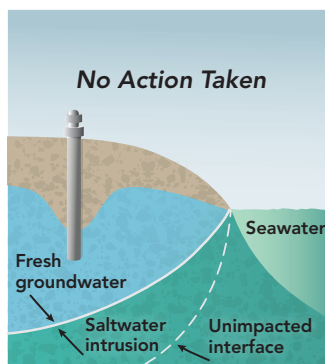

No actions are taken and the coastal aquifer shows seawater intruding.

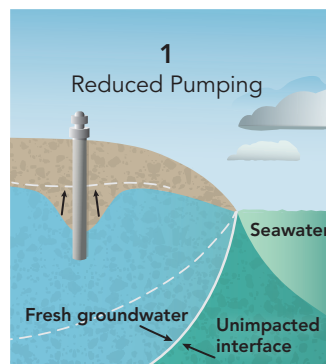

1. Reduced pumping which raises the groundwater level or freshwater barrier over time.

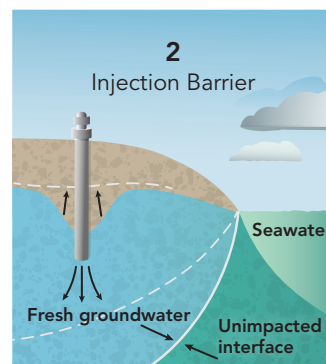

2. A barrier of injection wells which causes seaward migration of the freshwater/saltwater interface.

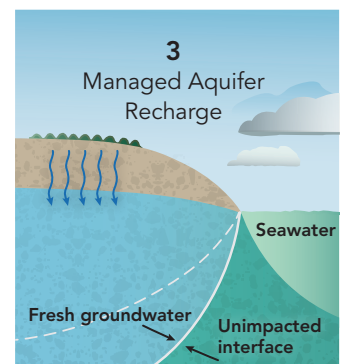

3. Near shore managed aquifer recharge which also causes seaward migration of the freshwater/saltwater interface.

What might I be asked to do?

- Coordinate with my neighbors in development of a GSP through participation in my GSA
- Allow or participate in monitoring endorsed by my GSA
- Adjust or reduce pumping in areas susceptible to seawater intrusion
- Participate in funding projects to manage seawater intrusion

Be involved in your local GSA

SGMA encourages local landowners to work together to develop effective GSPs, and encourages neighboring basins to find common, acceptable solutions. Basins that fail to take corrective action over time may have plans written and implemented by the State Water Resources Control Board.

Degraded Water Quality

The importance of protecting groundwater quality.

Managing groundwater quality is critical to ensure that all beneficial users have access to safe and reliable groundwater supply that meets current and future demands. SGMA requires that Groundwater Sustainability Plans (GSPs) set forth actions to avoid or mitigate degradation of groundwater quality as a result of projects or management actions implemented as part of the GSP.

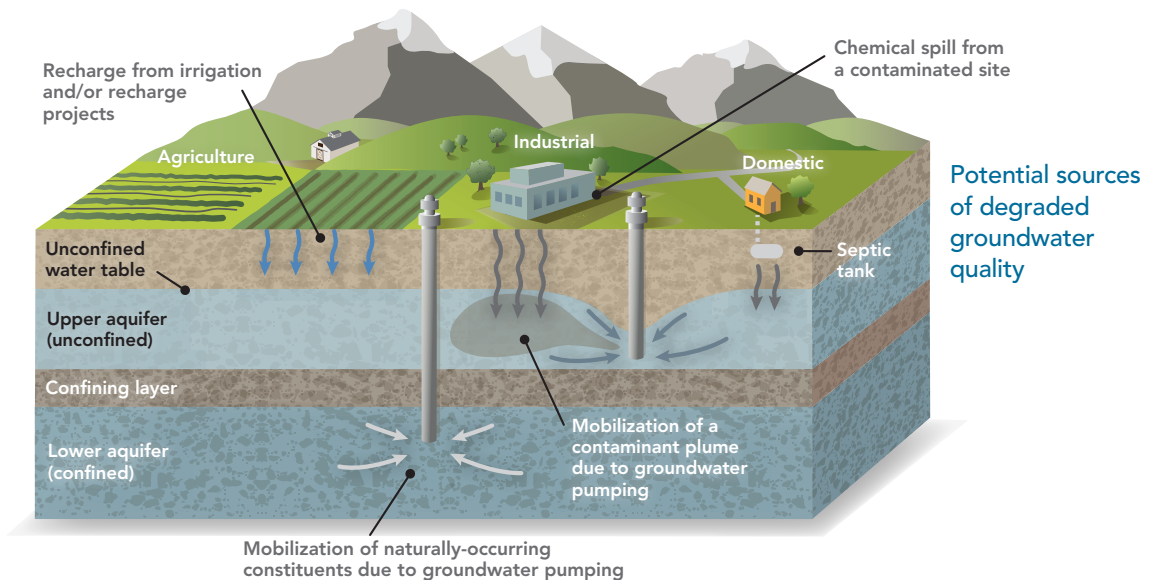

How can groundwater quality be degraded?

Groundwater quality can be impacted by naturally-occurring constituents that can be present in rocks and sediments in an aquifer like arsenic, iron, and manganese. Groundwater quality can also be impacted by industrial and urban activities, including leaking storage tanks and chemical spills. In addition, agricultural practices and domestic septic systems can increase concentrations of nitrate, salts, and other constituents in groundwater.

Will degradation of groundwater quality affect me and my community?

The rock and sediments that make up the aquifer play a large part in determining whether and how pollutants can migrate through the aquifer system and potentially impact wells. Groundwater contamination issues are often localized and may only affect some wells in a basin; once groundwater quality is degraded at a well, costly expenditures may be required, including wellhead water treatment, mixing pumped water with other non-degraded sources of water, or drilling a new well. The GSP will address whether such impacts are significant, unreasonable, and/or occurring throughout the basin.

How can groundwater pumping and recharge affect groundwater quality?

Why does groundwater quality matter?

What is the role of my GSA in protecting groundwater quality?

What is the GSA's role in protecting water quality?

As the main steward of the groundwater basin, the Groundwater Sustainability Agency (GSA) is required to monitor groundwater quality throughout the basin and may act as a proactive "facilitator" to involve existing regulatory agencies and move forward on processes that protect groundwater quality. SGMA requires that projects or management actions implemented as part of the GSP avoid or mitigate degradation of groundwater quality. Importantly, SGMA does not supersede existing regulations set forth by other regulatory agencies, like the State and Regional Control Boards.

How will the GSA address water quality?

It is important for each GSA to gather historical water quality data to identify constituents of concern. The GSP may establish a monitoring network to assess changes in concentrations of specific constituents of concern over time. The GSP may also identify water quality threshold values for specific constituents to trigger actions to avoid undesirable water quality results.

What might I be asked to do?

- Provide water quality data to my GSA
- Allow or participate in water quality monitoring endorsed by my GSA
- Contribute to my GSA to fund annual monitoring and reporting of water quality data.

HYPOTHETICAL GROUNDWATER MONITORING NETWORK

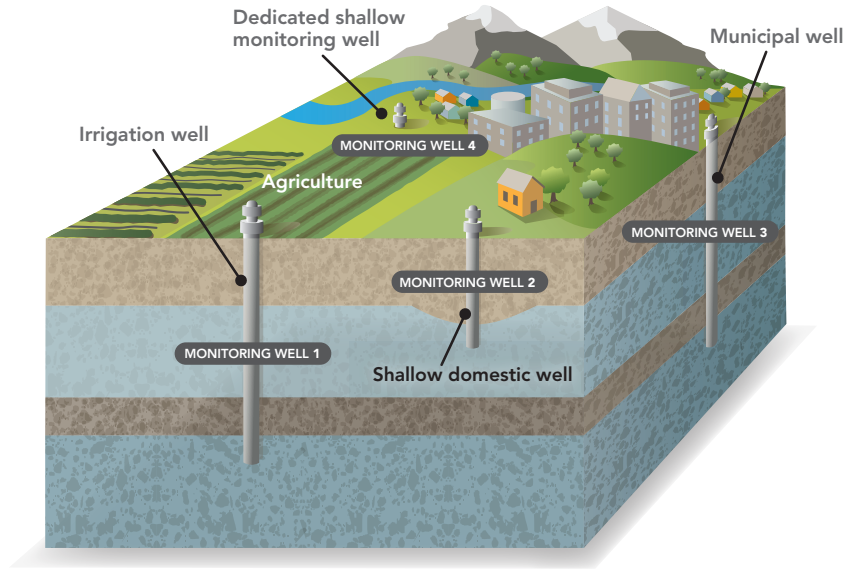

HYPOTHETICAL GROUNDWATER QUALITY TRENDS

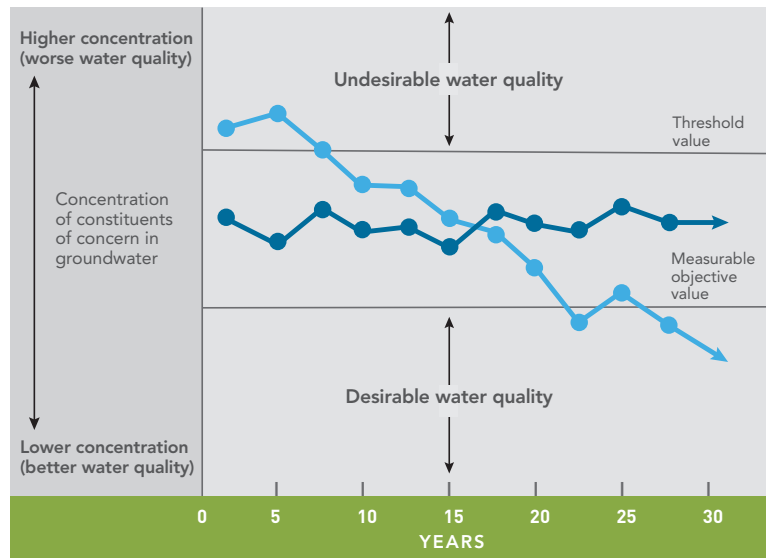

The GSP should focus on achieving either of these two water quality trends.

Be involved in your local GSA

SGMA encourages local landowners to work together to develop effective GSPs, and encourages neighboring basins to find common, acceptable solutions. Basins not managed locally, that fail to take corrective action over time, may have plans written and implemented by the State Water Resources Control Board.

Land Subsidence



NO. 5
 UNDESIRABLE
 RESULT

Land subsidence damages infrastructure and reduces groundwater storage.

Land subsidence is a decline in land surface elevation which may occur due to various factors, including groundwater pumping. In areas with specific underlying geologic conditions, subsidence can damage important infrastructure and cause the permanent loss of groundwater storage capacity. SGMA requires that Groundwater Sustainability Plans (GSPs) set forth actions to limit significant and unreasonable land subsidence in basins where it has occurred due to groundwater pumping.

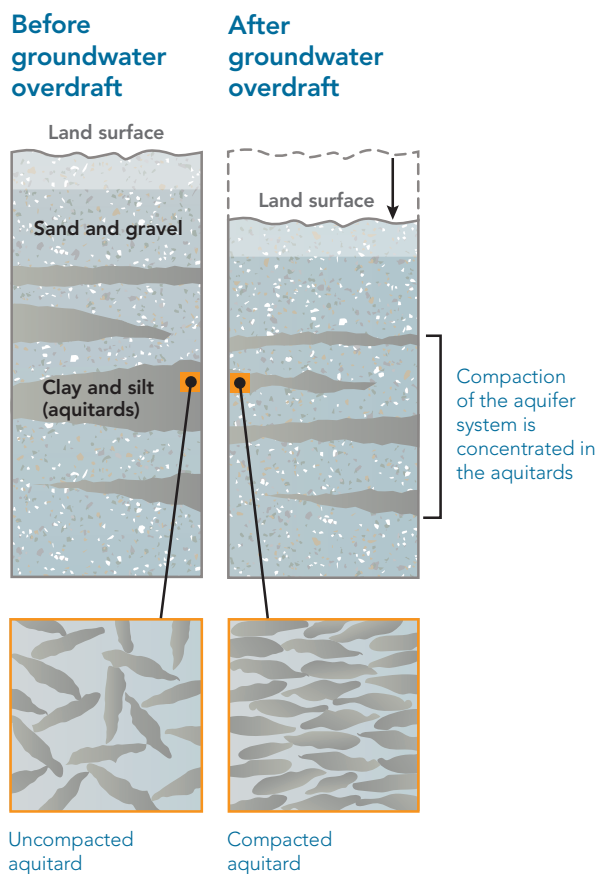

Subsurface geologic conditions determine vulnerability to subsidence.

Subsidence is not prevalent in all groundwater basins or uniform in all areas of an affected basin. Most groundwater basins in California are comprised of sand and gravel aquifers (water-bearing layers that allow groundwater flow) and fine-textured silt and clay aquitards (layers that retard groundwater flow).

Land subsidence can occur when groundwater pumping reduces the pore-water pressure in aquitard layers with high proportions of clay minerals, which causes the individual clay grains to re-orient and collapse, resulting in deformation that may permanently reduce its groundwater storage capacity. This "compaction" deep underground causes the land surface to subside, sometimes rapidly during a severe drought, or progressively over years and decades. Often, aquitards do not uniformly compact, damaging infrastructure which depends on a stable foundation.

Why does land subsidence matter?

What is the role of my GSA in preventing land subsidence?

How does land subsidence occur?

Will land subsidence affect me and my community?

Land subsidence can cause permanent deformation (i.e., sinking) of the ground surface that can seriously damage infrastructure, including water conveyance systems, roads, bridges, building foundations, wells, and levees. Damage to infrastructure can require costly repairs. For example, subsidence has significantly reduced the flow capacity of water conveyance infrastructure in some parts of California (requiring pumps in locations where flow has been disrupted), increased delivery and maintenance costs, and decreased delivery reliability.

How can we monitor land subsidence to demonstrate the success of our Groundwater Sustainability Plan?

The GSP will describe a monitoring effort using remote sensing and/or G.P.S. technology to assess subsidence of the land surface in susceptible basins. The GSP will establish a monitoring program to assess the success of planned actions to stabilize land subsidence. Those actions may include efforts to stabilize groundwater levels via either pumping reduction, managed aquifer recharge, and other approaches.

What might I be asked to do?

- Coordinate with my neighbors and my Groundwater Sustainability Agency (GSA) in developing a GSP that stabilizes land subsidence
- Adjust or reduce groundwater pumping in areas susceptible to land subsidence
- Participate in funding projects to reduce subsidence or repair and rehabilitate damaged infrastructure
- Allow monitoring endorsed by my GSA

IMPACT AFTER SUBSIDENCE

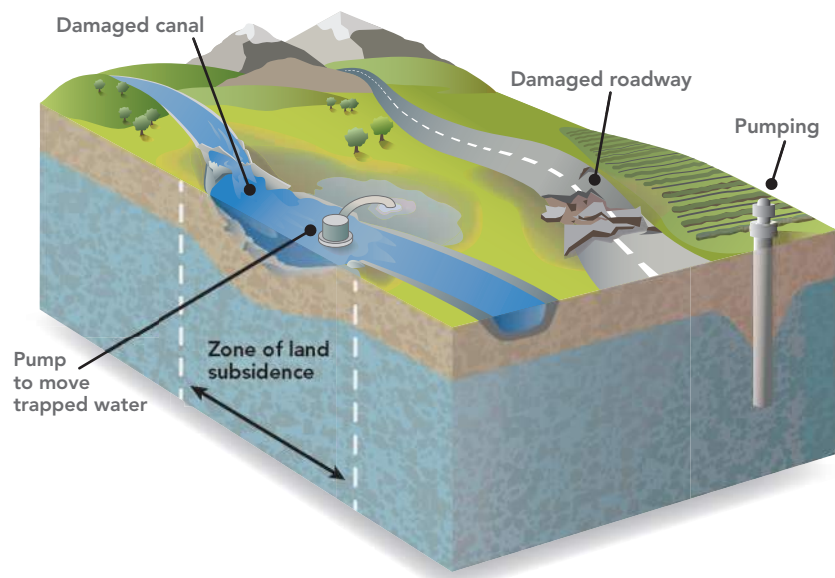

TRANSITION TO SUSTAINABLE LAND SUBSIDENCE

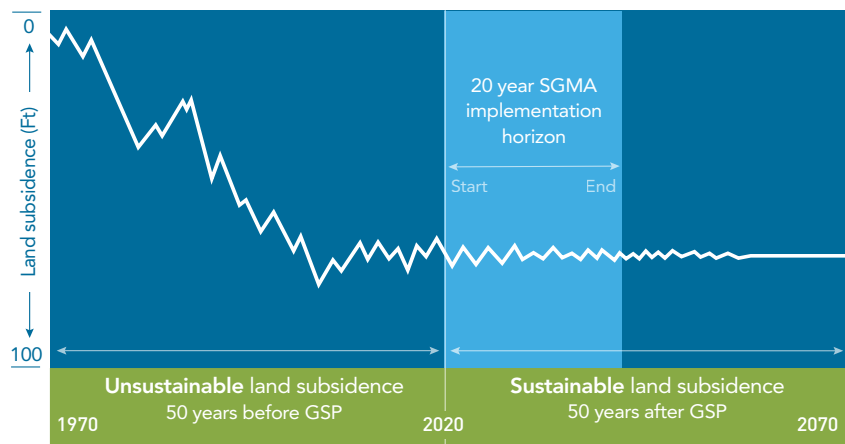

Historical land subsidence is unsustainable and shows a downward negative trend over time. SGMA compliance requires that over the 20 year implementation period, land subsidence reaches sustainable levels as determined by your GSA.

Be involved in your local GSA

SGMA encourages local landowners to work together to develop effective GSPs, and encourages neighboring basins to find common, acceptable solutions. Basins that fail to take corrective action over time may have plans written and implemented by the State Water Resources Control Board.

Groundwater and surface water interactions.

Natural variability is common in streamflow and wetland areas in California. Groundwater may play an important role in surface water ecosystems such as streams, springs, seeps and wetlands. In those cases, groundwater pumping can exacerbate stream depletion and impact wetland ecosystems. In turn, surface water depletion can unreasonably impact fish and other beneficial aquatic uses. Groundwater Sustainability Plans (GSPs) must establish threshold values and set forth actions to avoid this undesirable result.

Flowing surface waters are defined as either gaining or losing streams.

A **gaining stream** (or reach of a stream) is one in which the water level in the stream is lower than the level of the surrounding groundwater table, and groundwater moves from the ground into the channel.

A **losing stream** (or reach) is one in which stream water levels are above the groundwater table, and water moves from the channel into the aquifer.

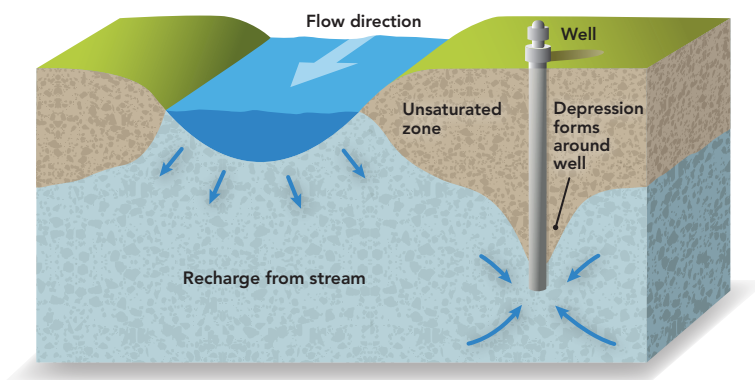
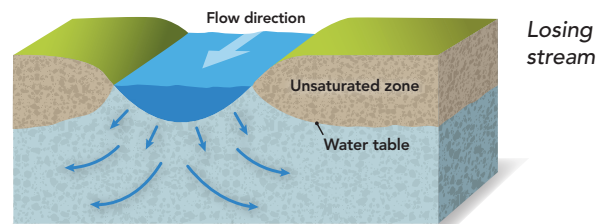
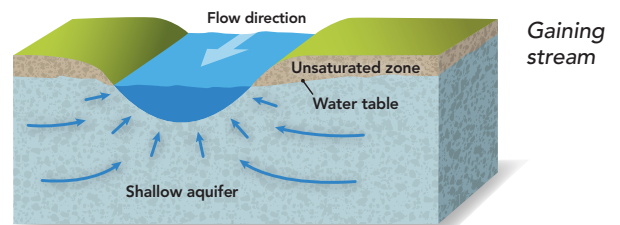

How can groundwater pumping affect surface water levels and flowing streams?

Groundwater pumping, in combination with natural variations and/or reduced recharge, may lower the water table sufficiently to reduce the amount of groundwater that is contributed to a stream. In extreme cases, pumping may disconnect a surface water body from the underlying water table, changing the flow pattern so that a portion of the river actually flows into the aquifer below and may disappear at the ground surface.

Why does surface water depletion matter?

How does groundwater pumping affect surface water?

How might this impact future groundwater pumping?

Will surface water depletions affect me and my community?

How can we monitor groundwater and surface water interactions to demonstrate the success of our plan?

The distance of a well from the river and geologic characteristics at the well location will determine the timing and rate of the depletion in the river, if any. Well operations near streams tend to have a greater impact than pumping

distant from streams; modified operations of these wells may be required to minimize the effect on the stream. The success of such modifications can be measured using groundwater levels and streamflows monitored continuously at key locations. Additionally, measurements of precipitation, evapotranspiration, and soil moisture, in combination with modeling results, can help guide the development of the overall GSP.

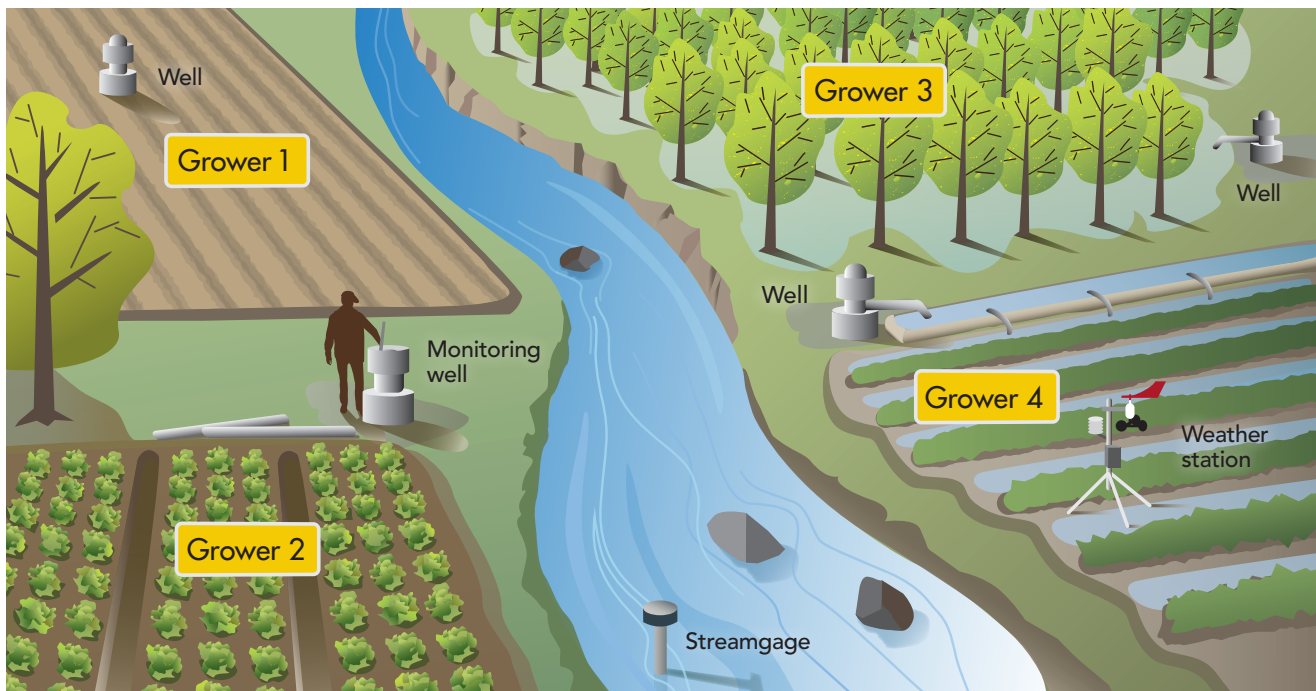

What might I be asked to do?

- Make use of available data (such as evapotranspiration, soil moisture, streamflows) to inform and optimize irrigation practices
- Coordinate with my neighbors regarding the timing and rate of pumping
- Reduce pumping during specific seasons or under certain stream conditions
- Participate in groundwater recharge programs or projects
- Explore off-stream storage options
- Allow or participate in monitoring endorsed by my GSA

Be involved in your local GSA

SGMA encourages local landowners to work together to develop effective GSPs, and encourages neighboring basins to find common, acceptable solutions. Basins not managed locally, that fail to take corrective action over time, may have plans written and implemented by the State Water Resources Control Board.

Regional Coordination Between Subbasins

Antelope | Bowman | Butte | Colusa | Corning | Los Molinos | Red Bluff | Sutter | Vina | Wyandotte Creek | Yolo

Sustainable Groundwater Management Act

What is SGMA? California enacted the Sustainable Groundwater Management Act (SGMA) in 2014 to better manage groundwater over the long term. Sustainability is achieved by avoiding significant and unreasonable conditions for the six "sustainability indicators."



156+/*#4%57%
8/5#\$6".+/%!+9+1)



;\$',.5#%57%
8/5#\$6".+/%&.5/"4+



!"#\$%
&'()*\$+#,+



&/'",+%-".+/%
3+:1+.*5#



-.+/%0"1*.2%
3+4/"\$.*5#



&+"%-".+/%
<#./)"5#

Why is regional coordination important? In the Sacramento Valley, inter-basin coordination is critical as Groundwater Sustainability Agencies (GSA) develop their Groundwater Sustainability Plans (GSP). Since groundwater subbasins in the Northern Sacramento Valley (NSV) are hydrologically interconnected, water management decisions and actions in one subbasin (e.g. groundwater pumping) and processes like climate change could change aquifer conditions and affect flows to other subbasins. Understanding and accounting for these processes is key to achieve sustainability in all subbasins.

Who is involved in ongoing efforts?

Collaborative efforts have begun among representatives from 11 subbasins (Antelope, Bowman, Butte, Colusa, Corning, Los Molinos, Red Bluff, Sutter, Vina, Wyandotte Creek, Yolo), with facilitation support from the Consensus Building Institute. While efforts have focused on the subbasins mentioned, coordination will occur, as warranted, with other neighboring subbasins (Anderson and North Yuba).

What are the coordination priorities?

Groundwater Sustainability Agencies are working together to establish a foundation for open and transparent inter-basin coordination and communication by developing tools to:



SHARE & COMPILE INFORMATION IN A CONSISTENT WAY



OUTLINE A PROCESS TO IDENTIFY & RESOLVE ISSUES



DOCUMENT COORDINATION EFFORTS

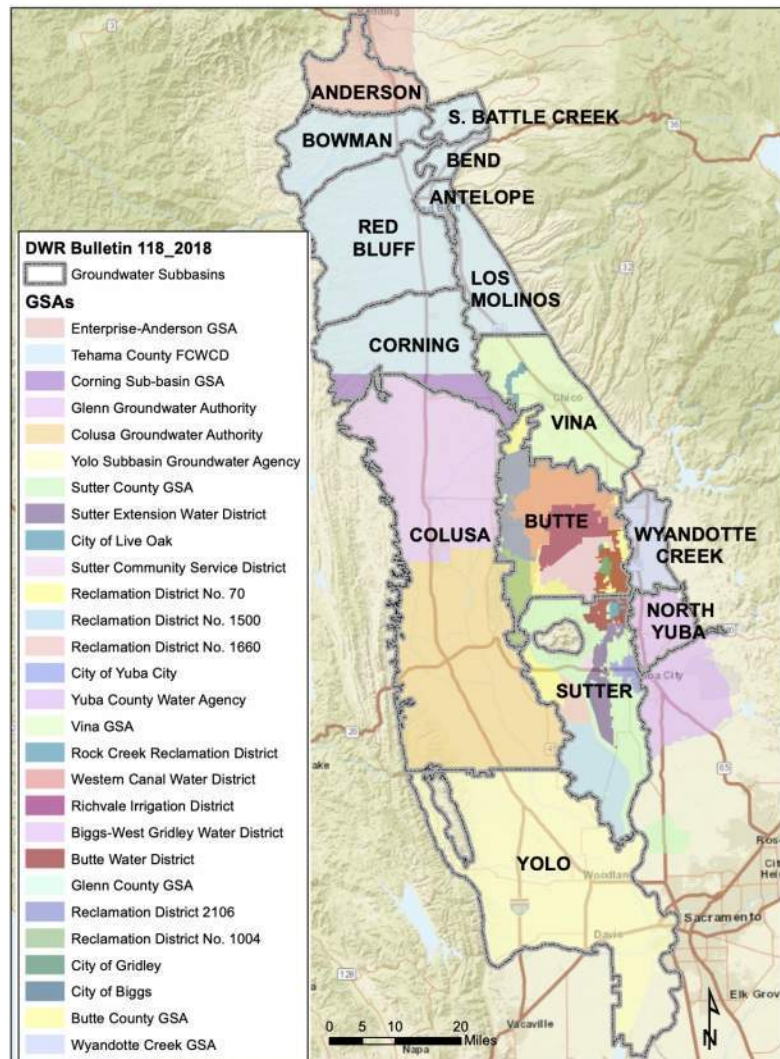

Learn More & Get Involved



Receive Updates

Sign up for your GSA's interested parties list.



Contact Your GSA

Talk to your GSA representative



Attend Meetings

Attend public workshops, Advisory Board, and GSA Board meetings

Subbasin	GSA(s)	Website
Antelope	Tehama County Flood Control and Water Conservation District (FCWCD)	Website
Bowman	Tehama County FCWCD	Website
Butte	Biggs West Gridley WD, Butte County, Butte WD, City of Biggs, City of Gridley, Colusa Groundwater Authority, Glenn County, RD 1004, RD 2106, Richvale ID, Western Canal WD	Website
Los Molinos	Tehama County FCWCD	Website
Red Bluff	Tehama County FCWCD	Website
Corning	Corning Sub-basin GSA, Tehama County FCWCD	Website
Colusa	Glenn Groundwater Authority; Colusa Groundwater Authority	Websites (Glenn) (Colusa)
Sutter	Butte WD, City of Live Oak, Sutter Community Service District, Sutter County, Sutter Extension Water District, RD 70, RD 1660, RD 1500, City of Yuba City	Website
Vina	Rock Creek Reclamation District, Vina GSA	Websites (Vina) (RCDC)
Wyandotte Creek	Wyandotte Creek GSA	Website
Yolo	Yolo Subbasin Groundwater Agency	Website



Find more information about regional inter-basin coordination at:

ButteCounty.net/waterresourceconservation/Sustainable-Groundwater-Management-Act/Inter-basin-Coordination

The website is undergoing scheduled construction.

Resources

News items, technical and related project reports, FAQs, and documents will be posted here, as they become available.

Sutter Subbasin Resources

Fact Sheets

- [SGMA 101 !\[\]\(a9a7cf821bf949be41db724492f295be_img.jpg\)](#)
- [Seawater Intrusion Ca farm Bureau !\[\]\(2c367d84c99049f9805eec6142b5bc5d_img.jpg\)](#)
- [Understanding SGMA CA Farm Bureau !\[\]\(4d6500d074b243a4043016fae28892e4_img.jpg\)](#)
- [Lowering of Groundwater Levels CA Farm Bureau !\[\]\(96ebb722ad5476cd70154c5926aad591_img.jpg\)](#)
- [Groundwater Hydrology CA Farm Bureau !\[\]\(2da405ec9c9a12d2adbd80327dcc4669_img.jpg\)](#)
- [Decrease in Groundwater Storage CA Farm Bureau !\[\]\(e7169cc6d2a044fb61919fa59f1547fc_img.jpg\)](#)
- [Surface Water Depletion CA Farm Bureau !\[\]\(cdea7abd1126d193314f7e947e2be93b_img.jpg\)](#)
- [Land Subsidence CA Farm Bureau !\[\]\(91b2119a889bf130a55ab49421185142_img.jpg\)](#)
- [Degraded Water Quality CA Farm Bureau !\[\]\(31c3707bfe1ee6bd1486b44f4c3a13f0_img.jpg\)](#)

Regional Coordination



- [NSV Coordination Flyer !\[\]\(4f6d8a8b127300a02d56d34d01423d15_img.jpg\)](#)

Sutter Subbasin Documents

[GSP Initial Notification](#)

Public Draft

Public Comments on the Hydrogeologic Conceptual Model section of the Basin Setting chapter (Section 5.1) are due August 9 and on the Groundwater Conditions section of the Basin Setting chapter (Section 5.2) on August 27. Please email public comments to info@suttersubbasin.org and include "Sutter Subbasin GSP HCM comments" or "Sutter Subbasin GSP Groundwater Conditions comments" as appropriate in the subject line.



- [Sutter GSP Section 5.1 HCM PUBLIC DRAFT](#) 
- [Sutter GSP Section 5.2 Groundwater Conditions PUBLIC DRAFT](#) 

Prior Drafts Provided for Comment

Coming Soon

California Department of Water Resources - Groundwater: California's Vital Resources

Videos

- [Groundwater: California's Vital Resource - YouTube](#) 
- [Groundwater: California's Vital Resource SPANISH VERSION - YouTube](#) 
- [Groundwater: California's Vital Resource PUNJABI VERSION - YouTube](#) 

General FAQs

[What is the Sutter Subbasin?](#)

The Sutter Groundwater Subbasin is generally described as being in the "central portion of the Sacramento Valley Groundwater Basin" in DWR's Bulletin 118 (California's Groundwater). It is bounded on the north by the confluence of Butte Creek and the Sacramento River and Sutter Buttes, on the west by the Sacramento River, on the south by the confluence of the Sacramento River and the Sutter Bypass, and on the east by the Feather River and the eastern boundary with the Sutter-Yuba County line.

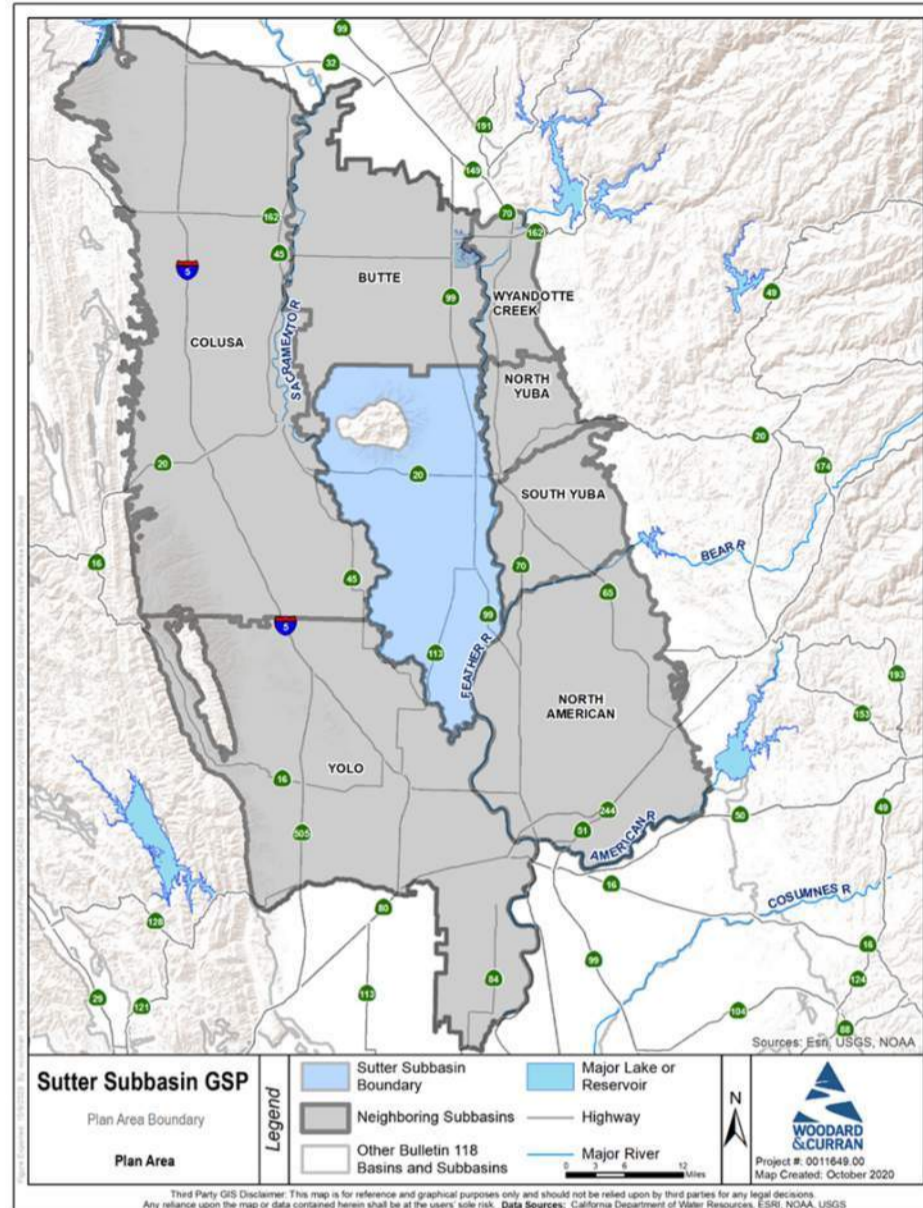

[What does “groundwater sustainability” mean?](#)

[What is the water cycle and how does it relate to groundwater supplies?](#)

[How is the Sutter Subbasin managed?](#)

Compiled from California Department of Water Resources (DWR) documentation

What is SGMA

[What is the Sustainable Groundwater Management Act \(SGMA\)?](#)

The Sustainable Groundwater Management Act, signed into law in 2014, provides a framework for long-term sustainable groundwater management across California. It requires that local and regional authorities in medium- and high-priority groundwater basins form a locally-controlled and governed Groundwater Sustainability Agency (GSA), which will prepare and implement a Groundwater Sustainability Plan (GSP).

[Is SGMA related to the drought?](#)

[Why was the SGMA established?](#)

[Will SGMA affect existing water and property rights?](#)

[Is the State trying to take over control of groundwater?](#)

Who is the GSA

[What is a GSA?](#)

A Groundwater Sustainability Agency (GSA) is one or more local governmental agencies that implement the provisions of SGMA. A local agency is defined as one that has water supply, water management or land management authority. The primary purpose of a GSA under SGMA is to develop and implement a Groundwater Sustainability Plan (GSP) or Alternative Plan to achieve long-term groundwater sustainability.

[Who is the GSA for the Sutter Subbasin?](#)

[What authority will GSAs have?](#)

[Will stakeholders or the public have the opportunity to weigh in on the GSP?](#)

[How are the GSAs working together to prepare and implement the GSP to achieve groundwater sustainability?](#)

[What will be the Governance Structure for the proposed GSA? How will the agencies work together to run it?](#)

[If GSAs are locally controlled, what is the state's role in this effort?](#)

[How will adjacent GSAs be handled?](#)

[Does the GSA impact surface water?](#)

What is the GSP

[What is a Groundwater Sustainability Plan \(GSP\)?](#)

A GSP is the plan of a GSA that provides for sustainably managed groundwater that meets the requirements of SGMA. GSAs in high and medium priority groundwater basins are required to submit a GSP to the California Department of Water Resources. The plan must outline how the GSA will implement, manage and measure specific actions for the health and viability of the basins. DWR will evaluate the GSP and provide the GSA with an assessment of the plan and any necessary recommendations every two years following its establishment.

[When does a GSP have to be established?](#)

[How will the GSP affect local cities and the county?](#)

[How can I get involved in the plan development?](#)

The following links provide additional information about SGMA, Sustainable Groundwater Plans, Groundwater, and Stakeholder Engagement

SGMA and GSP Information

[California Department of Water Resources — SGMA Groundwater Management](#)
[University of California, Davis](#)
[Union of Concerned Scientists](#)
[SGMA Best Management Practices](#)
[Sustainable Groundwater Management Act Portal](#)
[Association of California Water Agencies](#)
[Water Education Foundation SGMA Handbook](#)
[Groundwater Resources Association of California](#)
[California Farm Bureau](#)
[UC Water | Groundwater](#)

Groundwater Sustainability Plans (GSPs)

[Union of Concerned Scientists: Guide to California's Groundwater Sustainability Plans, in English and Spanish](#)

Water and Groundwater

[USGS, 2010 California Water Use](#)
[San Francisco Public Utilities Commission, What is Groundwater?](#) 
[USGS, Water Science School, Groundwater Basics](#)

Stakeholder Engagement for SGMA

[Community Water Center, Union of Concerned Scientists, Clean Water Fund: Stakeholder Guide for Sustainable Groundwater Management Act Implementation](#) 

Previous Studies

[Alternative Plan](#) 

Common Acronyms

DWR = California Department of Water Resources	MOA = Memorandum of Agreement
GSA = Groundwater Sustainability Agency	SGMA = Sustainable Groundwater Management Act
GSP = Groundwater Sustainability Plan	SWRCB = State Water Resources Control Board
JPA = Joint Powers Authority	



For Immediate Release:
Contact: Leslie Dumas
Email: info@suttersubbasin.org
Phone: 916-999-8778

Local Efforts Underway Related to Sutter Groundwater Subbasin Draft Groundwater Sustainability Plan Available for Public Review and Comment

Sutter County, CA: The *Sutter Subbasin Groundwater Sustainability Plan Public Draft* will be made available for a Public Comment Period, anticipated October 1 through November 12. The Draft Plan is available for viewing at www.SutterSubbasin.org, and comments can be submitted to info@suttersubbasin.org.

The nine Groundwater Sustainability Agencies (GSAs) of Sutter Groundwater Subbasin have been preparing a Groundwater Sustainability Plan (GSP) in response to the Sustainable Groundwater Management Act (SGMA). The Sutter Subbasin GSP will be complete by the end of 2021 and adopted prior to the regulatory deadline of January 31, 2022.

To provide information and seek input on the Public Draft GSP, the Groundwater Sustainability Agencies are hosting a workshop on October 19th from 4 p.m. – 6 p.m. The workshop will be held virtually due to COVID-19. This public workshop is a great opportunity to get involved, learn about the GSP contents, and provide input on the future of groundwater management in the Sutter Subbasin.

Sutter Subbasin GSP – Public Workshop #5

Tuesday, October 19, 2021 at 4:00 pm – 6:00 pm

GoToMeeting

Please join my meeting from your computer, tablet or smartphone:

<https://global.gotomeeting.com/join/214694605>.

You can also dial in using your phone: +1 (408) 650-3123, Access Code: 214-694-605

The Groundwater Sustainability Agencies have been hosting a series of public workshops to provide updates on local efforts to meet the State's goals under SGMA. This fifth public workshop will give an overview of the elements included in the Public Draft GSP. The public will have the opportunity to ask questions and provide input on the plan.

To sign up for our stakeholder list or learn more, visit our website: www.SutterSubbasin.org

About Sutter Subbasin:

The nine GSAs overlying the Sutter Subbasin are working together as the Sutter Subbasin Groundwater Management Coordination Committee (SSGMCC). The SSGMCC holds regular coordination meetings to discuss GSP technical development and public outreach and engagement activities in order to prepare a GSP for adoption. Stakeholders play an important role in the successful development of the GSP. Stakeholders have opportunities to comment and provide input into the GSP before key milestone decisions. Visit www.SutterSubbasin.org for more information.



Para publicación inmediata:

Contacto: Leslie Dumas

Correo electrónico: info@suttersubbasin.org

Teléfono: 916-999-8778

Esfuerzos locales en marcha asociados a la Subcuenca de agua subterránea de Sutter

El borrador del Plan de Sostenibilidad del Agua Subterránea (Groundwater Sustainability Plan) está disponible para revisión y comentario público

Condado de Sutter, CA: El Borrador público del Plan de Sostenibilidad del agua subterránea de la Subcuenca de Sutter estará disponible durante el periodo de comentario público, que se anticipa será entre el 1º de octubre y el 12 de noviembre. El Borrador del Plan estará disponible para consulta en www.SutterSubbasin.org, y los comentarios se pueden enviar a info@suttersubbasin.org.

Las nueve Agencias de sostenibilidad del agua subterránea (Groundwater Sustainability Agencies, GSA) de la Subcuenca de agua subterránea de Sutter han estado preparando un Plan de sostenibilidad del agua subterránea (Groundwater Sustainability Plan, GSP) en respuesta a la Ley de gestión sostenible del agua subterránea (Sustainable Groundwater Management Act, SGMA). El GSP de la Subcuenca de Sutter se concluirá a fines de 2021, y se aprobará antes del plazo límite regulatorio del 31 de enero de 2022.

Para brindar información y pedir opiniones sobre el Borrador público del GSP, las Agencias de sostenibilidad del agua subterránea (Groundwater Sustainability Agencies) celebrarán un taller el 19 de octubre, de 4 p.m. a 6 p.m. El taller se realizará virtualmente debido a la COVID-19. Este taller público es una excelente oportunidad para involucrarse, aprender sobre los contenidos del GSP y dar su opinión sobre el futuro de la gestión del agua subterránea en la Subcuenca de Sutter.

GSP de la Subcuenca de Sutter – Taller público n.º 5

Martes, 19 de octubre de 2021, de 4:00 pm a 6:00 pm

GoToMeeting

Únase a mi reunión desde su computadora, tableta o teléfono inteligente:

<https://global.gotomeeting.com/join/214694605>.

También puede marcar usando su teléfono: +1 (408) 650-3123, Código de acceso: 214-694-605

Las Agencias de Sostenibilidad del Agua Subterránea han estado celebrando una serie de talleres públicos para ofrecer novedades sobre los esfuerzos locales por cumplir las metas del Estado bajo la ley SGMA. Este quinto taller público dará una visión general de los elementos incluidos en el Borrador público del GSP. El público tendrá la oportunidad de hacer preguntas y dar sus opiniones sobre el plan.

Para inscribirse en nuestra lista de actores interesados o para obtener más información, visite nuestro sitio web: www.SutterSubbasin.org

Acerca de la Subcuenca de Sutter:

Las nueve GSA sobre la Subcuenca de Sutter están trabajando juntas como Comité de coordinación de la gestión del agua subterránea de la Subcuenca de Sutter (Sutter Subbasin Groundwater Management Coordination Committee, SSGMCC). El SSGMCC mantiene reuniones de

coordinación regulares para analizar el desarrollo técnico del GSP y actividades de difusión y participación del público a fin de preparar un GSP para su aprobación. Los actores interesados desempeñan un rol importante el desarrollo exitoso del GSP. Los actores interesados tienen oportunidades de comentar y hacer aportaciones al GSP antes de que se tomen decisiones sobre hitos clave. Visite www.SutterSubbasin.org para obtener más información.



ਤੱਤਕਾਲੀ ਰਿਲੀਜ਼ ਲਈ:

ਸੰਪਰਕ: ਲੀਸਲੀ ਦੁਮਾਸ

ਈਮੇਲ: info@suttersubbasin.org

ਫੋਨ: 916-999-8778

ਸਟਰ ਗ੍ਰਾਊਂਡਵਾਟਰ ਸਬਬੇਸਿਨ ਨਾਲ ਸਬਿੰਤ ਸਥਾਨਕ ਕੋਸ਼ਿਸ਼ਾਂ ਪ੍ਰਕਿਰਿਆ ਅਧੀਨ ਹਨ
ਜਨਤਕ ਸਮੀਖਿਆ ਅਤੇ ਟਿੱਪਣੀ ਲਈ ਡ੍ਰਾਫਟ ਗ੍ਰਾਊਂਡਵਾਟਰ ਸਸਟੇਨੇਬਲਿਟੀ ਪਲਾਨ ਉਪਲਬਧ ਹੈ

ਸਟਰ ਕਾਉਂਟੀ, ਸੀਏ: ਸਟਰ ਸਬਬੇਸਿਨ ਗ੍ਰਾਊਂਡਵਾਟਰ ਸਸਟੇਨੇਬਲਿਟੀ ਪਲਾਨ ਪਬਲਿਕ ਡ੍ਰਾਫਟ ਨੂੰ ਜਨਤਕ ਟਿੱਪਣੀ ਕਾਲ ਲਈ 1 ਅਕਤੂਬਰ ਤੋਂ 12 ਨਵੰਬਰ ਤੱਕ ਉਪਲਬਧ ਕਰਵਾਏ ਜਾਣ ਦੀ ਉਮੀਦ ਹੈ। ਡ੍ਰਾਫਟ ਪਲਾਨ www.SutterSubbasin.org, 'ਤੇ ਦੇਖਣ ਲਈ ਉਪਲਬਧ ਹੈ, ਅਤੇ ਟਿੱਪਣੀਆਂ info@suttersubbasin.org 'ਤੇ ਸਬਮਿਟ ਕੀਤੀਆਂ ਜਾ ਸਕਦੀਆਂ ਹਨ।

ਸਟਰ ਗ੍ਰਾਊਂਡਵਾਟਰ ਸਬਬੇਸਿਨ ਦੀਆਂ ਨੌਂ ਗ੍ਰਾਊਂਡਵਾਟਰ ਸਸਟੇਨੇਬਲਿਟੀ ਏਜੰਸੀਆਂ (GSAs) ਸਸਟੇਨੇਬਲ ਗ੍ਰਾਊਂਡਵਾਟਰ ਮੈਨੇਜਮੈਂਟ ਐਕਟ (SGMA) ਦੀ ਪ੍ਰਤੀਕਿਰਿਆ ਵਿੱਚ ਗ੍ਰਾਊਂਡਵਾਟਰ ਸਸਟੇਨੇਬਲਿਟੀ ਪਲਾਨ (GSP) ਤਿਆਰ ਕਰ ਰਹੀਆਂ ਹਨ। ਸਟਰ ਸਬਬੇਸਿਨ GSP 2021 ਦੀ ਸਮਾਪਤੀ ਤੱਕ ਪੂਰੀ ਹੋਵੇਗੀ ਅਤੇ 31 ਜਨਵਰੀ, 2022 ਦੀ ਰੈਗੂਲੇਟਰੀ ਸਮਾਂ-ਸੀਮਾ ਤੋਂ ਪਹਿਲਾਂ ਗ੍ਰਹਿਣ ਕੀਤਾ ਜਾਵੇਗਾ।

ਜਾਣਕਾਰੀ ਦੇਣ ਲਈ ਅਤੇ ਪਬਲਿਕ ਡ੍ਰਾਫਟ GSP 'ਤੇ ਇਨਪੁਟ ਦੀ ਮੰਗ ਕਰਨ ਲਈ, ਗ੍ਰਾਊਂਡਵਾਟਰ ਸਸਟੇਨੇਬਲਿਟੀ ਏਜੰਸੀਆਂ 19 ਅਕਤੂਬਰ ਨੂੰ ਸ਼ਾਮ 4 ਵਜੇ - 6 ਵਜੇ ਇੱਕ ਵਰਕਸ਼ਾਪ ਆਯੋਜਿਤ ਕਰਨ ਜਾ ਰਹੀਆਂ ਹਨ। ਕੋਵਿਡ-19 ਕਾਰਨ ਵਰਕਸ਼ਾਪ ਵਰਚੁਅਲੀ ਹੋਵੇਗੀ। ਇਹ ਪਬਲਿਕ ਵਰਕਸ਼ਾਪ ਸ਼ਾਮਲ ਹੋਣ, ਸਟਰ ਸਬਬੇਸਿਨ GSP ਦੀ ਸਮੱਗਰੀ ਬਾਰੇ ਜਾਣਨ ਅਤੇ ਸਟਰ ਸਬਬੇਸਿਨ ਵਿੱਚ ਗ੍ਰਾਊਂਡਵਾਟਰ ਮੈਨੇਜਮੈਂਟ ਦੇ ਭਵਿੱਖ 'ਤੇ ਇਨਪੁਟ ਦੇਣ ਦਾ ਵਧੀਆ ਮੌਕਾ ਹੈ।

ਸਟਰ ਸਬਬੇਸਿਨ GSP - ਪਬਲਿਕ ਵਰਕਸ਼ਾਪ #5

ਮੰਗਲਵਾਰ, 19 ਅਕਤੂਬਰ, 2021 ਸ਼ਾਮ 4:00 - 6:00 ਵਜੇ

ਮੀਟਿੰਗ 'ਤੇ ਜਾਓ

ਕਿਰਪਾ ਕਰਕੇ ਆਪਣੇ ਕੰਪਿਊਟਰ, ਟੈਬਲੇਟ ਜਾਂ ਸਮਾਰਟਫੋਨ ਤੋਂ ਆਪਣੀ ਮੀਟਿੰਗ ਜੁਆਇਨ ਕਰੋ:

<https://global.gotomeeting.com/join/214694605>.

ਤੁਸੀਂ ਆਪਣੇ ਫੋਨ ਤੋਂ ਵੀ ਡਾਇਲ ਕਰ ਸਕਦੇ ਹੋ: +1 (408) 650-3123, ਅਕਸੈਸ ਕੋਡ: 214-694-605

ਗ੍ਰਾਊਂਡਵਾਟਰ ਸਸਟੇਨੇਬਲਿਟੀ ਏਜੰਸੀਆਂ SGMA ਦੇ ਤਹਿਤ ਰਾਜ ਦੇ ਟੀਚਿਆਂ ਨੂੰ ਪੂਰਾ ਕਰਨ ਲਈ ਸਥਾਨਕ ਜਤਨਾਂ 'ਤੇ ਅਪਡੇਟ ਦੇਣ ਲਈ ਪਬਲਿਕ ਵਰਕਸ਼ਾਪਾਂ ਦੀ ਸਿਰੀਜ਼ ਆਯੋਜਿਤ ਕਰ ਰਹੀਆਂ ਹਨ। ਇਹ ਪੰਜਵੀਂ ਪਬਲਿਕ

ਵਰਕਸ਼ਾਪ ਪਬਲਿਕ ਡ੍ਰਾਫਟ GSP ਵਿੱਚ ਸ਼ਾਮਿਲ ਤੱਤਾਂ ਦਾ ਸੰਖਿਪਤ ਵਿਵਰਣ ਦੇਵੇਗੀ। ਜਨਤਾ ਕੋਲ ਸਵਾਲ ਪੁੱਛਣ ਅਤੇ ਪਲਾਨ 'ਤੇ ਇਨਪੁਟ ਦੇਣ ਦਾ ਇੱਕ ਮੌਕਾ ਹੋਵੇਗਾ।

ਸਾਡੀ ਹਿੱਸੇਦਾਰ ਸੂਚੀ ਲਈ ਸਾਇਨ ਅਪ ਕਰਨ ਵਾਸਤੇ ਜਾਂ ਜ਼ਿਆਦਾ ਜਾਣਕਾਰੀ ਲਈ, ਸਾਡੀ ਵੈਬਸਾਈਟ:

www.SutterSubbasin.org 'ਤੇ ਜਾਓ।

ਸਟਰ ਸਬਬੇਸਿਨ ਬਾਰੇ:

ਸਟਰ ਸਬਬੇਸਿਨ 'ਤੇ ਨਿਰਭਰ ਨੌਂ GSAs ਮਿਲ ਕੇ ਸਟਰ ਸਬਬੇਸਿਨ ਗ੍ਰਾਊਂਡਵਾਟਰ ਮੈਨੇਜਮੈਂਟ ਕੋਰਡੀਨੇਸ਼ਨ ਕਮੇਟੀ (SSGMCC) ਦੇ ਤੌਰ 'ਤੇ ਕੰਮ ਕਰ ਰਹੇ ਹਨ। SSGMCC GSP ਟੈਕਨੀਕਲ ਵਿਕਾਸ ਦੀ ਚਰਚਾ ਕਰਨ ਲਈ ਨਿਯਮਿਤ ਕੋਰਡੀਨੇਸ਼ਨ ਮੀਟਿੰਗਾਂ ਕਰਦਾ ਹੈ ਤੇ ਜਨਤਕ ਪਹੁੰਚ ਕਰਦਾ ਹੈ ਅਤੇ ਸਵੀਕਾਰ ਕਰਨ ਲਈ GSP ਤਿਆਰ ਕਰਨ ਲਈ ਸ਼ਮੂਲੀਅਤ ਗਤੀਵਿਧੀਆਂ ਕਰਦਾ ਹੈ। ਹਿੱਸੇਦਾਰ GSP ਦੇ ਸਫਲ ਵਿਕਾਸ ਵਿੱਚ ਅਹਿਮ ਭੂਮਿਕਾ ਅਦਾ ਕਰਦੇ ਹਨ। ਹਿੱਸੇਦਾਰਾਂ ਕੋਲ ਕੁਮੈਂਟ ਕਰਨ ਅਤੇ ਮੁੱਖ ਨਿਰਣਿਆਂ ਤੋਂ ਪਹਿਲਾਂ GSP ਵਿੱਚ ਇਨਪੁਟ ਦੇਣ ਦੇ ਮੌਕੇ ਹੁੰਦੇ ਹਨ। ਜ਼ਿਆਦਾ ਜਾਣਕਾਰੀ ਲਈ www.SutterSubbasin.org 'ਤੇ ਜਾਓ।

Contact ABC10

If you wish to contact a specific ABC10 Employee, you may do so by selecting their name on the [ABC10 Bio page](#).

Phone Numbers

Main Number:

Tel: [\(916\) 441-2345](tel:(916)441-2345)

Fax: [\(916\) 321-3384](tel:(916)321-3384)

News Hotline:

Tel: [\(916\) 321-3300](tel:(916)321-3300)

Fax: [\(916\) 447-6107](tel:(916)447-6107)

Text: [\(916\) 321-3310](tel:(916)321-3310)

Weather Reports:

Tel: [\(916\) 321-3204](tel:(916)321-3204)

Business & Administration:

[\(916\) 321-3211](tel:(916)321-3211)

Assignment Desk

Tel: [\(916\) 321-3300](tel:(916)321-3300)

desk@abc10.com

Website Problems

Tel: [\(916\) 321-3416](tel:(916)321-3416)

Sales:

Tel: [\(916\) 321-3219](tel:(916)321-3219)

Fax: [\(916\) 441-3054](tel:(916)441-3054)

Programming:

Tel: [\(916\) 321-3430](tel:(916)321-3430)

Public Relations:

Tel: [\(916\) 321-3434](tel:(916)321-3434)

Fax: [\(916\) 441-3145](tel:(916)441-3145)

Technical Team:

Tel: [\(916\) 321-3386](tel:(916)321-3386)

Fax: [\(916\) 321-3275](tel:(916)321-3275)

News Room:

[\(916\) 321-3300](tel:(916)321-3300)

Address

Street Address:

ABC10

400 Broadway

Sacramento, CA 95818-2098

Mailing Address:

ABC10

400 Broadway

Sacramento, CA 95818-2098

Driving Directions

From Points North:

Take Interstate 5 South to Sacramento. Just past downtown Sacramento, take the Highway 99/Highway 50 exit. Halfway through the transition ramp, exit the freeway on to X Street. At the base of the ramp, turn right and drive one block to ABC10.

From Points South:

Take Interstate 5 north to Sacramento. As you approach the city center, you will see an exit for Business 80/Highway 99/Highway 50. Take the exit. Halfway through the transition ramp, exit the freeway on to Broadway. At the base of the ramp turn right, and drive one block to ABC10.

From Points West:

Take I-80 eastbound. As you enter West Sacramento do not take the exit to Reno. Instead, stay on Business 80 (the Capitol City Freeway). Just after the highway crosses the Sacramento River, you will see an exit for 5th Street. Take the exit, and then turn right at the base of the ramp. Drive one block down 5th, and then turn right on Broadway, and drive half a block to ABC10.

From Points East:

Take Highway 50 or Interstate 80 westbound. If you are traveling on I-80, transition to Business 80 (the Capitol City Freeway). If you are taking US-50, follow it until it becomes Interstate 80. Look for the 10th Street exit. Take that exit, and continue straight at the base of the ramp (you are now on W Street). Continue until the road dead-ends at 3rd Street. Turn left at 3rd, drive two blocks, and you're at ABC10.

E-mail Us!

Press Release: Local Efforts Underway Related to Sutter Groundwater Subbasin

1 message

Sutter Subbasin <info@suttersubbasin.org>

Fri, Oct 1, 2021 at 9:45 AM

To: adnewsroom@appealdemocrat.com

Cc: Guadalupe Rivera <grivera@co.sutter.ca.us>, Leslie Dumas <ldumas@woodardcurran.com>, Natalie Cochran <ncochran@woodardcurran.com>, vdeanda@woodardcurran.com

Hello,

The attached press release is regarding the *Sutter Subbasin Groundwater Sustainability Plan Public Draft*, which will be made available for public review and comment October 1, 2021.

Water is vital to the economy, the environment, and the quality of life in Sutter County. While this precious resource is visible every day in the Sacramento and Feather Rivers, water underground is no less important, providing about half of the region's water supply. Groundwater serves the needs of cities, farms and businesses and provides high quality drinking water to urban and rural residents, all while helping to sustain vital ecosystems.

We invite the public to join us and learn about the condition and future health of our groundwater subbasin. Members of the public can participate in the process to understand what needs to be done to protect the quality and availability of this valuable resource. Learn why maintaining a sustainable groundwater subbasin matters to the economy, environment, and quality of life of our urban and rural communities.

Please feel free to reach out with any further questions.

Thank you,

Guadalupe Rivera on behalf of Sutter Subbasin GSAs
Sutter County Development Services



Press Release_Public Draft Sutter Subbasin GSP_29Sept21.pdf

410K

Press Release: Local Efforts Underway Related to Sutter Groundwater Subbasin

1 message

Sutter Subbasin <info@suttersubbasin.org>

Fri, Oct 1, 2021 at 9:44 AM

To: news@kovr.com

Cc: Guadalupe Rivera <grivera@co.sutter.ca.us>, Leslie Dumas <ldumas@woodardcurran.com>, Natalie Cochran <ncochran@woodardcurran.com>, vdeanda@woodardcurran.com

Hello,

The attached press release is regarding the *Sutter Subbasin Groundwater Sustainability Plan Public Draft*, which will be made available for public review and comment October 1, 2021.

Water is vital to the economy, the environment, and the quality of life in Sutter County. While this precious resource is visible every day in the Sacramento and Feather Rivers, water underground is no less important, providing about half of the region's water supply. Groundwater serves the needs of cities, farms and businesses and provides high quality drinking water to urban and rural residents, all while helping to sustain vital ecosystems.

We invite the public to join us and learn about the condition and future health of our groundwater subbasin. Members of the public can participate in the process to understand what needs to be done to protect the quality and availability of this valuable resource. Learn why maintaining a sustainable groundwater subbasin matters to the economy, environment, and quality of life of our urban and rural communities.

Please feel free to reach out with any further questions.

Thank you,

Guadalupe Rivera on behalf of Sutter Subbasin GSAs
Sutter County Development Services



Press Release_Public Draft Sutter Subbasin GSP_29Sept21.pdf

410K

Press Release: Local Efforts Underway Related to Sutter Groundwater Subbasin

1 message

Sutter Subbasin <info@suttersubbasin.org>

Fri, Oct 1, 2021 at 9:46 AM

To: News@fox40.com

Cc: Guadalupe Rivera <grivera@co.sutter.ca.us>, Leslie Dumas <ldumas@woodardcurran.com>, Natalie Cochran <ncochran@woodardcurran.com>, vdeanda@woodardcurran.com

Hello,

The attached press release is regarding the *Sutter Subbasin Groundwater Sustainability Plan Public Draft*, which will be made available for public review and comment October 1, 2021.

Water is vital to the economy, the environment, and the quality of life in Sutter County. While this precious resource is visible every day in the Sacramento and Feather Rivers, water underground is no less important, providing about half of the region's water supply. Groundwater serves the needs of cities, farms and businesses and provides high quality drinking water to urban and rural residents, all while helping to sustain vital ecosystems.

We invite the public to join us and learn about the condition and future health of our groundwater subbasin. Members of the public can participate in the process to understand what needs to be done to protect the quality and availability of this valuable resource. Learn why maintaining a sustainable groundwater subbasin matters to the economy, environment, and quality of life of our urban and rural communities.

Please feel free to reach out with any further questions.

Thank you,

Guadalupe Rivera on behalf of Sutter Subbasin GSAs
Sutter County Development Services



 **Press Release_Public Draft Sutter Subbasin GSP_29Sept21.pdf**
410K

Press Release: Local Efforts Underway Related to Sutter Groundwater Subbasin

1 message

Sutter Subbasin <info@suttersubbasin.org>

Fri, Oct 1, 2021 at 9:50 AM

To: publisher@mpg8.com

Cc: Guadalupe Rivera <grivera@co.sutter.ca.us>, Leslie Dumas <ldumas@woodardcurran.com>, Natalie Cochran <ncochran@woodardcurran.com>, vdeanda@woodardcurran.com

Hello,

The attached press release is regarding the *Sutter Subbasin Groundwater Sustainability Plan Public Draft*, which will be made available for public review and comment October 1, 2021.

Water is vital to the economy, the environment, and the quality of life in Sutter County. While this precious resource is visible every day in the Sacramento and Feather Rivers, water underground is no less important, providing about half of the region's water supply. Groundwater serves the needs of cities, farms and businesses and provides high quality drinking water to urban and rural residents, all while helping to sustain vital ecosystems.

We invite the public to join us and learn about the condition and future health of our groundwater subbasin. Members of the public can participate in the process to understand what needs to be done to protect the quality and availability of this valuable resource. Learn why maintaining a sustainable groundwater subbasin matters to the economy, environment, and quality of life of our urban and rural communities.

Please feel free to reach out with any further questions.

Thank you,

Guadalupe Rivera on behalf of Sutter Subbasin GSAs
Sutter County Development Services



 **Press Release_Public Draft Sutter Subbasin GSP_29Sept21.pdf**
410K



Submission Confirmation

1 message

KUBA <mreisz01@gmail.com>
To: info@suttersubbasin.org

Fri, Oct 1, 2021 at 10:30 AM

Name: Natalie Cochran
Email: info@suttersubbasin.org
Who is
this
message
for:: Chris Rey, Operations Manager

Message: The press release included below is regarding the Sutter Subbasin Groundwater Sustainability Plan Public Draft, which will be made available for public review and comment October 1, 2021.

Water is vital to the economy, the environment, and the quality of life in Sutter County. While this precious resource is visible every day in the Sacramento and Feather Rivers, water underground is no less important, providing about half of the region's water supply. Groundwater serves the needs of cities, farms and businesses and provides high quality drinking water to urban and rural residents, all while helping to sustain vital ecosystems.

We invite the public to join us and learn about the condition and future health of our groundwater subbasin. Members of the public can participate in the process to understand what needs to be done to protect the quality and availability of this valuable resource. Learn why maintaining a sustainable groundwater subbasin matters to the economy, environment, and quality of life of our urban and rural communities.

Please feel free to reach out with any further questions.

Sutter County, CA: The Sutter Subbasin Groundwater Sustainability Plan Public Draft will be made available for a Public Comment Period, anticipated October 1 through November 12. The Draft Plan is available for viewing at www.SutterSubbasin.org, and comments can be submitted to info@suttersubbasin.org.

The nine Groundwater Sustainability Agencies (GSAs) of Sutter Groundwater Subbasin have been preparing a Groundwater Sustainability Plan (GSP) in response to the Sustainable Groundwater Management Act (SGMA). The Sutter Subbasin GSP will be complete by the end of 2021 and adopted prior to the regulatory deadline of January 31, 2022.

To provide information and seek input on the Public Draft GSP, the Groundwater Sustainability Agencies are hosting a workshop on October 19th from 4 p.m. – 6 p.m. The workshop will be held virtually due to COVID-19. This public workshop is a great

opportunity to get involved, learn about the GSP contents, and provide input on the future of groundwater management in the Sutter Subbasin.

Sutter Subbasin GSP – Public Workshop #5

Tuesday, October 19, 2021 at 4:00 pm – 6:00 pm

GoToMeeting

Please join my meeting from your computer, tablet or smartphone:

<https://global.gotomeeting.com/join/214694605>.

You can also dial in using your phone: +1 (408) 650-3123, Access Code: 214-694-605

The Groundwater Sustainability Agencies have been hosting a series of public workshops to provide updates on local efforts to meet the State's goals under SGMA. This fifth public workshop will give an overview of the elements included in the Public Draft GSP. The public will have the opportunity to ask questions and provide input on the plan.

To sign up for our stakeholder list or learn more, visit our website:

www.SutterSubbasin.org

About Sutter Subbasin:

The nine GSAs overlying the Sutter Subbasin are working together as the Sutter Subbasin Groundwater Management Coordination Committee (SSGMCC). The SSGMCC holds regular coordination meetings to discuss GSP technical development and public outreach and engagement activities in order to prepare a GSP for adoption. Stakeholders play an important role in the successful development of the GSP. Stakeholders have opportunities to comment and provide input into the GSP before key milestone decisions. Visit www.SutterSubbasin.org for more information.

This page intentionally left blank.

The Appeal

DEMOCRAT

WEDNESDAY

OCTOBER 6, 2021

SINGLE COPY \$1.00

NATION

Ex-Facebook employee tells Congress social media giant endangers users, democracy

SEE PAGE A6

your **daily briefing** ✓

Groundwater sustainability plan available for public comment

By David Wilson

dwilson@appealdemocrat.com

The Sutter Subbasin Groundwater Sustainability Plan Public Draft has been made available for public comment through Nov. 12.

Nine Groundwater Sustainability Agencies (GSAs) of Sutter Groundwater Subbasin have been preparing a groundwater sustainability plan (GSP) in response to the Sustainable Groundwater Management Act (SGMA). The plan is expected to

Please see, **GSP, A3**

Officials seeking input on proposed Feather River Parkway project

By David Wilson

dwilson@appealdemocrat.com

The Sutter County Resource Conservancy District is working with the National Parks Service to plan a new parkway along the Feather River from the 10th Street Bridge to Shanghai Bend.

In June, the conservancy district received a planning grant from the National Parks Services Rivers, Trails and Conservation Assistance program and conservancy district board member Michael Johnston said the project is "midway through the planning process." For the next two weeks an online survey will be available for residents to provide input about their thoughts on if they want the parkway and if it goes forward what they'd like to see added along the river.

The parkway would provide pedestrian, hiking, and biking trails along the Feather

Please see, **SURVEY, A3**

Fall festival planned to fund church restorations

By Lynzie Lowe

llowe@appealdemocrat.com

To raise money to continue restoring its 166-year-old historic church, St. Joseph Catholic Church will host its

Homeless man arrested for mall fire

Further investigation determined domestic confrontation led to blaze

By David Wilson

dwilson@appealdemocrat.com

The homeless man removed from the former Peach Tree Mall building fire in Linda on Saturday has had charges of arson, attempted murder, burglary, and criminal threats



Wright

added to his arrest for violation of probation after further investigation into the incident.

Thomas

Paul Wright, 32, was removed from the vacant building in the 6000 block of Lindhurst Avenue at around 5:30 a.m. Saturday and was booked into Yuba County Jail on a warrant for a violation of probation. After additional investigation, a victim came

forward to report that she had been in a domestic violence confrontation with Wright inside the old mall the morning of the fire. The confrontation escalated to Wright threatening to kill

Please see, **FIRE, A2**



Photo courtesy of Christopher Pedigo

The sixth annual Richard Sinnott Memorial Car Show was held Saturday at the Marysville Flea Market.

Car show celebrates flea market, raceway owner

'He loved cars and had been collecting since he was little'

By Jeff Larson

jl Larson@appealdemocrat.com

Misty Sinnott-Castleberry said the sixth annual Richard Sinnott Memorial Car Show was filled with some of

Richard Sinnott's favorite people on Saturday at the Marysville Flea Market.

The event is held on the first Saturday of October, she said, as a celebration for the long-time flea market and raceway

owner.

Sinnott died at 65 from a rare blood disorder that caused his lungs to shut down, said Sinnott-Castleberry.

In trying to find a way to honor her late father, Sinnott-

Castleberry and her husband, James Castleberry, came up with a car show because that was one of Sinnott's passions in life.

"He loved cars and had been collecting since he was little," Sinnott-Castleberry said. "My

Please see, **SHOW, A3**



Lynzie Lowe/Appeal-Democrat

Riders trekked through the back roads of Sutter and Colusa counties as they participated in the 10th annual 3F Century Bike Ride in 2019.

Colusa Lions Club to host

Sutter County Career Training Center brings opportunities

By Diana Vasquez

dvasquez@appealdemocrat.com

An expanded technical education career center will be brought to the region by Sutter County Superintendent of Schools (SCSOS).

The expansion comes via its newly acquired Cambridge Junior College campus that will now be called the Sutter County Career Training Center. SCSOS announced

SHOW / From A1

biggest regret is that we didn't do it when he was alive because he would think this is incredible." The event is always free to the public and is run by an entirely local staff. It features cars from multiple decades as well as raffle prizes and a full snack bar to help offset costs to host the show.

"The way it is free is the community comes together and donates all the raffle prizes," Sinnott-Castleberry said. "Then basically I put out all the money out of my own pocket to (run) it, then make the money back through the raffle prizes and snack bar."

Sinnott-Castleberry feels that her father

would be proud of what the family is doing in his honor. "I know my dad would have wanted it for free," Sinnott-Castleberry said. "He was born and raised here (and) always wanted to have a car show."

The flea market, which is currently owned by the Sinnott family trust, has been locally owned since 1992, Sinnott-Castleberry said. She has been an employee at the flea market since she was 12.

The Marysville Raceway, which Sinnott also owned, is currently leased out to a promoter to run the day-to-day operations, Sinnott-Castleberry said. "He (Richard Sinnott) was a big part of the community, he was a character,"

Sinnott-Castleberry said. "He had a ton of friends, all into cars."

Many were at the car show on Saturday celebrating Sinnott.

Larry Houk, of Olivehurst, is a four-time car show champion and owner of a 1989 GMC pickup. He said the car show gets bigger each year in part because of its namesake.

"It's celebrating a good dude," Houk said. Houk said he has only missed one of the six car shows.

Chris Giaammona, a neighbor to Sinnott-Castleberry and her husband, also is a frequent visitor to the car show each year. He and his family love seeing the "cars and the people."

CENTER / From A1

programs and students were transitioned to the new Sutter County Career Training Center. Approximately 90 students transitioned from Cambridge to the Sutter County Training Center and are continuing to complete the medical assisting career program.

"It was an easy transition since the college was already nationally accredited," said Tom Reusser, superintendent of SCSOS. "We are expanding career technical education opportunities for students in the community."

Under SCSOS's direction, the Sutter County Career Training Center will provide access to students for Pell Grants, CalGrants, veterans benefits, and other financial assistance programs administered by the U.S. Department of Education once SCSOS receives regulatory approval. The newly formed Sutter County Career Training Center will expand current career technical education programs that SCSOS already offers through the Sutter County One Stop and Sutter County Adult Education programs.

In addition, SCSOS is working on adding a cosmetology program for the spring of 2022.

"Student costs will remain about the same," said Reusser. "It may be much cheaper for students once they apply for and are eligible for financial aid. Tuition may even decrease in the long run because Cambridge Junior College was a for-profit institution, but we're a nonprofit organization. We're not here to make profit, but rather create opportunities for students."

Teachers and staff previously working at Cambridge Junior College had to reapply as new employees of SCSOS. Most did reapply, said Reusser. Teachers that were hired had to also apply for a California teaching credential.

Programs offered through SCSOS that will be expanded under the Sutter County Career Training Center are phlebotomy, LVN, dental assisting, home health aid, CNA and short-term certificate programs like welding, robotics and culinary arts. Reusser estimates Sutter County Career Training Center will serve approximately 400 students.

"This merger creates additional opportunities for students in the region seeking education and training that leads directly to employment," said Reusser.

SCSOS also provides its services to approximately 20,000 public school students through 12 district and nine charter schools. Reusser encouraged community members that may be interested in programs offered at the Sutter County Career Training Center to contact SCSOS directly at 530- 674-9199 or www.cambridge.edu.

GSP / From A1

be completed by the end of the year and adopted prior to the regulatory deadline of Jan. 31, 2022, according to a press release from the Sutter Subbasin.

The nine agencies include: the Sutter County Groundwater Sustainability Agency, the Butte Water District GSA, the Live Oak GSA, the Sutter Extension Water District GSA, the Sutter Community Services District GSA, the Yuba City GSA, the Reclamation District 70 GSA, the Reclamation District 1660 GSA, and the Reclamation District 1500 GSA.

"The Sutter Subbasin is generally in very good shape with respect to sustainable groundwater," Sutter County public information officer Chuck Smith said in an email. "The biggest concern

is protecting groundwater quality." SGMA passed in 2014 and was enacted in 2015 with the goal of ensuring the long-term sustainable management of the state's groundwater resources. The act requires agencies throughout California to meet certain requirements, including forming GSAs, developing GSPs and achieving sustainable conditions within 20 years. Those conditions are defined by six basin-specific sustainable management criteria, according to Smith.

The criteria regarding seawater intrusion does not apply to the Sutter Subbasin. The other five criteria are included in the GSP that establishes a representative monitoring network through which data has and will continue to be collected and compared to two sets of numerical criteria called

minimum thresholds (MT) and measurable objectives (MO).

At each monitored location, the MO defines where the Sutter Subbasin wants the groundwater level to be and the MT sets the levels at which significant and unreasonable undesirable impacts could occur.

"The preparation of the GSP is being funded by a combination of state grant funding and funding supplied by the nine GSAs in the subbasin and funding supplied by five other contributing partners," Smith said. "Funding for plan implementation is currently being determined."

After the public comment period, any comments will be logged and changes to the plan will be considered. The GSP will then be finalized and adopted individually by the

nine GSAs. Once adopted, the GSP will be submitted to the California Department of Water Resources (DWR) prior to Jan. 31, 2022. DWR will then post the document for a 75-day public review period. "DWR will also be required to review and approve the GSP during the two years that follow," Smith said. "Once the GSP has been submitted, the GSAs will begin implementing the plan."

A public workshop on the public draft GSP will be held on Oct. 19 from 4-6 p.m. To join the meeting, visit global.gotomeeting.com/join/214694605. You can also dial in at +1 (408) 650-3123 and use access code 214-694-605.

The draft plan is available to view at www.suttersubbasin.org and comments can be submitted to info@suttersubbasin.org.

FESTIVAL / From A1

rides, games including bingo, a dunk tank, a K-9 demonstration (pending emergencies) and more planned, according to Handy.

Raffles will also be held throughout the day, said Handy, and three grand prize winners will receive \$300, \$200 and \$100.

There will also be plenty to eat during the festivities, with food vendors serving up

polish sausages in honor of Polish pastor Michal Olszewski, barbecue tri-tip, pizza and the Catholic Daughter will be making candy. There will also be a beer garden area for adults.

The Knights of Columbus will hold a flag raising ceremony at 1:30 p.m., said Handy, and Pam Souza will be on hand to sing the national anthem.

Since it is the year of St. Joseph, Handy said the festivities will be dedicated to him.

According to Handy, St. Joseph himself will be attending the festival, joined by the Blessed Mother, baby Jesus and a shepherd. "It just keeps getting bigger and bigger each year," said Handy. "I am hoping people will come out again this year."

The festival will be held at Notre Dame School, 715 C St., Marysville, on Sunday from 9 a.m. to 5 p.m. Admission and parking are free.

For more information, call 742-6461.

SURVEY / From A1

River and would also restore natural habitat in the area and provide educational displays.

Once the survey is done, the plans for the project will be completed with the addition of the public's input. The next step would be securing grant funding to begin construction work. The current project is similar to a project that was scheduled to be completed in 2006 but did

not happen because of lack of funds. Johnston said in 2006 the project was projected to cost \$50,000. He said construction will cost considerably more than \$50,000 but said there are enough grants available that he is not worried about a lack of funding.

"It's just a dream come true," Johnston said of the project going forward.

He said the project will draw more tourism to Sutter County.

In addition, a parkway is in the works along the river in the Sacramento area, which could connect with the Sutter County parkway once both are completed.

"Go down and look at the river and enjoy," Johnston said. "See what you might want down there."

To access the survey, visit surveyMonkey.com/r/riverparkway or scan the QR code with your phone.



Scan for Feather River Parkway survey.

BIKE / From A1

a 100-mile century, a 100K metric century which is 68 miles or a 38-mile ride.

These routes pass through the towns of Meridian and Sutter, ride through the farmlands of the Sutter Bypass, cross the Tisdale Weir, ride along the scenic Sacramento River levee road and all the way around the Sutter Buttes for those attempting the 100-mile ride.

According to McGarth, in addition to the bike ride, organizers have added a cornhole tournament presented by DFT Cornhole, music/DJ and food trucks. Farmers Brewing and Colusa Tap

from Washington state, Idaho, and Southern California - which is kinda like another state," said McGarth. "The past couple of years we have had a group of eight riders come from the Riverside/San Bernardino area."

He hopes registration numbers continue to grow in the coming days.

"The numbers are down, as they are at other events like this," said McGarth. "The virus and concerns about social distancing are a primary cause of this. We take every precaution we can think of - masks required, individually packaged food items at the aid stations, hand sanitizers, requirement for

"We have had riders from age 10 to 80," said McGarth. "Because this is flat, and probably the flattest century in California, we attract a lot of first-time century riders. When we started, the majority of other rides were trying to outdo one another with how hard their ride was. This was off-putting to recreational riders who wanted a century on their list of accomplishments but couldn't handle all the climbing of the other events."

McGarth said his favorite part of the event is seeing all the riders out there having a good time.

"Seeing them at the end enjoying their accomplishment," said McGarth. "It makes me smile."

The 2021 Flat, Fast and Fun Century Bike Ride will be held Saturday. Those interested in participating can pre-register online at <http://3fcentury.com/index.php>. Registration will also be available at the event's start location, 901 Parkhill St. in Colusa, on Friday from 6-8 p.m. or on Saturday morning at 5:45 a.m.

Registration fees range from \$50-\$70, depending on the route.

The 3F Century Ride

began in May of 2009 as a fundraiser to raise money to purchase a new mat for the Colusa High School wrestling team.

McGarth, principal of Colusa High School at the time, had just started a new wrestling program and initiated the bike ride to pay back a loan he had taken out from the Colusa Redskins Athletic Foundation to cover the costs of the new wrestling mat.

The Lions Club partnered

with McGarth after the third year of the event and have hosted the event each year since with McGarth's help.

Proceeds from the race are used by the Lions Club to continue funding youth activity programs in the Colusa Unified School District and other activities with the community of Colusa.

For more information or to register online, visit www.3fcentury.com/index.php.

CA COVID-19 RENT RELIEF

Appendix 5-A
Well Logs Used to Develop Geologic Cross Sections

This page intentionally left blank.

Company: Butte Water District
Well Name: MW-1 06/20/07

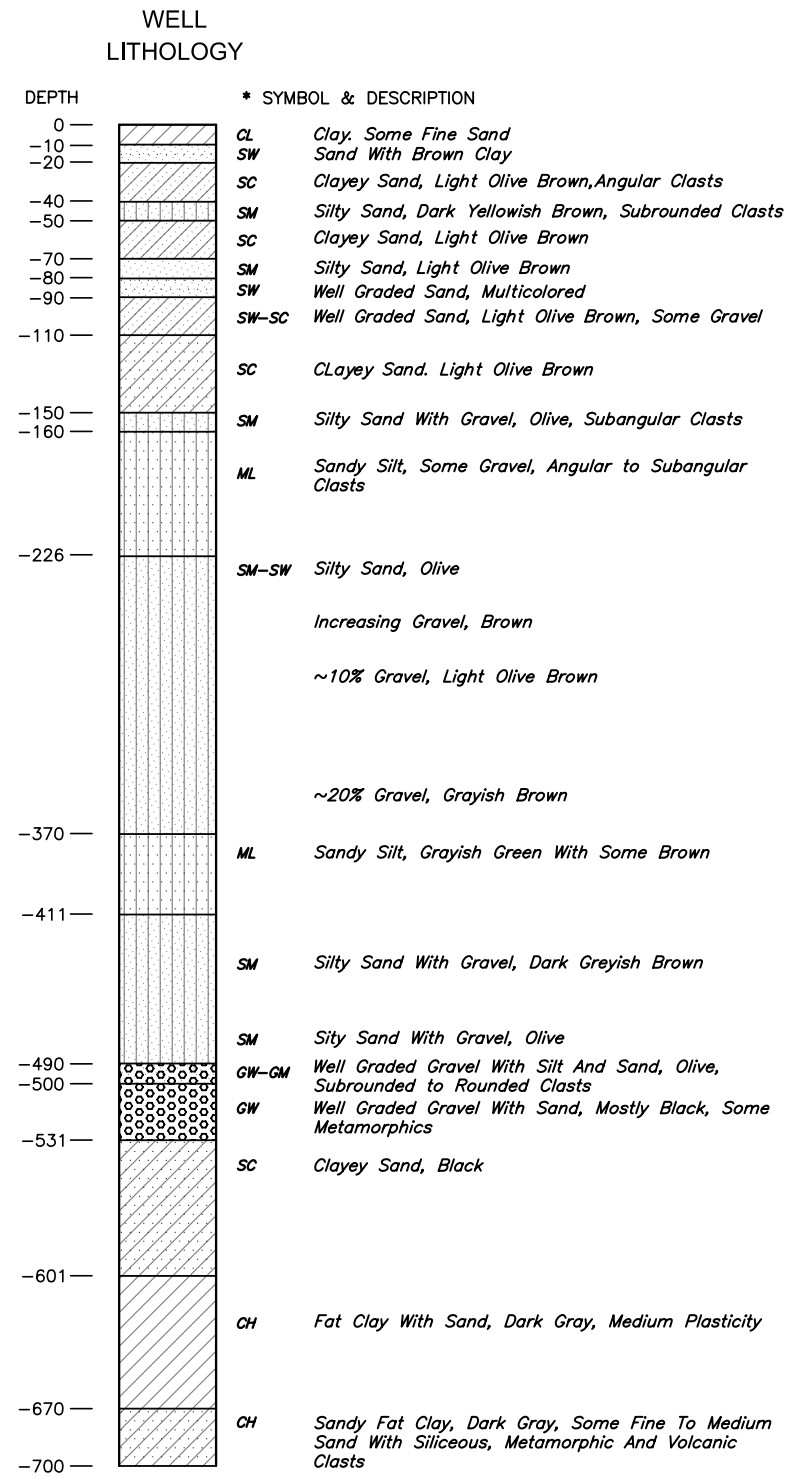

* Classification Symbols are based on the Unified Soil Classification System
** Lithologic Log Interpreted From Sediment Samples And Geophysical Log.

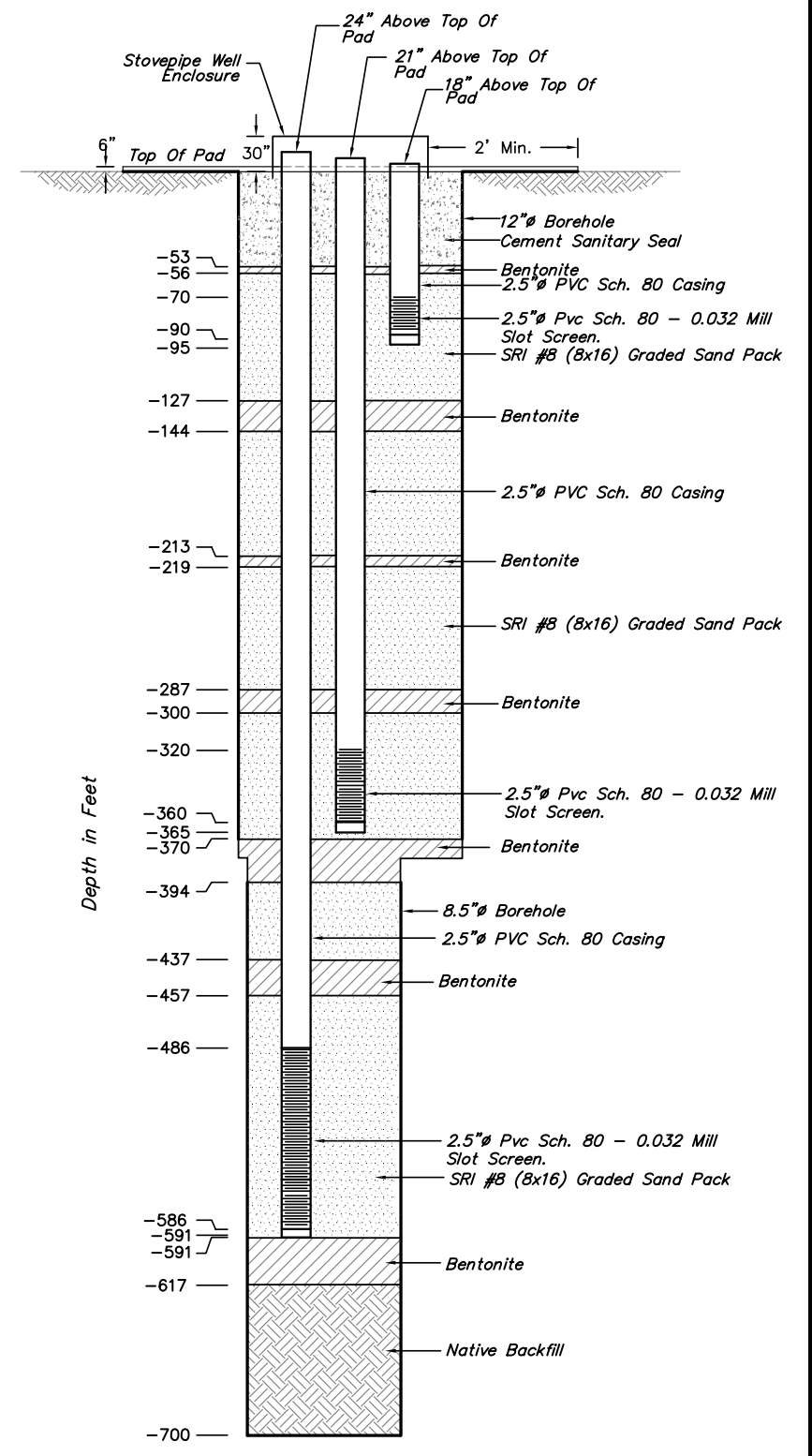
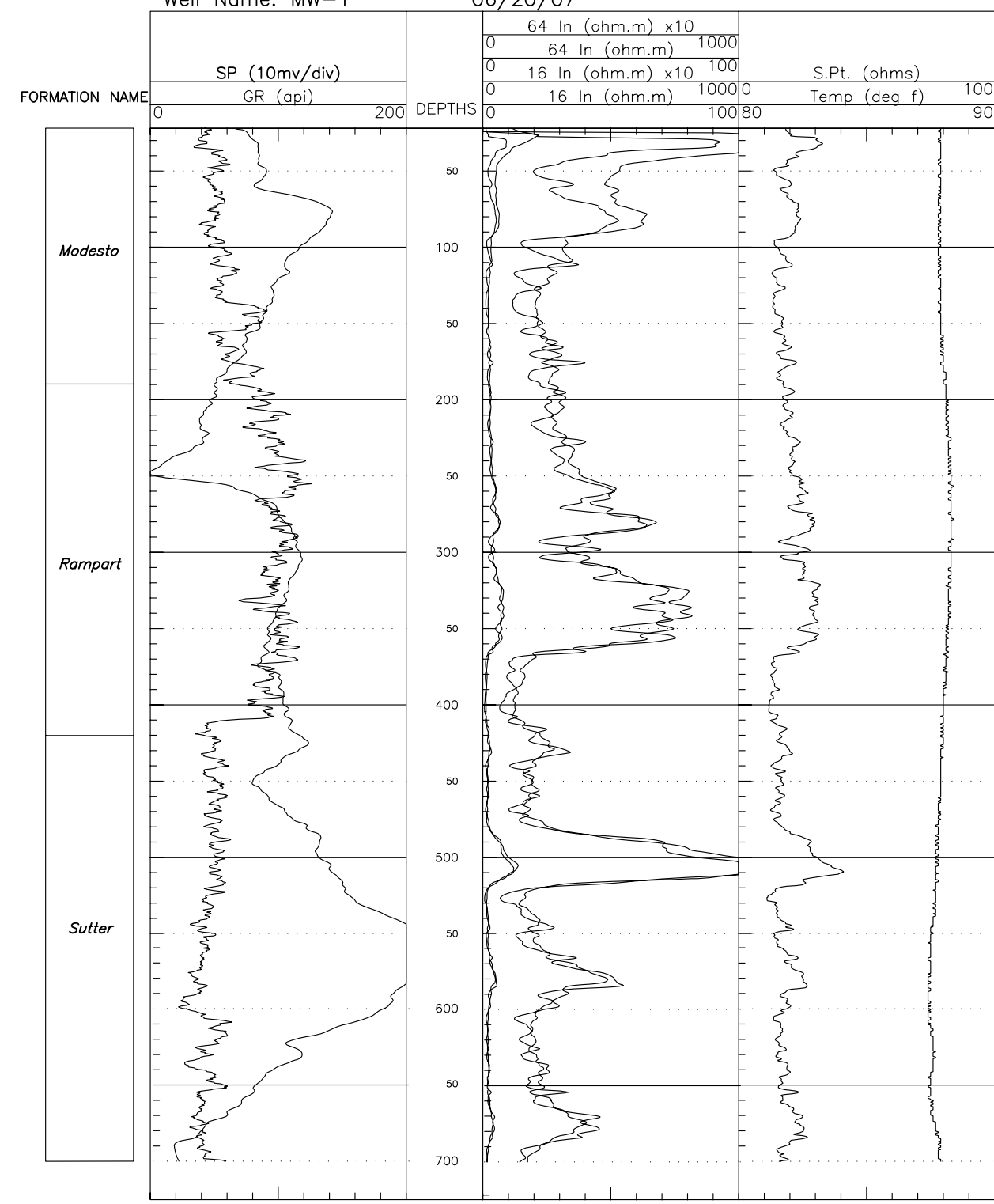

S:\Water Resources\Projects\050790\As-Built\MW-1\FIGURE 2 - MW-1 AS-BUILT.dwg C-01-MW-1 Mar 04, 2008 05:20:16 PM

DESIGNED _____	CHECKED _____			
DRAWN _____	APPROVED _____			
REV	DATE	DESCRIPTION	SUB	APP'D

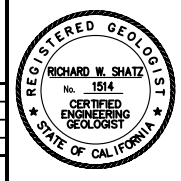

BUTTE WATER DISTRICT
BUTTE COUNTY

WARNING:
THIS BAR SHOULD MEASURE 1" OR DRAWING IS NOT TO SCALE



BUTTE WATER DISTRICT
CONJUNCTIVE USE PROGRAM

MW-1 AS-BUILT
CONSTRUCTION DETAILS

PROJ. NO: 050790	TASK NO. 10
ISSUE DATE November 2007	SUBMITTAL
A-3	

This page intentionally left blank.



5201 Woodmere Drive, Bakersfield, CA 93313-- www.welenco.com--(800) 445-9914
California Contractor's License No. 722373

ELECTRIC - GAMMA RAY - TEMPERATURE LOG

FILING NO.	COMPANY <u>Eaton Drilling</u>		
	WELL <u>DWR-SC-MW-2</u>		
	FIELD <u>Robbins</u>		
	STATE <u>California</u>	COUNTY <u>Sutter</u>	
	LOCATION: <u>Hwy 113 & Reclamation Road</u>		OTHER SERVICES: <u>Guard</u> <u>Borehole Geometry</u> <u>Dual Induction</u>
JOB NO. 12348	SEC: <u>23</u> TWP: <u>12N</u> RGE: <u>2E</u> LAT.: <u>38° 52' 33.3"</u> LONG.: <u>121° 42' 33.8"</u> MERIDIAN.: <u>Mt. Diablo</u>		

Permanent Datum: Ground Level, Elev. 78 Ft. Elev.: K.B. _____ Ft.
 Log Measured From: Ground Level, 0 Ft. Above Perm. Datum D.F. _____ Ft.
 Drilling Measured From: Ground Level G.L. 78 Ft.

Run	<u>One</u>						
Date	<u>Apr. 22, 2010</u>						
Depth-Driller	<u>1500</u>	Ft		Ft		Ft	Ft
Depth-Logger	<u>1498</u>	Ft		Ft		Ft	Ft
Top Logged Interval	<u>20</u>	Ft		Ft		Ft	Ft
Btm. Logged Interval	<u>1498</u>	Ft		Ft		Ft	Ft
Casing-Driller	<u>n/a</u>	In @	Ft	In @	Ft	In @	Ft
Casing-Logger	<u>n/a</u>	In @	Ft	In @	Ft	In @	Ft
Bit Size	<u>8.5</u>	In		In		In	In
Time On Bottom	<u>11:30</u>						
Type Fluid In Hole	<u>Bentonite</u>						
Density	Viscosity	<u>n/a</u>	<u>n/a</u>				
pH	Fluid Loss	<u>n/a</u>	<u>n/a</u> ml		ml		ml
Source of Sample	<u>Circ</u>						
Rm @ Measured Temp.	<u>6.7</u>	@	<u>82</u> °F	@	°F	@	°F
Rmf @ Measured Temp.	<u>5.4</u>	@	<u>75</u> °F	@	°F	@	°F
Rmc @ Measured Temp.	<u>n/a</u>	@	°F	@	°F	@	°F
Source Rmf	Rmc	<u>Meas</u>					
Rm @ BHT	<u>n/a</u>	@	°F	@	°F	@	°F
Time Since Circulation	<u>2 hr</u>	Hr		Hr		Hr	Hr
Max. Rec. Temp.	<u>79.8</u>	°F		°F		°F	°F
Van No.	Location	<u>LV-2</u>	<u>Sac</u>				
Recorded By	<u>M. F. Sharpless</u>						
Witnessed By	<u>S. Springhorn</u>						

Miscellaneous Information

A recreational GPS accurate to +/- 45 feet set for Datum NAD27 was used to calculate Latitude, Longitude & Elevation values. The Section, Township, and Range then determined using the TRS program (TRS accuracy is not guaranteed). The TRS program converts Latitude and Longitude to Section, Township, and Range. The NOTICE at the bottom of this heading also applies.

SP Calculations For Water Quality

LOG DEPTHS	S.P.	Rwe	Rw RANGE		E.C. RANGE		TDS RANGE	
			Ohmeters2/M		MSiemens		ppm	
			NaCl	NaHCo3	NaCl	NaHCo3	NaCl	NaHCo3
95 to 145 Feet	-30	2.0	1.9	2.2	5263	4545	2789	5000
205 to 220 Feet	-7	4.3	4.9	5.8	2041	1724	1082	1667
260 to 400 Feet	-3	4.9	5.8	6.8	1724	1471	914	1429
450 to 500 Feet	-2	5.1	6.1	7.2	1639	1389	869	1429
560 to 790 Feet	-2	5.1	6.1	7.2	1639	1389	869	1429
810 to 1000 Feet	-4	4.7	5.5	6.5	1818	1538	964	1429
1200 to 1250 Feet	-20	2.8	2.9	3.4	3448	2941	1828	3333
1250 to 1430 Feet	-38	1.6	1.5	1.8	6667	5556	3533	5000

Class I (Excellent to Good) Less than 700 ppm	Class II (Good to Injurious) 700-2000 ppm	Class III (Injurious to Poor) More than 2000 ppm
---	---	--

NOTICE

All interpretations are opinions based on inferences from electrical and other measurements and we do not guarantee the accuracy or correctness of any verbal or written interpretation, and we shall not, except in the case of gross or willful negligence on our part, be liable or responsible for any loss, costs, damages or expenses incurred or sustained by anyone resulting from any interpretation made by one of our officers, agents or employees. These interpretations are also subject to our General Terms and Conditions as set out in our current Price Schedule.
welenco, inc. April 22, 2010

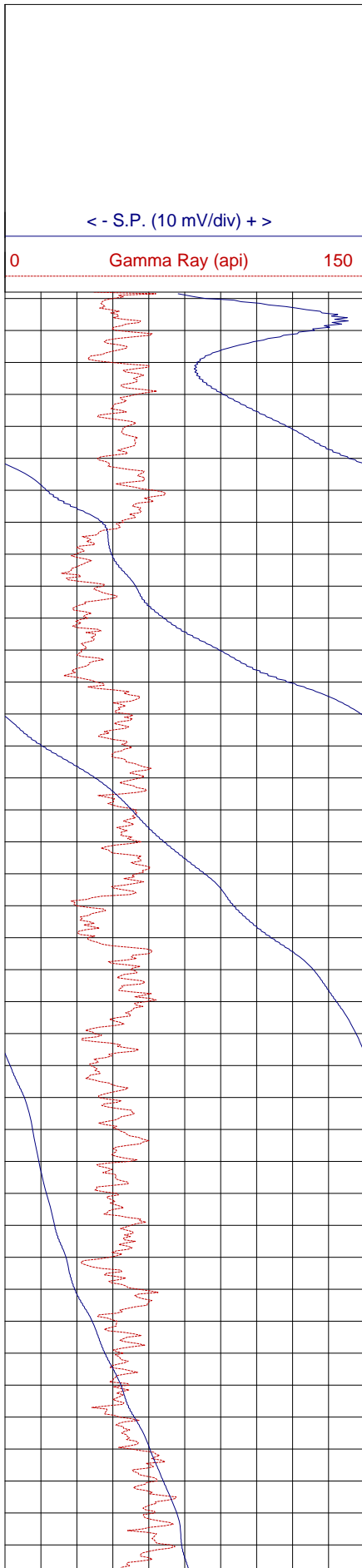

DEPTHS

2 in/100ft

ELECTRIC - GAMMA RAY - TEMPERATURE LOG

0	64 Inch Normal (ohmmeter ² /m)	100	0	Single Point (ohms)	50
0	16 Inch Normal (ohmmeter ² /m)	100	70	Temperature (°F)	80

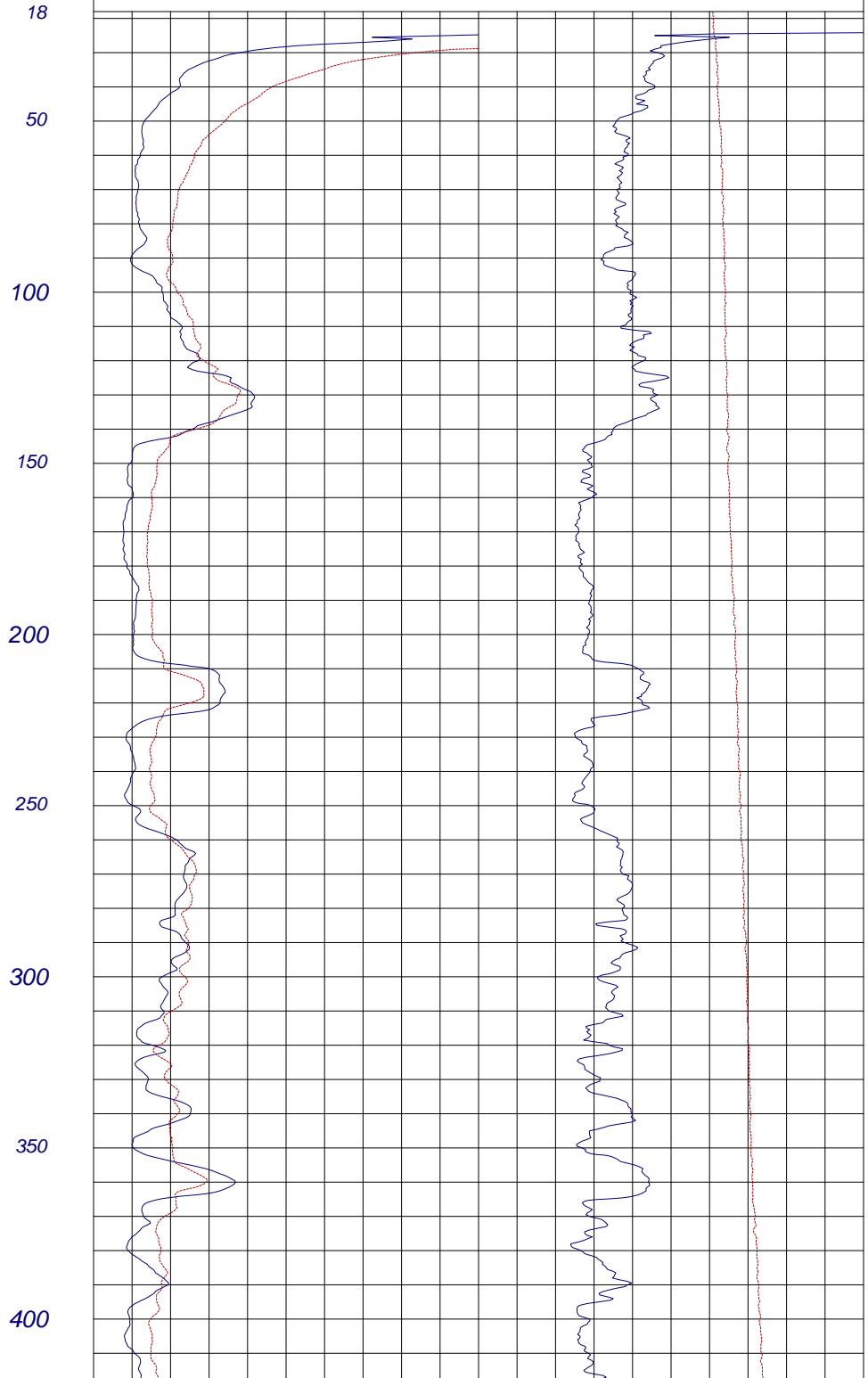

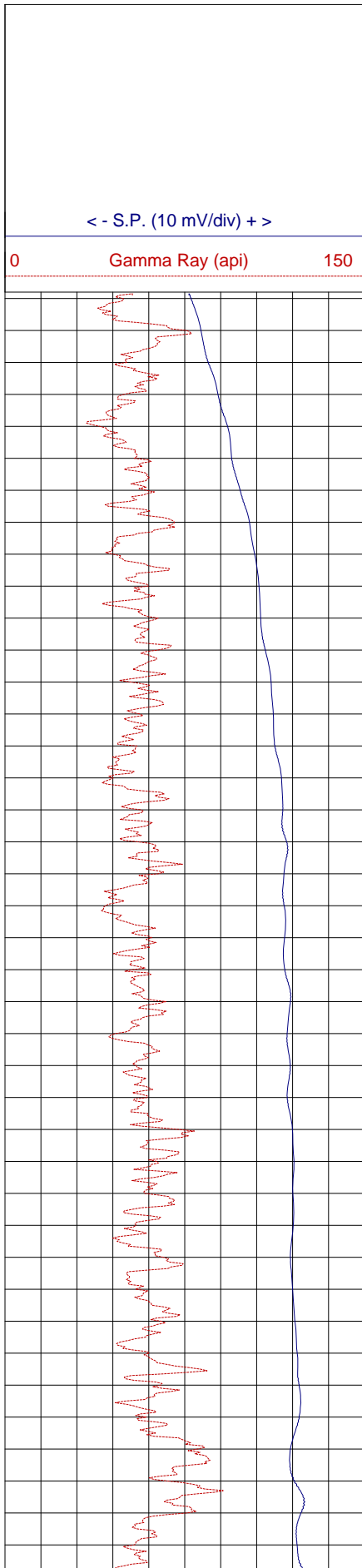

DEPTHS

2 in/100ft

ELECTRIC - GAMMA RAY - TEMPERATURE LOG

0	64 Inch Normal (ohmmeter ² /m)	100	0	Single Point (ohms)	50
0	16 Inch Normal (ohmmeter ² /m)	100	70	Temperature (°F)	80

450

500

550

600

650

700

750

800

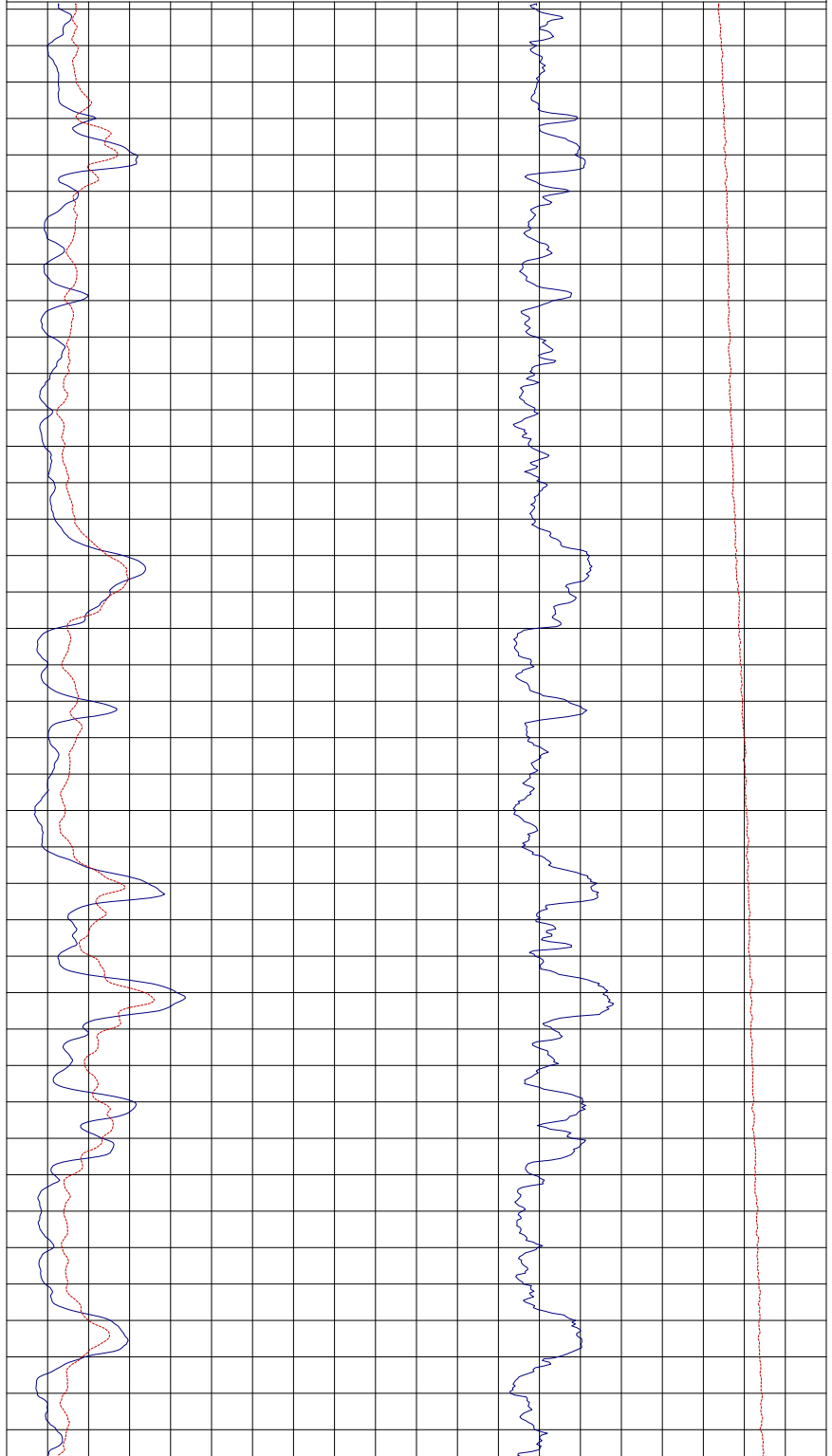

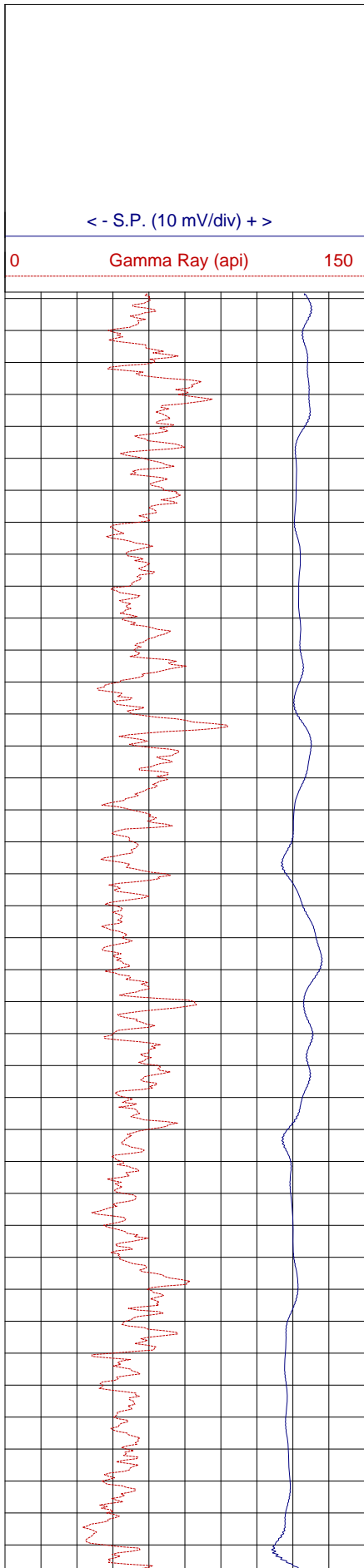

DEPTHS

2 in/100ft

ELECTRIC - GAMMA RAY - TEMPERATURE LOG

0	64 Inch Normal (ohmmeter ² /m)	100	0	Single Point (ohms)	50
0	16 Inch Normal (ohmmeter ² /m)	100	70	Temperature (°F)	80

850

900

950

1000

1050

1100

1150

1200

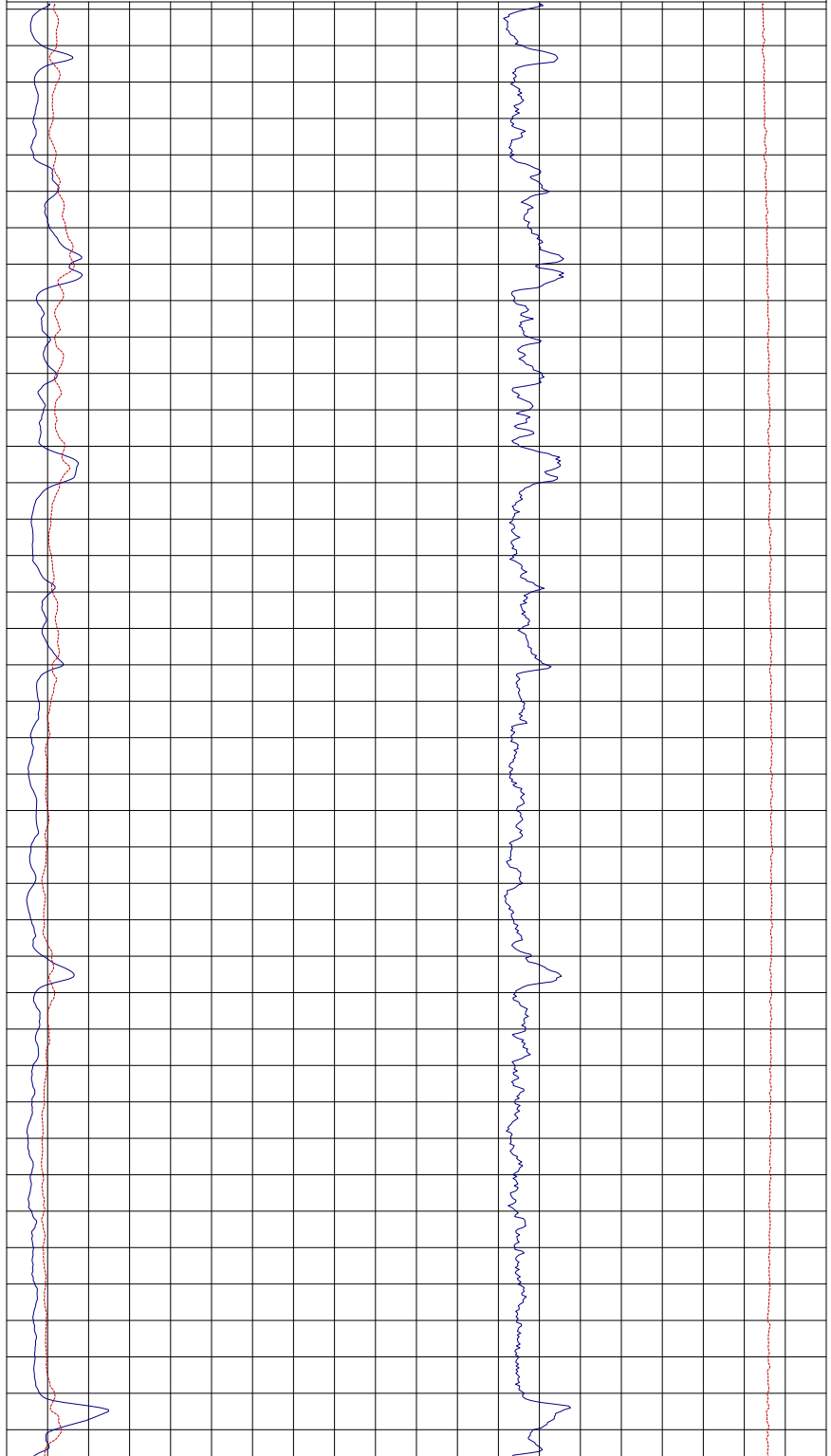

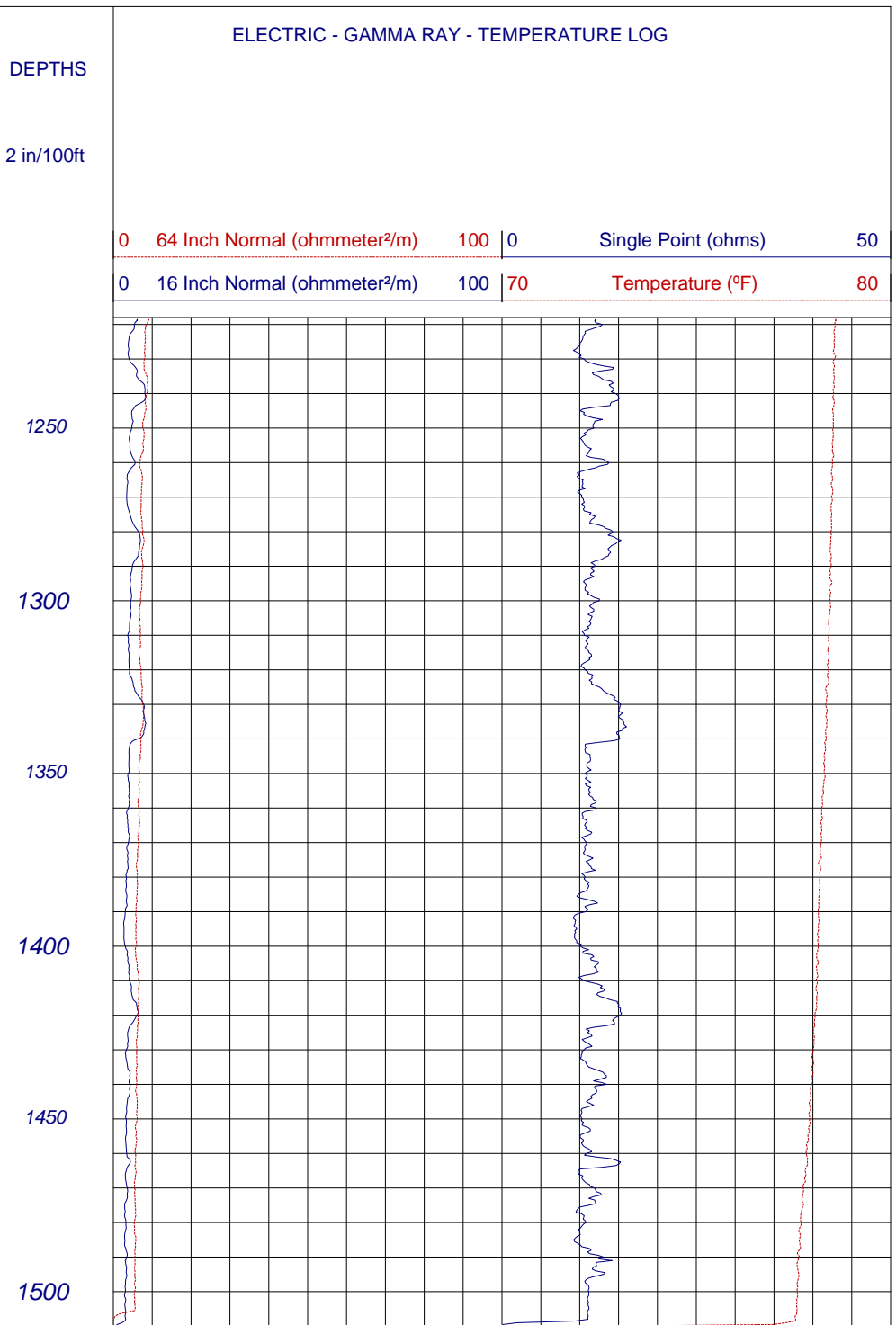
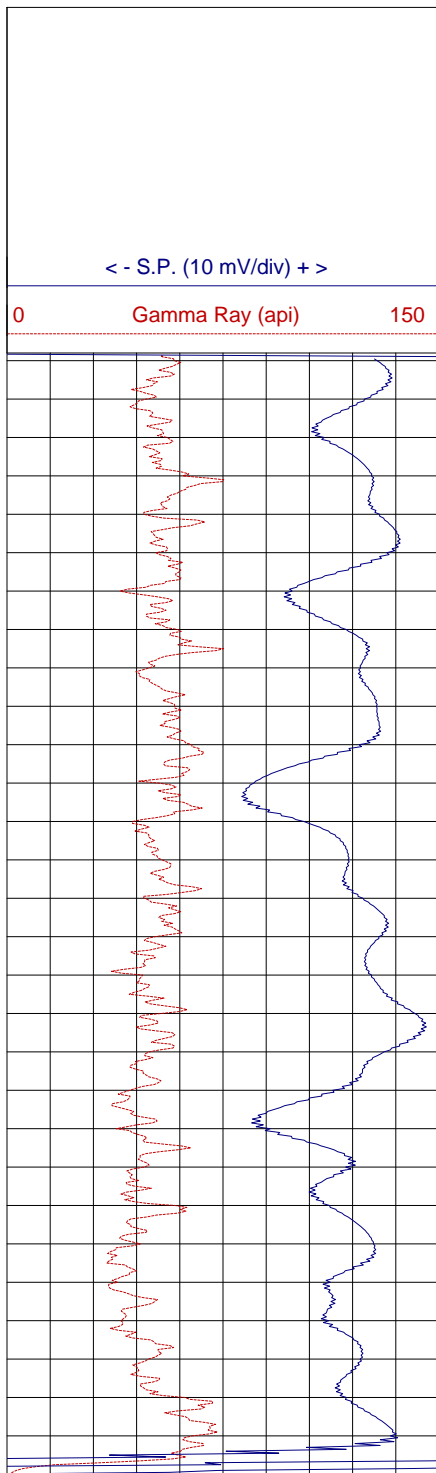

DWR
Sutter County MW-2A,B,C,D

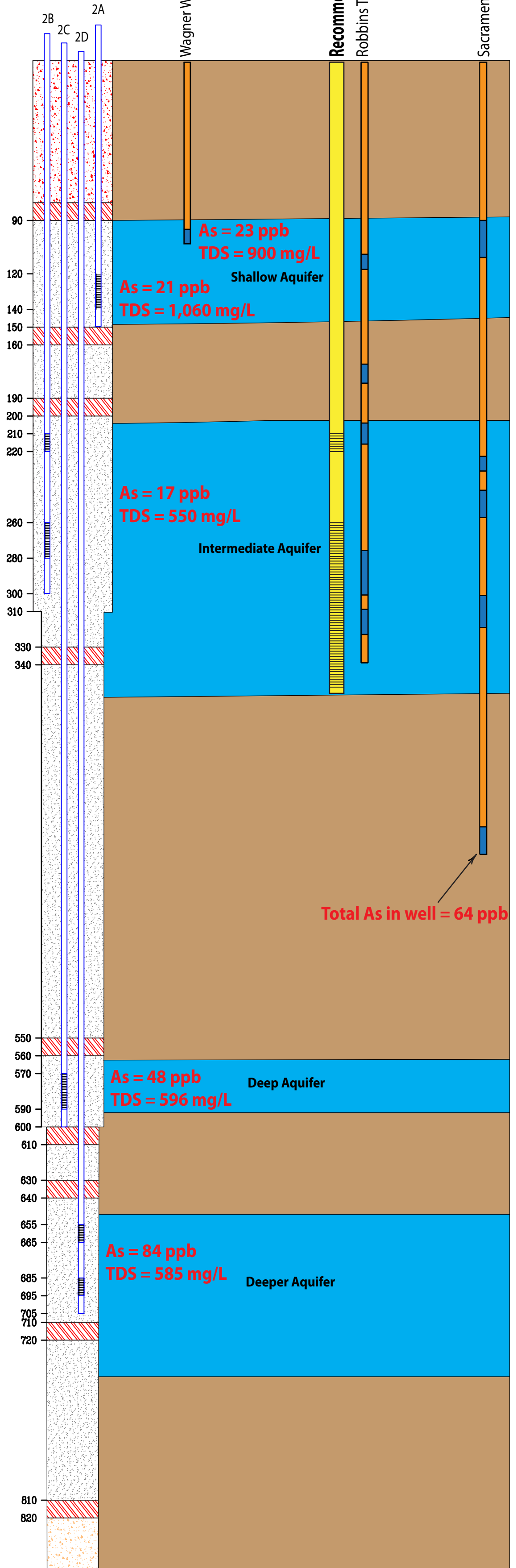

Legend			
Recommended Well		Well Screen	
Permeable Unit (as identified in Driller's Log)		Aquifer	
Non-permeable Unit (as identified in Driller's Log)		Aquatard	

This page intentionally left blank.

Owner's Well No. 7912

Date Work Began 11/8/05, Ended 11/17/05

Local Permit Agency SUTTER COUNTY HEALTH DEPT

Permit No. 05-0259 Permit Date 10/28/05

STATE OF CALIFORNIA
WELL COMPLETION REPORT

Refer to Instruction Pamphlet

No. **816295**

DWR USE ONLY — DO NOT FILL IN

15ND02ELL

STATE WELL NO./STATION NO.

LATITUDE LONGITUDE

APN/TRS/OTHER

ORIENTATION (✓)		DRILLING METHOD	DESCRIPTION
<input checked="" type="checkbox"/> VERTICAL — HORIZONTAL — ANGLE — (SPECIFY)		<input checked="" type="checkbox"/> REVERSE — FLUID WATER	Describe material, grain, size, color, etc.
DEPTH FROM SURFACE	Ft. to Ft.		
0	22		WELL GRADED SAND
22	70		CLAY WITH SANDY SILT
70	103		YELLOW BROWN CLAY
103	133		LIGHT YELLOW BROWN SANDY CLAY
133	158		RED BROWN SILT
158	175		RED POORLY GRADED SAND
175	198		BROWN SANDY SILT
198	250		GRAY POORLY GRADED SNAD WITH GRAVEL
250	260		BROWN WELL GRADED GRAVEL WITH SAND
260	445		GRAY CLAYEY SAND WITH GRAVEL
445	500		YELLOW BROWN SAND WITH GRAVEL
500	510		YELLOW BROWN SILTY SAND
510	570		YELLOW BROWN SAND WITH SILTSTONE CHIP
570	630		YELLOW BROWN CLAYEY SAND WITH SILTSTO
630	640		BROWN CLAY WITH SAND
640	650		BROWN CLAYEY SAND
650	665		RED BROWN SILT WITH SAND
665	700		RED GRAY SAND WITH GRAVEL
700	730		GREEN GRAY SILT WITH SAND AND SILTSTON
730	740		GREEN GRAY SAND WITH SILT AND GRAVEL
740	900		GREEN GRAY SANDY SILT WITH GRAVEL

WELL OWNER

Name **SUTTER EXTENTION WATER DIS**

Mailing Address **4525 FRANKLIN ROAD**
YUBA CITY CA 95993

CITY STATE ZIP

WELL LOCATION

Address **100' NO. OF BUTTE HOUSE RD & 1.05 MI W OF**

City **TOWNSHIP RD CA**

County **SUTTER**

APN Book **013** Page **240** Parcel **510**

Township **15 N** Range **2 E** Section **11**

Latitude _____

DEG. MIN. SEC. _____

LOCATION SKETCH

NORTH _____

WEST _____

SOUTH _____

Illustrate or Describe Distance of Well from Roads, Buildings, Fences, Rivers, etc. and attach a map. Use additional paper if necessary. PLEASE BE ACCURATE & COMPLETE.

ACTIVITY (✓)

NEW WELL

MODIFICATION/REPAIR

— Deepen

— Other (Specify)

— DESTROY (Describe Procedures and Materials Under "GEOLOGIC LOG")

PLANNED USES (✓)

WATER SUPPLY

— Domestic — Public

— Irrigation — Industrial

MONITORING —

TEST WELL _____

CATHODIC PROTECTION _____

HEAT EXCHANGE _____

DIRECT PUSH _____

INJECTION _____

VAPOR EXTRACTION _____

SPARGING _____

REMEDICATION _____

OTHER (SPECIFY) _____

WATER LEVEL & YIELD OF COMPLETED WELL

DEPTH TO FIRST WATER _____ (Ft.) BELOW SURFACE

DEPTH OF STATIC WATER LEVEL _____ (Ft.) & DATE MEASURED _____

ESTIMATED YIELD * _____ (GPM) & TEST TYPE _____

TEST LENGTH _____ (Hrs.) TOTAL DRAWDOWN _____ (Ft.)

May not be representative of a well's long-term yield.

DEPTH FROM SURFACE	BORE-HOLE DIA. (Inches)	CASING (S)							
		TYPE (✓)				MATERIAL / GRADE	INTERNAL DIAMETER (Inches)	GAUGE OR WALL THICKNESS	SLOT SIZE IF ANY (Inches)
Ft. to Ft.		BLANK	SCREEN	CON-DUCTOR	FILL PIPE				
ZONE 1	1								
0	148	14	✓			PVC	2.5	SCH 80	
148	168	14		✓		PVC	2.5	SCH 80	.030
168	173	14	✓			PVC	2.5	SCH 80	
ZONE 2	2								
0	240	14	✓			PVC	2.5	SCH 80	

DEPTH FROM SURFACE	ANNULAR MATERIAL			
	TYPE			
Ft. to Ft.	CE-MENT (✓)	BEN-TONITE (✓)	FILL (✓)	FILTER PACK (TYPE/SIZE)
0	127	✓		SAND SLURRY
127	139		✓	BENTONITE C
139	174		✓	SRI#8 SAND
174	190		✓	BENTONITE C
190	221		✓	SRI#8 SAND
221	230		✓	BENTONITE C

ATTACHMENTS (✓)

— Geologic Log

— Well Construction Diagram

— Geophysical Log(s)

— Soil/Water Chemical Analysis

— Other _____

ATTACH ADDITIONAL INFORMATION, IF IT EXISTS.

CERTIFICATION STATEMENT

I, the undersigned, certify that this report is complete and accurate to the best of my knowledge and belief.

NAME **EATON DRILLING CO**
(PERSON, FIRM, OR CORPORATION) (TYPED OR PRINTED)

ADDRESS **20 WEST KENTUCKY AVE** CITY **WOODLAND** STATE **CA** ZIP **95695**

Signed *Mark Damin* DATE SIGNED **01/24/06** C57 A HIC - 133783
WELL DRILLER/AUTHORIZED REPRESENTATIVE DATE SIGNED C-57 LICENSE NUMBER

STATE OF CALIFORNIA
WELL COMPLETION REPORT

Refer to Instruction Pamphlet

No. **816295**

pg 2

DWR USE ONLY - DO NOT FILL IN

15202871

STATE WELL NO./STATION NO.

LATITUDE LONGITUDE

APN/TRS/OTHER

Owner's Well No. 7912

Date Work Began 11/8/05, Ended 11/17/05

Local Permit Agency SUTTER COUNTY HEALTH DEPT

Permit No. 05-0259 Permit Date 10/28/05

GEOLOGIC LOG

ORIENTATION (✓)		DRILLING METHOD	FLUID WATER	DESCRIPTION
<input checked="" type="checkbox"/> VERTICAL <input type="checkbox"/> HORIZONTAL <input type="checkbox"/> ANGLE _____ (SPECIFY)		REVERSE		Describe material, grain, size, color, etc.
DEPTH FROM SURFACE	Ft. to Ft.			
0	22	WELL GRADED SAND		
22	70	CLAY WITH SANDY SILT		
70	103	YELLOW BROWN CLAY		
103	133	LIGHT YELLOW BROWN SANDY CLAY		
133	158	RED BROWN SILT		
158	175	RED POORLY GRADED SAND		
175	198	BROWN SANDY SILT		
198	250	GRAY POORLY GRADED SAND WITH GRAVEL		
250	260	BROWN WELL GRADED GRAVEL WITH SAND		
260	445	GRAY CLAYEY SAND WITH GRAVEL		
445	500	YELLOW BROWN SAND WITH GRAVEL		
500	510	YELLOW BROWN SILTY SAND		
510	570	YELLOW BROWN SAND WITH SILTSTONE CHIP		
570	630	YELLOW BROWN CLAYEY SAND WITH SILTSTONE		
630	640	BROWN CLAY WITH SAND		
640	650	BROWN CLAYEY SAND		
650	665	RED BROWN SILT WITH SAND		
665	700	RED GRAY SAND WITH GRAVEL		
700	730	GREEN GRAY SILT WITH SAND AND SILTSTONE		
730	740	GREEN GRAY SAND WITH SILT AND GRAVEL		
740	900	GREEN GRAY SANDY SILT WITH GRAVEL		

WELL OWNER

Name SUTTER EXTENTION WATER DIS

Mailing Address 4525 FRANKLIN ROAD
YUBA CITY CA 95993

CITY STATE ZIP

WELL LOCATION

Address 100' NOF BUTTE HOUSE RD & 1.05 MI W OF
City TOWNSHIP RD CA
County SUTTER

APN Book 013 Page 240 Parcel 510
Township 15 N Range 2 E Section 11

Latitude _____

LOCATION SKETCH

NORTH

WEST

EAST

SOUTH

Illustrate or Describe Distance of Well from Roads, Buildings, Fences, Rivers, etc. and attach a map. Use additional paper if necessary. PLEASE BE ACCURATE & COMPLETE.

ACTIVITY (✓)

NEW WELL

MODIFICATION/REPAIR
 Deepen
 Other (Specify) _____

DESTROY (Describe Procedures and Materials Under "GEOLOGIC LOG")

PLANNED USES (✓)

WATER SUPPLY
 Domestic Public
 Irrigation Industrial

MONITORING

TEST WELL _____

CATHODIC PROTECTION _____

HEAT EXCHANGE _____

DIRECT PUSH _____

INJECTION _____

VAPOR EXTRACTION _____

SPARGING _____

REMEDICATION _____

OTHER (SPECIFY) _____

WATER LEVEL & YIELD OF COMPLETED WELL

DEPTH TO FIRST WATER _____ (Ft.) BELOW SURFACE

DEPTH OF STATIC WATER LEVEL _____ (Ft.) & DATE MEASURED _____

ESTIMATED YIELD * _____ (GPM) & TEST TYPE _____

TEST LENGTH _____ (Hrs.) TOTAL DRAWDOWN _____ (Ft.)

May not be representative of a well's long-term yield.

DEPTH FROM SURFACE	BORE-HOLE DIA. (Inches)	CASING (S)							
		TYPE (✓)	MATERIAL / GRADE	INTERNAL DIAMETER (Inches)	GAUGE OR WALL THICKNESS	SLOT SIZE IF ANY (Inches)			
Ft. to Ft.		BLANK	SCREEN	CON-DUCTOR	FILL PIPE				
240	260	14	✓			PVC	2.5	SCH 80	.030
260	265	14	✓			PVC	2.5	SCH 80	
ZONE 3									
0	524	14/8-5/8	✓			PVC	2.5	SCH 80	
524	554	8-8/5	✓			PVC	2.5	SCH 80	.030
554	559	8-5/8	✓			PVC	2.5	SCH 80	

DEPTH FROM SURFACE	ANNULAR MATERIAL				
	TYPE	CE-MENT (✓)	BEN-TONITE (✓)	FILL (✓)	
Ft. to Ft.				FILTER PACK (TYPE/SIZE)	
230	270			✓	SR#8 SAND
270	281		✓		BENTONITE C
281	493			✓	SR#8 SAND
493	518		✓		BENTONITE C
518	566			✓	SR#8 SAND
566	581		✓		BENTONITE C

ATTACHMENTS (✓)

Geologic Log

Well Construction Diagram

Geophysical Log(s)

Soil/Water Chemical Analysis

Other _____

ATTACH ADDITIONAL INFORMATION, IF IT EXISTS.

CERTIFICATION STATEMENT

I, the undersigned, certify that this report is complete and accurate to the best of my knowledge and belief.

NAME EATON DRILLING CO
(PERSON, FIRM, OR CORPORATION) (TYPED OR PRINTED)

ADDRESS 20 WEST KENTUCKY AVE CITY WOODLAND STATE CA ZIP 95695

Signed Mark Dainoff DATE SIGNED 01/24/08 C-67 LICENSE NUMBER C57 A HIC - 133783

WELL DRILLER/AUTHORIZED REPRESENTATIVE DATE SIGNED C-67 LICENSE NUMBER

Owner's Well No. 7912

Date Work Began 11/8/05, Ended 11/17/05

Local Permit Agency SUTTER COUNTY HEALTH DEPT

Permit No. 05-0259 Permit Date 10/28/05

STATE OF CALIFORNIA
WELL COMPLETION REPORT

Refer to Instruction Pamphlet

No. **816295**

pg. 3

DWR USE ONLY - DO NOT FILL IN

15 N 026 17

STATE WELL NO./STATION NO.

LATITUDE LONGITUDE

APN/TRS/OTHER

GEOLOGIC LOG

ORIENTATION (✓)		DRILLING METHOD	REVERSE	FLUID	WATER
DEPTH FROM SURFACE		DESCRIPTION			
Ft.	to Ft.	Describe material, grain, size, color, etc.			
0	22	WELL GRADED SAND			
22	70	CLAY WITH SANDY SILT			
70	103	YELLOW BROWN CLAY			
103	133	LIGHT YELLOW BROWN SANDY CLAY			
133	158	RED BROWN SILT			
158	175	RED POORLY GRADED SAND			
175	198	BROWN SANDY SILT			
198	250	GRAY POORLY GRADED SAND WITH GRAVEL			
250	260	BROWN WELL GRADED GRAVEL WITH SAND			
260	445	GRAY CLAYEY SAND WITH GRAVEL			
445	500	YELLOW BROWN SAND WITH GRAVEL			
500	510	YELLOW BROWN SILTY SAND			
510	570	YELLOW BROWN SAND WITH SILTSTONE CHIP			
570	630	YELLOW BROWN CLAYEY SAND WITH SILTSTO			
630	640	BROWN CLAY WITH SAND			
640	650	BROWN CLAYEY SAND			
650	665	RED BROWN SILT WITH SAND			
665	700	RED GRAY SAND WITH GRAVEL			
700	730	GREEN GRAY SILT WITH SAND AND SILTSTON			
730	740	GREEN GRAY SAND WITH SILT AND GRAVEL			
740	900	GREEN GRAY SANDY SILT WITH GRAVEL			

WELL OWNER

Name SUTTER EXTENTION WATER DIS

Mailing Address 4525 FRANKLIN ROAD
YUBA CITY CA 95993

CITY STATE ZIP

WELL LOCATION

Address 100' NOF BUTTE HOUSE RD & 1.05 MI W OF

City TOWNSHIP RD CA

County SUTTER

APN Book 013 Page 240 Parcel 510

Township 15 N Range 2 E Section 11

Latitude _____

LOCATION SKETCH

NORTH

WEST EAST

SOUTH

Illustrate or Describe Distance of Well from Roads, Buildings, Fences, Rivers, etc. and attach a map. Use additional paper if necessary. PLEASE BE ACCURATE & COMPLETE.

ACTIVITY (✓)

NEW WELL

MODIFICATION/REPAIR

— Deepen

— Other (Specify)

— DESTROY (Describe Procedures and Materials Under "GEOLOGIC LOG")

PLANNED USES (✓)

WATER SUPPLY

— Domestic — Public

— Irrigation — Industrial

MONITORING —

TEST WELL —

CATHODIC PROTECTION —

HEAT EXCHANGE —

DIRECT PUSH —

INJECTION —

VAPOR STRAPPING —

SPARGING —

REMEDICATION —

OTHER (SPECIFY) —

WATER LEVEL & YIELD OF COMPLETED WELL

DEPTH TO FIRST WATER _____ (Ft.) BELOW SURFACE

DEPTH OF STATIC WATER LEVEL _____ (Ft.) & DATE MEASURED _____

ESTIMATED YIELD _____ (GPM) & TEST TYPE _____

TEST LENGTH _____ (Hrs.) TOTAL DRAWDOWN _____ (Ft.)

May not be representative of a well's long-term yield.

DEPTH FROM SURFACE	BORE-HOLE DIA. (Inches)	CASING (S)					
		TYPE (✓)	MATERIAL / GRADE	INTERNAL DIAMETER (Inches)	GAUGE OR WALL THICKNESS	SLOT SIZE IF ANY (Inches)	
Ft.	to Ft.	BLANK	SCREEN	CON-DUCTOR	FILL PIPE		
ZONE 1							
0	148	14	✓			PVC	2.5 SCH 80
148	168	14	✓			PVC	2.5 SCH 80 .030
168	173	14	✓			PVC	2.5 SCH 80
ZONE 2							
0	240	14	✓			PVC	2.5 SCH 80

DEPTH FROM SURFACE	ANNULAR MATERIAL			
	CE-MENT (✓)	BEN-TONITE (✓)	FILL (✓)	FILTER PACK (TYPE/SIZE)
Ft.	to Ft.			
581	605			SR#8 SAND
605	624		✓	BENTONITE C
624	640		✓	SR#8 SAND

ATTACHMENTS (✓)

— Geologic Log

— Well Construction Diagram

— Geophysical Log(s)

— Soil/Water Chemical Analysis

— Other _____

ATTACH ADDITIONAL INFORMATION, IF IT EXISTS.

CERTIFICATION STATEMENT

I, the undersigned, certify that this report is complete and accurate to the best of my knowledge and belief.

NAME EATON DRILLING CO
(PERSON, FIRM, OR CORPORATION) (TYPED OR PRINTED)

20 WEST KENTUCKY AVE WOODLAND CA 95695
ADDRESS CITY STATE ZIP

Signed Mark Davison DATE SIGNED 01/24/06
WELL DRILLER/AUTHORIZED REPRESENTATIVE

C57 A HIC - 133783
C-57 LICENSE NUMBER

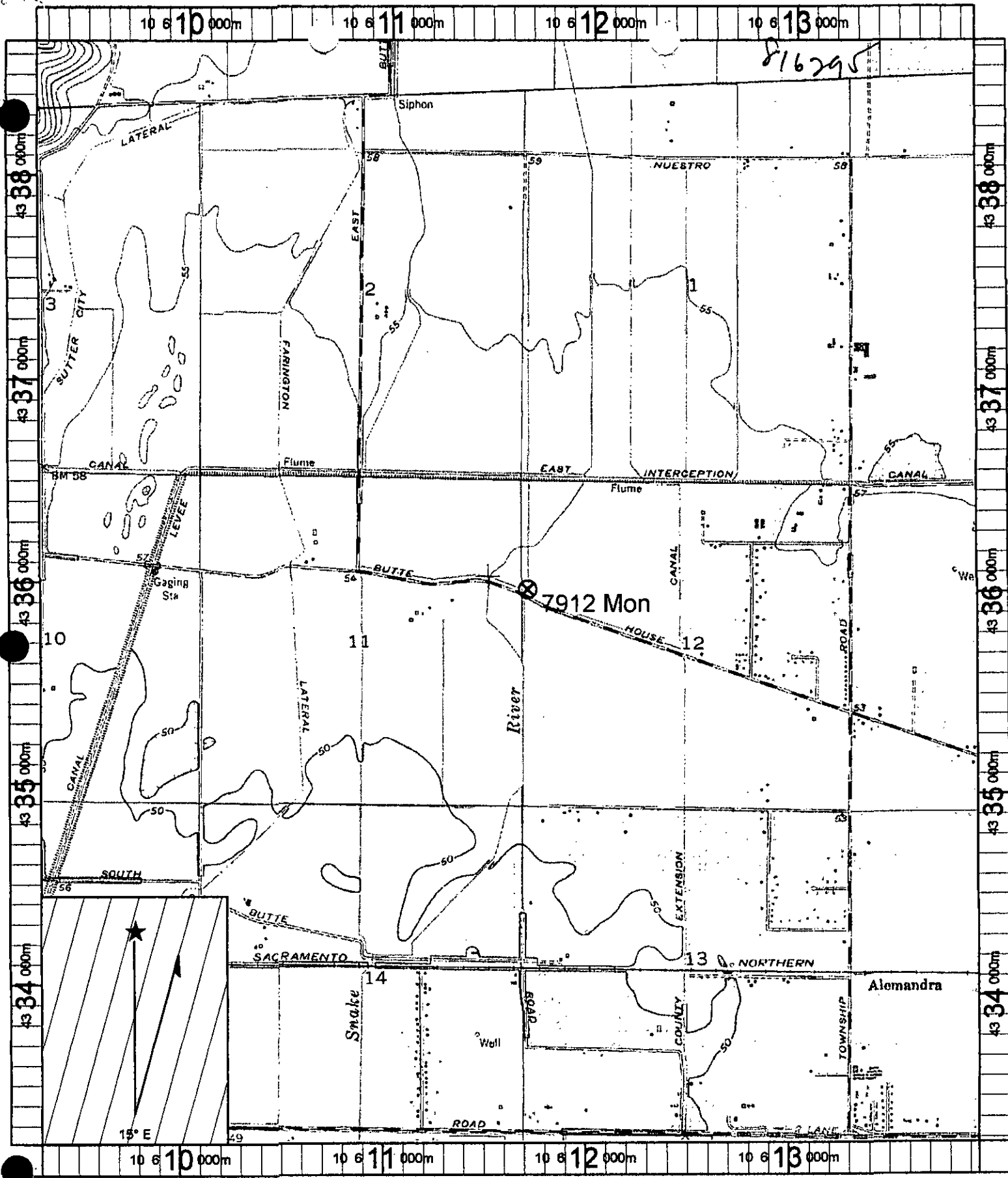

Name: SUTTER
 Date: 10/28/2005
 Scale: 1 inch equals 2000 feet

Caption: Sutter Extension Water District - Job# 7812 Mon
 APN: 013-240-510
 T15N R2E s12

STATE OF CALIFORNIA
WELL COMPLETION REPORT
Refer to Instruction Pamphlet

DWR USE ONLY — DO NOT FILL IN
15 NOV 2004
STATE WELL NO / STATION NO.
LATTITUDE LONGITUDE
APN/TRS/OTHER

Owner's Well No. 7913

No. **E036360**

Date Work Began 1/27/06, Ended 2/7/06

Local Permit Agency SUTTER COUNTY HEALTH DEPT

Permit No. 05-0260 Permit Date 10/28/05

GEOLOGIC LOG

ORIENTATION (✓) <input checked="" type="checkbox"/> VERTICAL <input type="checkbox"/> HORIZONTAL <input type="checkbox"/> ANGLE (SPECIFY)		DRILLING METHOD ROTARY	FLUID MUD
DEPTH FROM SURFACE Ft. to Ft.		DESCRIPTION Describe material, grain, size, color, etc.	
0	20	TOP SOIL AND BROWN CLAY WITH SAND	
20	55	YELLOW BROWN CLAY WITH COARSE SAND	
55	100	SAND AND GRAVEL	
100	160	LARGE GRAVEL WITH SANDY YELLOW CLAY	
160	300	YELLOW BROWN CLAY WITH SAND AND GRAV	
300	360	SAND AND GRAVEL WITH YELLOW BROWN CL	
360	650	SAND AND SMALL GRAVEL WITH YELLOW BROWN CLAY	
650	670	SAND AND SMALL GRAVEL WITH RED BROWN CLAY	
670	700	BLACK COARSE SAND	

WELL OWNER

Name **SUTTER EXTENTION WATER DIS**
Mailing Address **4525 FRANKLIN ROAD**
YUBA CITY CA **95993**
CITY STATE ZIP

WELL LOCATION

Address **300' NOF FRANKLIN RD & .52 MI WOF TOWNSHI**
City **RD CA**
County **SUTTER**
APN Book **013** Page **280** Parcel **054**
Township **15 N** Range **2 E** Section **24**
Latitude _____

LOCATION SKETCH
NORTH
WEST EAST
SOUTH
Illustrate or Describe Distance of Well from Roads, Buildings, Fences, Rivers, etc. and attach a map. Use additional paper if necessary. PLEASE BE ACCURATE & COMPLETE.

ACTIVITY (✓)
 NEW WELL
MODIFICATION/REPAIR
— Deepen
— Other (Specify)
— DESTROY (Describe Procedures and Materials Under "GEOLOGIC LOG")

PLANNED USES (✓)
WATER SUPPLY
— Domestic — Public
— Irrigation — Industrial
MONITORING —
TEST WELL —
CATHODIC PROTECTION —
HEAT EXCHANGE —
DIRECT PUSH —
INJECTION —
VAPOR EXTRACTION —
SPARGING —
REMEDICATION —
OTHER (SPECIFY) —

WATER LEVEL & YIELD OF COMPLETED WELL

DEPTH TO FIRST WATER _____ (Ft.) BELOW SURFACE
DEPTH OF STATIC WATER LEVEL _____ (Ft.) & DATE MEASURED _____
ESTIMATED YIELD * _____ (GPM) & TEST TYPE _____
TEST LENGTH _____ (Hrs.) TOTAL DRAWDOWN _____ (Ft.)
May not be representative of a well's long-term yield.

DEPTH FROM SURFACE Ft. to Ft.	BORE-HOLE DIA. (Inches)	CASING (S)						
		TYPE (✓)		MATERIAL / GRADE	INTERNAL DIAMETER (Inches)	GAUGE OR WALL THICKNESS	SLOT SIZE IF ANY (Inches)	
BLANK	SCREEN	CON-DUCTOR	FILL PIPE					
ZONE 1								
0	204	14	✓		PVC	2.5	SCH 80	
204	244	14		✓	PVC	2.5	SCH 80	.030
244	254	14	✓		PVC	2.5	SCH 80	
ZONE 2								
0	354	14	✓		PVC	2.5	SCH 80	

DEPTH FROM SURFACE Ft. to Ft.	ANNULAR MATERIAL TYPE			
	CE-MENT (✓)	BEN-TONITE (✓)	FILL (✓)	FILTER PACK (TYPE/SIZE)
0	178	✓		SAND SLURRY
178	192		✓	BENTONITE C.
192	276		✓	SRI#8 SAND
276	290		✓	BENTONITE C.
290	318		✓	SRI#8 SAND
318	330		✓	BENTONITE C.

ATTACHMENTS (✓)

- Geologic Log
- Well Construction Diagram
- Geophysical Log(s)
- Soil/Water Chemical Analysis
- Other

ATTACH ADDITIONAL INFORMATION, IF IT EXISTS.

CERTIFICATION STATEMENT

I, the undersigned, certify that this report is complete and accurate to the best of my knowledge and belief.

NAME **EATON DRILLING CO**
(PERSON, FIRM, OR CORPORATION) (TYPED OR PRINTED)
ADDRESS **20 WEST KENTUCKY AVE** CITY **WOODLAND** STATE **CA** ZIP **95695**
Signed *Mark Davis* DATE SIGNED **02/23/06** C57 A HIC - 133783
WELL DRILLER/AUTHORIZED REPRESENTATIVE DATE SIGNED C-57 LICENSE NUMBER

Owner's Well No. 7913

Date Work Began 1/27/06, Ended 2/7/06

Local Permit Agency SUTTER COUNTY HEALTH DEPT

Permit No. 05-0260 Permit Date 10/28/05

STATE OF CALIFORNIA
WELL COMPLETION REPORT

Refer to Instruction Pamphlet

No. **E036360**

DWR USE ONLY - DO NOT FILL IN

15N 02E 24

STATE WELL NO./STATION NO.

LATITUDE LONGITUDE

APN/TRS/OTHER

ORIENTATION (✓)		DRILLING METHOD		DESCRIPTION <i>Describe material, grain, size, color, etc.</i>
DEPTH FROM SURFACE Ft. to Ft.	VERTICAL HORIZONTAL ANGLE (SPECIFY)	ROTARY	FLUID MUD	
0	20			TOP SOIL AND BROWN CLAY WITH SAND
20	55			YELLOW BROWN CLAY WITH COARSE SAND
55	100			SAND AND GRAVEL
100	160			LARGE GRAVEL WITH SANDY YELLOW CLAY
160	300			YELLOW BROWN CLAY WITH SAND AND GRAV
300	360			SAND AND GRAVEL WITH YELLOW BROWN CL
360	650			SAND AND SMALL GRAVEL WITH YELLOW BROWN CLAY
650	670			SAND AND SMALL GRAVEL WITH RED BROWN CLAY
670	700			BLACK COARSE SAND

WELL OWNER

Name SUTTER EXTENTION WATER DIS

Mailing Address 4525 FRANKLIN ROAD
YUBA CITY CA 95993

CITY STATE ZIP

WELL LOCATION

Address 300' NOF FRANKLIN RD & .52 MI WOF TOWNSHI
City RD CA
County SUTTER

APN Book 013 Page 280 Parcel 054
Township 15 N Range 2 E Section 24

Latitude _____ DEG. MIN. SEC. Longitude _____ DEG. MIN. SEC.

LOCATION SKETCH

NORTH _____ SOUTH _____

WEST _____ EAST _____

Illustrate or Describe Distance of Well from Roads, Buildings, Fences, Rivers, etc. and attach a map. Use additional paper if necessary. PLEASE BE ACCURATE & COMPLETE.

ACTIVITY (✓)

NEW WELL

MODIFICATION/REPAIR
 Deepen
 Other (Specify) _____

DESTROY (Describe Procedures and Materials Under "GEOLOGIC LOG")

PLANNED USES (✓)

WATER SUPPLY
 Domestic Public
 Irrigation Industrial

MONITORING
 TEST WELL _____
 CATHODIC PROTECTION _____
 HEAT EXCHANGE _____
 DIRECT PUSH _____
 INJECTION _____
 VAPOR EXTRACTION _____
 SPARGING _____
 REMEDIATION _____
 OTHER (SPECIFY) _____

WATER LEVEL & YIELD OF COMPLETED WELL

DEPTH TO FIRST WATER _____ (Ft.) BELOW SURFACE

DEPTH OF STATIC WATER LEVEL _____ (Ft.) & DATE MEASURED _____

ESTIMATED YIELD * _____ (GPM) & TEST TYPE _____

TEST LENGTH _____ (Hrs.) TOTAL DRAWDOWN _____ (Ft.)

May not be representative of a well's long-term yield.

DEPTH FROM SURFACE Ft. to Ft.	BORE-HOLE DIA. (Inches)	CASING (S)					
		TYPE (✓)	MATERIAL / GRADE	INTERNAL DIAMETER (Inches)	GAUGE OR WALL THICKNESS	SLOT SIZE IF ANY (Inches)	
354	374	14	✓	PVC	2.5	SCH 80	.030
374	379	14	✓	PVC	2.5	SCH 80	
ZONE 3							
0	438	14/8.5	✓	PVC	2.5	SCH 80	
438	478	8.5	✓	PVC	2.5	SCH 80	.030
478	488	8.5	✓	PVC	2.5	SCH 80	

DEPTH FROM SURFACE Ft. to Ft.	ANNULAR MATERIAL			
	CE-MENT (✓)	BEN-TONITE (✓)	FILL (✓)	FILTER PACK (TYPE/SIZE)
330			✓	SRI#8 SAND
380		✓		BENTONITE C
406			✓	SRI#8 SAND
490		✓		BENTONITE C
498			✓	SRI#8 SAND
537		✓		BENTONITE C

- ATTACHMENTS (✓)**
- Geologic Log
 - Well Construction Diagram
 - Geophysical Log(s)
 - Soil/Water Chemical Analysis
 - Other _____
- ATTACH ADDITIONAL INFORMATION, IF IT EXISTS.

CERTIFICATION STATEMENT

I, the undersigned, certify that this report is complete and accurate to the best of my knowledge and belief.

NAME EATON DRILLING CO
(PERSON, FIRM, OR CORPORATION) (TYPED OR PRINTED)

20 WEST KENTUCKY AVE
ADDRESS WOODLAND CA 95695
CITY STATE ZIP

Signed Mark Davis DATE SIGNED 02/23/06
WELL DRILLER/AUTHORIZED REPRESENTATIVE C57 A HIC - 133783
DATE SIGNED C-57 LICENSE NUMBER

Owner's Well No. 7913

Date Work Began 1/27/06, Ended 2/7/06

Local Permit Agency SUTTER COUNTY HEALTH DEPT

Permit No. 05-0260 Permit Date 10/28/05

STATE OF CALIFORNIA
WELL COMPLETION REPORT

Refer to Instruction Pamphlet

No. **E036360**

pg. 3

DWR USE ONLY - DO NOT FILL IN

15202624

STATE WELL NO./STATION NO.

LATITUDE LONGITUDE

APN/TRS/OTHER

ORIENTATION (✓)		DRILLING METHOD	FLUID MUD	DESCRIPTION
<input checked="" type="checkbox"/> VERTICAL <input type="checkbox"/> HORIZONTAL <input type="checkbox"/> ANGLE _____ (SPECIFY)		<input checked="" type="checkbox"/> ROTARY	<input type="checkbox"/> _____	Describe material, grain, size, color, etc.
DEPTH FROM SURFACE				
Ft.	to Ft.			
0	20	TOP SOIL AND BROWN CLAY WITH SAND		
20	55	YELLOW BROWN CLAY WITH COARSE SAND		
55	100	SAND AND GRAVEL		
100	160	LARGE GRAVEL WITH SANDY YELLOW CLAY		
160	300	YELLOW BROWN CLAY WITH SAND AND GRAV		
300	360	SAND AND GRAVEL WITH YELLOW BROWN CL		
360	650	SAND AND SMALL GRAVEL WITH YELLOW BROWN CLAY		
650	670	SAND AND SMALL GRAVEL WITH RED BROWN CLAY		
670	700	BLACK COARSE SAND		

WELL OWNER

Name SUTTER EXTENTION WATER DIS

Mailing Address 4525 FRANKLIN ROAD
YUBA CITY CA 95993

CITY STATE ZIP

WELL LOCATION

Address 300' NOF FRANKLIN RD & 52 MI WOF TOWNSHI

City RD CA

County SUTTER

APN Book Q13 Page 280 Parcel 054

Township 15 N Range 2 E Section 24

Latitude _____

LOCATION SKETCH

NORTH

WEST EAST

SOUTH

Illustrate or Describe Distance of Well from Roads, Buildings, Fences, Rivers, etc. and attach a map. Use additional paper if necessary. PLEASE BE ACCURATE & COMPLETE.

ACTIVITY (✓)

NEW WELL

MODIFICATION/REPAIR
 Deepen
 Other (Specify) _____

DESTROY (Describe Procedures and Materials Under "GEOLOGIC LOG")

PLANNED USES (✓)

WATER SUPPLY
 Domestic Public
 Irrigation Industrial

MONITORING

TEST WELL

CATHODIC PROTECTION

HEAT EXCHANGE

DIRECT PUSH

INJECTION

VAPOR STRAPPING

SPARGING

REMEDICATION

OTHER (SPECIFY) _____

WATER LEVEL & YIELD OF COMPLETED WELL

DEPTH TO FIRST WATER _____ (Ft.) BELOW SURFACE

DEPTH OF STATIC WATER LEVEL _____ (Ft.) & DATE MEASURED _____

ESTIMATED YIELD _____ (GPM) & TEST TYPE _____

TEST LENGTH _____ (Hrs.) TOTAL DRAWDOWN _____ (Ft.)

May not be representative of a well's long-term yield.

DEPTH FROM SURFACE	BORE-HOLE DIA. (Inches)	CASING (S)					
		TYPE (✓)	MATERIAL / GRADE	INTERNAL DIAMETER (Inches)	GAUGE OR WALL THICKNESS	SLOT SIZE IF ANY (Inches)	
Ft.	to Ft.	BLANK SCREEN CON-DUCTOR FILL PIPE					
ZONE 1							
0	204	14	✓	PVC	2.5	SCH 80	
204	244	14	✓	PVC	2.5	SCH 80	.030
244	254	14	✓	PVC	2.5	SCH 80	
ZONE 2							
0	354	14	✓	PVC	2.5	SCH 80	

DEPTH FROM SURFACE	ANNULAR MATERIAL				
	TYPE				
Ft.	to Ft.	CE-MENT (✓)	BEN-TONITE (✓)	FILL (✓)	FILTER PACK (TYPE/SIZE)
548	602			✓	SR#8 SAND
602	608		✓		BENTONITE C
608	620			✓	NATIVE FILL

ATTACHMENTS (✓)

Geologic Log

Well Construction Diagram

Geophysical Log(s)

Soil/Water Chemical Analysis

Other _____

ATTACH ADDITIONAL INFORMATION, IF IT EXISTS.

CERTIFICATION STATEMENT

I, the undersigned, certify that this report is complete and accurate to the best of my knowledge and belief.

NAME EATON DRILLING CO
(PERSON, FIRM, OR CORPORATION) (TYPED OR PRINTED)

ADDRESS 20 WEST KENTUCKY AVE WOODLAND CA 95695
CITY STATE ZIP

Signed Mark Dawson 02/23/08 DATE SIGNED

WELL DRILLER/AUTHORIZED REPRESENTATIVE C-57 A HIC - 133783 C-57 LICENSE NUMBER

E 036360

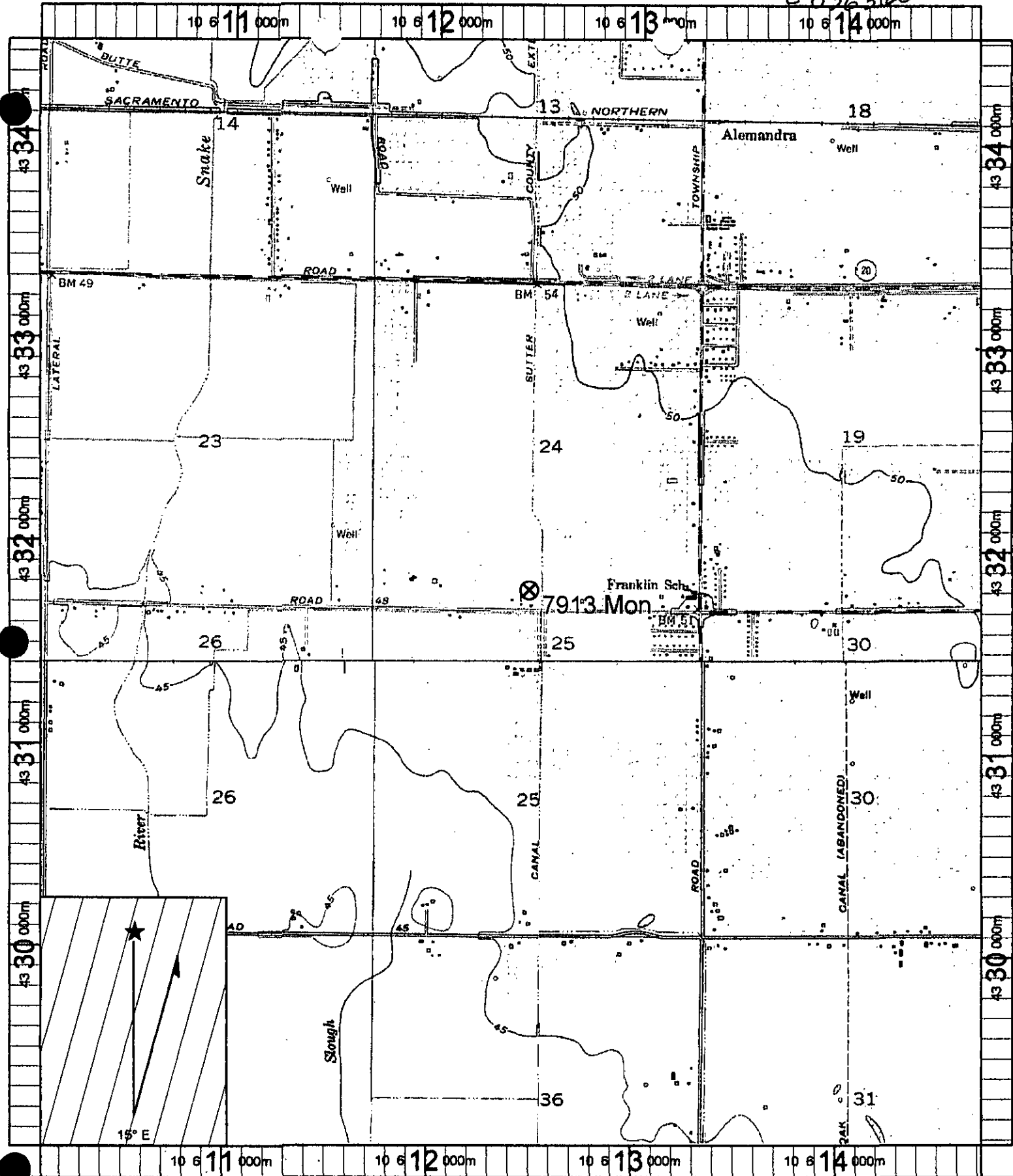

Name: SUTTER
 Date: 10/28/2005
 Scale: 1 inch equals 2000 feet

Caption: Sutter Extension Water District - Job# 7813 Mon
 APN: 013-280-054
 T15N R2E s24

STATE OF CALIFORNIA
WELL COMPLETION REPORT
Refer to Instruction Pamphlet

DWR USE ONLY -- DO NOT FILL IN
14N 02E 73A 003M
STATE WELL NO / STATION NO
004M
LATTITUDE
LONGITUDE
005M
APN/TRS/OTHER

Page 1 of 6

Owner's Well No. 7914

No. **E038757**

Date Work Began 11/21/2005, Ended 12/1/2005

Local Permit Agency SUTTER COUNTY HEALTH DEPT

Permit No. 05-0258 Permit Date 10/28/2005

GEOLOGIC LOG

ORIENTATION (✓)		DRILLING METHOD	FLUID MUD	DESCRIPTION
<input checked="" type="checkbox"/> VERTICAL <input type="checkbox"/> HORIZONTAL <input type="checkbox"/> ANGLE _____ (SPECIFY)		<input checked="" type="checkbox"/> ROTARY		Describe material, grain, size, color, etc.
DEPTH FROM SURFACE				
Ft.	to Ft.			
0	10	SANDY CLAY		
10	35	BROWN CLAY		
35	90	GRAVELLY SAND		
90	115	GRAVEL		
115	195	GRAVELLY CLAY		
195	280	CLAY TO SILT		
280	300	SILT TO CLAY		
300	348	CLAY WITH GRAVEL TO SILT WITH GRAVEL		
348	397	SILT TO CLAY		
397	536	SANDY CLAY		
536	548	SILT TO CLAY		
548	571	WELL GRADED GRAVEL WITH CLAY		
571	613	CLAY WITH SAND		
613	662	WELL GRADED SAND WITH CLAY AND GRAVEL		
662	678	CLAY WITH SAND		
678	700	CLAYEY SAND		
700	710	CLAY TO SILT		
710	750	CLAYEY SAND		
A - 003M				
B - 004M				
C - 005M				
TOTAL DEPTH OF BORING 740 (Feet)				
TOTAL DEPTH OF COMPLETED WELL 585 (Feet)				

WELL OWNER

Name SUTTER EXTENTION WATER DIS
Mailing Address 4525 FRANKLIN ROAD
YUBA CITY CA 95993
CITY STATE ZIP

WELL LOCATION

Address 250' SOF OSWALD RD & 75 WOF S
City TOWNSHIP RD CA
County SUTTER
APN Book 021 Page 310 Parcel 048
Township 14 N Range 2 E Section 13
Latitude _____

LOCATION SKETCH		ACTIVITY (✓)			
DEG.	MIN.	SEC.	DEG.	MIN.	SEC.
NORTH			<input checked="" type="checkbox"/> NEW WELL		
WEST			MODIFICATION/REPAIR		
			<input type="checkbox"/> Deepen <input type="checkbox"/> Other (Specify)		
SOUTH			<input type="checkbox"/> DESTROY (Describe Procedures and Materials Under "GEOLOGIC LOG")		
			PLANNED USES (✓) WATER SUPPLY <input type="checkbox"/> Domestic <input type="checkbox"/> Public <input type="checkbox"/> Irrigation <input type="checkbox"/> Industrial <input checked="" type="checkbox"/> MONITORING <input type="checkbox"/> TEST WELL <input type="checkbox"/> CATHODIC PROTECTION <input type="checkbox"/> HEAT EXCHANGE <input type="checkbox"/> DIRECT PUSH <input type="checkbox"/> INJECTION <input type="checkbox"/> VAPOR EXTRACTION <input type="checkbox"/> SPARGING <input type="checkbox"/> REMEDIATION <input type="checkbox"/> OTHER (SPECIFY)		

Illustrate or Describe Distance of Well from Roads, Buildings, Fences, Rivers, etc. and attach a map. Use additional paper if necessary. PLEASE BE ACCURATE & COMPLETE.

WATER LEVEL & YIELD OF COMPLETED WELL

DEPTH TO FIRST WATER _____ (Ft.) BELOW SURFACE
DEPTH OF STATIC WATER LEVEL _____ (Ft.) & DATE MEASURED
ESTIMATED YIELD * _____ (GPM) & TEST TYPE
TEST LENGTH _____ (Hrs.) TOTAL DRAWDOWN _____ (Ft.)
May not be representative of a well's long-term yield.

DEPTH FROM SURFACE	BORE-HOLE DIA. (Inches)	CASING (S)				MATERIAL / GRADE	INTERNAL DIAMETER (Inches)	GAUGE OR WALL THICKNESS	SLOT SIZE IF ANY (Inches)	DEPTH FROM SURFACE	ANNULAR MATERIAL				
		TYPE (✓)									TYPE				
Ft.	to Ft.	BLANK	SCREEN	CONDUCTOR	FILL PIPE				Ft.	to Ft.	CE-MENT (✓)	BEN-TONITE (✓)	FILL (✓)	FILTER PACK (TYPE/SIZE)	
A															
ZONE 1	1									0	68	✓			SAND SLURRY
0	88	14	✓			PVC	2.5	SCH 80		68	80		✓		BENTONITE C.
88	108	14		✓		PVC	2.5	SCH 80	.030	80	128			✓	SRI#8 SAND
108	113	14	✓			PVC	2.5	SCH 80		128	140		✓		BENTONITE C.
B															
ZONE 2	2									140	170			✓	PEA GRAVEL
0	208	14	✓			PVC	2.5	SCH 80		170	181		✓		BENTONITE C.

ATTACHMENTS (✓)

- Geologic Log
- Well Construction Diagram
- Geophysical Log(s)
- Soil/Water Chemical Analysis
- Other _____

ATTACH ADDITIONAL INFORMATION, IF IT EXISTS.

CERTIFICATION STATEMENT

I, the undersigned, certify that this report is complete and accurate to the best of my knowledge and belief.

NAME EATON DRILLING CO.

(PERSON, FIRM, OR CORPORATION) (TYPED OR PRINTED)

20 WEST KENTUCKY AVE

ADDRESS

WOODLAND

CITY

CA

STATE

95695

ZIP

Signed Mark Davison

WELL DRILLER/AUTHORIZED REPRESENTATIVE

05/02/06

DATE SIGNED

C57 A HIC - 133783

C-57 LICENSE NUMBER

ORIGINAL
File with DWR

Page 2 of 6

Owner's Well No. 7914

Date Work Began 11/21/2005, Ended 12/1/2005

Local Permit Agency SUTTER COUNTY HEALTH DEPT

Permit No. 05-0258 Permit Date 10/28/2005

STATE OF CALIFORNIA
WELL COMPLETION REPORT

Refer to Instruction Pamphlet

No. **E038757 A, B, C**

DWR USE ONLY — DO NOT FILL IN

14N02E73A003M

STATE WELL NO./STATION NO. **004M**

005M

LATITUDE _____ LONGITUDE _____

APN/TRS/OTHER _____

GEOLOGIC LOG

WELL OWNER

ORIENTATION (✓)		✓ VERTICAL	HORIZONTAL	ANGLE	(SPECIFY)
DEPTH FROM SURFACE		DRILLING METHOD ROTARY FLUID MUD			
Ft. to Ft.		DESCRIPTION			
		Describe material, grain, size, color, etc.			
0	10	SANDY CLAY			
10	35	BROWN CLAY			
35	90	GRAVELLY SAND			
90	115	GRAVEL			
115	195	GRAVELLY CLAY			
195	280	CLAY TO SILT			
280	300	SILT TO CLAY			
300	348	CLAY WITH GRAVEL TO SILT WITH GRAVEL			
348	397	SILT TO CLAY			
397	536	SANDY CLAY			
536	548	SILT TO CLAY			
548	571	WELL GRADED GRAVEL WITH CLAY			
571	613	CLAY WITH SAND			
613	662	WELL GRADED SAND WITH CLAY AND GRAVEL			
662	678	CLAY WITH SAND			
678	700	CLAYEY SAND			
700	710	CLAY TO SILT			
710	750	CLAYEY SAND			
TOTAL DEPTH OF BORING 740 (Feet)					
TOTAL DEPTH OF COMPLETED WELL 585 (Feet)					

Name **SUTTER EXTENTION WATER DIS**

Mailing Address **4525 FRANKLIN ROAD** CA **95993**

YUBA CITY STATE ZIP

WELL LOCATION

Address **250' SOF OSWALD RD & 75 WOF S**

City **TOWNSHIP RD CA**

County **SUTTER**

APN Book **021** Page **310** Parcel **048**

Township **14 N** Range **2 E** Section **13**

Latitude _____

DEG. MIN. SEC. LOCATION SKETCH NORTH SOUTH

ACTIVITY (✓)

NEW WELL

MODIFICATION/REPAIR

— Deepen

— Other (Specify)

— DESTROY (Describe Procedures and Materials Under "GEOLOGIC LOG")

PLANNED USES (✓)

WATER SUPPLY

— Domestic — Public

— Irrigation — Industrial

MONITORING

TEST WELL _____

CATHODIC PROTECTION _____

HEAT EXCHANGE _____

DIRECT PUSH _____

INJECTION _____

VAPOR EXTRACTION _____

SPARGING _____

REMEDICATION _____

OTHER (SPECIFY) _____

WEST EAST

Illustrate or Describe Distance of Well from Roads, Buildings, Fences, Rivers, etc. and attach a map. Use additional paper if necessary. PLEASE BE ACCURATE & COMPLETE.

A - 003M
B - 004M
C - 005M

WATER LEVEL & YIELD OF COMPLETED WELL

DEPTH TO FIRST WATER _____ (Ft.) BELOW SURFACE

DEPTH OF STATIC WATER LEVEL _____ (Ft.) & DATE MEASURED _____

ESTIMATED YIELD * _____ (GPM) & TEST TYPE _____

TEST LENGTH _____ (Hrs.) TOTAL DRAWDOWN _____ (Ft.)

May not be representative of a well's long-term yield.

DEPTH FROM SURFACE	BORE-HOLE DIA. (Inches)	CASING (S)				MATERIAL / GRADE	INTERNAL DIAMETER (Inches)	GAUGE OR WALL THICKNESS	SLOT SIZE IF ANY (Inches)	ANNULAR MATERIAL TYPE			
		TYPE (✓)	BLANK	SCREEN	CON-DUCTOR					FILL PIPE	CE-MENT (✓)	BEN-TONITE (✓)	FILL (✓)
208	238	14				PVC	2.5	SCH 80	.030				SRI#8 SAND
238	243	14	✓			PVC	2.5	SCH 80					BENTONITE C
ZONE 3													
0	550	14/8.75	✓			PVC	2.5	SCH 80					PEA GRAVEL
550	580	8.75	✓			PVC	2.5	SCH 80	.030				BENTONITE C
580	585	8.75	✓			PVC	2.5	SCH 80					PEA GRAVEL
													BENTONITE C

ATTACHMENTS (✓)

— Geologic Log

— Well Construction Diagram

— Geophysical Log(s)

— Soil/Water Chemical Analysis

— Other _____

ATTACH ADDITIONAL INFORMATION, IF IT EXISTS.

CERTIFICATION STATEMENT

I, the undersigned, certify that this report is complete and accurate to the best of my knowledge and belief.

NAME **EATON DRILLING CO.**

(PERSON, FIRM, OR CORPORATION) (TYPED OR PRINTED)

ADDRESS **20 WEST KENTUCKY AVE** CITY **WOODLAND** STATE **CA** ZIP **95695**

Signed **Mark Dawson** DATE SIGNED **05/02/06** C57 A HIC - 133783

WELL DRILLER/AUTHORIZED REPRESENTATIVE DATE SIGNED C-57 LICENSE NUMBER

STATE OF CALIFORNIA
WELL COMPLETION REPORT
Refer to Instruction Pamphlet
No. **E038757**

DWR USE ONLY -- DO NOT FILL IN
14N02E73A003M
STATE WELL NO./STATION NO. **004M**
005M
LATITUDE _____ LONGITUDE _____
APN/TRS/OTHER _____

Owner's Well No. **7914**
Date Work Began **11/21/2005**, Ended **12/1/2005**
Local Permit Agency **SUTTER COUNTY HEALTH DEPT**
Permit No. **05-0258** Permit Date **10/28/2005**

DEPTH FROM SURFACE		DESCRIPTION
Ft.	to Ft.	
0	10	SANDY CLAY
10	35	BROWN CLAY
35	90	GRAVELLY SAND
90	115	GRAVEL
115	195	GRAVELLY CLAY
195	280	CLAY TO SILT
280	300	SILT TO CLAY
300	348	CLAY WITH GRAVEL TO SILT WITH GRAVEL
348	397	SILT TO CLAY
397	536	SANDY CLAY
536	548	SILT TO CLAY
548	571	WELL GRADED GRAVEL WITH CLAY
571	613	CLAY WITH SAND
613	662	WELL GRADED SAND WITH CLAY AND GRAVEL
662	678	CLAY WITH SAND
678	700	CLAYEY SAND
700	710	CLAY TO SILT
710	750	CLAYEY SAND

ORIENTATION (✓): VERTICAL HORIZONTAL ANGLE _____ (SPECIFY)
DRILLING METHOD ROTARY FLUID MUD
Describe material, grain, size, color, etc.

TOTAL DEPTH OF BORING **740** (Feet)
TOTAL DEPTH OF COMPLETED WELL **585** (Feet)

WELL OWNER
Name **SUTTER EXTENTION WATER DIS**
Mailing Address **4525 FRANKLIN ROAD**
YUBA CITY CA 95993
CITY STATE ZIP

WELL LOCATION
Address **250' SOF OSWALD RD & 75' WOF S**
City **TOWNSHIP RD CA**
County **SUTTER**
APN Book **021** Page **310** Parcel **048**
Township **14 N** Range **2 E** Section **13**
Latitude _____
DEG. MIN. SEC. _____

LOCATION SKETCH
NORTH _____
WEST _____ EAST _____ SOUTH _____
Illustrate or Describe Distance of Well from Roads, Buildings, Fences, Rivers, etc. and attach a map. Use additional paper if necessary. PLEASE BE ACCURATE & COMPLETE.

ACTIVITY (✓)
 NEW WELL
MODIFICATION/REPAIR
 Deepen
 Other (Specify) _____
 DESTROY (Describe Procedures and Materials Under "GEOLOGIC LOG")

PLANNED USES (✓)
WATER SUPPLY
 Domestic Public
 Irrigation Industrial
MONITORING
TEST WELL _____
CATHODIC PROTECTION _____
HEAT EXCHANGE _____
DIRECT PUSH _____
INJECTION _____
VAPOR EXTRACTION _____
SPARGING _____
REMEDICATION _____
OTHER (SPECIFY) _____

WATER LEVEL & YIELD OF COMPLETED WELL
DEPTH TO FIRST WATER _____ (Ft.) BELOW SURFACE
DEPTH OF STATIC WATER LEVEL _____ (Ft.) & DATE MEASURED _____
ESTIMATED YIELD * _____ (GPM) & TEST TYPE _____
TEST LENGTH _____ (Hrs.) TOTAL DRAWDOWN _____ (Ft.)
May not be representative of a well's long-term yield.

DEPTH FROM SURFACE	BORE-HOLE DIA. (Inches)	CASING (S)							
		TYPE (✓)				MATERIAL / GRADE	INTERNAL DIAMETER (Inches)	GAUGE OR WALL THICKNESS	SLOT SIZE IF ANY (Inches)
Ft.	to Ft.	BLANK	SCREEN	CONDUCTOR	FILL PIPE				
ZONE 1									
0	88	14	✓			PVC	2.5	SCH 80	
88	108	14		✓		PVC	2.5	SCH 80	.030
108	113	14	✓			PVC	2.5	SCH 80	
ZONE 2									
0	208	14	✓			PVC	2.5	SCH 80	

DEPTH FROM SURFACE	ANNULAR MATERIAL				
	TYPE				
Ft.	to Ft.	CE-MENT (✓)	BEN-TONITE (✓)	FILL (✓)	FILTER PACK (TYPE/SIZE)
543	600			✓	SRI#8 SAND
600	610		✓		BENTONITE C
610	659			✓	PEA GRAVEL
659	669		✓		BENTONITE C
669	740			✓	BACKFILL

- ATTACHMENTS (✓)**
- Geologic Log
 - Well Construction Diagram
 - Geophysical Log(s)
 - Soil/Water Chemical Analysis
 - Other _____
- ATTACH ADDITIONAL INFORMATION, IF IT EXISTS.

CERTIFICATION STATEMENT
I, the undersigned, certify that this report is complete and accurate to the best of my knowledge and belief.
NAME **EATON DRILLING CO.**
(PERSON, FIRM, OR CORPORATION) (TYPED OR PRINTED)
ADDRESS **20 WEST KENTUCKY AVE** CITY **WOODLAND** STATE **CA** ZIP **95695**
Signed **Mark Davison** DATE SIGNED **05/02/06** C57 A HIC - 133783
WELL DRILLER/AUTHORIZED REPRESENTATIVE C-57 LICENSE NUMBER

2038757

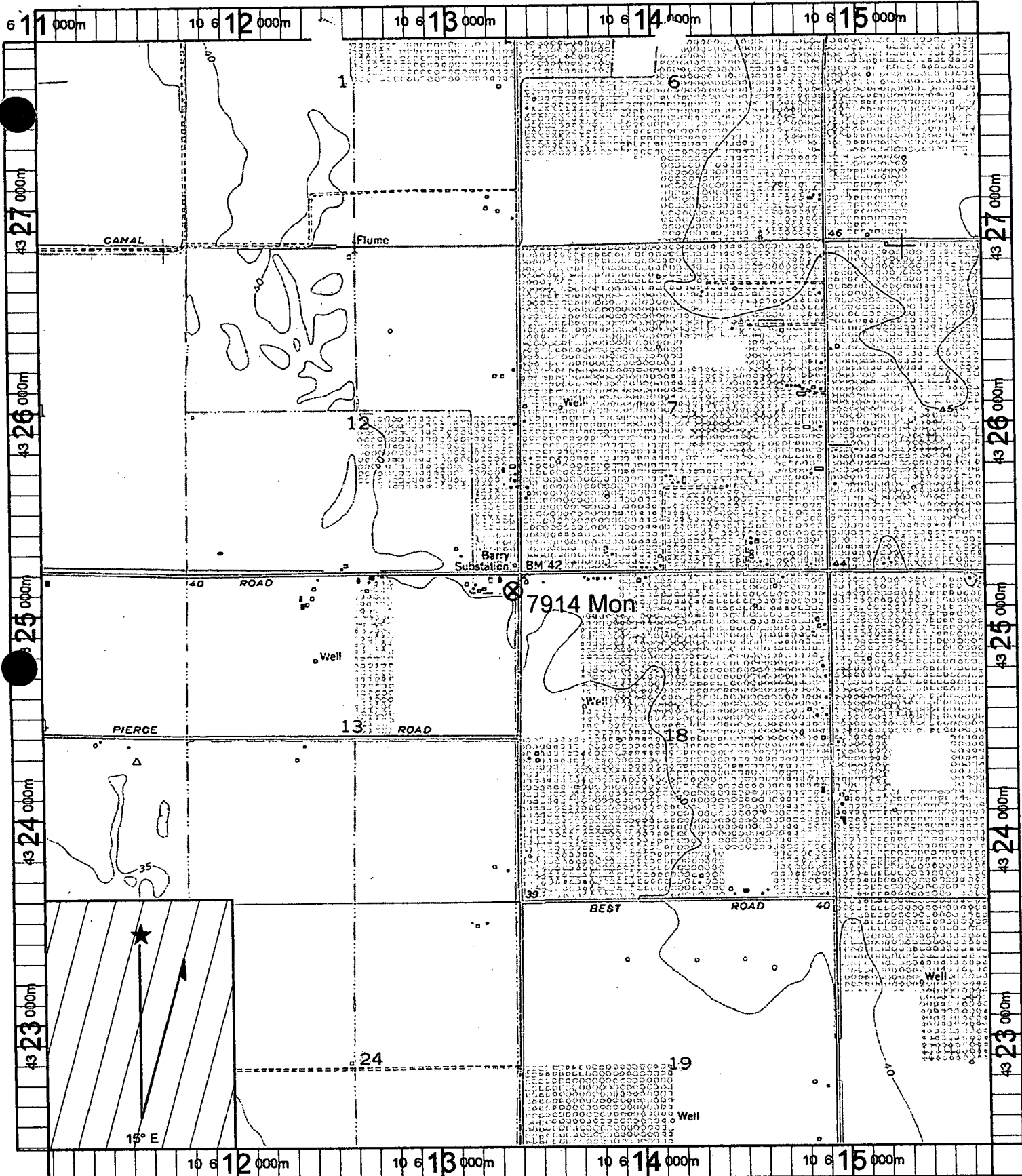

Name: GILSIZER SLOUGH
 Date: 10/28/2005
 Scale: 1 inch equals 2000 feet

Caption: Sutter Extension Water District - Job# 7814 Mon
 APN: 021-310-048
 T14N R2E s13

ORIGINAL
File with DWR

STATE OF CALIFORNIA
WELL COMPLETION REPORT
Refer to Instruction Pamphlet

DWR USE ONLY -- DO NOT FILL IN

13N03E06A001M

STATE WELL NO./STATION NO. **2**

LATITUDE _____ LONGITUDE **3**

APN/TRS/OTHER _____

Page 1 of 3
Owner's Well No. **8519 MW-6A,B,C**
Date Work Began **12/20/2010**, Ended **12/22/2010**
Local Permit Agency **Sutter County Health Dept**
Permit No. **10-0310** Permit Date **12/7/2010**

E:124062 A-C

GEOLOGIC LOG

WELL OWNER

ORIENTATION (✓) <input checked="" type="checkbox"/> VERTICAL _____ HORIZONTAL _____ ANGLE _____ (SPECIFY)	DRILLING METHOD ROTARY FLUID MUD
DEPTH FROM SURFACE	DESCRIPTION
FL. to FL.	Describe material, grain, size, color, etc.
0' 10'	Top soil
10' 20'	Yellow brown clay
20' 60'	Sand and gravel
60' 170'	Sandy yellow clay
170' 800'	Gray clay with sand
800' 1300'	Brittle gray clay with sand

Name **DWR - Central**
Mailing Address **901 P Street, 2nd Floor**
Sacramento CA 95814
CITY STATE ZIP

WELL LOCATION
Address **80' W of S George Washington Blvd & .37**
City **Mi Nof Tudor Rd CA**
County **SUTTER**
APN Book **025** Page **010** Parcel **004**
Township **13 N** Range **3 E** Section **6**
Latitude **39 0 32** **121 40 19**
DEG. MIN. SEC. DEG. MIN. SEC.

11W-6A - 13N03E06A001M
11W-6B - A002M
11W-6C - A003M

LOCATION SKETCH

NORTH _____ SOUTH _____

WEST _____ EAST _____

ACTIVITY (✓)
 NEW WELL
MODIFICATION/REPAIR
____ Deepen
____ Other (Specify) _____

DESTROY (Describe Procedures and Materials Under "GEOLOGIC LOG") _____

PLANNED USES (✓)
WATER SUPPLY
____ Domestic _____ Public
____ Irrigation _____ Industrial

MONITORING
TEST WELL _____
CATHODIC PROTECTION _____
HEAT EXCHANGE _____
DIRECT PUSH _____
INJECTION _____
VAPOR EXTRACTION _____
SPARGING _____
REMEDICATION _____
OTHER (SPECIFY) _____

Illustrate or Describe Distance of Well from Roads, Buildings, Fences, Rivers, etc. and attach a map. Use additional paper if necessary. PLEASE BE ACCURATE & COMPLETE.

WATER LEVEL & YIELD OF COMPLETED WELL.

DEPTH TO FIRST WATER _____ (Feet) BELOW SURFACE
DEPTH OF STATIC WATER LEVEL _____ (Feet) & DATE MEASURED _____
ESTIMATED YIELD * _____ (GPM) & TEST TYPE _____
TEST LENGTH _____ (Hrs.) TOTAL DRAWDOWN _____ (Feet)
May not be representative of a well's long-term yield.

DEPTH FROM SURFACE Ft. to Ft.	BORE-HOLE DIA. (Inches)	TYPE (✓)				CASING (S)			
		BLANK	SCREEN	CON-DUCTOR	FILL PIPE	MATERIAL / GRADE	INTERNAL DIAMETER (Inches)	GAUGE OR WALL THICKNESS	SLOT SIZE IF ANY (Inches)
Zone 1 0' 45'	12	✓				PVC	2.5	SCH 80	
45' 55'	12		✓			PVC	2.5	SCH 80	.030
55' 65'	12	✓				PVC	2.5	SCH 80	
Zone 2 0' 155'	12	✓				PVC	2.5	SCH 80	

DEPTH FROM SURFACE FL. to FL.	ANNULAR MATERIAL TYPE			
	CE-MENT (✓)	BEN-TONITE (✓)	FILL (✓)	FILTER PACK (TYPE/SIZE)
0' 20'	✓			Sand Slurry
20' 35'		✓		Bentonite Seal
35' 90'			✓	SRI#8 Sand
90' 100'		✓		Bentonite Seal
100' 130'			✓	SRI#8 Sand
130' 140'		✓		Bentonite Seal

ATTACHMENTS (✓)

- ____ Geologic Log
- ____ Well Construction Diagram
- ____ Geophysical Log(s)
- ____ Soil/Water Chemical Analysis
- ____ Other _____

ATTACH ADDITIONAL INFORMATION, IF IT EXISTS.

CERTIFICATION STATEMENT

I, the undersigned, certify that this report is complete and accurate to the best of my knowledge and belief.

NAME **EATON DRILLING CO.**
(PERSON, FIRM, OR CORPORATION) (TYPED OR PRINTED)

20 W. Kentucky Ave **Woodland CA 95695**
ADDRESS CITY STATE ZIP

Signed *[Signature]* **01/21/11** **C57 A 133783**
WELL DRILLER/AUTHORIZED REPRESENTATIVE DATE SIGNED C-57 LICENSE NUMBER

STATE OF CALIFORNIA
WELL COMPLETION REPORT
Refer to Instruction Pamphlet

DWR USE ONLY - DO NOT FILL IN

73M03E06

STATE WELL NO./STATION NO.

LATITUDE LONGITUDE

APN/TRS/OTHER

Owner's Well No. 8519
Date Work Began 12/20/2010, Ended 12/22/2010
Local Permit Agency Sutter County Health Dept
Permit No. 10-0310 Permit Date 12/7/2010

ED124062

GEOLOGIC LOG			WELL OWNER		
ORIENTATION (✓) <input checked="" type="checkbox"/> VERTICAL <input type="checkbox"/> HORIZONTAL <input type="checkbox"/> ANGLE _____ (SPECIFY)	DRILLING METHOD <u>ROTARY</u>	FLUID <u>MUD</u>	Name <u>DWR - Central</u>		
DEPTH FROM SURFACE	DESCRIPTION		Mailing Address <u>901 P Street, 2nd Floor</u>	CA	95814
Ft. to Ft.	Describe material, grain, size, color, etc.		CITY	STATE	ZIP
0' to 10'	Top soil		WELL LOCATION		
10' to 20'	Yellow brown clay		Address <u>80' W of S George Washington Blvd & .37</u>		
20' to 60'	Sand and gravel		City <u>Mi Nof Tudor Rd CA</u>		
60' to 170'	Sandy yellow clay		County <u>SUTTER</u>		
170' to 800'	Gray clay with sand		APN Book <u>025</u> Page <u>010</u> Parcel <u>004</u>		
800' to 1300'	Brittle gray clay with sand		Township <u>13 N</u> Range <u>3 E</u> Section <u>6</u>		
			Latitude _____		
			DEG. MIN. SEC. _____		
			LOCATION SKETCH	ACTIVITY (✓)	
			NORTH _____	<input checked="" type="checkbox"/> NEW WELL	
			WEST _____	MODIFICATION/REPAIR	
				<input type="checkbox"/> Deepen	
				<input type="checkbox"/> Other (Specify) _____	
				<input type="checkbox"/> DESTROY (Describe Procedures and Materials Under "GEOLOGIC LOG")	
				PLANNED USES (✓)	
				WATER SUPPLY	
				<input type="checkbox"/> Domestic <input type="checkbox"/> Public	
				<input type="checkbox"/> Irrigation <input type="checkbox"/> Industrial	
				MONITORING <input checked="" type="checkbox"/>	
				TEST WELL _____	
				CATHODIC PROTECTION _____	
				HEAT EXCHANGE _____	
				DIRECT PUSH _____	
				INJECTION _____	
				VAPOR EXTRACTION _____	
				SPARGING _____	
				REMEDICATION _____	
				OTHER (SPECIFY) _____	
				SOUTH _____	
			Illustrate or Describe Distance of Well from Roads, Buildings, Fences, Rivers, etc. and attach a map. Use additional paper if necessary. PLEASE BE ACCURATE & COMPLETE.		
TOTAL DEPTH OF BORING <u>1300</u> (Feet)			WATER LEVEL & YIELD OF COMPLETED WELL		
TOTAL DEPTH OF COMPLETED WELL <u>255</u> (Feet)			DEPTH TO FIRST WATER _____ (Ft.) BELOW SURFACE		
			DEPTH OF STATIC WATER LEVEL _____ (Ft.) & DATE MEASURED _____		
			ESTIMATED YIELD * _____ (GPM) & TEST TYPE _____		
			TEST LENGTH _____ (Hrs.) TOTAL DRAWDOWN _____ (Ft.)		
			May not be representative of a well's long-term yield.		

DEPTH FROM SURFACE Ft. to Ft.	BORE-HOLE DIA. (Inches)	CASING (S)				MATERIAL / GRADE	INTERNAL DIAMETER (Inches)	GAUGE OR WALL THICKNESS	SLOT SIZE IF ANY (Inches)	ANNULAR MATERIAL			
		TYPE (✓)								TYPE			
		BLANK	SCREEN	CON. DICTOR.	FILL PIPE				CE- MENT (✓)	BEN- TONITE (✓)	FILL (✓)	FILTER PACK (TYPE/SIZE)	
155 - 165	12		✓			PVC	2.5	SCH 80	.030			✓	SRI#8 Sand
165 - 175	12	✓				PVC	2.5	SCH 80			✓	Bentonite Seal	
Zone 3	12/8		✓			PVC	2.5	SCH 80			✓	SRI#8 Sand	
0 - 235	8		✓			PVC	2.5	SCH 80	.030		✓	Bentonite Seal	
235 - 245	8		✓			PVC	2.5	SCH 80			✓	SRI#8 Sand	
245 - 255	8		✓			PVC	2.5	SCH 80			✓	Bentonite Seal	

- ATTACHMENTS (✓)
- Geologic Log
 - Well Construction Diagram
 - Geophysical Log(s)
 - Soil/Water Chemical Analysis
 - Other _____
- ATTACH ADDITIONAL INFORMATION, IF IT EXISTS.

CERTIFICATION STATEMENT

I, the undersigned, certify that this report is complete and accurate to the best of my knowledge and belief.

NAME EATON DRILLING CO.
(PERSON, FIRM, OR CORPORATION) (TYPED OR PRINTED)

20 W. Kentucky Ave Woodland CA 95695
ADDRESS CITY STATE ZIP

Signed [Signature] 01/21/11 DATE SIGNED
WELL DRILLER/AUTHORIZED REPRESENTATIVE C57 A 133783 C-57 LICENSE NUMBER

ORIGINAL
File with DWR

STATE OF CALIFORNIA
WELL COMPLETION REPORT
Refer to Instruction Pamphlet

DWR USE ONLY - DO NOT FILL IN	
73M03E06	
STATE WELL NO./STATION NO.	
LATITUDE	LONGITUDE
APN/TRS/OTHER	

Page 3 of 3

Owner's Well No. 8519

EQ.124062

Date Work Began 12/20/2010, Ended 12/22/2010

Local Permit Agency Sutter County Health Dept

Permit No. 10-0310 Permit Date 12/7/2010

GEOLOGIC LOG

WELL OWNER

ORIENTATION (✓) VERTICAL HORIZONTAL ANGLE _____ (SPECIFY)

Name DWR - Central

DEPTH FROM SURFACE		DESCRIPTION
Ft.	to Ft.	

DRILLING METHOD ROTARY FLUID MUD

Mailing Address 901 P Street, 2nd Floor

Sacramento CA 95814
CITY STATE ZIP

Describe material, grain, size, color, etc.

Address 80' W of S George Washington Blvd & 37

City Mi Nof Tudor Rd CA

County SUTTER

APN Book 025 Page 010 Parcel 004

Township 13 N Range 3 E Section 6

Latitude _____

DEG. MIN. SEC.

LOCATION SKETCH

DEG. MIN. SEC.

ACTIVITY (✓)

- NEW WELL
- MODIFICATION/REPAIR
 - Deepen
 - Other (Specify) _____
- DESTROY (Describe Procedures and Materials Under "GEOLOGIC LOG")

- PLANNED USES (✓)**
- WATER SUPPLY
- Domestic Public
 - Irrigation Industrial

- MONITORING
- TEST WELL
- CATHODIC PROTECTION
- HEAT EXCHANGE
- DIRECT PUSH
- INJECTION
- VAPOR EXTRACTION
- SPARGING
- REMEDIATION
- OTHER (SPECIFY) _____

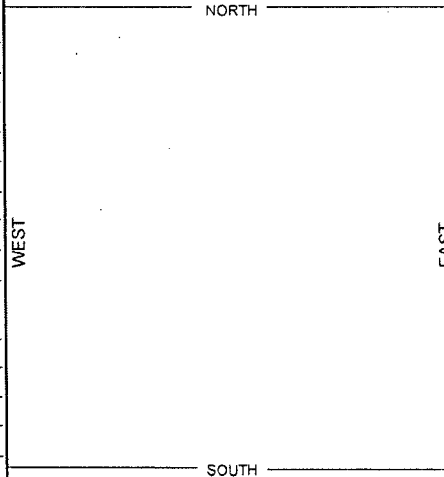

Illustrate or Describe Distance of Well from Roads, Buildings, Fences, Rivers, etc. and attach a map. Use additional paper if necessary. PLEASE BE ACCURATE & COMPLETE.

WATER LEVEL & YIELD OF COMPLETED WELL

DEPTH TO FIRST WATER _____ (Ft.) BELOW SURFACE

DEPTH OF STATIC _____

WATER LEVEL _____ (Ft.) & DATE MEASURED _____

ESTIMATED YIELD * _____ (GPM) & TEST TYPE _____

TEST LENGTH _____ (Hrs.) TOTAL DRAWDOWN _____ (Ft.)

May not be representative of a well's long-term yield.

TOTAL DEPTH OF BORING 1300 (Feet)

TOTAL DEPTH OF COMPLETED WELL 255 (Feet)

DEPTH FROM SURFACE Ft. to Ft.	BORE-HOLE DIA. (Inches)	CASING (S)				MATERIAL / GRADE	INTERNAL DIAMETER (Inches)	GAUGE OR WALL THICKNESS	SLOT SIZE IF ANY (Inches)	ANNULAR MATERIAL			
		TYPE (✓)								TYPE			
		BLANK	SCREEN	CON-DUCTOR	FILL PIPE				CE-MENT (✓)	BEN-TONITE (✓)	FILL (✓)	FILTER PACK (TYPE/SIZE)	
280	300												Native Fill
300	1300								✓				Sand Slurry

ATTACHMENTS (✓)

- Geologic Log
- Well Construction Diagram
- Geophysical Log(s)
- Soil/Water Chemical Analysis
- Other _____

ATTACH ADDITIONAL INFORMATION, IF IT EXISTS.

CERTIFICATION STATEMENT

I, the undersigned, certify that this report is complete and accurate to the best of my knowledge and belief.

NAME EATON DRILLING CO.

(PERSON, FIRM, OR CORPORATION) (TYPED OR PRINTED)

20 W. Kentucky Ave

ADDRESS

Woodland

CITY

CA

STATE

95695

ZIP

Signed [Signature]
WELL DRILLER/AUTHORIZED REPRESENTATIVE

01/21/11
DATE SIGNED

C57 A 133783
C-57 LICENSE NUMBER

00124062

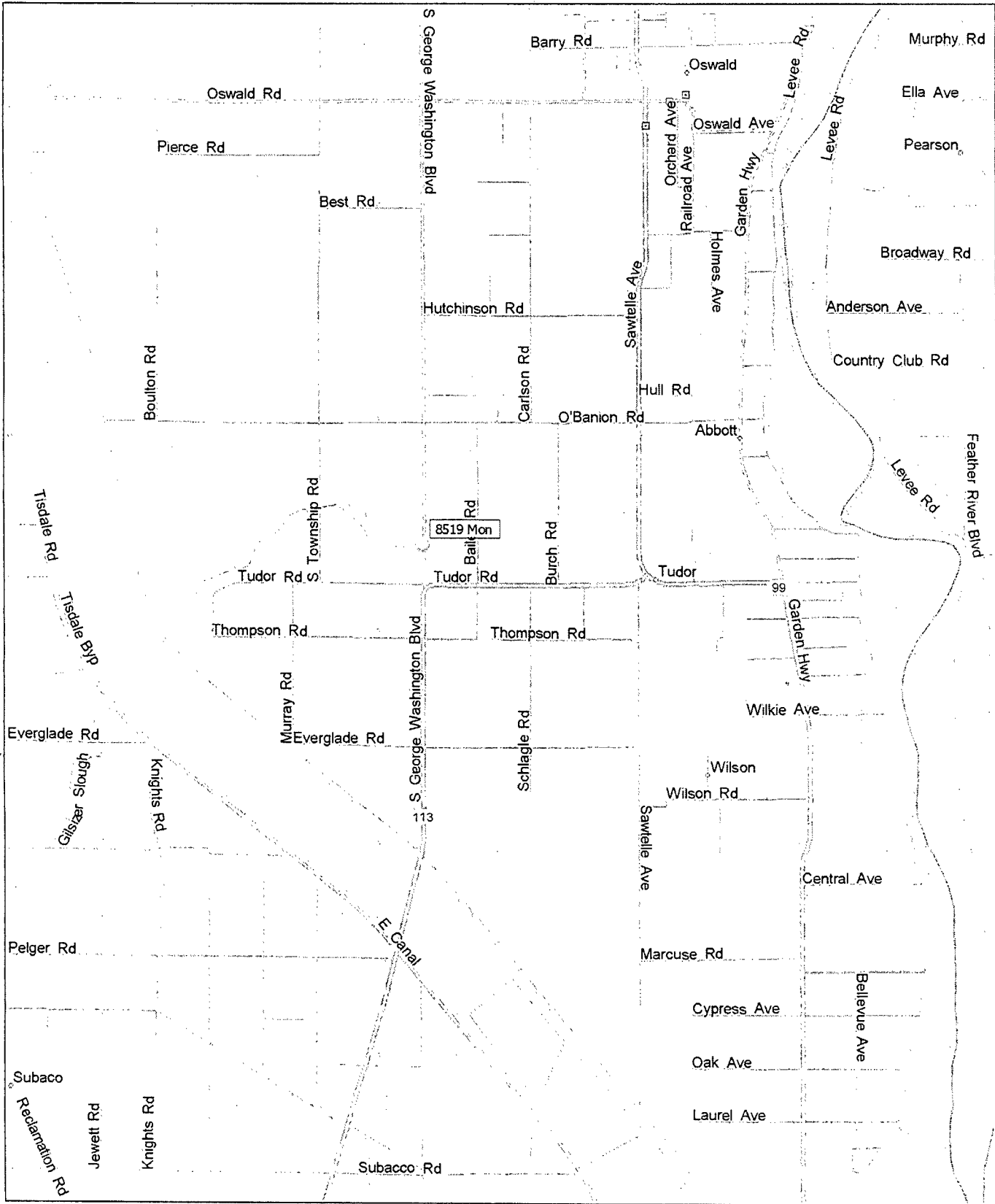

0 mi 1 2 3

State of California
The Resources Agency
DEPARTMENT OF WATER RESOURCES
DRILL HOLE LOG

PROJECT American Basin Conjunctive Use HOLE NUMBER AB-1
 FEATURE SSWD Corporation Yard DATE DRILLED 5/22/96-5/23/96
 LOCATION _____ LOGGED BY Senter/Killingsworth
 CONTRACTOR Eaton Drilling ATTITUDE Vertical
 DRILLER Duane Smith DEPTH TO WATER Not determined
 DRILL RIG Mayhew 1000, modified HOLE DEPTH 1008 ft ELEVATION N/A

Depth	Log	Field Classification and Description	Mode	Remarks
0	SM	0-30': <u>SANDY SILT</u> : soft, buff brown to red orange in color, interbedded with <u>SAND</u> , medium to pebble size, angular to subrounded, predominantly lithic clasts.	RD	Spudded @ 1000 hrs
20				
40	CL	30-50': <u>CLAY</u> : lean, contains non-plastic fines, soft, orange-brown to gray-brown in color.		
60	SP	50-100': <u>SAND</u> : coarse to med grained, loose (uncemented), angular to subangular, clasts appear to be primarily of granitic origin w/ up to 10% mafic lithic fragments. Occasional stringers of <u>SANDY SILT</u> . Grades coarser, becomes iron-oxide stained, and composed predominantly of mafic non-granitic fragments below 60'.		65': rough drilling
80				
100	SM	100-125': <u>SANDY SILT</u> : brittle (stiff), red-brown to orange-brown in color, contains up to 10% medium to coarse grained lithic fragments w/ occasional gravel-size clasts.		
120	SP	125-145': <u>SAND</u> : coarse to medium-grain size, angular to subangular, composed of mafic mineral fragments and lithic fragments of metamorphic & igneous origin.		
140	SM	145-180': <u>SANDY SILT</u> : brittle, as above, w/ common soft, non-plastic interbeds.		
160				

State of California
The Resources Agency
DEPARTMENT OF WATER RESOURCES
DRILL HOLE LOG

Project & Feature American Basin Conjunctive Use, SSWD Monitoring Well

Hole No. AB-1

Depth	Log	Field Classification and Description	Mode	Remarks
160	SM	<u>SANDY SILT</u> continued	RD	Driller said water return only about 50% from 160-180'
180	SP	180-200': <u>SAND</u> : fine to med grained minerals and lithic clasts, angular to subrounded, loose. Up to 30% of sand fragments appear to be sandstone, weakly indurated, friable. Possible lahar?		
200	SM	200-330': <u>SILTY SAND/SANDY SILT</u> interbedded: reddish brown, brittle silts, subangular, med to coarse sand. Occasional soft <u>SANDY SILT</u> interbeds, esp. below 220'. Color changes to dark gray at 230'.		
220				Assume that color change at 250' corresponds to top of Mehrten Formation Hole taking water
240		Color alternates between gray and red-brown. Degree of induration increases with depth; cuttings become harder. Below 250', color is predominantly dark gray, w/ minor orange-red interbeds.		
260		MEHRTEN FORMATION: gray to greenish, interbedded, tuffaceous sands, silts, clays, claystones, some interbedded gravels, gray tuffs, all as described below.		
280				
300				
320				5/23/96: probable Mehrten
	SP	330-340': <u>SAND</u> : fine to medium grained, dark gray, angular, loose.		
340	SM	340-390': <u>SANDY SILT</u> with occasional silty sand interbeds: brittle w/ occasional soft interbeds, dark gray w/ infrequent red-orange interbeds; sand is fine to med grained.		
360				

State of California
The Resources Agency
DEPARTMENT OF WATER RESOURCES
DRILL HOLE LOG

Project & Feature American Basin Conjunctive Use, SSWD Monitoring Well

Hole No. AB-1

Depth	Log	Field Classification and Description	Mode	Remarks
360	SM	<u>SANDY SILT</u> continued	RD	
380				
	GP	390-400': <u>SANDY GRAVEL</u> : loose, dark gray, subangular to rounded lithic and mineral clasts. Appear to be mainly metamorphics; fine; max diam. 0.5". Some basalt clasts <5%.		390': rough drilling 5/23/96 gravel zone definitely appears to be Mehrten
400	SP	400-410': <u>SAND with CLAY</u> : gray, coarse grained, otherwise same as above; contains about 10% med plastic clay		
	Tuff	410-500': <u>TUFF</u> : andesitic, gray, brittle; may occasionally grade to stiff clay; trace of subrounded pebbles.		
420				
				Good water return: about 80%
440				
460				
				Fast drilling
480				
500	SC	500-650': <u>CLAYEY SAND</u> : tuffaceous; dark gray-green, coarse grained, angular to subrounded; qtz and metamorphic grains, abundant greenish metavolcanic grains		
520				
				Fast drilling; good water returns about 80%
540				
560				

State of California
The Resources Agency
DEPARTMENT OF WATER RESOURCES
DRILL HOLE LOG

Project & Feature American Basin Conjunctive Use, SSWD Monitoring Well

Hole No. AB-1

Depth	Log	Field Classification and Description	Mode	Remarks
560	SC	<u>CLAYEY SAND</u> continued	RD	Driller says added 4 sacks bentonite earlier in day
580				
600				
620				Stopped drilling at 620'; added 5 sacks bentonite, circulated, pulled drill string Ended shift @2015 5/23/96: began shift @ 0700; ran in hole, circulated; began new hole @ 1000 hrs.
640				
660	SP	650-700': <u>SAND</u> : med to coarse, uncemented, dark gray, angular to subangular, predominantly metamorphic clasts; qtz uncommon (<5%), contains +/-10% andestic (?) clasts: plag. & hornblende xtals in red groundmass.		Penetration rate is faster than circulation rate; cuttings samples taken @ 10-' intervals are probably composite of 20' drill length
680		Below 680', qtz becomes more abundant, but still no more than 5% of returns. Cuttings also contain chips of gray, angular clasts that resemble siltstone, but are probably tuff; minor soft clay.		
700	Tuff	700-720': <u>SANDY TUFF</u> : hard, gray w/medium grain-size lithic clasts of metamorphic origin, some rhyolite/dacite; resembles siltstone.		
720	SP/ Tuff	720-820': Interbedded <u>SAND</u> and <u>TUFF</u> : as above; difficult to distinguish individual layers because tuff cuttings are the same size as sand clasts. Overall, there appears to be a 30/70 split between sand particles and sand-size tuff cuttings.		1100 hrs; fast drilling
740				
760				

State of California
The Resources Agency
DEPARTMENT OF WATER RESOURCES
DRILL HOLE LOG

Project & Feature American Basin Conjunctive Use, SSWD Monitoring Well

Hole No. AB-1

Depth	Log	Field Classification and Description	Mode	Remarks
760	SP/ Tuff	Interbedded <u>SAND and TUFF</u> continued.	RD	
780				
800				Circulating @ 1200 hrs
820	CH	820-860': <u>FAT CLAY</u> : blue-gray, tuffaceous, high plasticity, contains abundant frags of tuff <1/8" diameter.		
840				
860	Tuff	860-940': <u>TUFF with SAND</u> : gray to mostly bluish-green, andesitic tuff and/or lahar w/ minor interbedded med to coarse sand(<5%); grains are angular to subrounded, qtz, basalt, greenstone and some orange-brown tuffaceous clasts.		Circulating @1330 hrs, reamed borehole due to swelling formation; driller says fluid return is about 70%
880				Fast drilling
900				
920				
940	SP	940-970': <u>SAND</u> : tuffaceous, as previously described at 500-580', but not clayey.		
960				

State of California
The Resources Agency
DEPARTMENT OF WATER RESOURCES
DRILL HOLE LOG

Project & Feature American Basin Conjunctive Use, SSWD Monitoring Well

Hole No. AB-1

Depth	Log	Field Classification and Description	Mode	Remarks
960	SP	<u>SAND</u> continued	RD	
	Tuff	970-980': <u>TUFF with SAND</u> : andesitic, as previously described.		
980	Tuff	980-1000': <u>TUFF</u> : andesitic, as previously described, no sand or pebbles.		
1000				
1020		1008': BOTTOM OF HOLE		
1040				
1060				
1080				
1100				
1120				
1140				
1160				

State of California
The Resources Agency
Department of Water Resources

State Well No. 12N04E03N04M

DISTRICT Central

WELL DATA

Owner California Department of Water Resources
Address 3251 S Street, Sacramento 95816
Tenant _____
Address _____

State Well No. 12N04E03N04M
Other No. AB-1, Shallow

Type of Well: Hydrograph Key Index Semiannual
Location: County Sutter Basin North American No. 5-21.64
U.S.G.S. Quad. Nicholaus Quad. No. _____

SW 1/4 SW 1/4 Section 03, Township. 12N, Range. 04E MD
SB Base & Meridian
H

Description Single vault, quadruple-completion, nested piezometer. Each peizometer is 2" in diameter, steel cased, with a stainless-steel perforated interval. Vault is secured with a padlock - lock is available at Central District office.

Reference Point description Top of the 2" piezometer, with cap removed. Shallow well is the tallest of the four casings.

Which is. 1.2 ft. ^{Above} land surface. Ground Elevation 48 ft.
Reference Point Elev. 49.2 ft. _{Below} ft. Determined from USGS Quad
Well: Use Monitoring Condition Very good - nearly new Depth 190 ft.
Casing, size 2 in., perforations 170 - 180 feet bgs

Measurement By: DWR USGS USBR County Irr. Dist. Water Dist. Cons. Dist.
Chief Aquifer: Name _____ Depth to Top Aq. _____ Depth to Bot. Aq. _____
Type of Material _____ Perm. Rating _____ Thickness _____
Gravel Packed? Yes No Depth to Top Gr. 80 feet Depth to Bot. Gr. 200 feet
Supp. Aquifer _____ Depth to Top Aq. _____ Depth to Bot. Aq. _____
Driller Eaton Drilling
Date drilled May 22-23, 1996 Log, filed yes Open (1) Confidential (2) _____
Equipment: Pump, type _____ Make _____
Serial No. _____ Size of discharge pipe _____ in.
Power, Kind _____ Make _____
H.P. _____ Motor Serial No. _____
Elec. Meter No. _____ Transformer No. _____
Yield _____ GPM Pumping level _____ ft.

Water Analysis: Min. (1) San. (2) _____ H.M.(3) _____
Water Levels Available: Yes (1) No _____
Period of Record: Begin 07/11/96 End active
Collecting Agency California Department of Water Resources
Prod. Rec. (1) _____ Pump Test (2) _____ Yield (3) _____

SKETCH

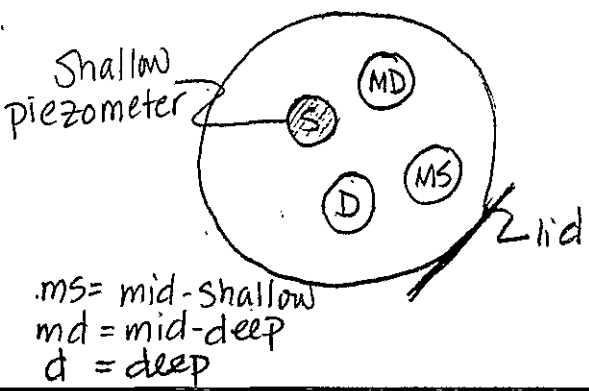

↑
N

REMARKS

This is the shallow well of a quadruple-completion monitoring well.
The middle-shallow well is 530 feet deep, the middle-deep well is 710 feet, and the deep well is 980 feet. The four wells are separated by bentonite seals. A 1" steel air tube is attached to the well casing at 150' depth, and was used for well development. The well is located within the boundaries of RD 108 and was constructed with their permission. See attached map for location. Electric log of well is on file.

Recorded by: Naomi Kalman
Date: 01/10/01

Location of AB 1
Nicholaus Quad



51-1071

1:7272

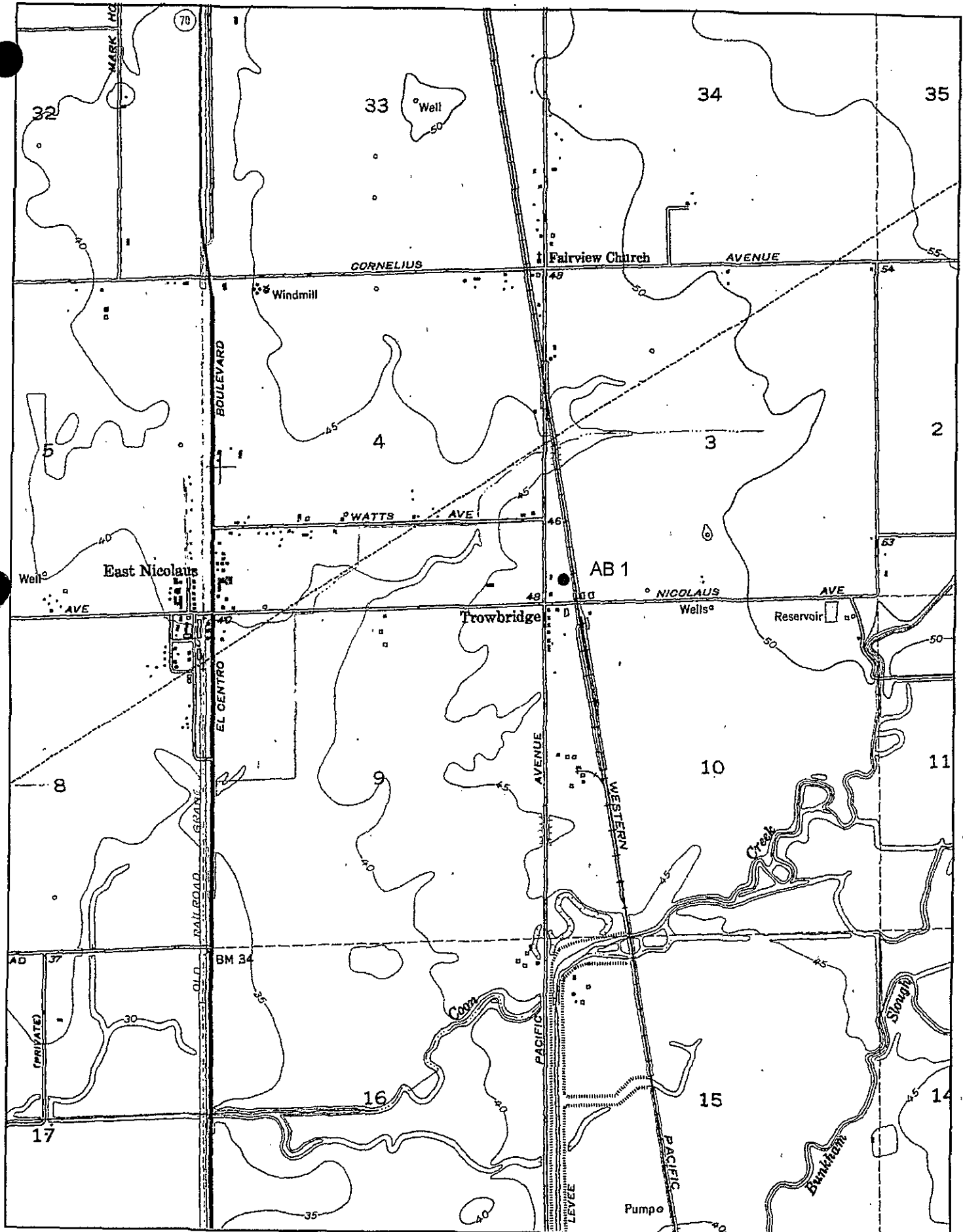

51-1069

State of California
The Resources Agency
Department of Water Resources

State Well No. 12N04E03N02M

DISTRICT Central

WELL DATA

Owner California Department of Water Resources
Address 3251 S Street, Sacramento 95816
Tenant _____
Address _____

State Well No. 12N04E03N02M
Other No. AB-1, Middle-Deep

Type of Well: Hydrograph Key Index Semiannual
Location: County Sutter Basin North American No. 5-21.64
U.S.G.S. Quad. Nicholaus Quad. No. _____

SW 1/4 SW 1/4 Section 03, Township. 12N, Range. 04E ^{MD} _{SB} _H Base & Meridian

Description Single vault, quadruple-completion, nested piezometer. Each piezometer is 2" in diameter, steel cased, with a stainless-steel perforated interval. Vault is secured with a padlock -- lock is available at Central District office.

Reference Point description Top of the 2" piezometer, with cap removed. Middle-deep well is the second shortest of the four casings.

Which is 0.9 ft. ^{Above} _{Below} land surface. Ground Elevation 48 ft.
Reference Point Elev. 48.9 ft. Determined from USGS Quad
Well: Use Monitoring Condition Very good - nearly new Depth 710 ft.
Casing, size 2 in., perforations 680 - 700 feet bgs

Measurement By: DWR USGS USBR County Irr. Dist. Water Dist. Cons. Dist.
Chief Aquifer: Name _____ Depth to Top Aq. _____ Depth to Bot. Aq. _____
Type of Material _____ Perm. Rating _____ Thickness _____
Gravel Packed? Yes No Depth to Top Gr. 620 feet Depth to Bot. Gr. 855 feet
Supp. Aquifer _____ Depth to Top Aq. _____ Depth to Bot. Aq. _____
Driller Eaton Drilling
Date drilled May 22-23, 1996 Log, filed yes Open (1) Confidential (2) _____
Equipment: Pump, type _____ Make _____
Serial No. _____ Size of discharge pipe _____ in.
Power, Kind _____ Make _____
H.P. _____ Motor Serial No. _____
Elec. Meter No. _____ Transformer No. _____
Yield _____ GPM Pumping level _____ ft.

Water Analysis: Min. (1) San. (2) _____ H.M.(3) _____
Water Levels Available: Yes (1) No _____
Period of Record: Begin 07/11/96 End active
Collecting Agency California Department of Water Resources
Prod. Rec. (1) _____ Pump Test (2) _____ Yield (3) _____

SKETCH

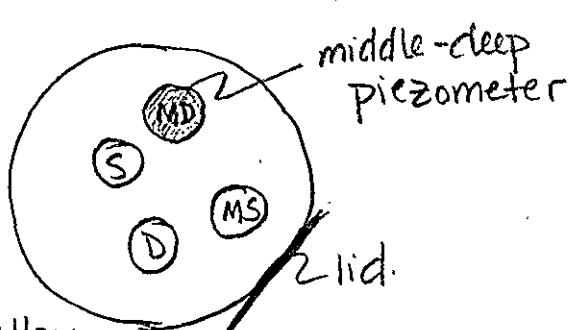

↑
N

S=shallow
ms = middle-shallow
d = deep

REMARKS

This is the middle-deep well of a quadruple-completion monitoring well. The shallow well is 190 feet deep, the middle-shallow well is 530 feet, and the deep well is 980 feet. The four wells are separated by bentonite seals. A 1" steel air tube is attached to the well casing at 150' depth, and was used for well development. The well is located within the boundaries of RD 108 and was constructed with their permission. See attached map for location. Electric log of well is on file.

Recorded by: Naomi Kalman
Date: 01/10/01

Location of AB 1:
Nicholaus Quad

51-1069

1:7272

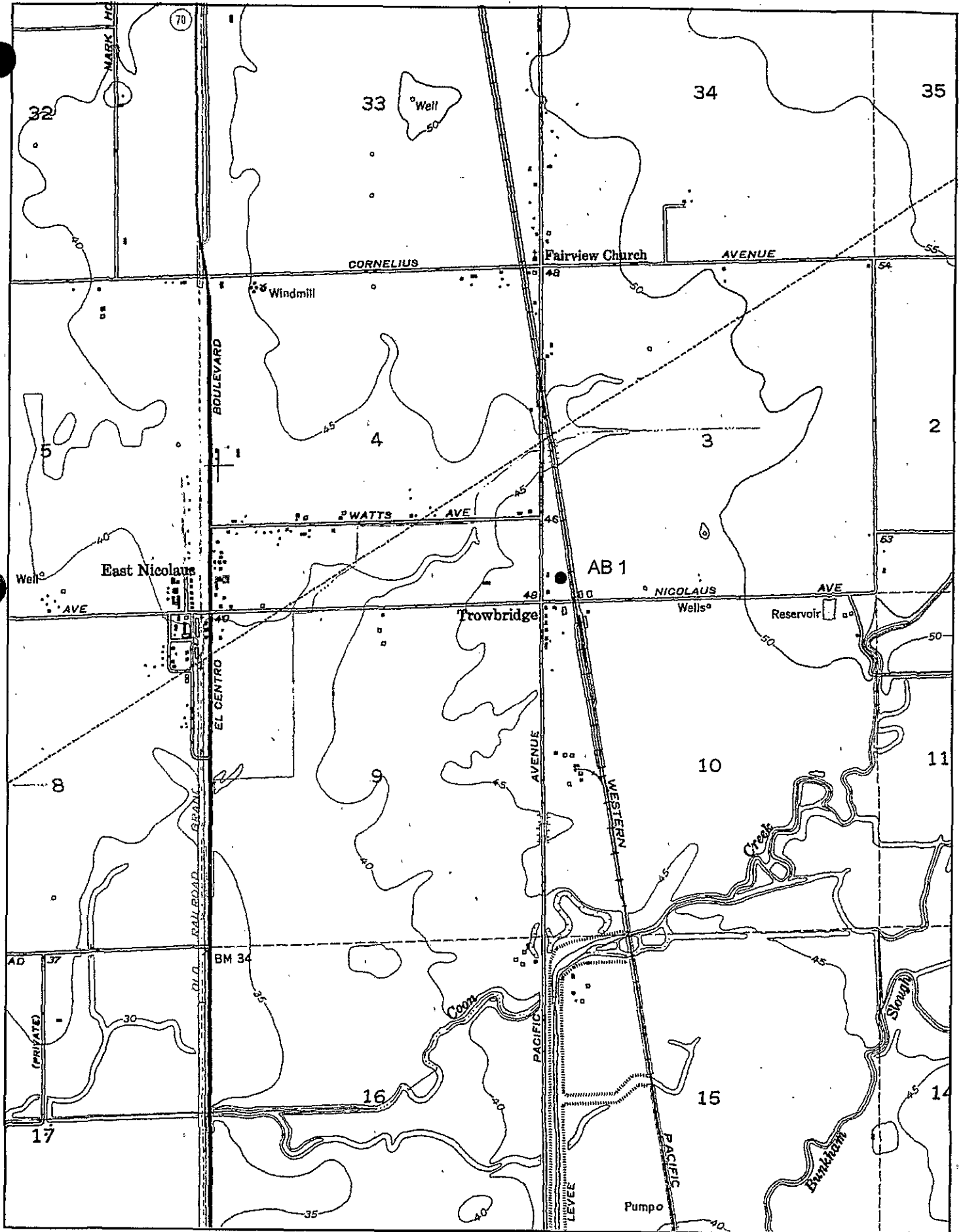

51-1070

State of California
The Resources Agency
Department of Water Resources

State Well No. 12N04E03N03M

DISTRICT Central

WELL DATA

Owner California Department of Water Resources
Address 3251 S Street, Sacramento 95816
Tenant _____
Address _____

State Well No. 12N04E03N03M
Other No. AB-1, Middle-Shallow

Type of Well: Hydrograph Key Index Semiannual
Location: County Sutter Basin North American No. 5-21.64
U.S.G.S. Quad. Nicholaus Quad. No. _____

SW 1/4 SW 1/4 Section 03, Township. 12N, Range. 04E ^{MD} _{SB} ^H Base & Meridian

Description Single vault, quadruple-completion, nested piezometer. Each peizometer is 2" in diameter, steel cased, with a stainless-steel perforated interval. Vault is secured with a padlock - lock is available at Central District office.

Reference Point description Top of the 2" piezometer, with cap removed. Middle-shallow well is the second-tallest of the four casings.

Which is 1.0 ft. ^{Above} _{Below} land surface. Ground Elevation -48 ft.
Reference Point Elev. 49 ft. Determined from USGS Quad
Well: Use Monitoring Condition Very good - nearly new Depth 530 ft.
Casing, size 2 in., perforations 390 - 400 and 510 - 520 feet bgs

Measurement By: DWR USGS USBR County Irr. Dist. Water Dist. Cons. Dist.
Chief Aquifer: Name _____ Depth to Top Aq. _____ Depth to Bot. Aq. _____
Type of Material _____ Perm. Rating _____ Thickness _____
Gravel Packed? Yes No Depth to Top Gr. 370 feet Depth to Bot. Gr. 600 feet
Supp. Aquifer _____ Depth to Top Aq. _____ Depth to Bot. Aq. _____
Driller Eaton Drilling
Date drilled May 22-23, 1996 Log, filed yes Open (1) Confidential (2) _____
Equipment: Pump, type _____ Make _____
Serial No. _____ Size of discharge pipe _____ in.
Power, Kind _____ Make _____
H.P. _____ Motor Serial No. _____
Elec. Meter No. _____ Transformer No. _____
Yield _____ GPM Pumping level _____ ft.
Water Analysis: Min. (1) San. (2) _____ H.M.(3) _____
Water Levels Available: Yes (1) No _____
Period of Record: Begin 07/11/96 End active
Collecting Agency California Department of Water Resources
Prod. Rec. (1) _____ Pump Test (2) _____ Yield (3) _____

SKETCH

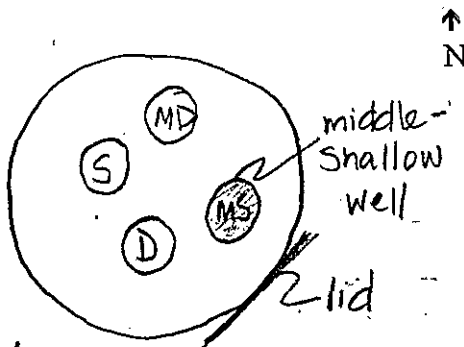

S = Shallow
md = middle deep
d = deep

REMARKS

This is the middle-shallow of a quadruple-completion monitoring well. The shallow well is 190 feet deep, the middle-deep well is 710 feet, and the deep well is 980 feet. The four wells are separated by bentonite seals. A 1" steel air tube is attached to the well casing at 150' depth, and was used for well development. The well is located within the boundaries of RD 108 and was constructed with their permission. See attached map for location. Electric log of well is on file.

Recorded by: Naomi Kalman
Date: 01/10/01

Location of AB 1
Nicholaus Quad



51-1070

1:7272

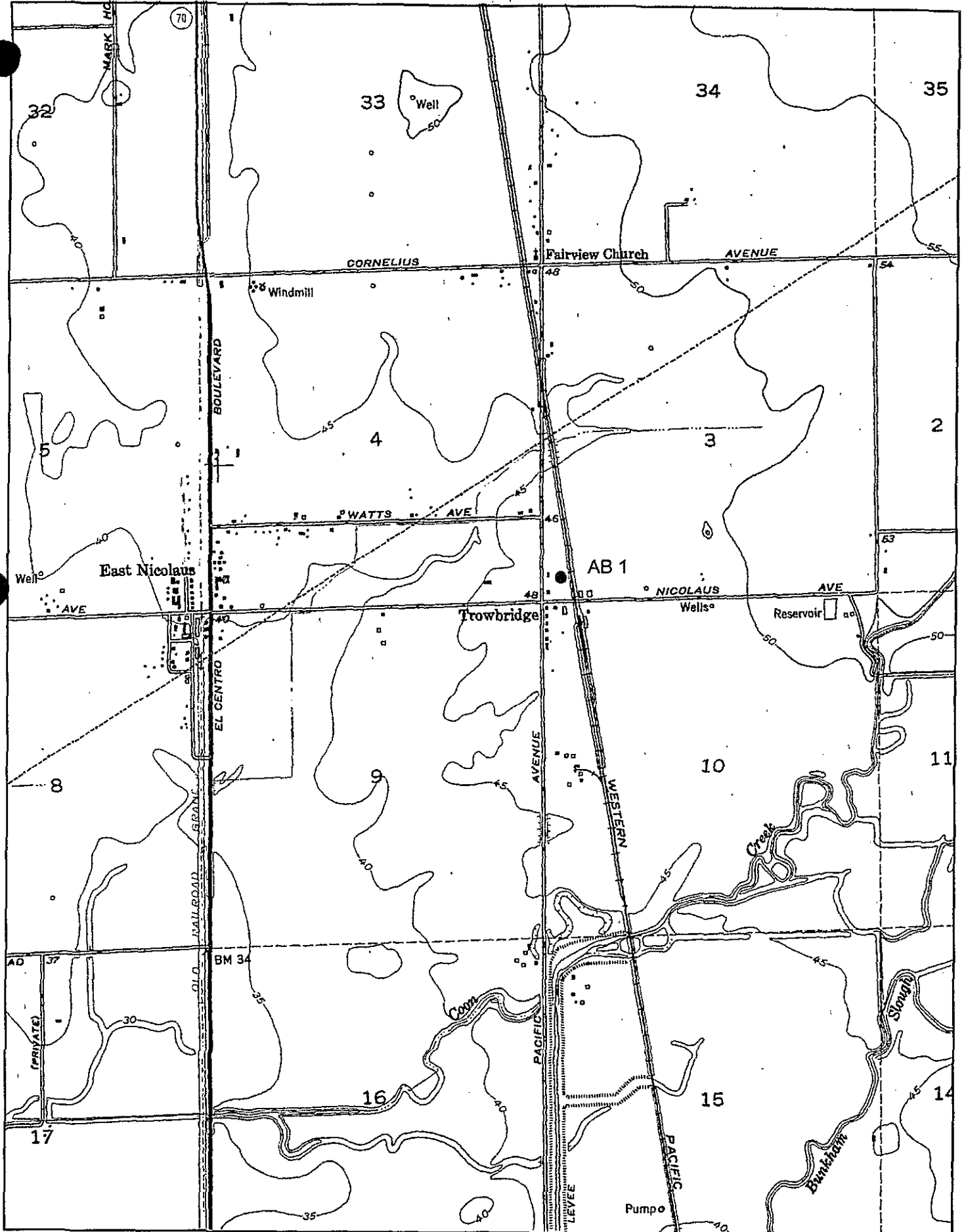

State of California
The Resources Agency
Department of Water Resources

State Well No. 12N04E03N01M

DISTRICT Central

WELL DATA

Owner	<u>California Department of Water Resources</u>	State Well No.	<u>12N04E03N01M</u>
Address	<u>3251 S Street, Sacramento 95816</u>	Other No.	<u>AB-1, Deep</u>
Tenant			
Address			

Type of Well: Hydrograph Key Index Semiannual
 Location: County Sutter Basin North American No. 5-21.64
 U.S.G.S. Quad. Nicholaus Quad. No. _____

SW 1/4 SW 1/4 Section 03, Township. 12N, Range. 04E MD
SB
H Base & Meridian

Description Single vault, quadruple-completion, nested piezometer. Each peizometer is 2" in diameter, steel cased, with a stainless-steel perforated interval. Vault is secured with a padlock - lock is available at Central District office.

Reference Point description Top of the 2" piezometer, with cap removed. Deep well is the shortest of the four casings.

Which is 0.4 ft. ^{Above} land surface. Ground Elevation 48 ft.
 Reference Point Elev. 48.4 ft. _{Below} ft. Determined from USGS Quad
 Well: Use Monitoring Condition Very good - nearly new Depth 980 ft.
 Casing, size 2 in., perforations 950 - 970 feet bgs

Measurement By: DWR USGS USBR County Irr. Dist. Water Dist. Cons. Dist.
 Chief Aquifer: Name _____ Depth to Top Aq. _____ Depth to Bot. Aq. _____
 Type of Material _____ Perm. Rating _____ Thickness _____
 Gravel Packed? Yes No Depth to Top Gr. 895 feet Depth to Bot. Gr. 1000 feet
 Supp. Aquifer _____ Depth to Top Aq. _____ Depth to Bot. Aq. _____
 Driller Eaton Drilling
 Date drilled May 22-23, 1996 Log, filed yes Open (1) Confidential (2) _____
 Equipment: Pump, type _____ Make _____
 Serial No. _____ Size of discharge pipe _____ in.
 Power, Kind _____ Make _____
 H.P. _____ Motor Serial No. _____
 Elec. Meter No. _____ Transformer No. _____
 Yield _____ GPM Pumping level _____ ft.

Water Analysis: Min. (1) San. (2) _____ H.M.(3) _____
 Water Levels Available: Yes (1) No _____
 Period of Record: Begin 07/11/96 End active
 Collecting Agency California Department of Water Resources
 Prod. Rec. (1) _____ Pump Test (2) _____ Yield (3) _____

SKETCH

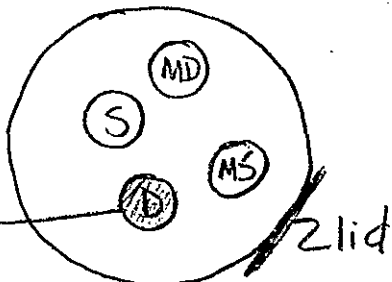

deep piezometer?
S = shallow
MS = middle - shallow
MD = middle - deep

REMARKS

This is the deep well of a quadruple-completion monitoring well.
 The shallow well is 190 feet deep, the middle-shallow well is 530 feet, and the middle-deep well is 710 feet. The four wells are separated by bentonite seals. A 1" steel air tube is attached to the well casing at 150' depth, and was used for well development. The well is located within the boundaries of RD 108 and was constructed with their permission. See attached map for location. Electric log of well is on file.

Recorded by: Naomi Kalman
 Date: 01/10/01

Location of AB 1
Nicholaus Quad



51-1068

1:7272

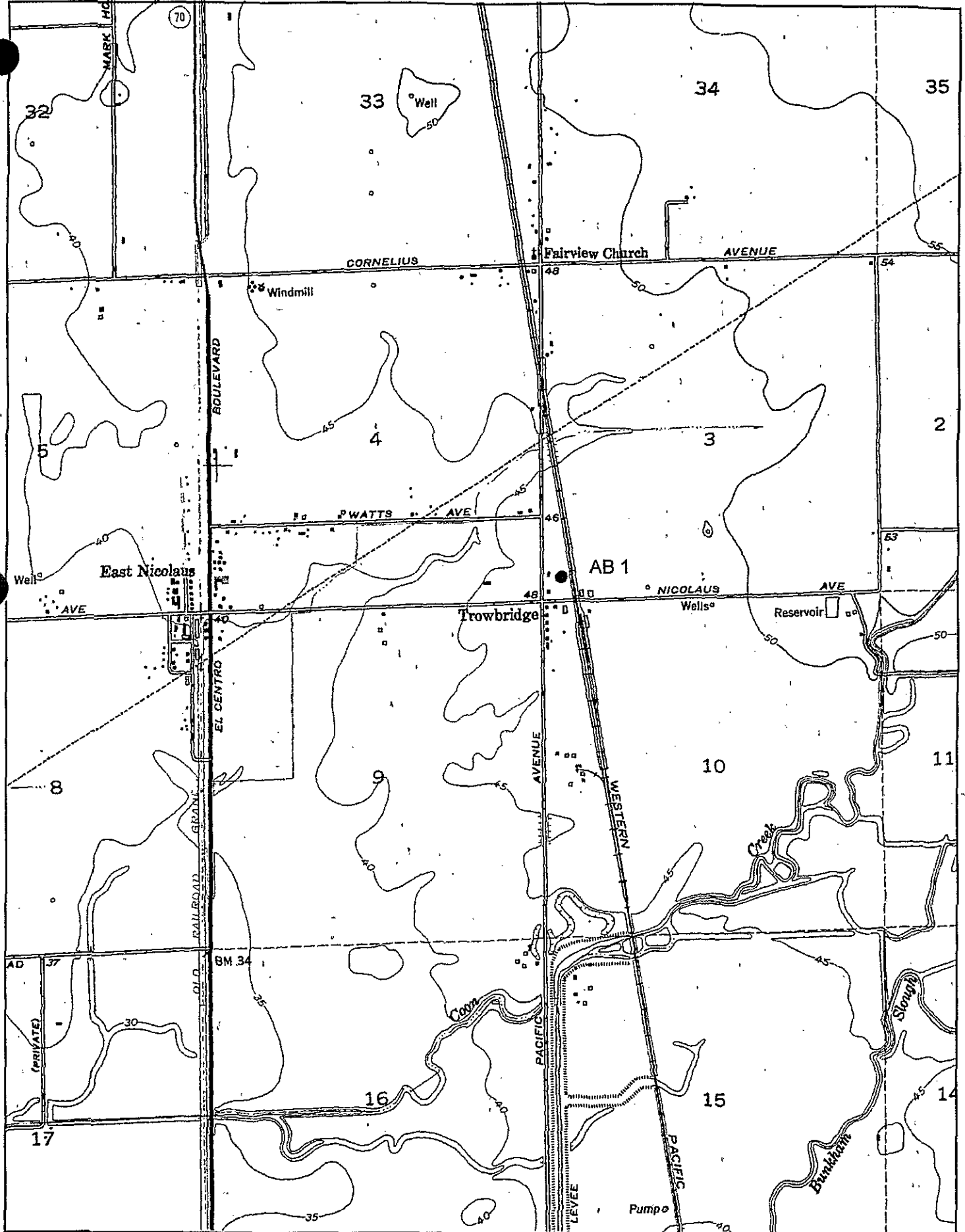

Appendix 5-B
Geologic Sections – Feather River Levees

This page intentionally left blank.

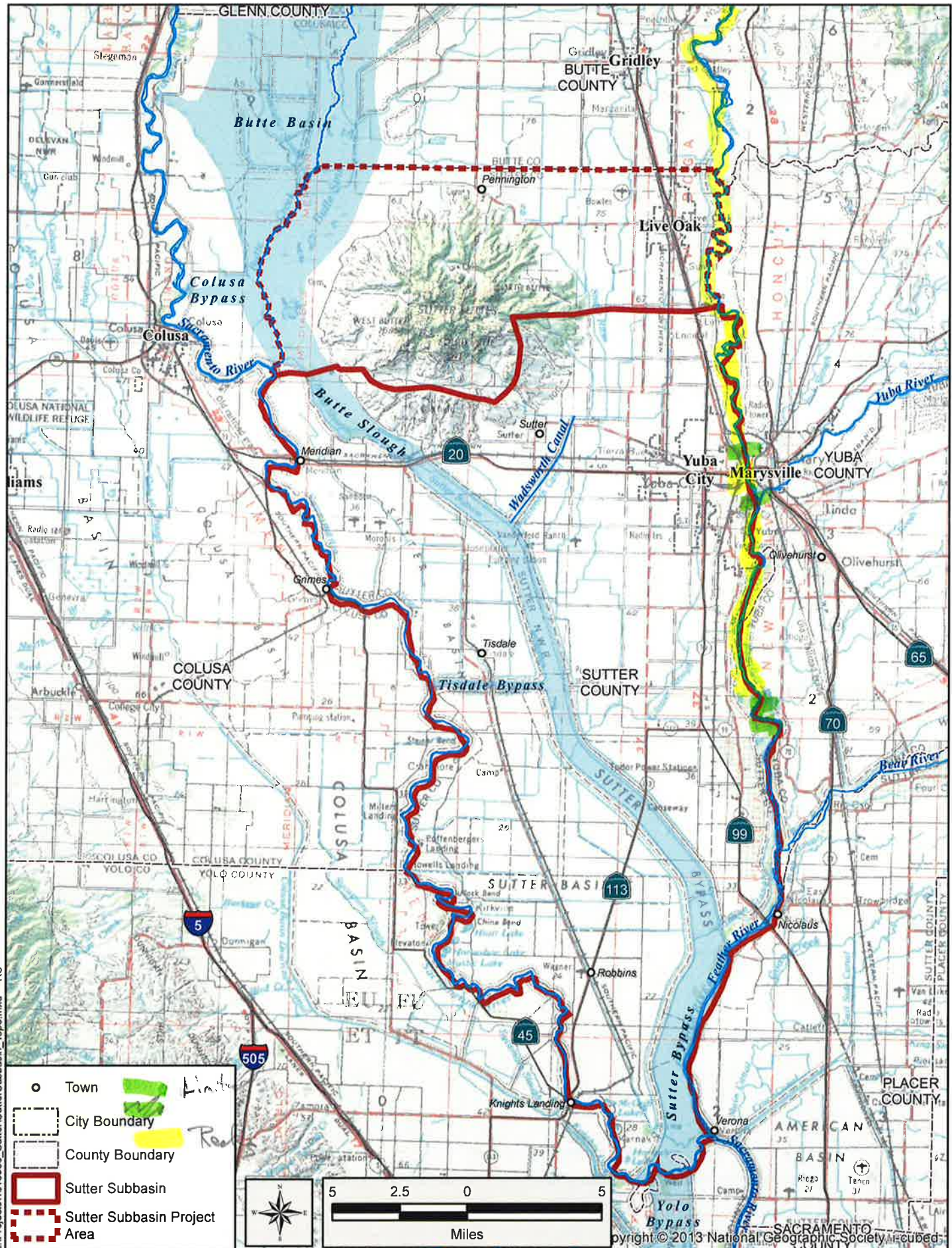

30-Sep-2016 Z:\Projects\1610508_Sutter\Subbasin_Topo.mxd RS

Project Title		Sutter Groundwater Subbasin <i>and By-Passes</i> Geology	FIGURE
Location		SEPTMBER 2016	
Client		DRAFT	

Groundwater Recharge Areas from Rivers

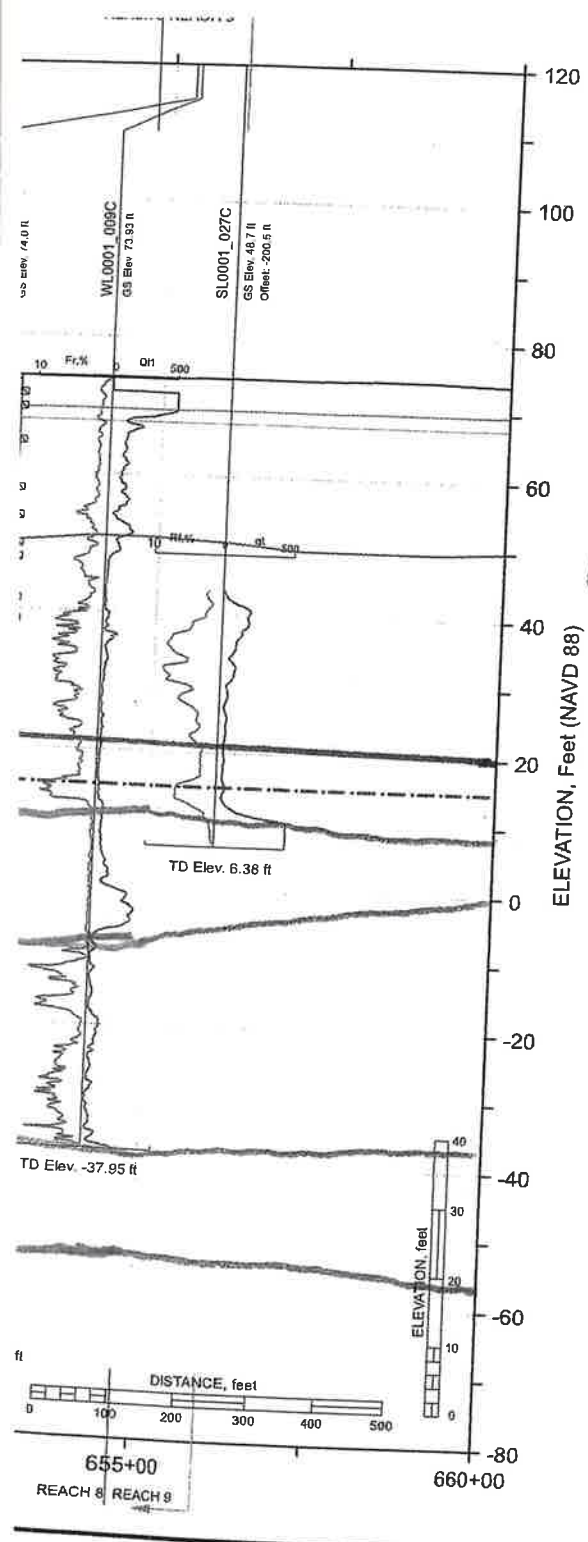

BOR 20'

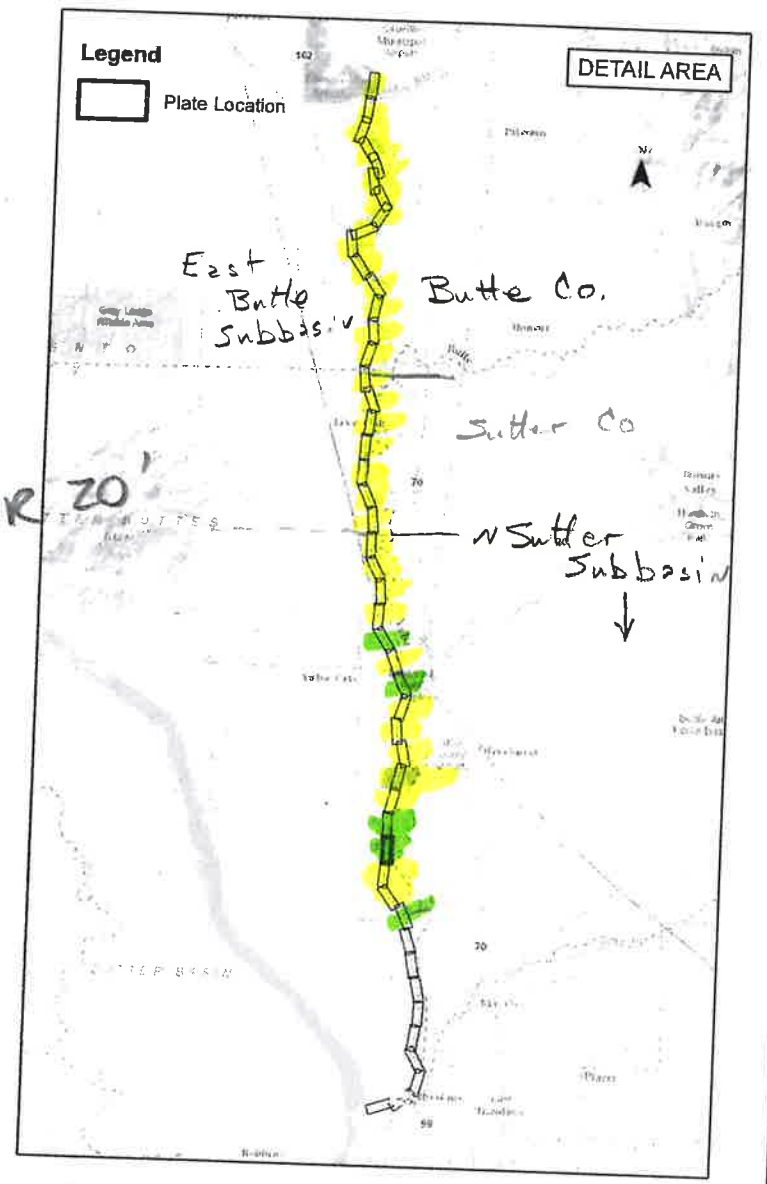

FRWL Project Plan Views and Stick Log Figures
FRWL Project: Station 610+00 to Station 660+00

	Geotechnical Design Recommendations Report	Appendix A15
	Sutter Butte Flood Control Agency FEATHER RIVER WEST LEVEE PROJECT	

~~Direct~~ Sand and Gravel opposite invert of River, not previously blocked by slurry wall
 Clay to silt opposite invert of River (pre-2013)

LEGEND FOR PLAN VIEW

EXPLORATIONS & LEVEE FEATURES

- SBFCA TO1 FRWL Project Boring
- SBFCA TO1 FRWL Project CPT
- SBFCA TO2 & TO4 FRWL Project Boring
- SBFCA TO2 & TO4 FRWL Project CPT
- Historical Boring
- Historical CPT
- Levee Miles
- SBFCA FRWL Project Levee Stationing
- Analysis Cross-Section
- Analysis Cross-Section: Sensitivity Only
- Reach
- Levee District Boundary
- Maintenance Area Boundary
- Reclamation District Boundary

EXISTING IMPROVEMENT MEASURE, KNOWN OR REPORTED

- Berm
- Ditch/Canal
- Levee Raise
- Levee Raise and Widening
- Levee Reconstruction
- *Relief Well
- Revetment
- Riprap
- Seepage Interceptor System
- Bentonite-Tire Slurry Wall
- Slurry Cutoff Wall
- Toe Drain
- Waterside Slope Repair
- Proposed Mitigation Measure (See specifics on each plate)

*Dots are not representative of actual locations of relief wells

DOCUMENTED HISTORICAL LEVEE DISTRESS

- Boil
- Cracking
- Sinkhole
- Area of Concern
- Breach, Levee Failure
- Erosion
- Seepage
- Sinkhole
- Slope Instability

LEGEND FOR STICK LOG FIGURES

PROFILE LEGEND

- Levee Crest
- Landside Levee Toe
- Ditch/Canal
- Existing Cutoff Wall (Based on As-Built Drawings)
- Existing Cutoff Wall (Based on Design Drawings)
- Proposed Mitigation Measure (See specifics on each plate)
- 1955/1957 Design Water Surface Elevation
- 200-Year Water Surface Elevation
- Analysis Cross-Section (Dashed for Sensitivity Only)

SOIL CLASSIFICATIONS

Asolite	Boulders and cobbles	Concrete	Fill	Boulders and cobbles
Fat Clay (CH)	Fat Clay with Sand (CH)	Fat Clay with Gravel (CH)	Gravelly Fat Clay (CH)	Gravelly Fat Clay with Sand (CH)
Sandy Fat Clay (CH)	Sandy Fat Clay with Gravel (CH)	Lean Clay (CL)	Lean Clay with Sand (CL)	Silty Clay (CL-ML)
Silty Clay with Sand (CL-ML)	Silty Clay with Gravel (CL-ML)	Gravelly Silty Clay (CL-ML)	Gravelly Silty Clay with Sand (CL-ML)	Sandy Silty Clay (CL-ML)
Sandy Silty Clay with Gravel (CL-ML)	Lean to Fat Clay (CL-ML)	Lean to Fat Clay with Gravel (CL-ML)	Lean to Fat Clay with Sand (CL-ML)	Gravelly Lean to Fat Clay (CL-ML)
Chronically Lean to Fat Clay with Sand (CL-CH)	Sandy Lean to Fat Clay (CL-CH)	Sandy Lean to Fat Clay with Gravel (CL-CH)	Silty Clay to Clayey Silt (CL-MH)	Silty Clay to Clayey Silt with Sand (CL-MH)
Silty Clay to Clayey Silt with Gravel (CL-MH)	Gravelly Silty Clay to Clayey Silt (CL-MH)	Gravelly Silty Clay to Clayey Silt with Sand (CL-MH)	Sandy Silty Clay to Clayey Silt (CL-MH)	Sandy Silty Clay to Clayey Silt with Gravel (CL-MH)
Lean Clay with Gravel (CL)	Gravelly Lean Clay (CL)	Gravelly Lean Clay with Sand (CL)	Sandy Lean Clay (CL)	Sandy Lean Clay with Gravel (CL)
Clayey Gravel (GC)	Silty, Clayey Gravel (GC-GM)	Silty, Clayey Gravel with Sand (GC-GM)	Clayey Gravel with Sand (GC)	Silty Gravel (GM)
Silty Gravel with Sand (GM)	Poorly Graded Gravel (GP)	Poorly Graded Gravel with Sand (GP)	Poorly Graded Gravel with Clay and Sand (GP-GC)	Poorly Graded Gravel with Silt (GP-GM)
Poorly Graded Gravel with Silt and Sand (GP-GM)	Poorly Graded Gravel with Sand (GP)	Well-Graded Gravel (GW)	Well-Graded Gravel with Clay (GW-GC)	Well-Graded Gravel with Clay and Sand (GW-GC)
Well-Graded Gravel with Silt and Sand (GW-GM)	Well-Graded Gravel with Silt and Sand (GW-GM)	Well-Graded Gravel with Sand (GW)	Elastic Silt (MH)	Elastic Silt with Sand (MH)
Elastic Silt with Gravel (MH)	Gravelly Elastic Silt (MH)	Gravelly Elastic Silt with Sand (MH)	Sandy Elastic Silt (MH)	Sandy Elastic Silt with Gravel (MH)
Silt (ML)	Silt with Sand (ML)	Clayey Silt (ML/CL)	Clayey Silt with Sand (ML/CL)	Clayey Silt with Gravel (ML/CL)
Chronically Clayey Silt (ML/CL)	Gravelly Clayey Silt with Sand (ML/CL)	Sandy Clayey Silt (ML/CL)	Sandy Clayey Silt with Gravel (ML/CL)	Silt with Gravel (ML)
Gravelly Silt (ML)	Gravelly Silt with Sand (ML)	Sandy Silt (ML)	Sandy Silt with Gravel (ML)	Organic Fat Clay (OH)
Organic Fat Clay with Sand (OH)	Organic Fat Clay with Gravel (OH)	Gravelly Organic Fat Clay (OH)	Gravelly Organic Fat Clay with Sand (OH)	Sandy Organic Fat Clay (OH)
Sandy Organic Fat Clay with Gravel (OH)	Organic Elastic Silt (OH)	Organic Elastic Silt with Sand (OH)	Organic Elastic Silt with Gravel (OH)	Gravelly Organic Elastic Silt (OH)
Channel Organic Elastic Silt with Sand (OH)	Sandy Organic Elastic Silt (OH)	Sandy Organic Elastic Silt with Gravel (OH)	Organic Lean Clay (CL)	Organic Lean Clay with Sand (CL)
Organic Lean Clay with Gravel (CL)	Gravelly Organic Lean Clay (CL)	Gravelly Organic Lean Clay with Sand (CL)	Sandy Organic Lean Clay (CL)	Sandy Organic Lean Clay with Gravel (CL)
Organic Silt (OL)	Organic Silt with Sand (OL)	Organic Silt with Gravel (OL)	Gravelly Organic Silt (OL)	Gravelly Organic Silt with Sand (OL)
Sandy Organic Silt (OL)	Sandy Organic Silt with Gravel (OL)	Peat (PT)	Clayey Sand (SC)	Silty, Clayey Sand (SC-SM)
Silty, Clayey Sand with Gravel (SC-SM)	Clayey Sand with Gravel (SC)	Silty Sand (SM)	Silty Sand with Gravel (SM)	Poorly Graded Sand (SP)
Poorly Graded Sand with Clay (SP-SC)	Poorly Graded Sand with Clay and Gravel (SP-SC)	Poorly Graded Sand with Silt (SP-SM)	Poorly Graded Sand with Silt and Gravel (SP-SM)	Poorly Graded Sand with Silt and Gravel (SP)
Well-Graded Sand (SW)	Well-Graded Sand with Clay (SW-SC)	Well-Graded Sand with Clay and Gravel (SW-SC)	Well-Graded Sand with Silt (SW-SM)	Well-Graded Sand with Silt and Gravel (SW-SM)
Well-Graded Sand with Gravel (SW)				

ASSIGNMENT OF BORING ID NUMBER

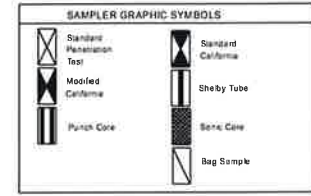
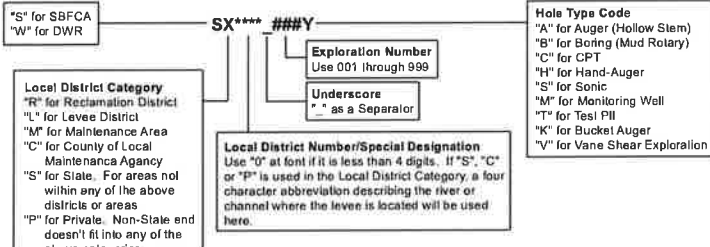

NOTE:
Some historical locations may not have stick figures in the profile view due to:
1. Incomplete data.
2. Available exploration on the plans and stick logs show comparable stratigraphy as historical explorations and are therefore not included due to limited space. However, all historical explorations are included in the GDR.

SURFICIAL GEOLOGY LEGEND (Source: DWR, 2010a)

- Surficial Geology was mapped at 1:20,000.
- W 1911 Water bodies, circa 1911
 - W 1937 Water bodies, circa 1937
 - BP Borehole pits present in 1937

GEOLOGIC UNITS*

Historical	Holocene	Pleistocene	Pliocene / Pleistocene
L: Levee; Culturally deposited	Hob: Overbank deposits; sand, silt, and clay; deposited during high-stage water flow, overtopping channel banks	Qmu: Modesto Formation; upper member; Unconsolidated gravel, sand, silt, and clay	Qpl: Tuff breccia; Volcanic tuff breccia (andesitic and rhyolitic) from Sutter Buttes, latest Pliocene
SP: Spoils pile; Artificial fill, circa 1937	Hcs: Cravasse splay deposits; Fine to coarse sand, with minor lenses of clay deposited from breaching of natural or artificial levees	Qmi: Modesto Formation; lower member; Unconsolidated to semi-consolidated gravel, sand, silt and clay	
DT: Dredge tailings; Spoils material from gold dredge operations	Hdf: Distributary fan deposits; Sand, silt and clay	Qru: Riverbank Formation; upper member; Semi-consolidated to consolidated gravel, sand, silt and minor clay	
Rob: Overbank deposits; sand, silt, and clay; deposited during high-stage water flow, overtopping channel banks	Hofc: Overflow channels; Vertically stratified sand, silt and clay in channels occupied when high-stage water overtops channel banks	Qrl: Riverbank Formation; lower member; Consolidated gravel, sand, silt, and clay, generally associated with a strong dunpan soil horizon	
Rcs: Cravasse splay deposits; Fine to coarse sand, with minor lenses of clay deposited from breaching of natural or artificial levees	Ha: Alluvial deposits undifferentiated; Sand, silt, and minor lenses of gravel; under cultivation in 1937		
Rdf: Distributary fan deposits; Sand, silt and clay	Hch: Channel deposits; Sorted sands and silts; lying upward		
Rdc: Distributary channel deposits; Distributary channel deposits; trace gravel, sand, silt, and clay; channelized flow conducting sediment to floodplain	Hb: Channel bar deposits; Fine gravel, sand, and silt deposited in or along channel lateral margins		
Rofa: Overflow channels; Vertically stratified sand, silt and clay in channels occupied when high-stage water overtops channel banks	Hms: Channel meander scot deposits; Sand, silt and clay from lateral channel migration		
Rsl: Slough deposits; Sand, silt and clay; lying upward facies; low-energy channel deposit	Hdc: Distributary channel deposits; sand, silt, and clay		
Rcu: Cravasse splay deposits; Cut off channel (chula); occurs on insides of meander bends with in the river channel; on flood plain - attachment of overflow channels into hydraulic mining debris	Hsi: Slough deposits; sand, silt and clay; lying upward facies; low-energy channel deposit		
Rch: Channel deposits; Sorted sands and silts; lying upward (Rich 1911; channels as shown on historic topo)	Hfy: Alluvial fan deposits; Well graded gravel, sand, silt and clay; volcanic lithologies		
Rb: Channel bar deposits; fine gravel, sand, and silt deposited in or along channel lateral margins	Qa: Alluvial deposits undifferentiated; Sand, silt, and minor lenses of fine gravel, under urbanization in 1937		
Rms: Channel meander scot deposits; Sand, silt and clay from lateral channel migration	Qn: Basin deposits; Fine sand, silt and clay, dark yellow to dark yellowish brown, under cultivation in 1937		
Ra: Alluvial deposits, undifferentiated; sand, silt, and minor lenses of fine gravel	Qo: Marsh deposits; Silt and clay, likely organic rich; perennially or seasonally submerged		

Boring Information

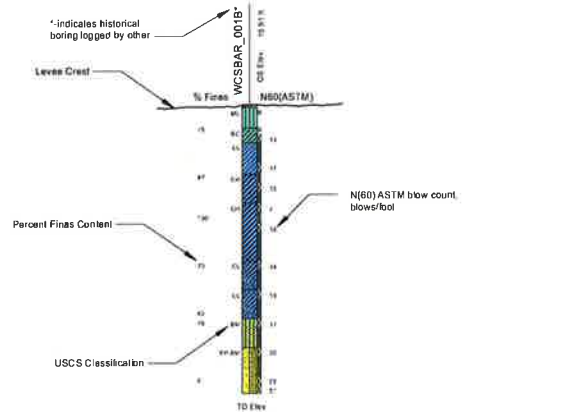

CPT Information

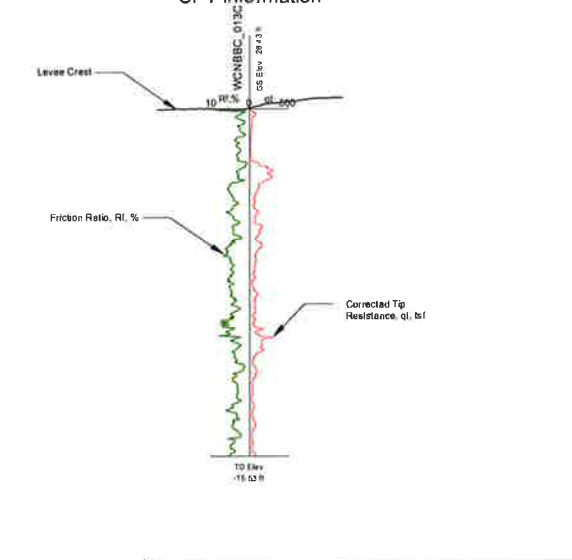

FRWL Project Plan Views and Stick Log Figures

Plate Legend

URS
Geotechnical Design
Recommendations Report

Sutter Butte Flood Control Agency
FEATHER RIVER WEST LEVEE PROJECT

Appendix A2

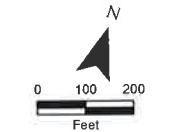

1 inch equals 200 feet

- NOTES:
1. These Plan and Profile plates were adapted from Sutter Butte Flood Control Agency (SBFCA) Geotechnical Design Recommendation Report (GDRR) Plan and Profile Plates.
 2. Elevations of levee crown, landside toe, and ditch inverts are approximate.
 3. Historical borings in the profile are denoted by an asterisk (*) after the boring name. Historical boring locations and profiles are based on available information. Some historic explorations are shown on the plan but not in the profile.
 4. Historical exploration symbols may represent a boring, CPT, or other exploration type.
 5. Refer to the preceding P1GDR and/or SGDR for the Sutter Study Area and SBFCA GDR for a full understanding of the historical exploration information and data to assist with interpreting the information within this GER.
 6. USCS classification labels are not presented on the profiles for soil lenses (thickness less than 1.5 ft).
 7. Where multiple exploration symbols overlap, see labels for clarification.
 8. The information provided in these Plan and Profile plates has been compiled from a variety of sources. The URS team does not attest to the accuracy, completeness, or reliability of geotechnical exploration and other subsurface data by others that are included or referenced in these plates.

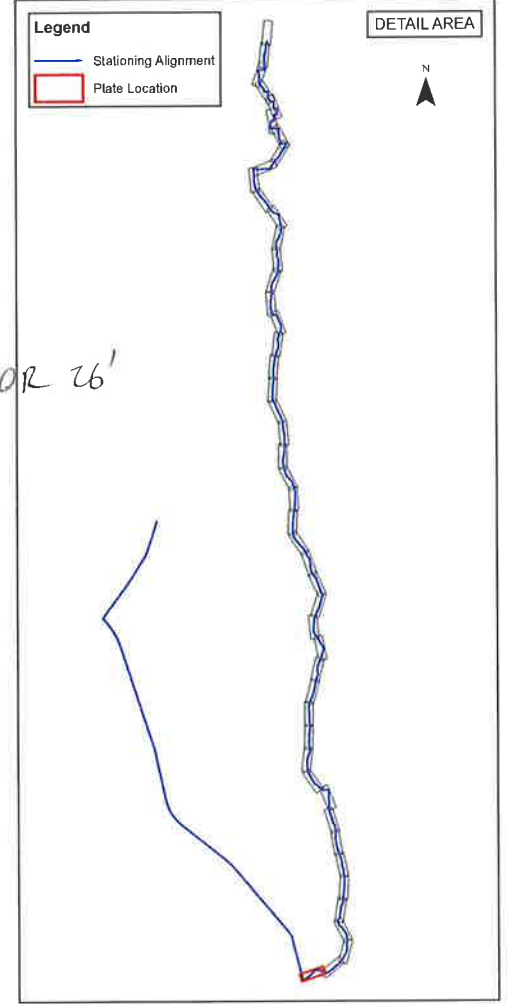
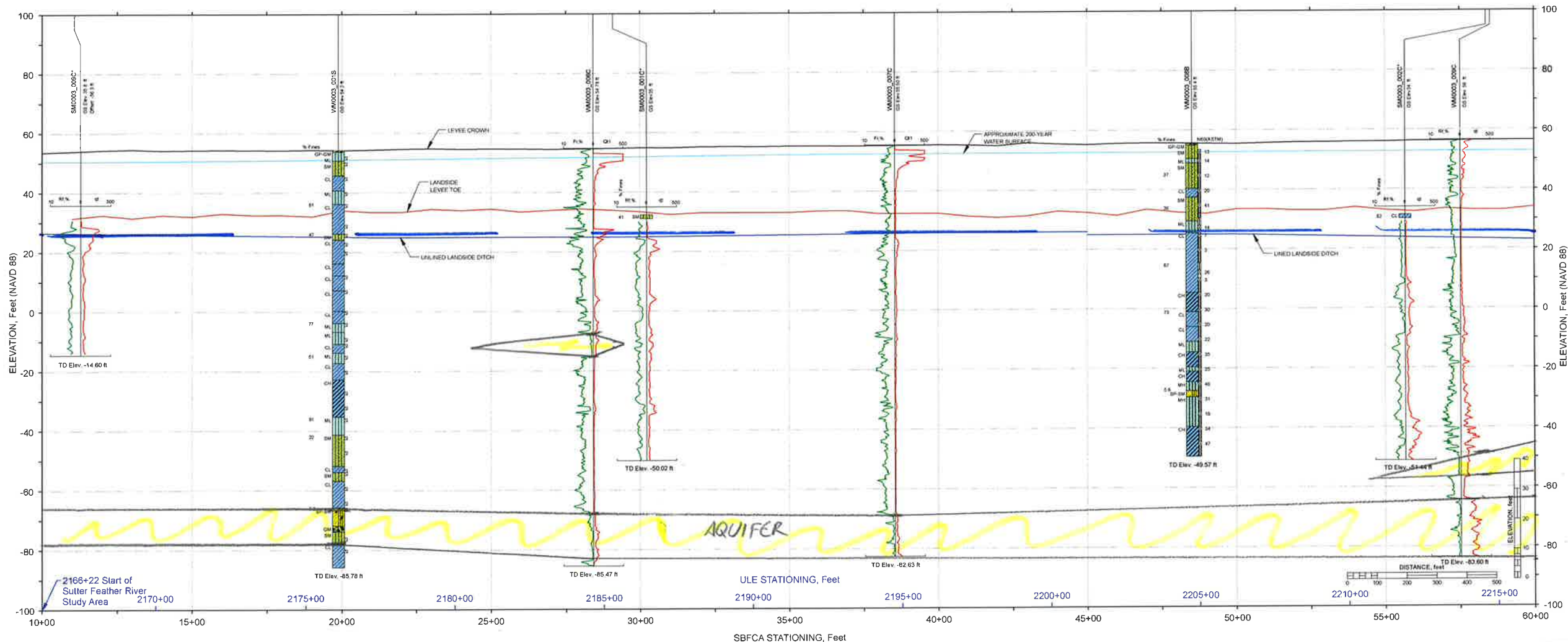

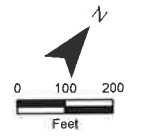
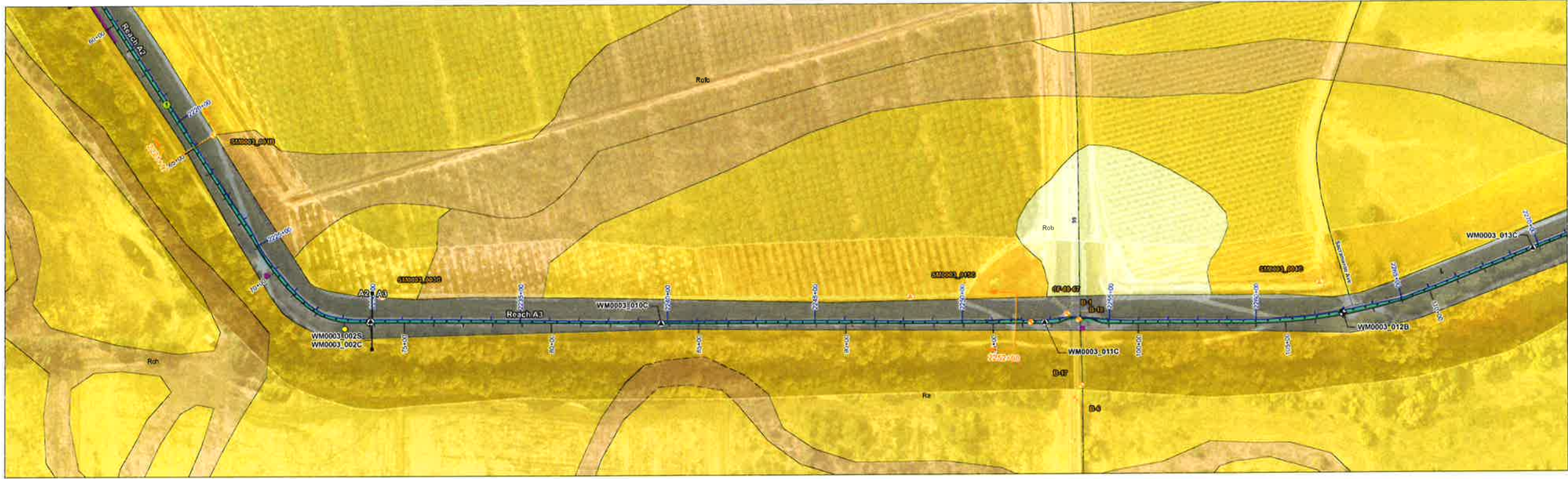

1 inch equals 200 feet

- NOTES:
1. These Plan and Profile plates were adapted from Sutter Butte Flood Control Agency (SBFCA) Geotechnical Design Recommendation Report (GD RR) Plan and Profile Plates.
 2. Elevations of levee crown, landside toe, and ditch inverts are approximate.
 3. Historical borings in the profile are denoted by an asterisk (*) after the boring name. Historical boring locations and profiles are based on available information. Some historic explorations are shown on the plan but not in the profile.
 4. Historical exploration symbols may represent a boring, CPT, or other exploration type.
 5. Refer to the preceding P1GDR and/or SGDR for the Sutter Study Area and SBFCA GDR for a full understanding of the historical exploration information and data to assist with interpreting the information within this GER.
 6. USCS classification labels are not presented on the profiles for soil lenses (thickness less than 1.5 ft).
 7. Where multiple exploration symbols overlap, see labels for clarification.
 8. The information provided in these Plan and Profile plates has been compiled from a variety of sources. The URS team does not attest to the accuracy, completeness, or reliability of geotechnical exploration and other subsurface data by others that are included or referenced in these plates.

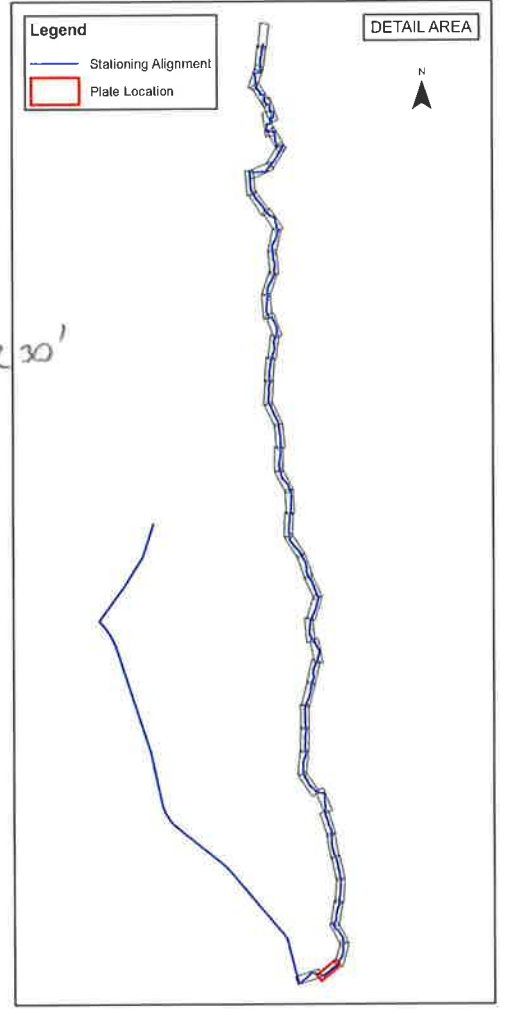
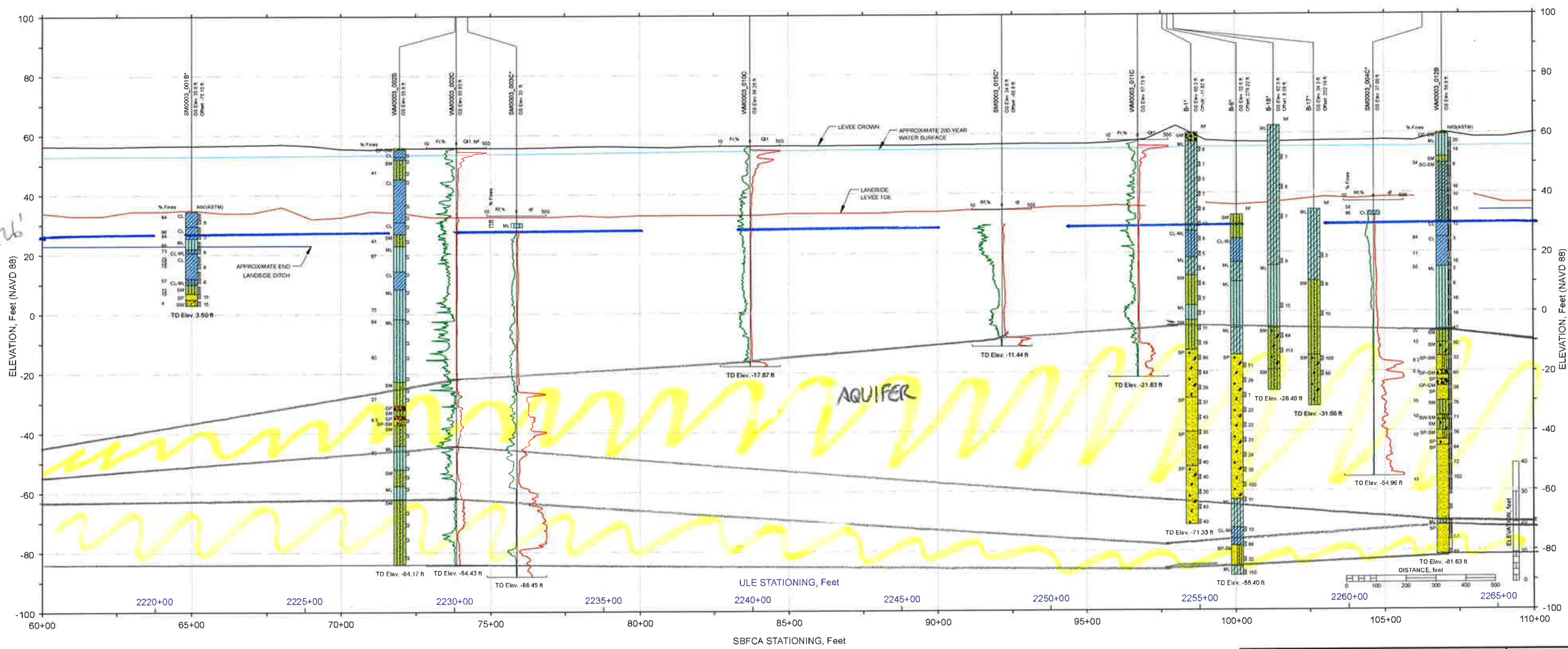

BOR 26'

BOR 30'

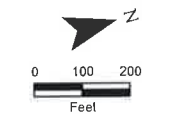
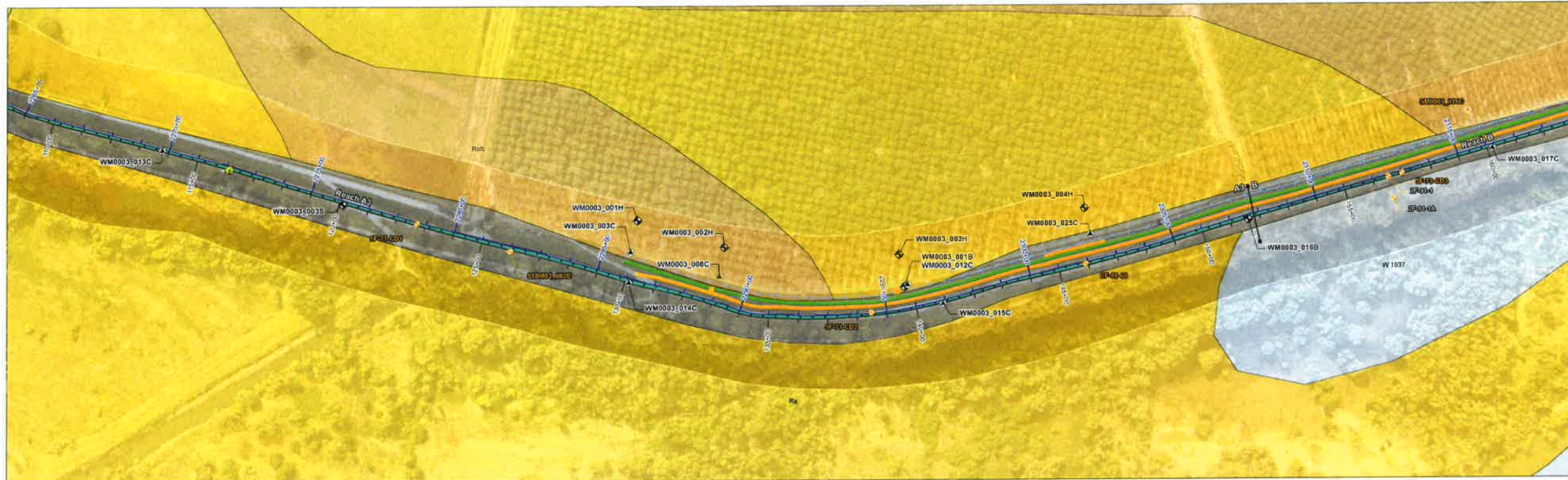

1 inch equals 200 feet

- NOTES:
1. These Plan and Profile plates were adapted from Sutter Butte Flood Control Agency (SBFCA) Geotechnical Design Recommendation Report (GDRR) Plan and Profile Plates.
 2. Elevations of levee crown, landside toe, and ditch inverts are approximate.
 3. Historical borings in the profile are denoted by an asterisk (*) after the boring name. Historical boring locations and profiles are based on available information. Some historic explorations are shown on the plan but not in the profile.
 4. Historical exploration symbols may represent a boring, CPT, or other exploration type.
 5. Refer to the preceding P1GDR and/or SGDR for the Sutter Study Area and SBFCA GDR for a full understanding of the historical exploration information and data to assist with interpreting the information within this GER.
 6. USCS classification labels are not presented on the profiles for soil lenses (thickness less than 1.5 ft).
 7. Where multiple exploration symbols overlap, see labels for clarification.
 8. The information provided in these Plan and Profile plates has been compiled from a variety of sources. The URS team does not attest to the accuracy, completeness, or reliability of geotechnical exploration and other subsurface data by others that are included or referenced in these plates.

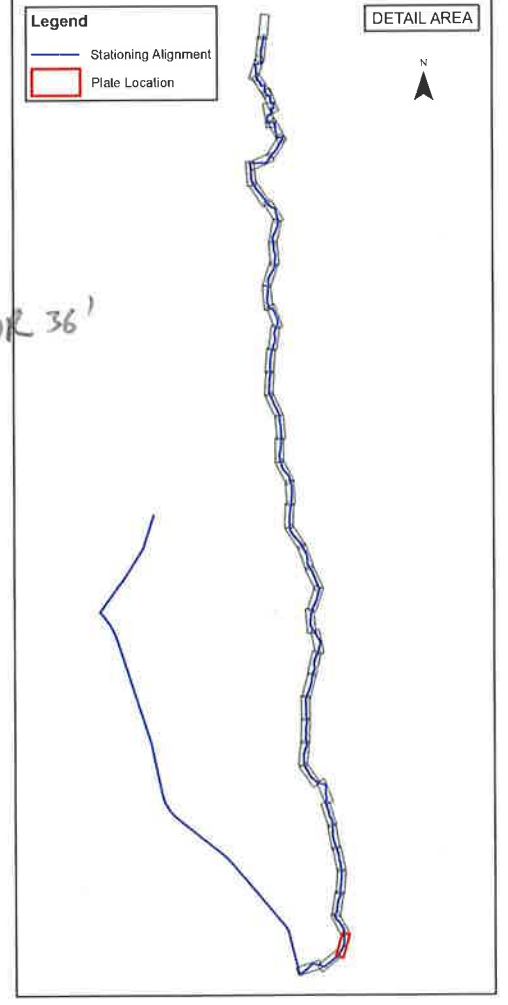
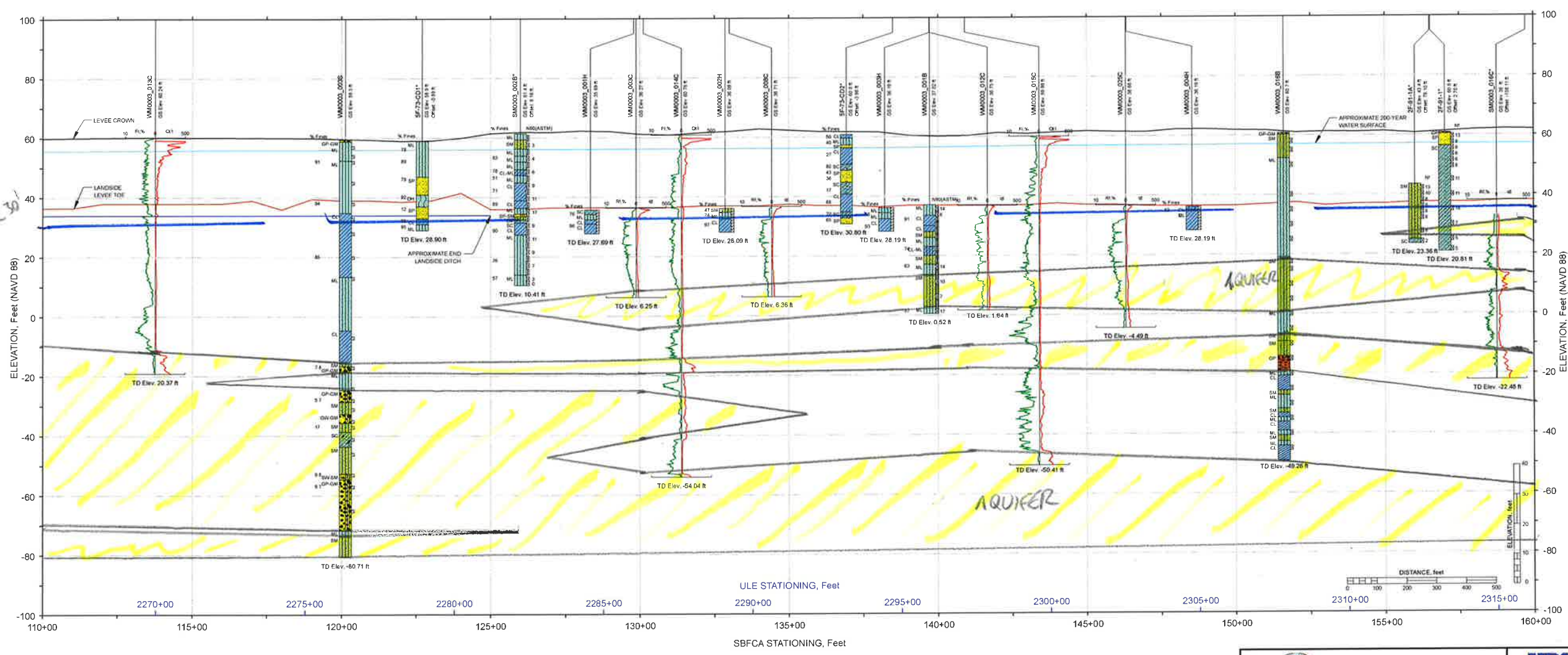

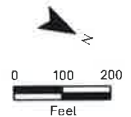
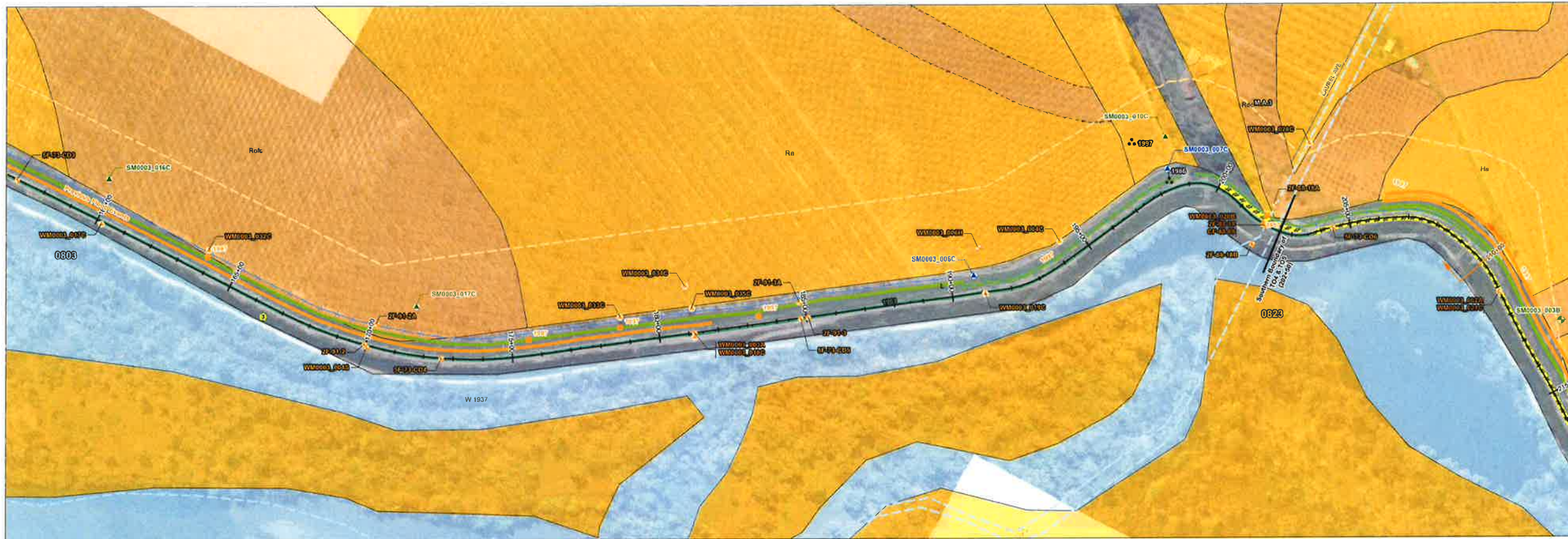

- NOTES:
- Elevations of levee crown and landslide toe are approximate. These elevations were obtained from DWR CVFED or ULE LIDAR data and used for geotechnical analyses and report purpose only. For detail crown elevation and landslide toe information, please refer to the FRWL Project civil drawings.
 - The water surface elevations are based on information provided by Peterson Brusard, Inc. in their July 25, 2012 report entitled "Design Water Surface Profiles for the Feather River West Levee Rehabilitation Project Addendum #1".
 - Locations of explorations are approximate. Stick logs represent general soil conditions encountered at the time of exploration. For more detailed information on the materials encountered, refer to boring and CPT logs in the Geotechnical Data Report for the FRWL Project. No warranty is provided regarding the continuity of soil conditions between individual explorations.
 - When reported, $N_{60}(ASTM)$ refers to $N_{60}(ASTM) = N_{60} \times \text{Hammer Efficiency } (\%)$. See Geotechnical Data Report for the FRWL Project for hammer efficiency data for individual borings.
 - These drawings do not include all historical explorations on the profile view. Historical explorations from the DWR ULE project are shown; "other" historical explorations are identified by an asterisk (*) in the exploration ID. For these "other" historical borings, blow counts are field blow counts (NF) and USCS classifications are visual classifications.
 - USCS classification labels are not presented on the stick logs for soil lenses (thickness less than 1.5 feet).
 - This is a color figure. Black and white reproduction should not be relied upon as data will be lost.
 - To prevent scale distortion, this map should be printed on a "D" size sheet (22x34 inches).
 - Surficial geology was mapped at 1:20,000 scale. (Source: SGRD for DWR ULE Project, URS, 2010).
 - The information provided in these plans and stick-log plates has been compiled from a variety of sources. URS does not attest to the accuracy, completeness, or reliability of geotechnical exploration and other subsurface data by others that are included or referenced in these plates.
 - These plans and stick-log plates are for the use and benefit of HDR, SBFCA, and their consultants in connection with the execution of the FRWL Project. Use by any other party is at their own discretion and risk. These figures should not to be used as the sole basis for design, construction, remedial action, or major capital spending decisions.
 - The canalkitch elevations are approximate. These elevations were estimated from the topography.

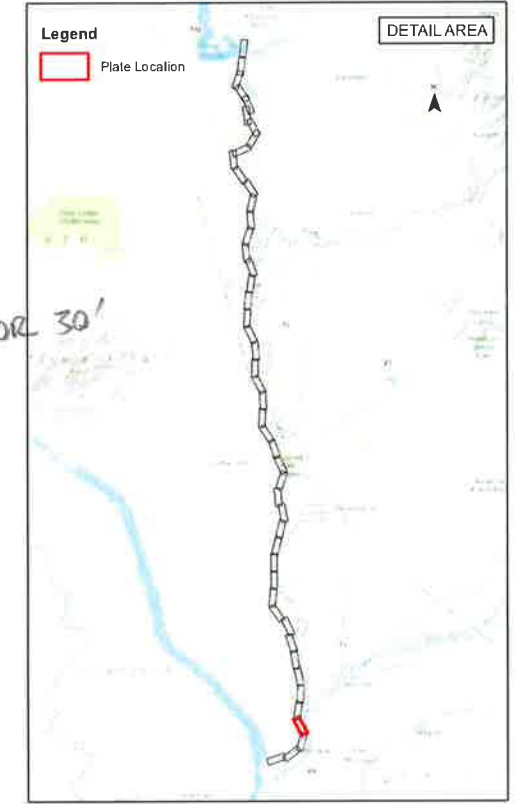
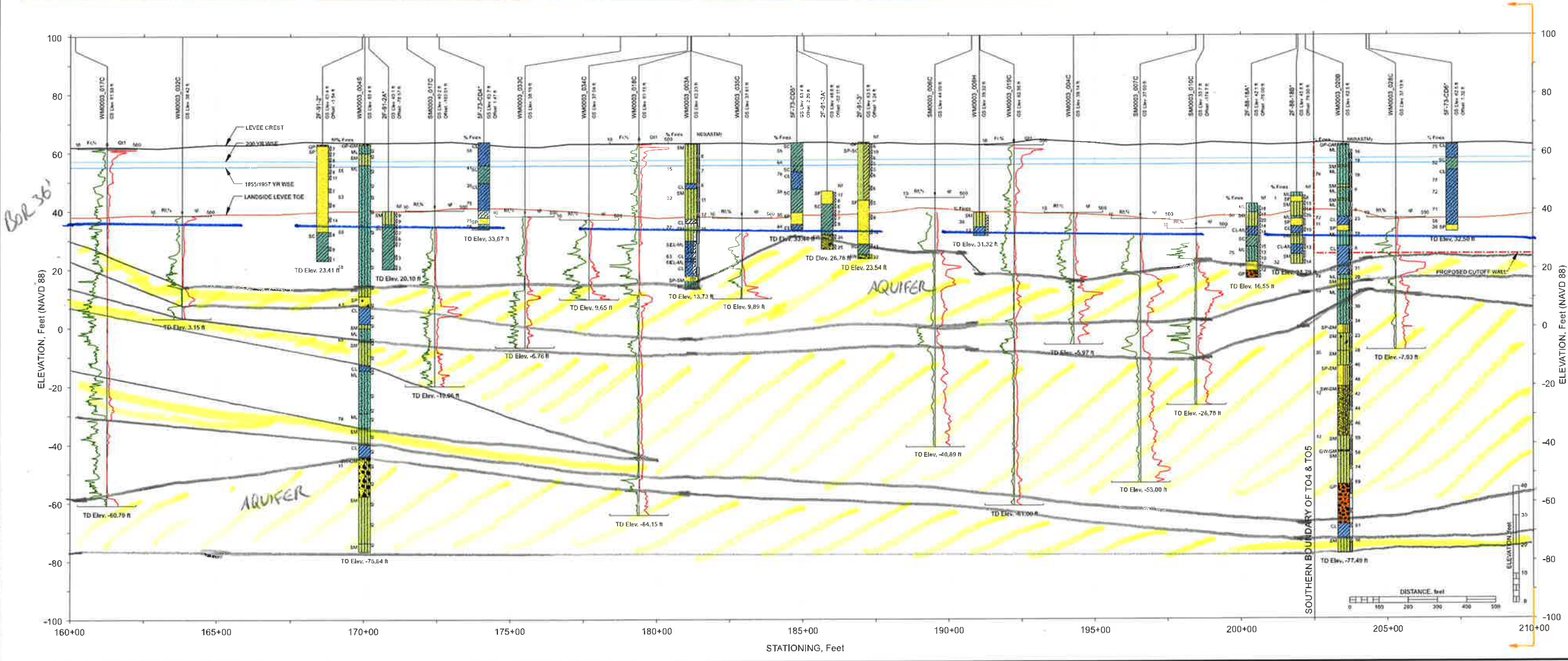

FRWL Project Plan Views and Stick Log Figures
FRWL Project: Station 160+00 to Station 210+00

URS
Geotechnical Design
Recommendations Report

Sutter Butte Flood Control Agency
FEATHER RIVER WEST LEVEE PROJECT

Appendix
A6

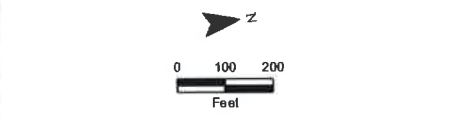
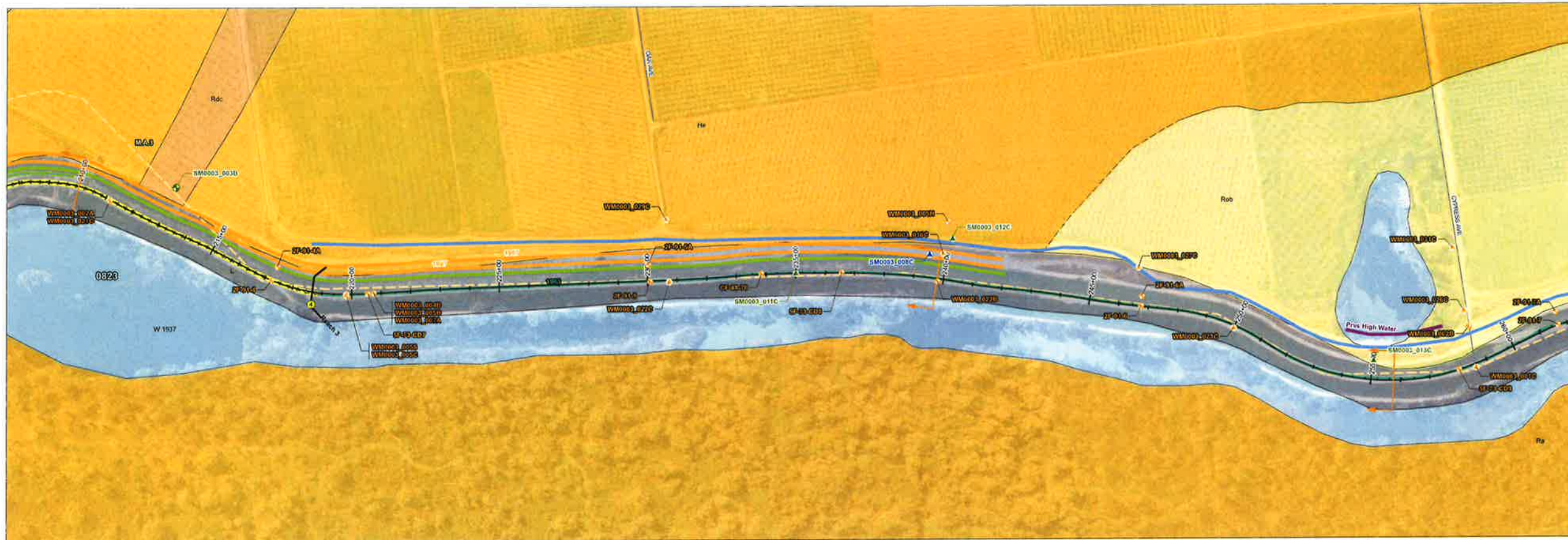

- NOTES:
1. Elevations of levee crown and landside toe are approximate. These elevations were obtained from DWR CVFED or ULE LIDAR data and used for geotechnical analyses and report purpose only. For detail crown elevation and landside toe information, please refer to the FRWL Project civil drawings.
 2. The water surface elevations are based on information provided by Peterson Brustad, Inc. in their July 26, 2012 report entitled "Design Water Surface Profiles for the Feather River West Levee Rehabilitation Project Addendum #1".
 3. Locations of explorations are approximate. Slick logs represent general soil conditions encountered at the time of exploration. For more detailed information on the materials encountered, refer to boring and CPT logs in the Geotechnical Data Report for the FRWL Project. No warranty is provided regarding the continuity of soil conditions between individual explorations.
 4. When reported, $N_{60}(ASTM)$, refers to $N_{60}(ASTM) = N_{60} \times \text{Hemmer Efficiency } (\%)$. See Geotechnical Data Report for the FRWL Project for hemmer efficiency data for individual borings.
 5. These drawings do not include all historical explorations on the profile view. Historical explorations from the DWR ULE project are shown; "other" historical explorations are identified by an asterisk (*) in the exploration ID. For these "other" historical borings, blow counts are field blow counts (NF) and USCS classifications are visual classifications.
 6. USCS classification labels are not presented on the slick logs for soil lenses (thickness less than 1.5 feet).
 7. This is a color figure. Black and white reproduction should not be relied upon as data will be lost.
 8. To prevent scale distortion, this map should be printed on a "D" size sheet (22x34 inches).
 9. Surficial geology was mapped at 1:20,000 scale. (Source: SGRD for DWR ULE Project, URS, 2010).
 10. The information provided in these plans and slick-log plates has been compiled from a variety of sources. URS does not attest to the accuracy, completeness, or reliability of geotechnical exploration and other subsurface data by others that are included or referenced in these plates.
 11. These plans and slick-log plates are for the use and benefit of HDR, SBFA, and their consultants in connection with the execution of the FRWL Project. Use by any other party is at their own discretion and risk. These figures should not be used as the sole basis for design, construction, remedial action, or major capital spending decisions.
 12. The canal/ditch elevations are approximate. These elevations were estimated from the topography.

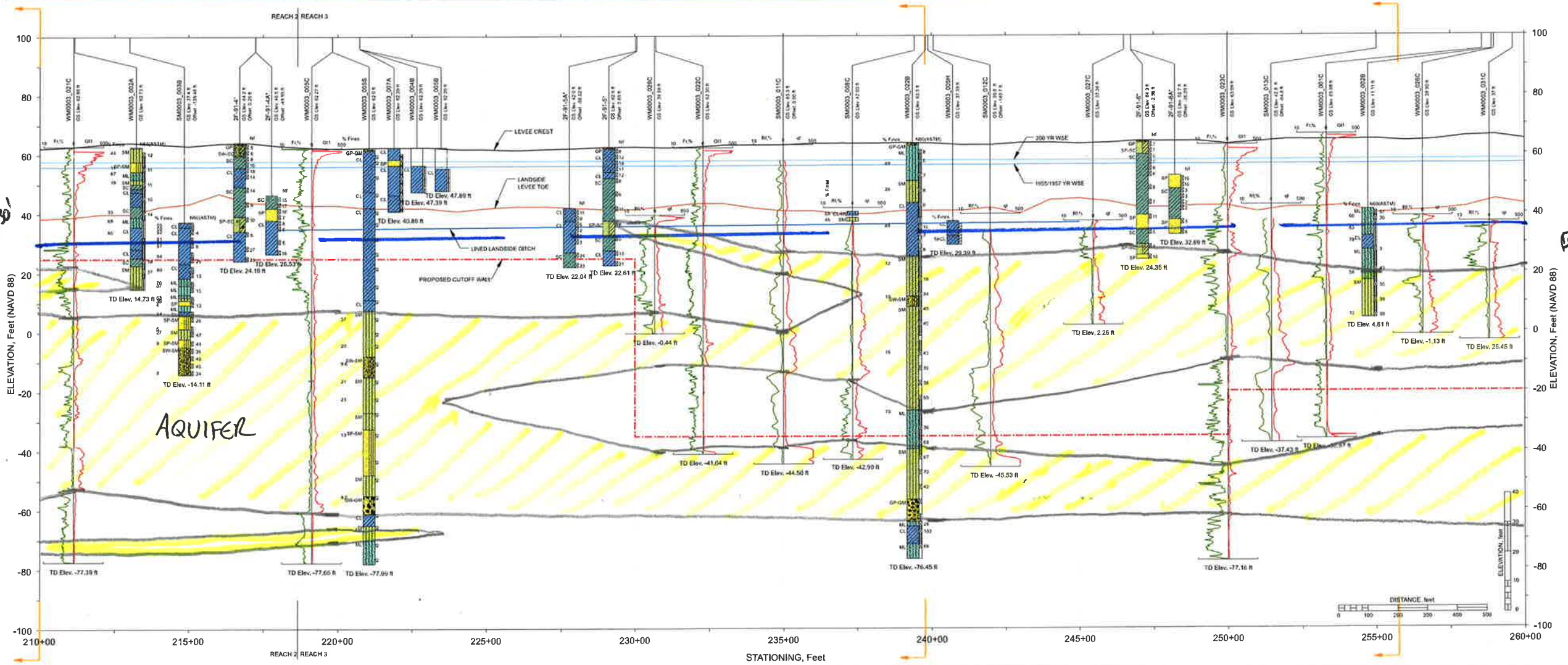

FRWL Project Plan Views and Stick Log Figures
FRWL Project, Station 210+00 to Station 260+00

URS
Geotechnical Design
Recommendations Report

Sutter Butte Flood Control Agency
FEATHER RIVER WEST LEVEE PROJECT

Appendix
A7

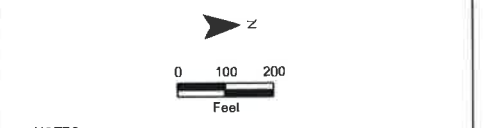
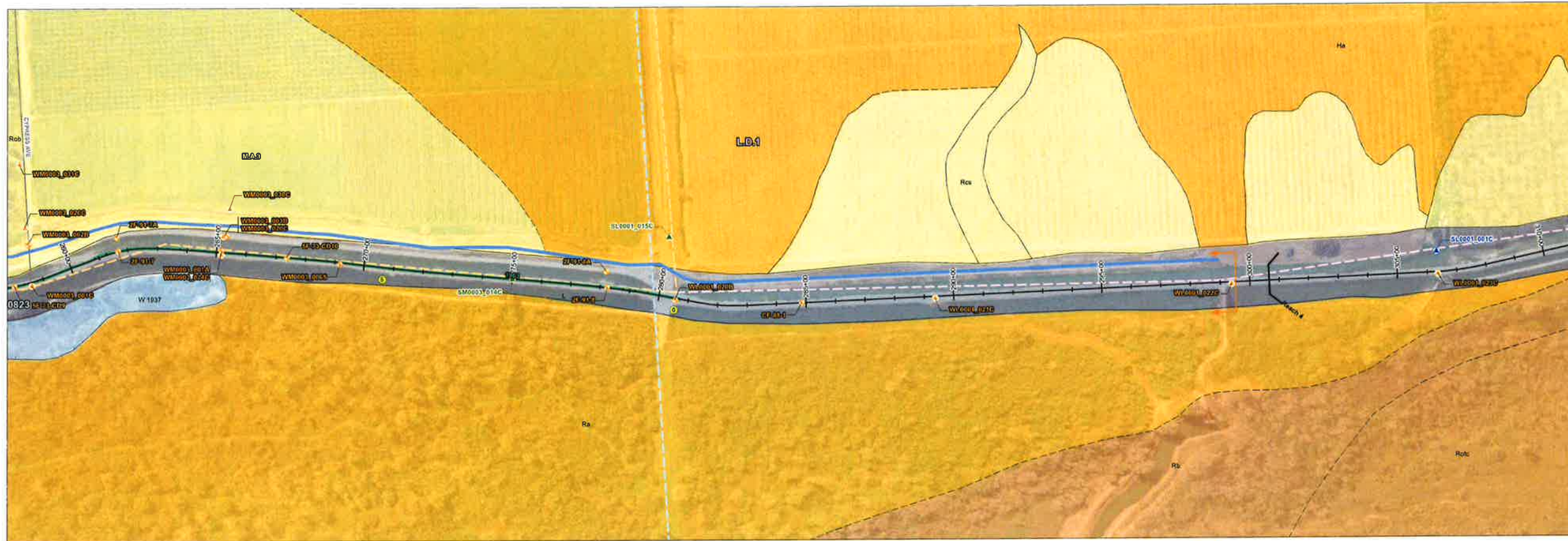

- NOTES:
- Elevations of levee crown and landside toe are approximate. These elevations were obtained from DWR CVFED or ULE LIDAR data and used for geotechnical analyses and report purpose only. For detail crown elevation and landside toe information, please refer to the FRWL Project civil drawings.
 - The water surface elevations are based on information provided by Peferson Bruslad, Inc. in their July 26, 2012 report entitled "Design Water Surface Profiles for the Feather River West Levee Rehabilitation Project Addendum #1".
 - Locations of explorations are approximate. Stick logs represent general soil conditions encountered at the time of exploration. For more detailed information on the materials encountered, refer to boring and CPT logs in the Geotechnical Data Report for the FRWL Project. No warranty is provided regarding the continuity of soil conditions between individual explorations.
 - When reported, $N_{60}(ASTM)$, refers to $N_{60}(ASTM) = N_{60} + \text{Hammer Efficiency} (\%)$. See Geotechnical Data Report for the FRWL Project for hammer efficiency data for individual borings.
 - These drawings do not include all historical explorations on the profile view. Historical explorations from the DWR ULE project are shown; "other" historical explorations are identified by an asterisk (*) in the exploration ID. For these "other" historical borings, blow counts are field blow counts (NF) and USCS classifications are visual classifications.
 - USCS classification labels are not presented on the stick logs for soil lenses (thickness less than 1.5 feet).
 - This is a color figure. Black and white reproduction should not be relied upon as data will be lost.
 - To prevent scale distortion, this map should be printed on a "D" size sheet (22x34 inches).
 - Surficial geology was mapped at 1:20,000 scale. (Source: SGDR for DWR ULE Project, URS, 2010).
 - The information provided in these plans and stick-log plates has been compiled from a variety of sources. URS does not attest to the accuracy, completeness, or reliability of geotechnical exploration and other subsurface data by others that are included or referenced in these plates.
 - These plans and stick-log plates are for the use and benefit of HDR, SBFCA, and their consultants in connection with the execution of the FRWL Project. Use by any other party is at their own discretion and risk. These figures should not be used as the sole basis for design, construction, remedial action, or major capital spending decisions.
 - The canal/ditch elevations are approximate. These elevations were estimated from the topography.

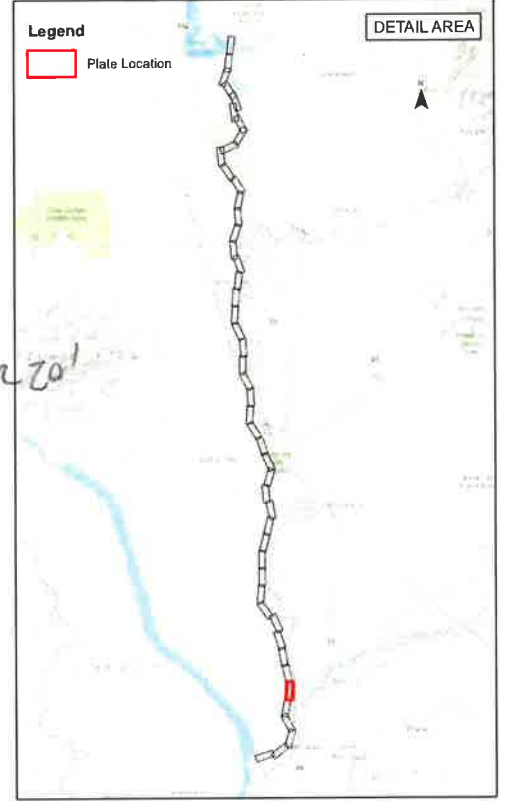
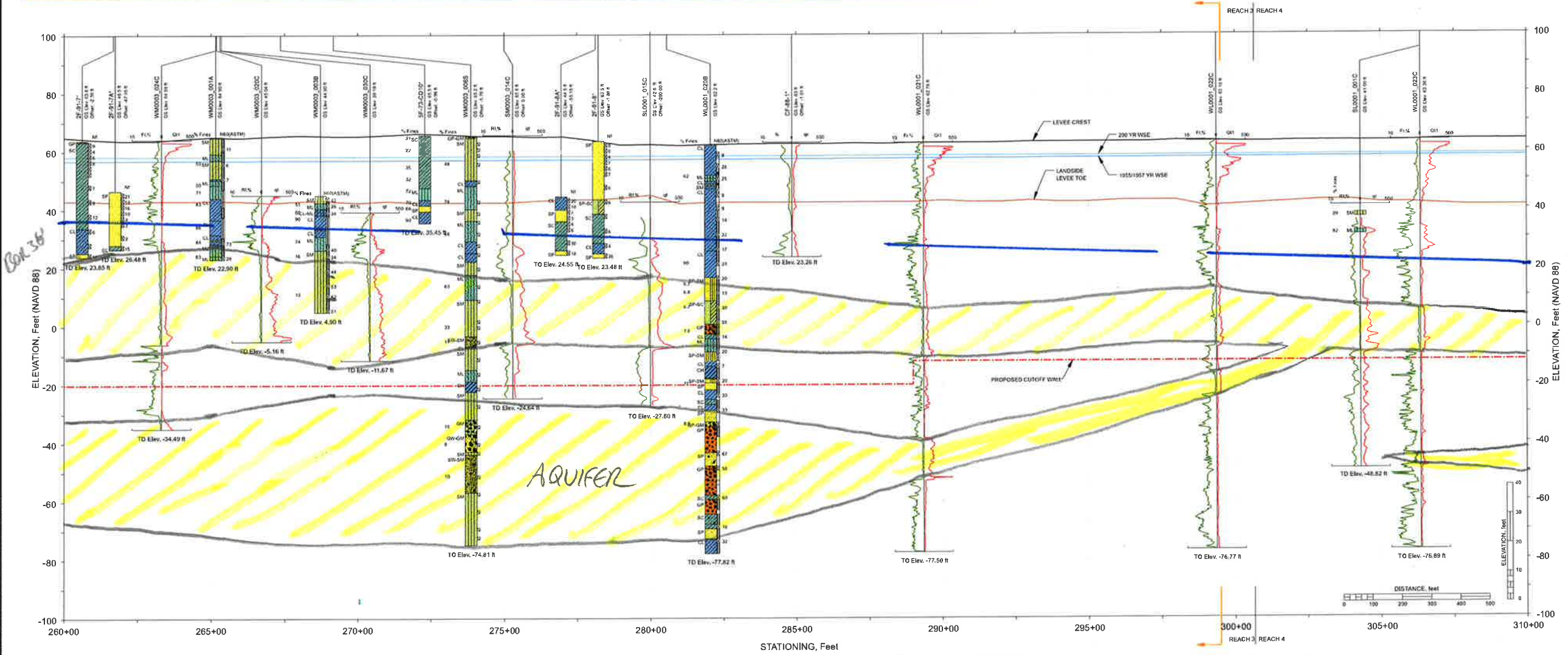

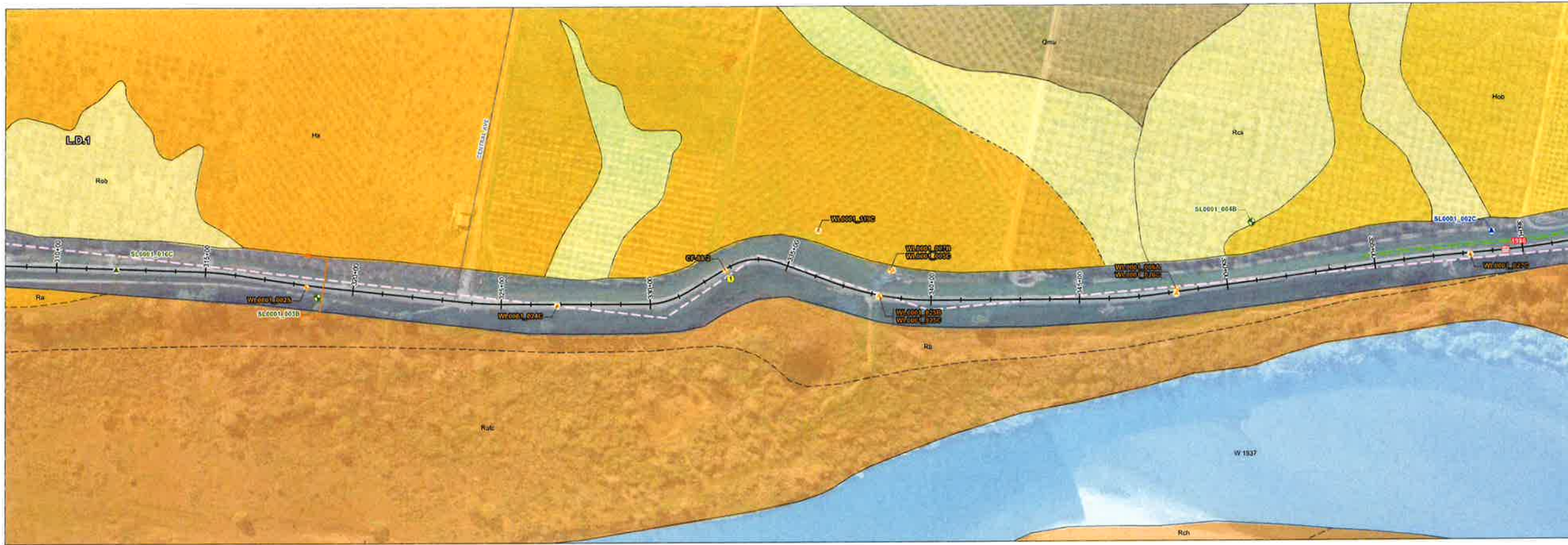

- NOTES:
- Elevations of levee crown and landside toe are approximate. These elevations were obtained from DWR CVFED or ULE LIDAR data and used for geotechnical analyses and report purpose only. For detail crown elevation and landside toe information, please refer to the FRWL Project civil drawings.
 - The water surface elevations are based on information provided by Peterson Brustad, Inc. in their July 26, 2012 report entitled "Design Water Surface Profiles for the Feather River West Levee Rehabilitation Project Addendum #1".
 - Locations of explorations are approximate. Stick logs represent general soil conditions encountered at the time of exploration. For more detailed information on the materials encountered, refer to boring end CPT logs in the Geotechnical Data Report for the FRWL Project. No warranty is provided regarding the continuity of soil conditions between individual explorations.
 - When reported, $N_{60}(ASTM)$, refers to $N_{60}(ASTM) = N_{60}$ Hammer Efficiency (%). See Geotechnical Data Report for the FRWL Project for hammer efficiency data for individual borings.
 - These drawings do not include all historical explorations on the profile view. Historical explorations from the DWR ULE project are shown; "other" historical explorations are identified by an asterisk (*) in the exploration ID. For these "other" historical borings, blow counts are field blow counts (NF) and USCS classifications are visual classifications.
 - USCS classification labels are not presented on the stick logs for soil lenses (thickness less than 1.5 feet).
 - This is a color figure. Black and white reproduction should not be relied upon as data will be lost.
 - To prevent scale distortion, this map should be printed on a "D" size sheet (22x34 inches).
 - Surficial geology was mapped at 1:20,000 scale. (Source: SGDR for DWR ULE Project, URS, 2010).
 - The information provided in these plans and stick-log plates has been compiled from a variety of sources. URS does not attest to the accuracy, completeness, or reliability of geotechnical exploration and other subsurface data by others that are included or referenced in these plates.
 - These plans and stick-log plates are for the use and benefit of HDR, SBFCA, and their consultants in connection with the execution of the FRWL Project. Use by any other party is at their own discretion and risk. These figures should not be used as the sole basis for design, construction, remedial action, or major capital spending decisions.
 - The canal/ditch elevations are approximate. These elevations were estimated from the topography.

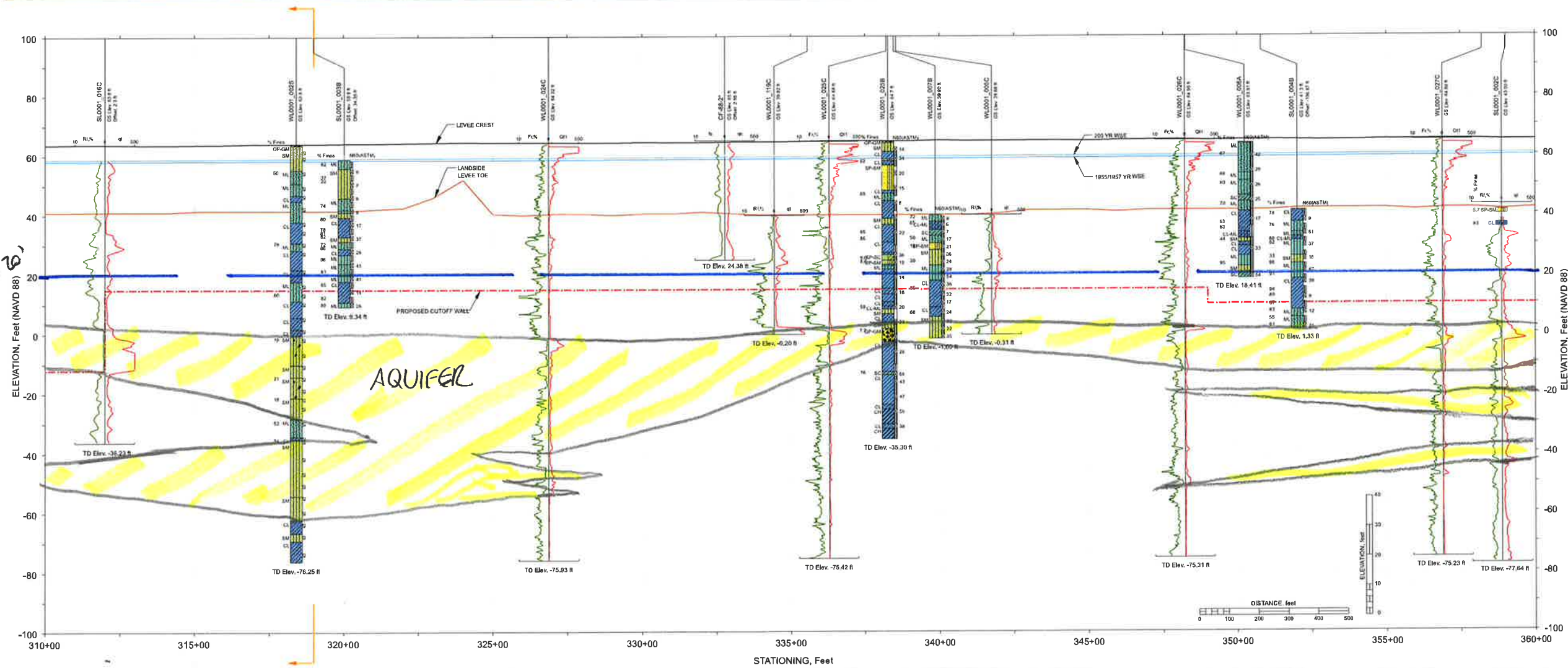

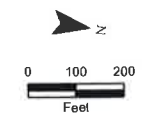
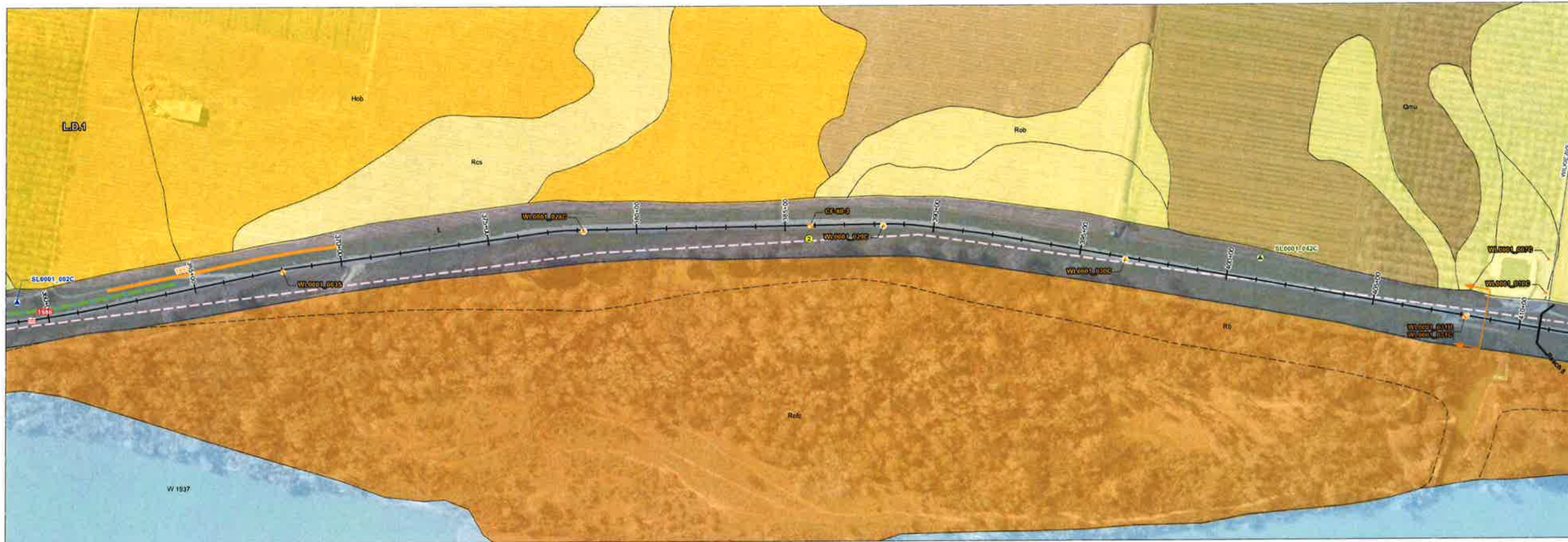

- NOTES:
1. Elevations of levee crown and landside toe are approximate. These elevations were obtained from DWR CVFED or ULE LIDAR data and used for geotechnical analyses and report purpose only. For detail crown elevation and landside toe information, please refer to the FRWL Project civil drawings.
 2. The water surface elevations are based on information provided by Peterson Bruslad, Inc. in their July 26, 2012 report entitled "Design Water Surface Profiles for the Feather River West Levee Rehabilitation Project Addendum #1".
 3. Locations of explorations are approximate. Stick logs represent general soil conditions encountered at the time of exploration. For more detailed information on the materials encountered, refer to boring and CPT logs in the Geotechnical Data Report for the FRWL Project. No warranty is provided regarding the continuity of soil conditions between individual explorations.
 4. When reported, N_{60} (ASTM) refers to N_{60} (ASTM) = N_{60} Hammer Efficiency (%). See Geotechnical Data Report for the FRWL Project for hammer efficiency data for individual borings.
 5. These drawings do not include all historical explorations on the profile view. Historical explorations from the DWR ULE project are shown; "other" historical explorations are identified by an asterisk (*) in the exploration ID. For these "other" historical borings, blow counts are field blow counts (N) and USCS classifications are visual classifications.
 6. USCS classification labels are not presented on the stick logs for soil lenses (thickness less than 1.5 feet).
 7. This is a color figure. Black and white reproduction should not be relied upon as data will be lost.
 8. To prevent scale distortion, this map should be printed on a "D" size sheet (22x34 inches).
 9. Surficial geology was mapped at 1:20,000 scale. (Source: SGDR for DWR ULE Project, URS, 2010).
 10. The information provided in these plans and stick-log plates has been compiled from a variety of sources. URS does not attest to the accuracy, completeness, or reliability of geotechnical exploration and other subsurface data by others that are included or referenced in these plates.
 11. These plans and stick-log plates are for the use and benefit of HDR, SBFCA, and their consultants in connection with the execution of the FRWL Project. Use by any other party is at their own discretion and risk. These figures should not be used as the sole basis for design, construction, remedial action, or major capital spending decisions.
 12. The canal/ditch elevations are approximate. These elevations were estimated from the topography.

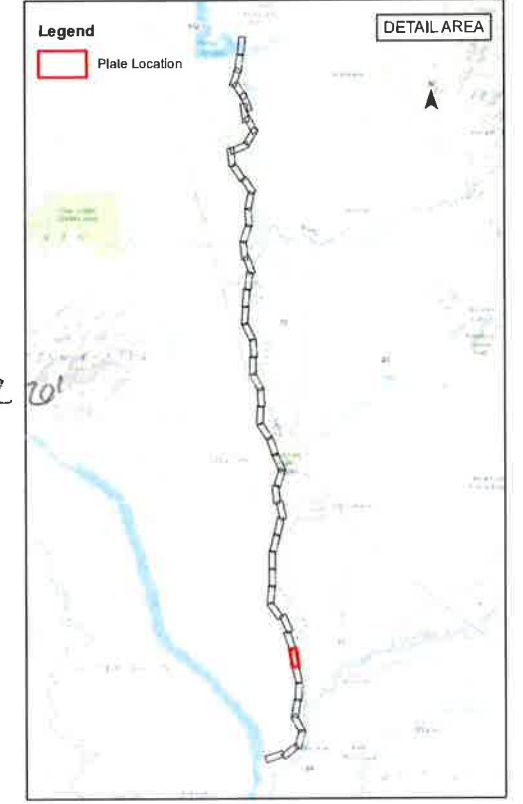
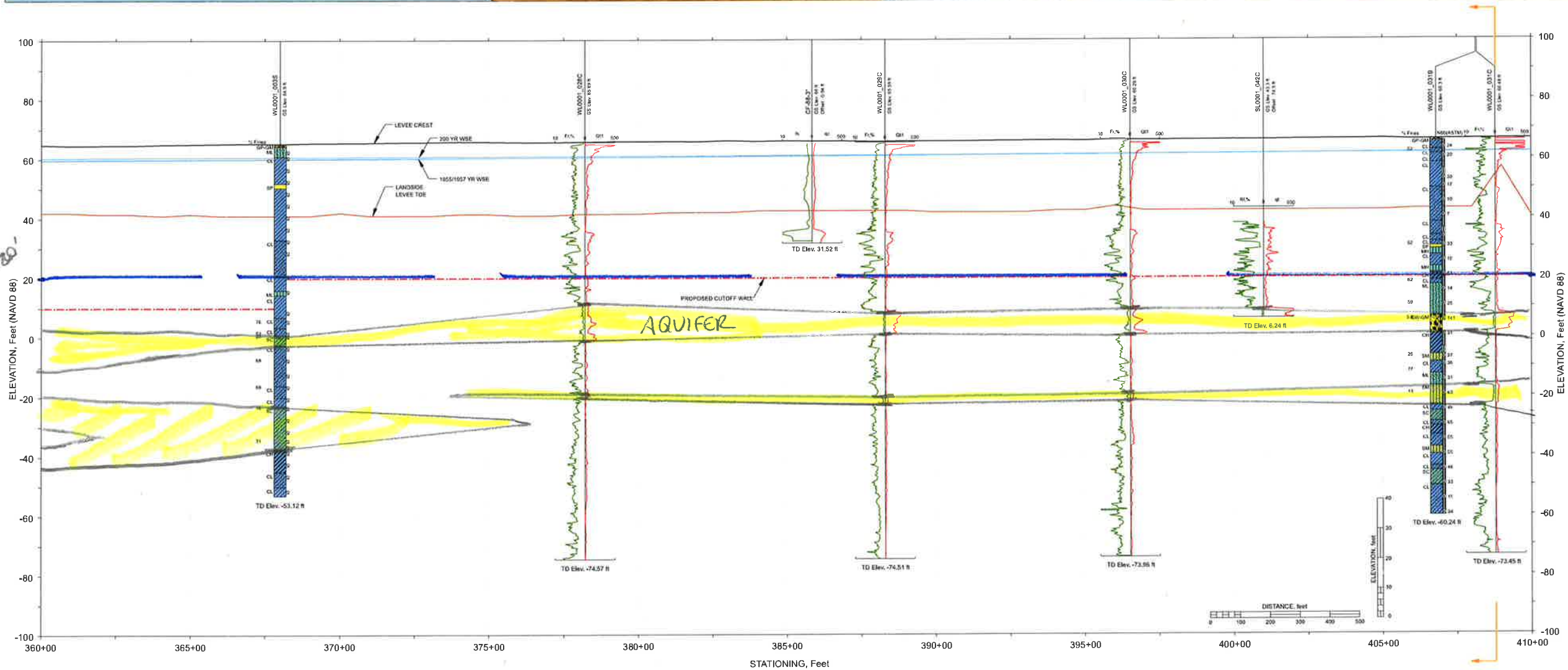

FRWL Project Plan Views and Stick Log Figures
FRWL Project: Station 360+00 to Station 410+00

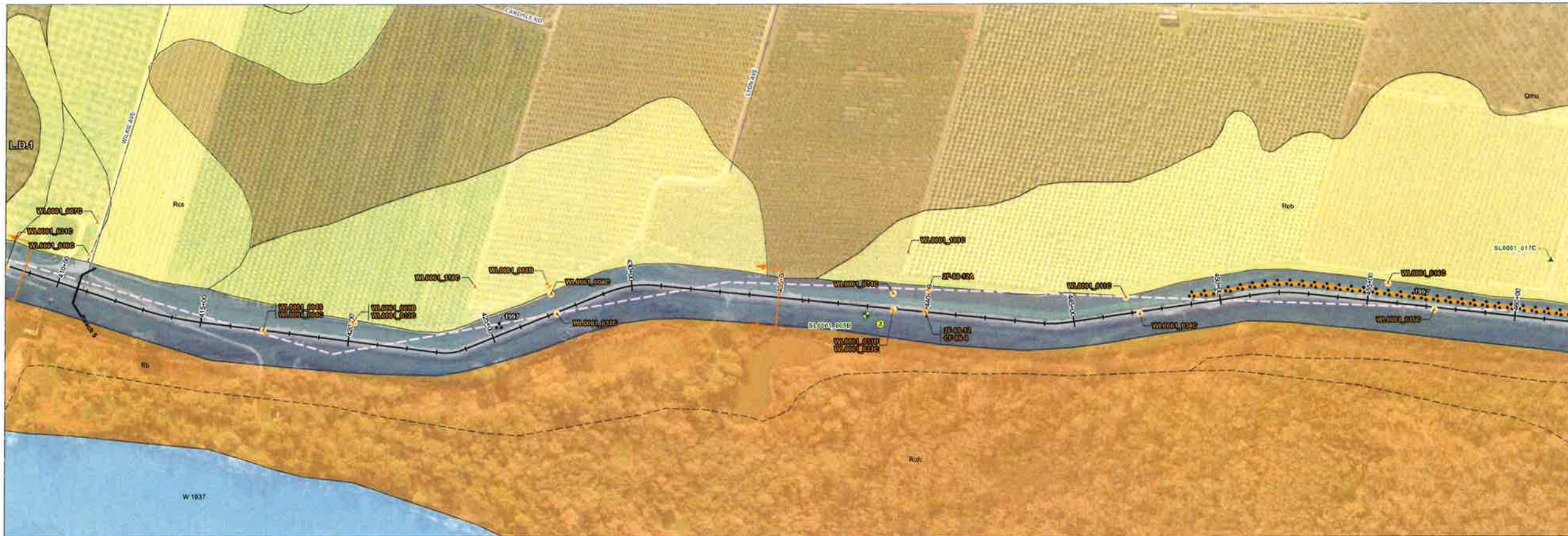

- NOTES:
1. Elevations of levee crown and landside toe are approximate. These elevations were obtained from DWR CVFED or ULE LIDAR data and used for geotechnical analyses and report purpose only. For detail crown elevation and landside toe information, please refer to the FRWL Project civil drawings.
 2. The water surface elevations are based on information provided by Peterson Brustad, Inc. in their July 26, 2012 report entitled "Design Water Surface Profiles for the Feather River West Levee Rehabilitation Project Addendum #1".
 3. Locations of explorations are approximate. Stick logs represent general soil conditions encountered at the time of exploration. For more detailed information on the materials encountered, refer to boring and CPT logs in the Geotechnical Data Report for the FRWL Project. No warranty is provided regarding the continuity of soil conditions between individual explorations.
 4. When reported, $N_{60}(ASTM)$, refers to $N_{60}(ASTM) = N_{60} \times$ Hammer Efficiency (%). See Geotechnical Data Report for the FRWL Project for hammer efficiency data for individual borings.
 5. These drawings do not include all historical explorations on the profile view. Historical explorations from the DWR ULE project are shown: "other" historical explorations are identified by an asterisk (*) in the exploration ID. For these "other" historical borings, blow counts are field blow counts (N) and USCS classifications are visual classifications.
 6. USCS classification labels are not presented on the stick logs for soil lenses (thickness less than 1.5 feet).
 7. This is a color figure. Black and white reproduction should not be relied upon as data will be lost.
 8. To prevent scale distortion, this map should be printed on a "D" size sheet (22x34 inches).
 9. Surficial geology was mapped at 1:20,000 scale. (Source: SGDR for DWR ULE Project, URS, 2010).
 10. The information provided in these plans and stick-log plates has been compiled from a variety of sources. URS does not attest to the accuracy, completeness, or reliability of geotechnical exploration and other subsurface data by others that are included or referenced in these plates.
 11. These plans and stick-log plates are for the use and benefit of HDR, SBFCA, and their consultants in connection with the execution of the FRWL Project. Use by any other party is at their own discretion and risk. These figures should not be used as the sole basis for design, construction, remedial action, or major capital spending decisions.
 12. The canal/ditch elevations are approximate. These elevations were estimated from the topography.

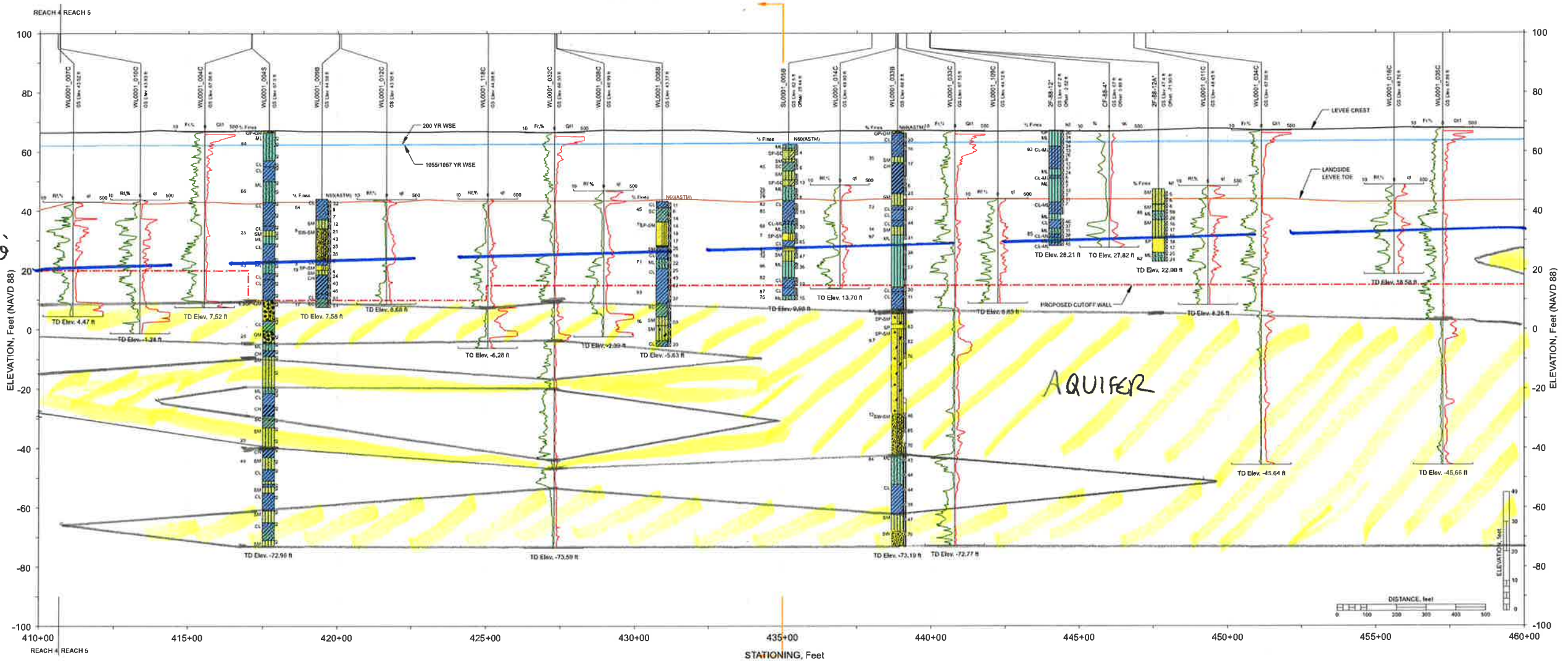

PART OF NEW WALL, ALL OF EXISTING WALL CUTS OFF UPPER AQUIFER

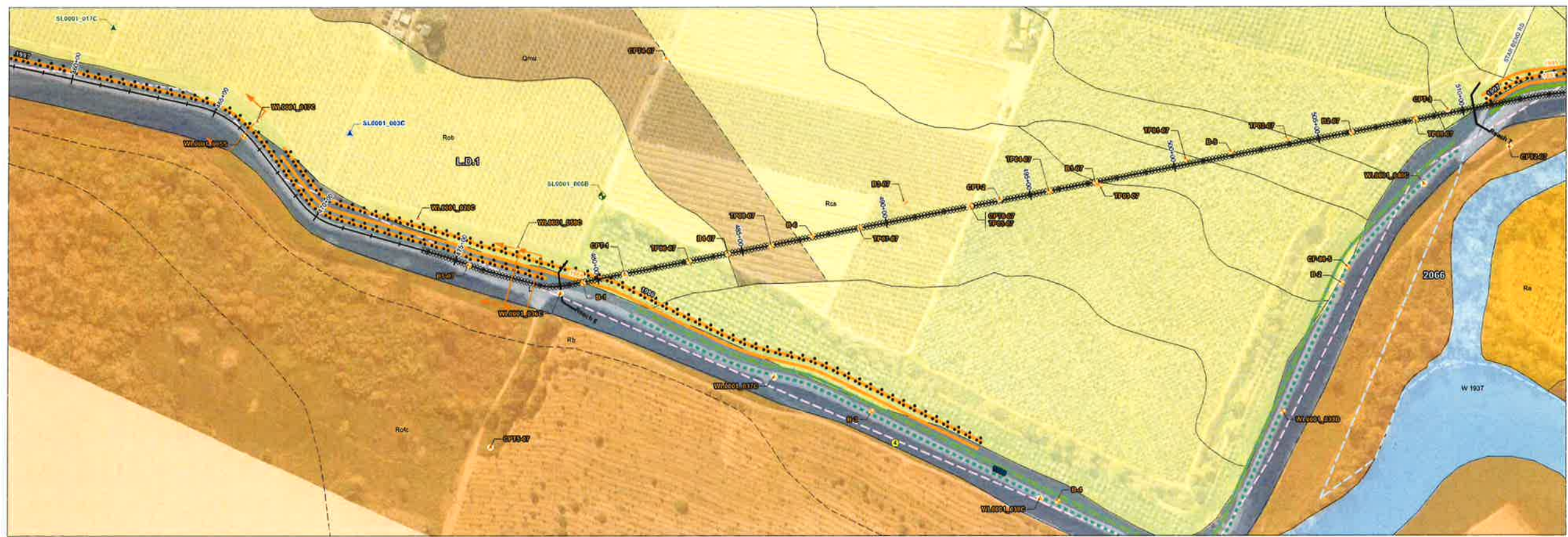

- NOTES:
1. Elevations of levee crown and landside toe are approximate. These elevations were obtained from DWR CVFED or ULE LIDAR data and used for geotechnical analyses and report purpose only. For detail crown elevation and landside toe information, please refer to the FRWL Project civil drawings.
 2. The water surface elevations are based on information provided by Peterson Brustad, Inc. in their July 26, 2012 report entitled "Design Water Surface Profiles for the Feather River West Levee Rehabilitation Project Addendum #1".
 3. Locations of explorations are approximate. Stick logs represent general soil conditions encountered at the time of exploration. For more detailed information on the materials encountered, refer to boring and CPT logs in the Geotechnical Data Report for the FRWL Project. No warranty is provided regarding the continuity of soil conditions between individual explorations.
 4. When reported, $N_{60}(ASTM)$ refers to $N_{60}(ASTM) = N_{max} * \text{Hemmer Efficiency } (\%)$. See Geotechnical Data Report for the FRWL Project for hammer efficiency data for individual borings.
 5. These drawings do not include all historical explorations on the profile view. Historical explorations from the DWR ULE project are shown; "other" historical explorations are identified by an asterisk (*) in the exploration ID. For these "other" historical borings, blow counts are field blow counts (Nf) and USCS classifications are visual classifications.
 6. USCS classification labels are not presented on the stick logs for soil lenses (thickness less than 1.5 feet).
 7. This is a color figure. Black and white reproduction should not be relied upon as data will be lost.
 8. To prevent scale distortion, this map should be printed on a "D" size sheet (22x34 inches).
 9. Surficial geology was mapped at 1:20,000 scale. (Source: SGRD for DWR ULE Project, URS, 2010).
 10. The information provided in these plans and stick-log plates has been compiled from a variety of sources. URS does not attest to the accuracy, completeness, or reliability of geotechnical exploration and other subsurface data by others that are included or referenced in these plates.
 11. These plans and stick-log plates are for the use and benefit of HDR, SBFCA, and their consultants in connection with the execution of the FRWL Project. Use by any other party is at their own discretion and risk. These figures should not be used as the sole basis for design, construction, remedial action, or major capital spending decisions.
 12. The canalside elevations are approximate. These elevations were estimated from the topography.

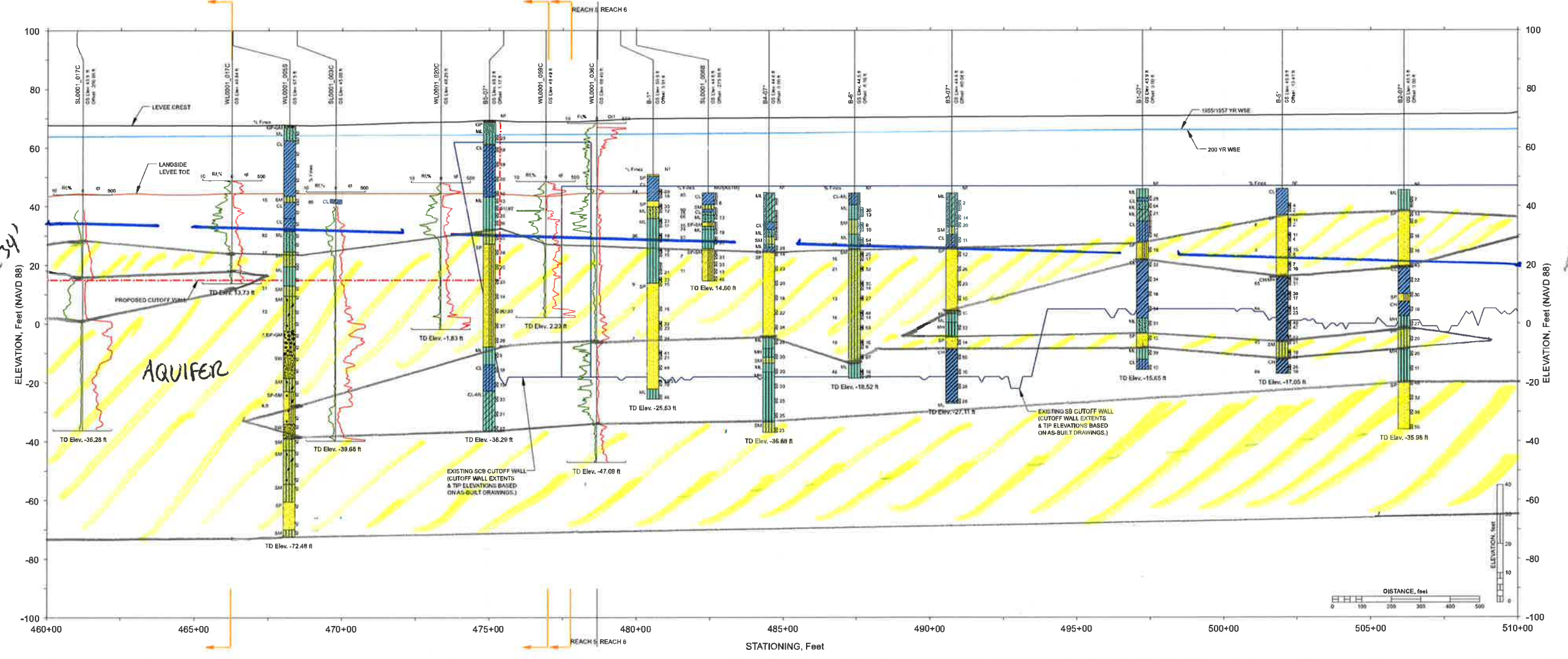

NEW WALL CUTS OFF UPPER AQUIFER

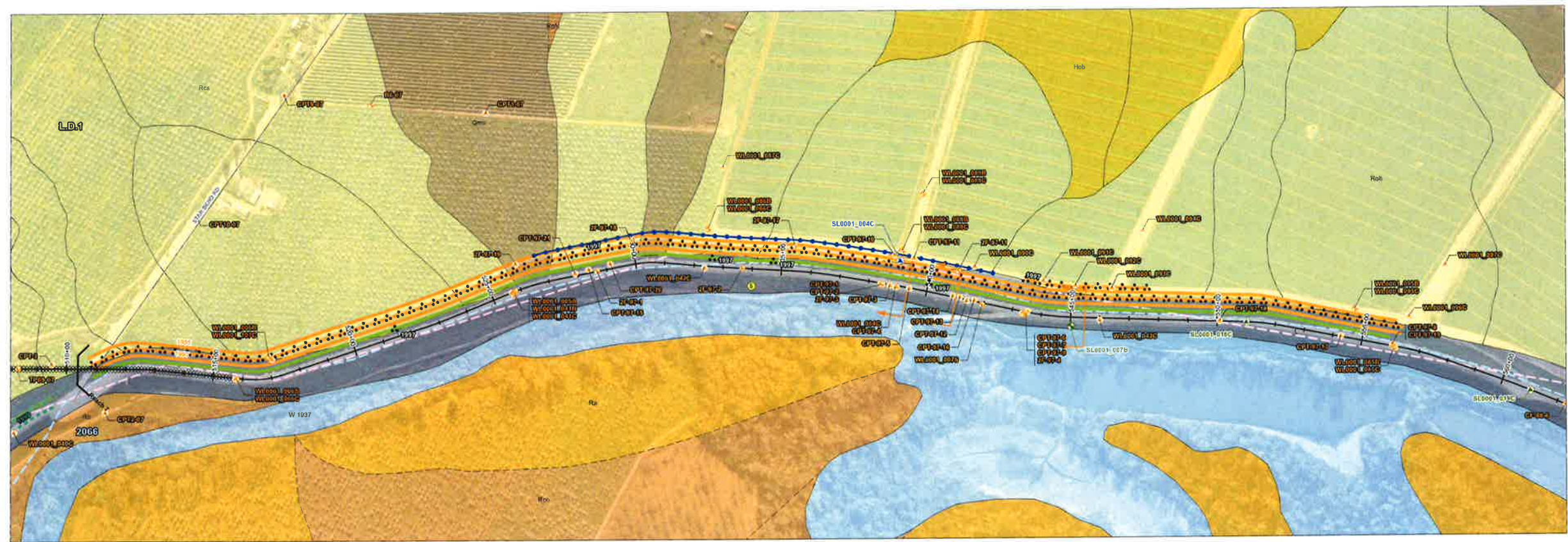

- 0 100 200 Feet
- NOTES:
- Elevations of levee crown and landside toe are approximate. These elevations were obtained from DWR CVFED or ULE LIDAR data and used for geotechnical analyses and report purpose only. For detail crown elevation and landside toe information, please refer to the FRWL Project civil drawings.
 - The water surface elevations are based on information provided by Peterson Bruslad, Inc. in their July 26, 2012 report entitled "Design Water Surface Profiles for the Feather River West Levee Rehabilitation Project Addendum #1".
 - Locations of explorations are approximate. Stick logs represent general soil conditions encountered at the time of exploration. For more detailed information on the materials encountered, refer to boring and CPT logs in the Geotechnical Data Report for the FRWL Project. No warranty is provided regarding the continuity of soil conditions between individual explorations.
 - When reported, N_{60} (ASTM) refers to N_{60} (ASTM) = N_{60} * Hammer Efficiency (%). See Geotechnical Data Report for the FRWL Project for hammer efficiency data for individual borings.
 - These drawings do not include all historical explorations on the profile view. Historical explorations from the DWR ULE project are shown; "other" historical explorations are identified by an asterisk (*) in the exploration ID. For these "other" historical borings, blow counts are field blow counts (NF) and USCS classifications are visual classifications.
 - USCS classification labels are not presented on the stick logs for soil lenses (thickness less than 1.5 feet).
 - This is a color figure. Black and white reproduction should not be relied upon as data will be lost.
 - To prevent scale distortion, this map should be printed on a "D" size sheet (22x34 inches).
 - Surficial geology was mapped at 1:20,000 scale. (Source: SGRD for DWR ULE Project, URS, 2010).
 - The information provided in these plans and stick-log plates has been compiled from a variety of sources. URS does not attest to the accuracy, completeness, or reliability of geotechnical exploration and other subsurface data by others that are included or referenced in these plans.
 - These plans and stick-log plates are for the use and benefit of HDR, SBFCA, and their consultants in connection with the execution of the FRWL Project. Use by any other party is at their own discretion and risk. These figures should not be used as the sole basis for design, construction, remedial action, or major capital spending decisions.
 - The canal ditch elevations are approximate. These elevations were estimated from the topography.

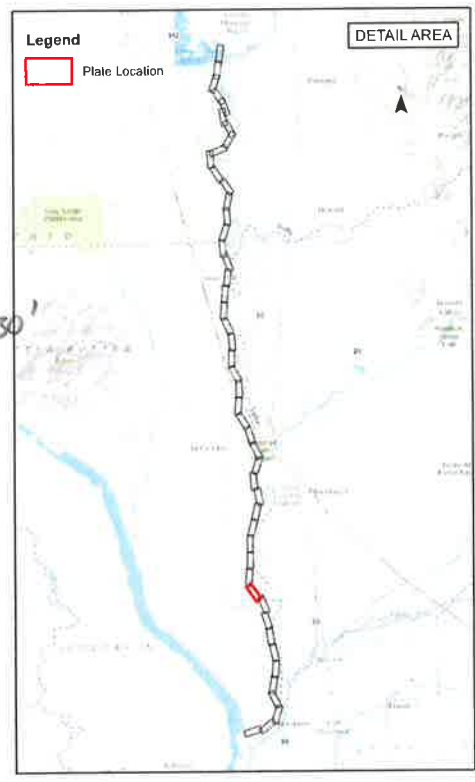
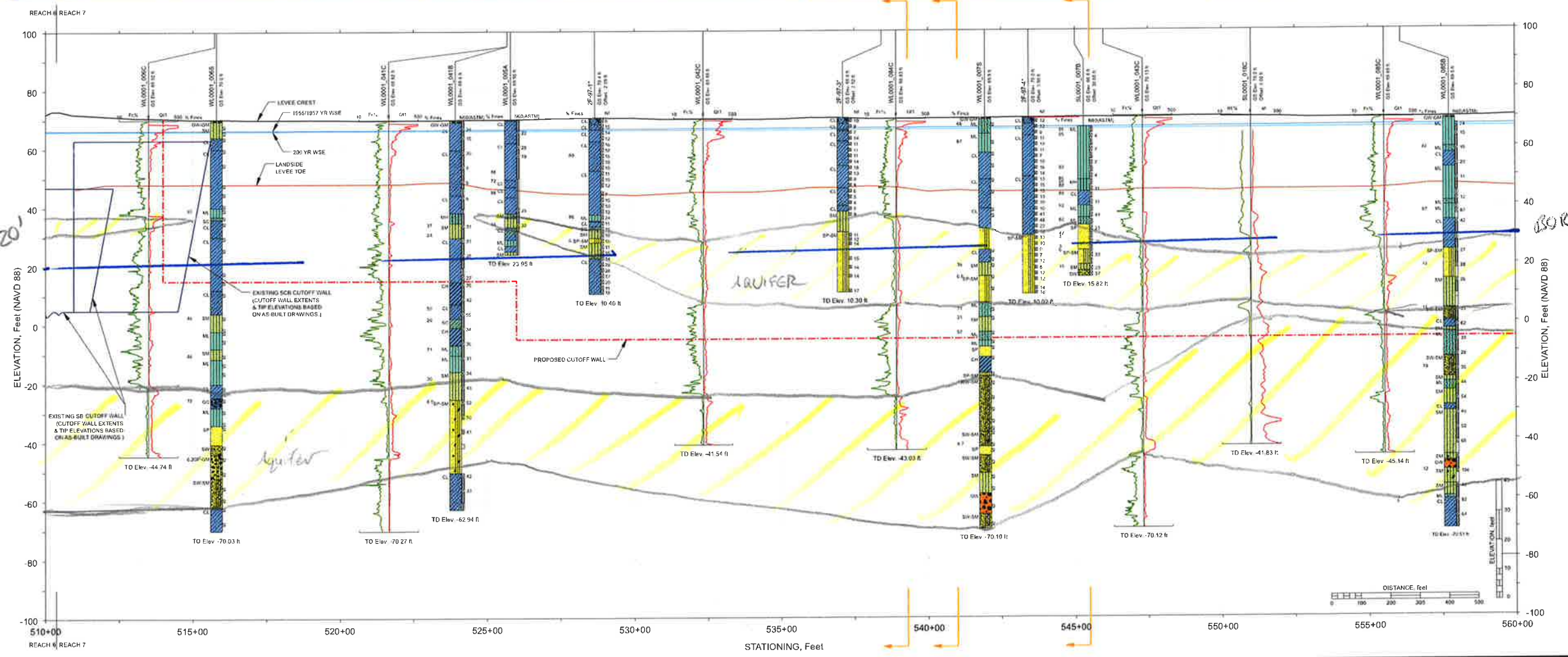

FRWL Project Plan Views and Stick Log Figures
FRWL Project: Station 510+00 to Station 560+00

NEW WALL CUTS OFF UPPER AQUIFER TO STA. 595+00

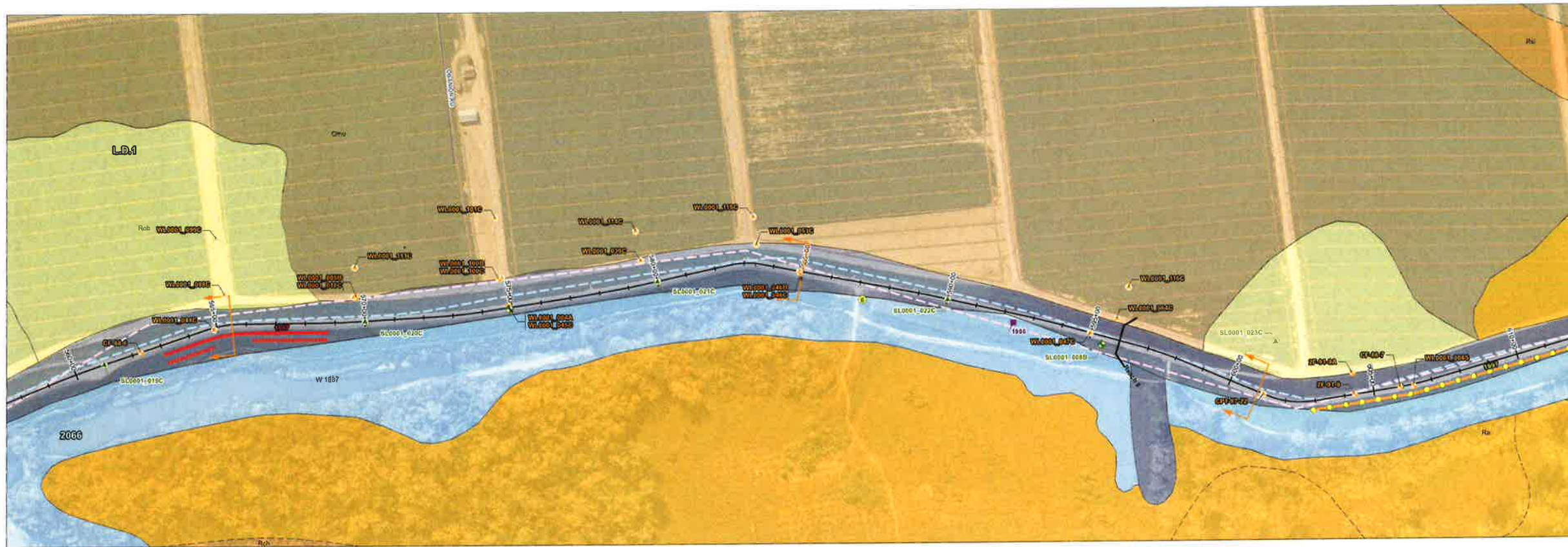

- 0 100 200
Feet
- NOTES:
- Elevations of levee crown and landside toe are approximate. These elevations were obtained from DWR CVFED or ULE LIDAR data and used for geotechnical analyses and report purpose only. For detail crown elevation and landside toe information, please refer to the FRWL Project civil drawings.
 - The water surface elevations are based on information provided by Peterson Brustad, Inc. in their July 26, 2012 report entitled "Design Water Surface Profiles for the Feather River West Levee Rehabilitation Project Addendum #1".
 - Locations of explorations are approximate. Stick logs represent general soil conditions encountered at the time of exploration. For more detailed information on the materials encountered, refer to boring and CPT logs in the Geotechnical Data Report for the FRWL Project. No warranty is provided regarding the continuity of soil conditions between individual explorations.
 - When reported, $N_{60}(ASTM)$ refers to $N_{60}(ASTM) = N_{60} * \text{Hammer Efficiency} (\%)$. See Geotechnical Data Report for the FRWL Project for hammer efficiency data for individual borings.
 - These drawings do not include all historical explorations on the profile view. Historical explorations from the DWR ULE project are shown; "other" historical explorations are identified by an asterisk (*) in the exploration ID. For these "other" historical borings, blow counts are field blow counts (NI) and USCS classifications are visual classifications.
 - USCS classification labels are not presented on the stick logs for soil lenses (thickness less than 1.5 feet).
 - This is a color figure. Black and white reproduction should not be relied upon as data will be lost.
 - To prevent scale distortion, this map should be printed on a "D" size sheet (22x34 inches).
 - Surficial geology was mapped at 1:20,000 scale. (Source: SGDR for DWR ULE Project, URS, 2010).
 - The information provided in these plans and stick-log plates has been compiled from a variety of sources. URS does not attest to the accuracy, completeness, or reliability of geotechnical exploration and other subsurface data by others that are included or referenced in these plates.
 - These plans and stick-log plates are for the use and benefit of HDR, SBFCA, and their consultants in connection with the execution of the FRWL Project. Use by any other party is at their own discretion and risk. These figures should not be used as the sole basis for design, construction, remedial action, or major capital spending decisions.
 - The sandfill elevations are approximate. These elevations were estimated from the topography.

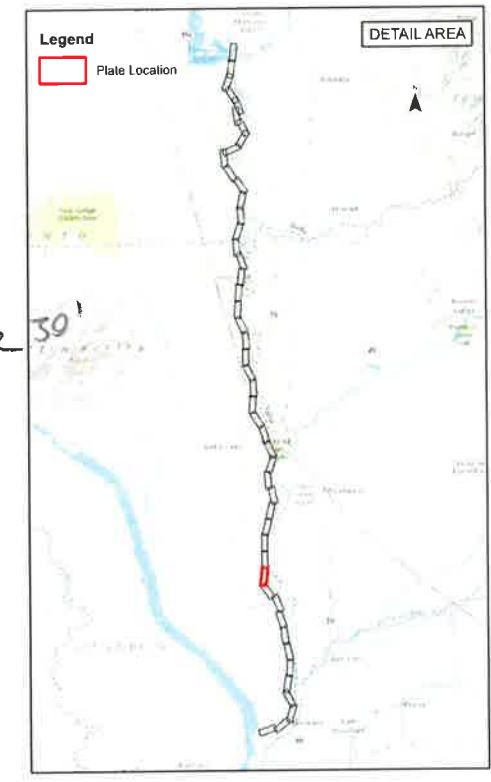
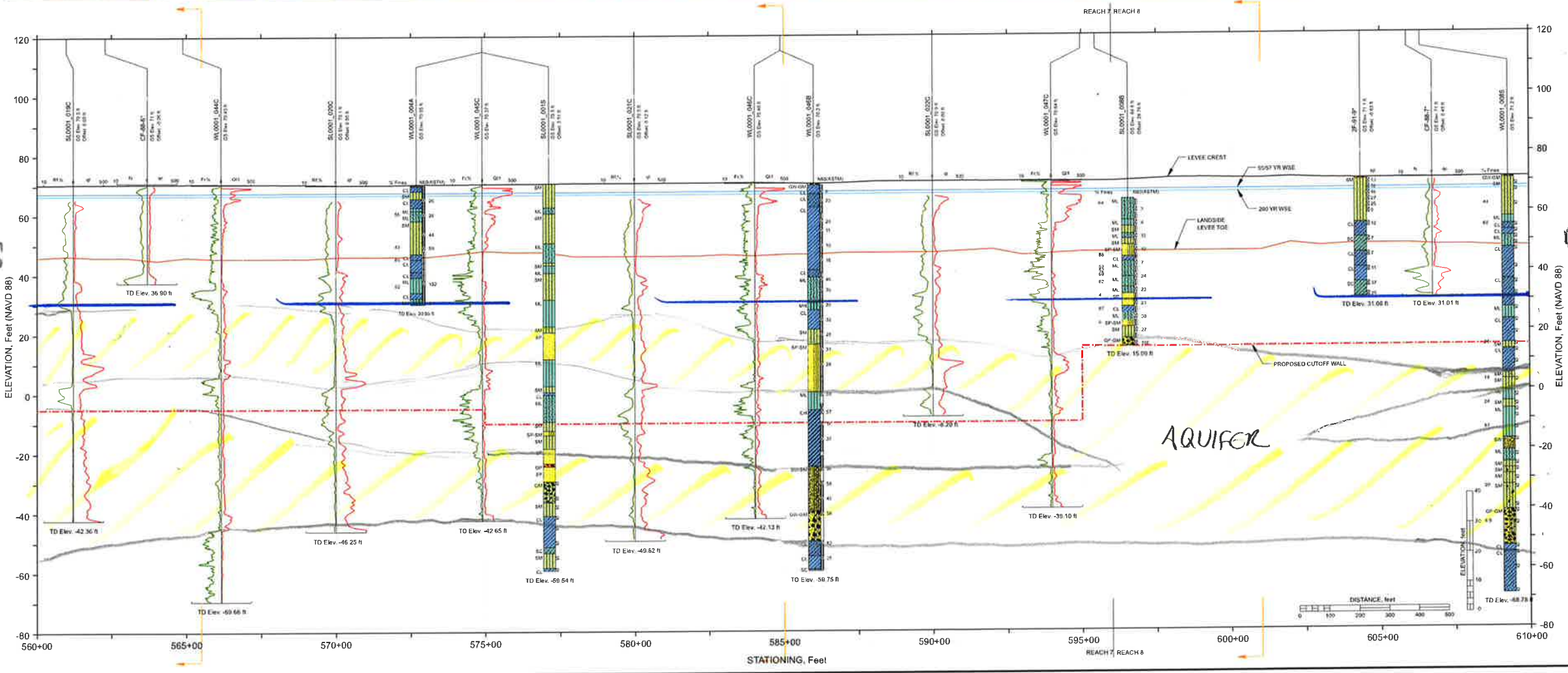

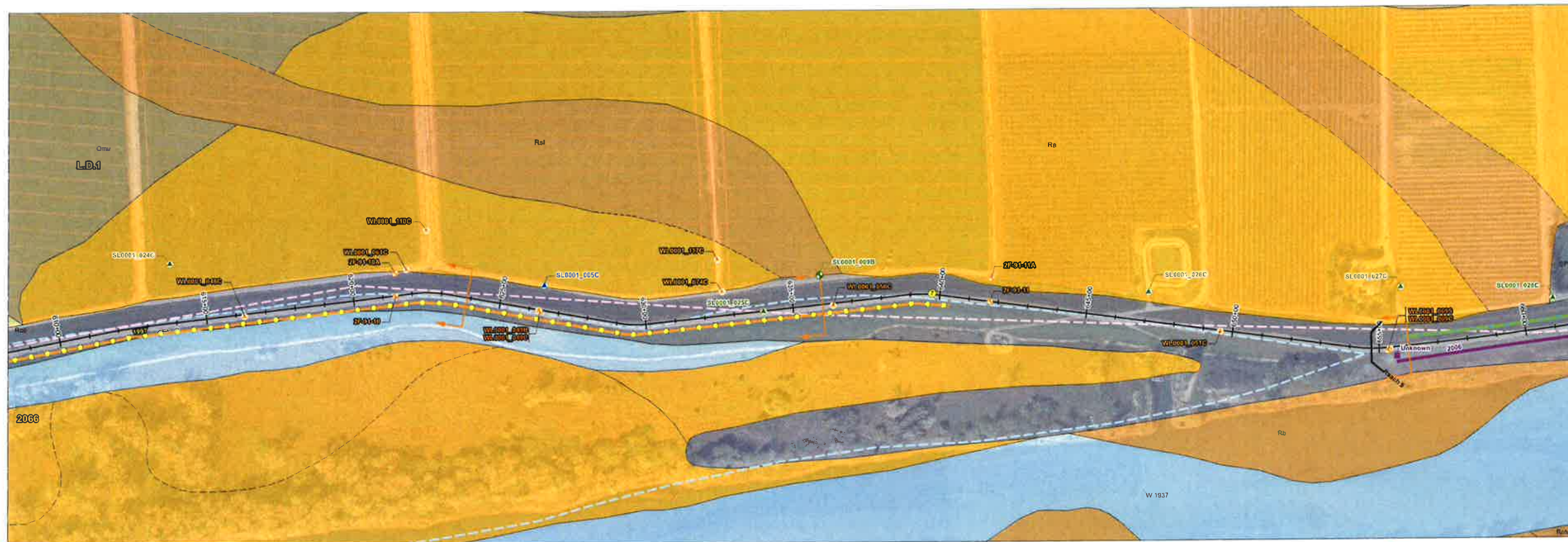

- 7
- 0 100 200
Feet
- NOTES:
- Elevations of levee crown and landside toe are approximate. These elevations were obtained from DWR CVFED or ULE LIDAR data and used for geotechnical analyses and report purpose only. For detail crown elevation and landside toe information, please refer to the FRWL Project civil drawings.
 - The water surface elevations are based on information provided by Peterson Brustad, Inc. in their July 26, 2012 report entitled "Design Water Surface Profiles for the Feather River West Levee Rehabilitation Project Addendum #1".
 - Locations of explorations are approximate. Stick logs represent general soil conditions encountered at the time of exploration. For more detailed information on the materials encountered, refer to boring and CPT logs in the Geotechnical Data Report for the FRWL Project. No warranty is provided regarding the continuity of soil conditions between individual explorations.
 - When reported, $N_{60}(ASTM)$ refers to $N_{60}(ASTM) = N_{60} \cdot \text{Hammer Efficiency (\%)}$. See Geotechnical Data Report for the FRWL Project for hammer efficiency data for individual borings.
 - These drawings do not include all historical explorations on the profile view. Historical explorations from the DWR ULE project are shown; "other" historical explorations are identified by an asterisk (*) in the exploration ID. For these "other" historical borings, blow counts are field blow counts (N) and USCS classifications are visual classifications.
 - USCS classification labels are not presented on the stick logs for soil lenses (thickness less than 1.5 feet).
 - This is a color figure. Black and white reproduction should not be relied upon as data will be lost.
 - To prevent scale distortion, this map should be printed on a "D" size sheet (22x34 inches).
 - Surficial geology was mapped at 1:20,000 scale. (Source: SGDR for DWR ULE Project, URS.2010).
 - The information provided in these plans and stick-log plates has been compiled from a variety of sources. URS does not attest to the accuracy, completeness, or reliability of geotechnical exploration and other subsurface data by others that are included or referenced in these plates.
 - These plans and stick-log plates are for the use and benefit of HDR, SBFA, and their consultants in connection with the execution of the FRWL Project. Use by any other party is at their own discretion and risk. These figures should not be used as the sole basis for design, construction, remedial action, or major capital spending decisions.
 - The cantilever elevations are approximate. These elevations were estimated from the topography.

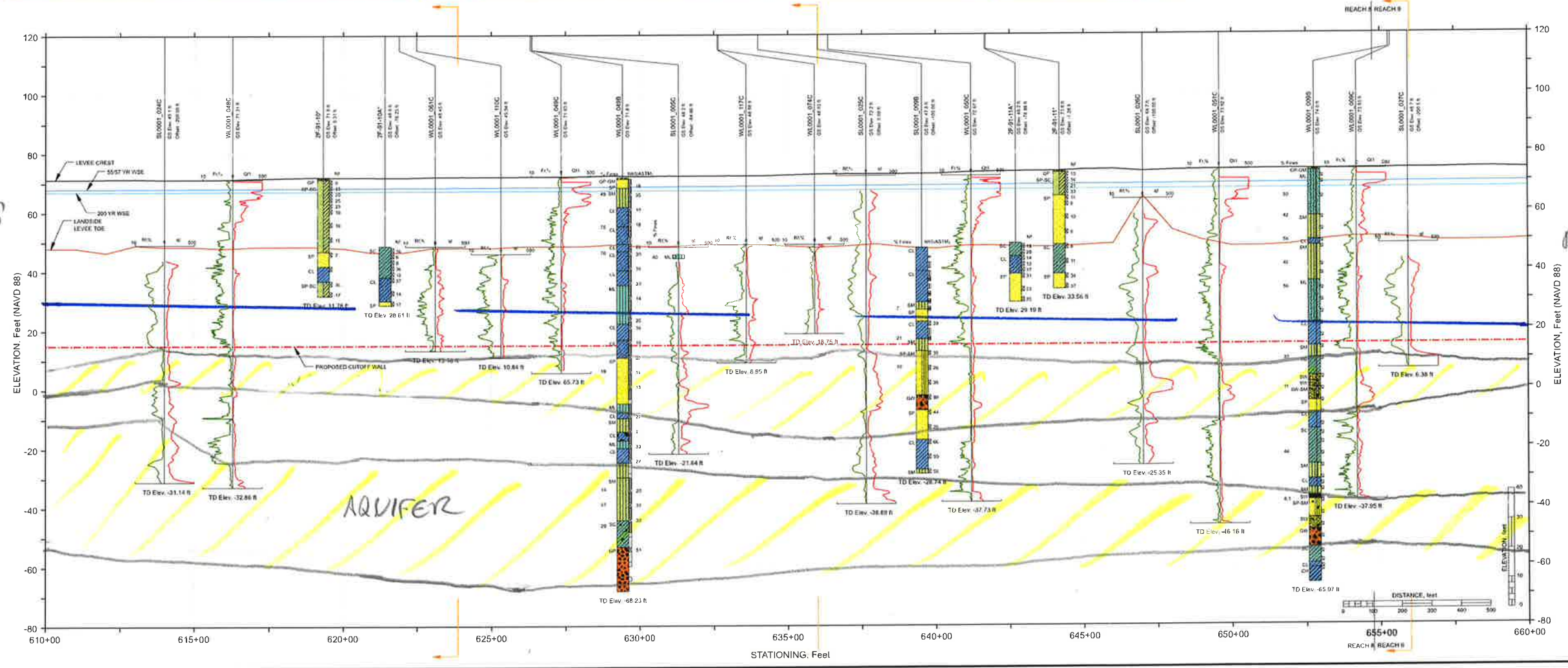

NEW WALL CURS OFF UPPER AQUIFER FROM STA. 697+00 TO 750+00

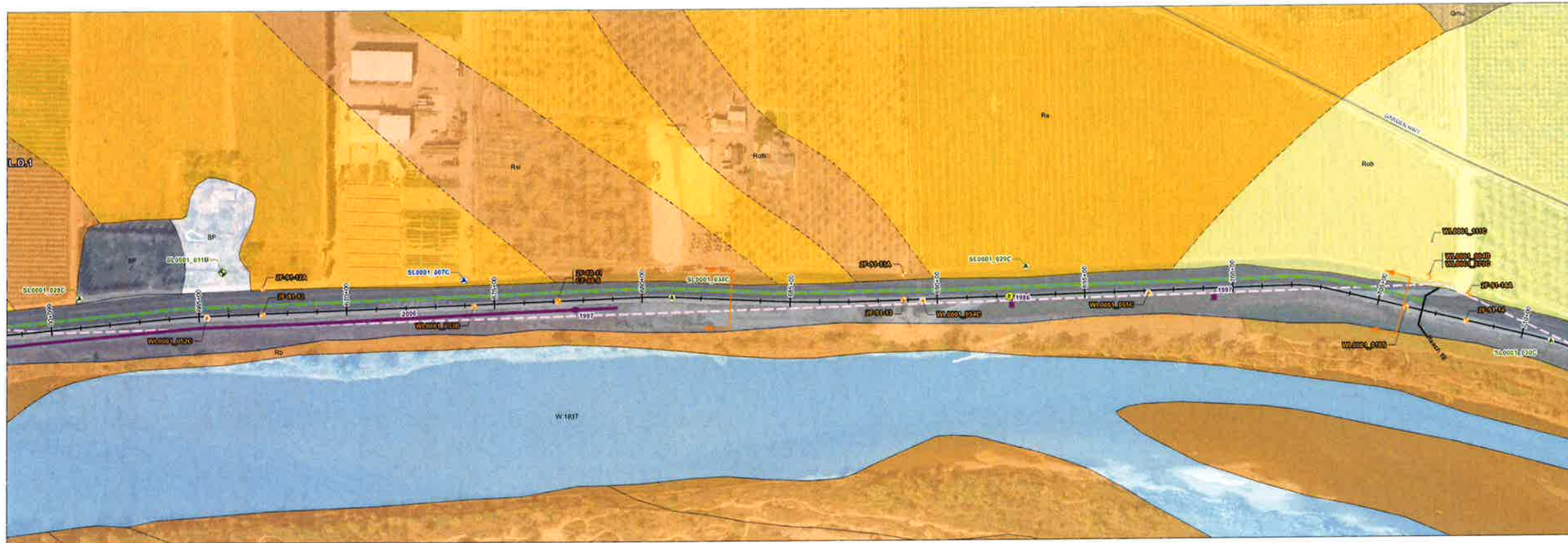

- NOTES:
- Elevations of levee crown and landside toe are approximate. These elevations were obtained from DWR CVFED or ULE LIDAR data and used for geotechnical analyses and report purpose only. For detail crown elevation and landside toe information, please refer to the FRWL Project civil drawings.
 - The water surface elevations are based on information provided by Peterson Brustad, Inc. in their July 26, 2012 report entitled "Design Water Surface Profiles for the Feather River West Levee Rehabilitation Project Addendum #1".
 - Locations of explorations are approximate. Stick logs represent general soil conditions encountered at the time of exploration. For more detailed information on the materials encountered, refer to boring and CPT logs in the Geotechnical Data Report for the FRWL Project. No warranty is provided regarding the continuity of soil conditions between individual explorations.
 - When reported, $N_{60}(ASTM)$ refers to $N_{60}(ASTM) = N_{60} * \text{Hammer Efficiency } (\%)$. See Geotechnical Data Report for the FRWL Project for hammer efficiency data for individual borings.
 - These drawings do not include all historical explorations on the profile view. Historical explorations from the DWR ULE project are shown; "other" historical explorations are identified by an asterisk (*) in the exploration ID. For these "other" historical borings, blow counts are field blow counts (NF) and USCS classifications are visual classifications.
 - USCS classification labels are not presented on the stick logs for soil lenses (thickness less than 1.5 feet).
 - This is a color figure. Black and white reproduction should not be relied upon as data will be lost.
 - To prevent scale distortion, this map should be printed on a "D" size sheet (22x34 inches).
 - Surficial geology was mapped at 1:20,000 scale. (Source: SGRD for DWR ULE Project, URS, 2010).
 - The information provided in these plans and stick-log plates has been compiled from a variety of sources. URS does not attest to the accuracy, completeness, or reliability of geotechnical exploration and other subsurface data by others that are included or referenced in these plates.
 - These plans and stick-log plates are for the use and benefit of HDR, SBFCA, and their consultants in connection with the execution of the FRWL Project. Use by any other party is at their own discretion and risk. These figures should not be used as the sole basis for design, construction, remedial action, or major capital spending decisions.
 - The canal/ditch elevations are approximate. These elevations were estimated from the topography.

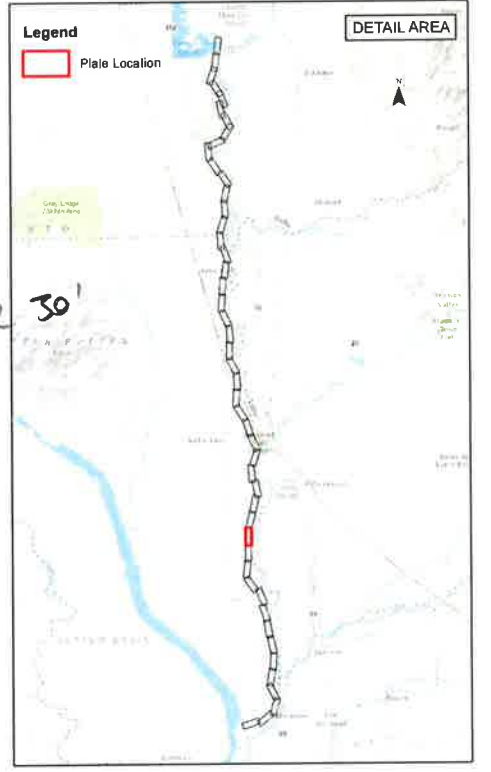
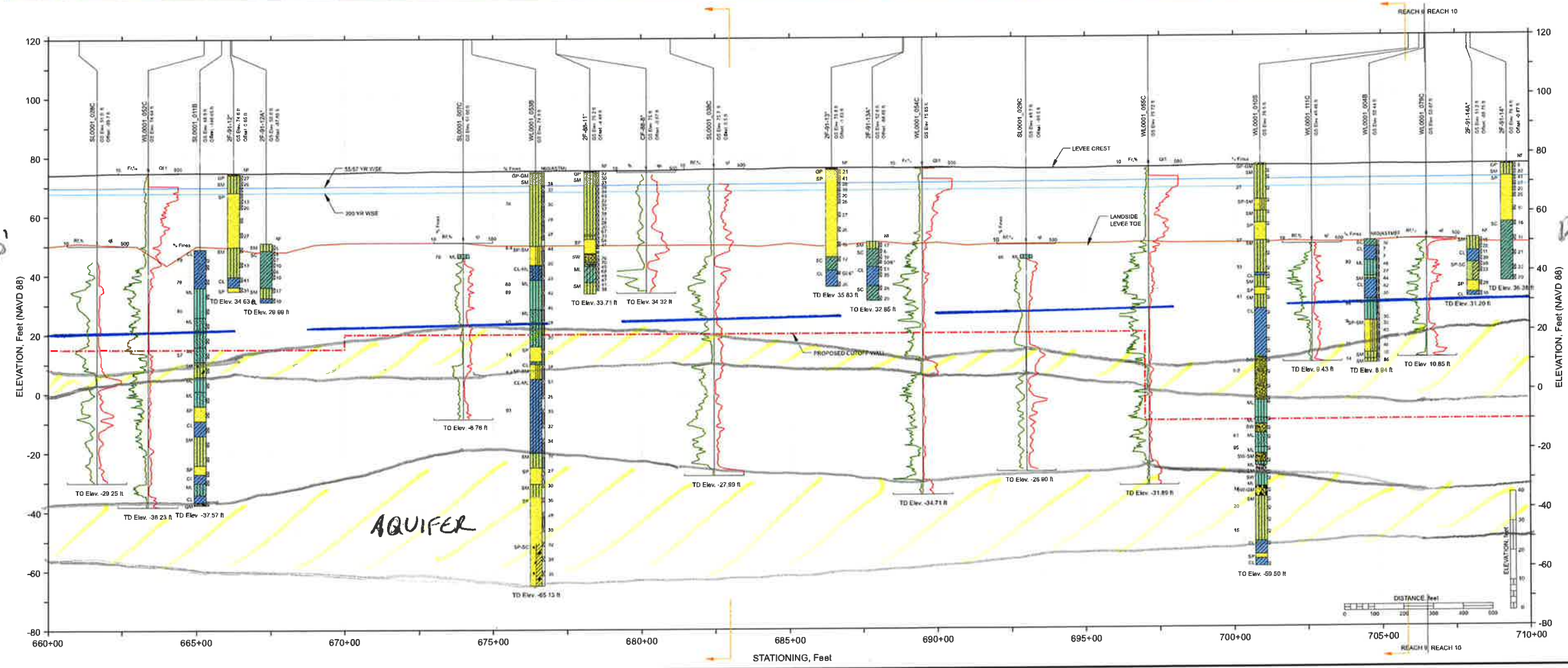

NEW WALL CUTS OFF UPPER AQUIFER FROM ~ STA. 717+00 TO 759+00

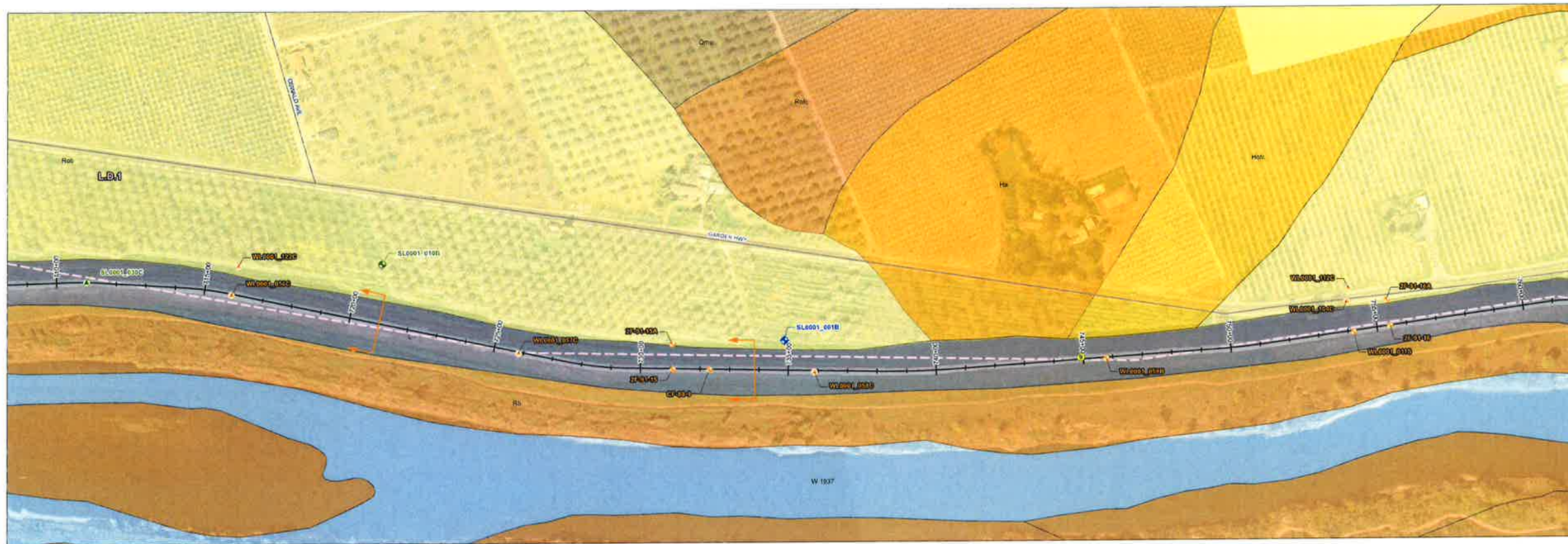

- 0 100 200 Feet
- NOTES:
- Elevations of levee crown and landside toe are approximate. These elevations were obtained from DWR CVFED or ULE LIDAR data and used for geotechnical analyses and report purpose only. For detail crown elevation and landside toe information, please refer to the FRWL Project civil drawings.
 - The water surface elevations are based on information provided by Peterson Brustad, Inc. in their July 26, 2012 report entitled "Design Water Surface Profiles for the Feather River West Levee Rehabilitation Project Addendum #1".
 - Locations of explorations are approximate. Stick logs represent general soil conditions encountered at the time of exploration. For more detailed information on the materials encountered, refer to boring and CPT logs in the Geotechnical Data Report for the FRWL Project. No warranty is provided regarding the continuity of soil conditions between individual explorations.
 - When reported, N_{60} (ASTM) refers to N_{60} (ASTM) = N_{60} * Hammer Efficiency (%). See Geotechnical Data Report for the FRWL Project for hammer efficiency data for individual borings.
 - These drawings do not include all historical explorations on the profile view. Historical explorations from the DWR ULE project are shown; "other" historical explorations are identified by an asterisk (*) in the exploration ID. For these "other" historical borings, blow counts are field blow counts (N) and USCS classifications are visual classifications.
 - USCS classification labels are not presented on the stick logs for soil lenses (thickness less than 1.5 feet).
 - This is a color figure. Black and white reproduction should not be relied upon as data will be lost.
 - To prevent scale distortion, this map should be printed on a D-size sheet (22x34 inches).
 - Surficial geology was mapped at 1:20,000 scale. (Source: SGRD for DWR ULE Project, URS, 2010).
 - The information provided in these plans and stick-log plates has been compiled from a variety of sources. URS does not attest to the accuracy, completeness, or reliability of geotechnical exploration and other subsurface data by others that are included or referenced in these plates.
 - These plans and stick-log plates are for the use and benefit of HDR, SBFCA, and their consultants in connection with the execution of the FRWL Project. Use by any other party is at their own discretion and risk. These figures should not be used as the sole basis for design, construction, remedial action, or major capital spending decisions.
 - The canal/ditch elevations are approximate. These elevations were estimated from the topography.

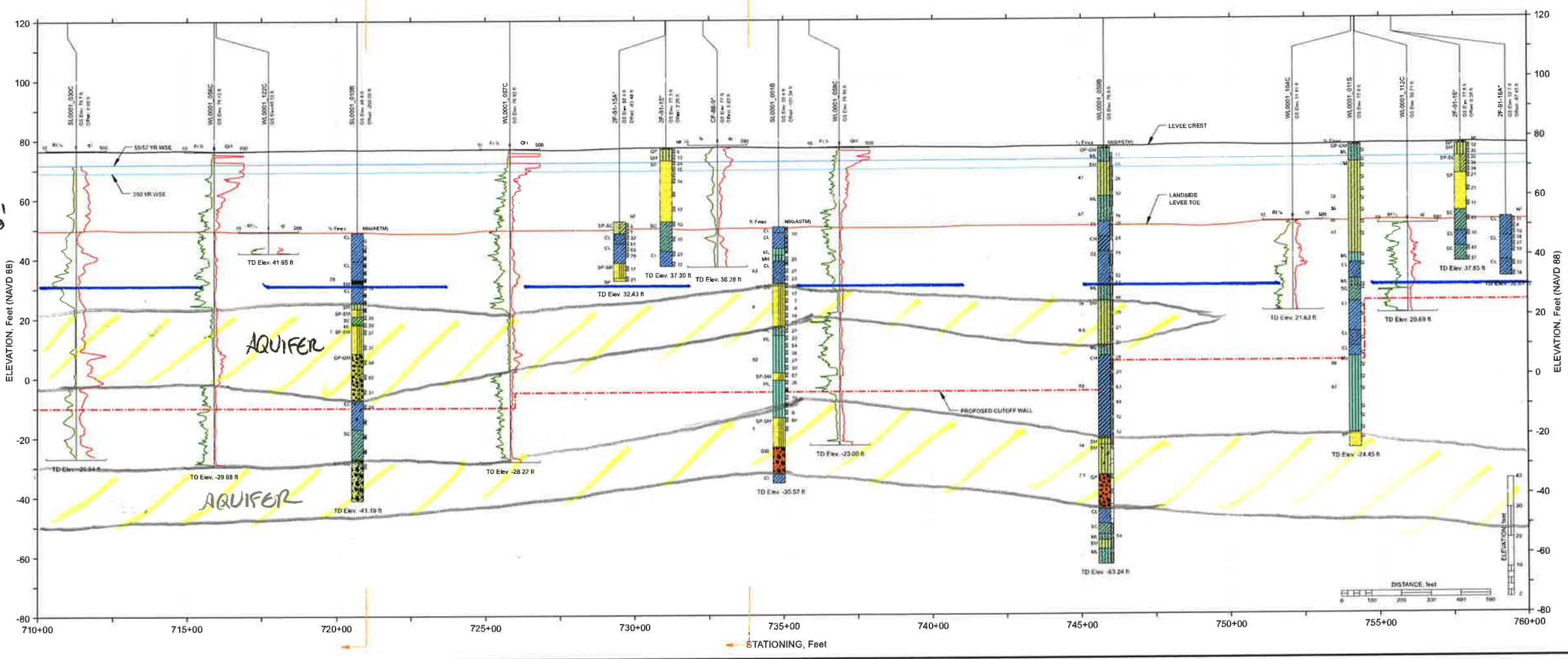

New WALL CUTS OFF UPPER AQUIFER FROM ~STA. 784+50 TO 827+50

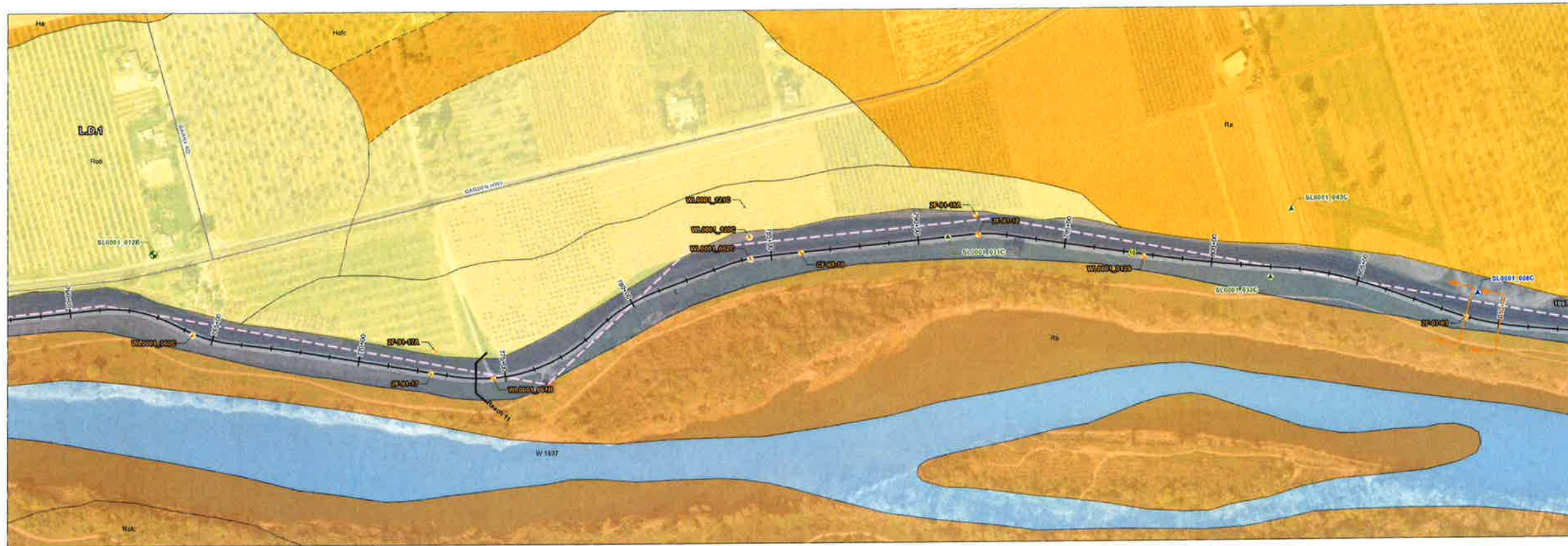

- NOTES:
1. Elevations of levee crown and landside toe are approximate. These elevations were obtained from DWR CVFED or ULE LIDAR data and used for geotechnical analyses and report purpose only. For detail crown elevation and landside toe information, please refer to the FRWL Project civil drawings.
 2. The water surface elevations are based on information provided by Peterson Brusted, Inc. in their July 26, 2012 report entitled "Design Water Surface Profiles for the Feather River West Levee Rehabilitation Project Addendum #1".
 3. Locations of explorations are approximate. Slick logs represent general soil conditions encountered at the time of exploration. For more detailed information on the materials encountered, refer to boring and CPT logs in the Geotechnical Data Report for the FRWL Project. No warranty is provided regarding the continuity of soil conditions between individual explorations.
 4. When reported, $N_{60}(ASTM)$, refers to $N_{60}(ASTM) = N_{60} \times$ Hammer Efficiency (%). See Geotechnical Data Report for the FRWL Project for hammer efficiency data for individual borings.
 5. These drawings do not include all historical explorations on the profile view. Historical explorations from the DWR ULE project are shown; "other" historical explorations are identified by an asterisk (*) in the exploration ID. For these "other" historical borings, blow counts are field blow counts (N) and USCS classifications are visual classifications.
 6. USCS classification labels are not presented on the slick logs for soil lenses (thickness less than 1.5 feet).
 7. This is a color figure. Black and white reproduction should not be relied upon as data will be lost.
 8. To prevent scale distortion, this map should be printed on e-D size sheet (22x34 inches).
 9. Surficial geology was mapped at 1:20,000 scale. (Source: SGRD for DWR ULE Project, URS, 2010).
 10. The information provided in these plans and stick-log plates has been compiled from a variety of sources. URS does not attest to the accuracy, completeness, or reliability of geotechnical exploration and other subsurface data by others that are included or referenced in these plates.
 11. These plans and stick-log plates are for the use and benefit of HDR, SBFCA, and their consultants in connection with the execution of the FRWL Project. Use by any other party is at their own discretion and risk. These figures should not be used as the sole basis for design, construction, remedial action, or major capital spending decisions.
 12. The cantalich elevations are approximate. These elevations were estimated from the topography.

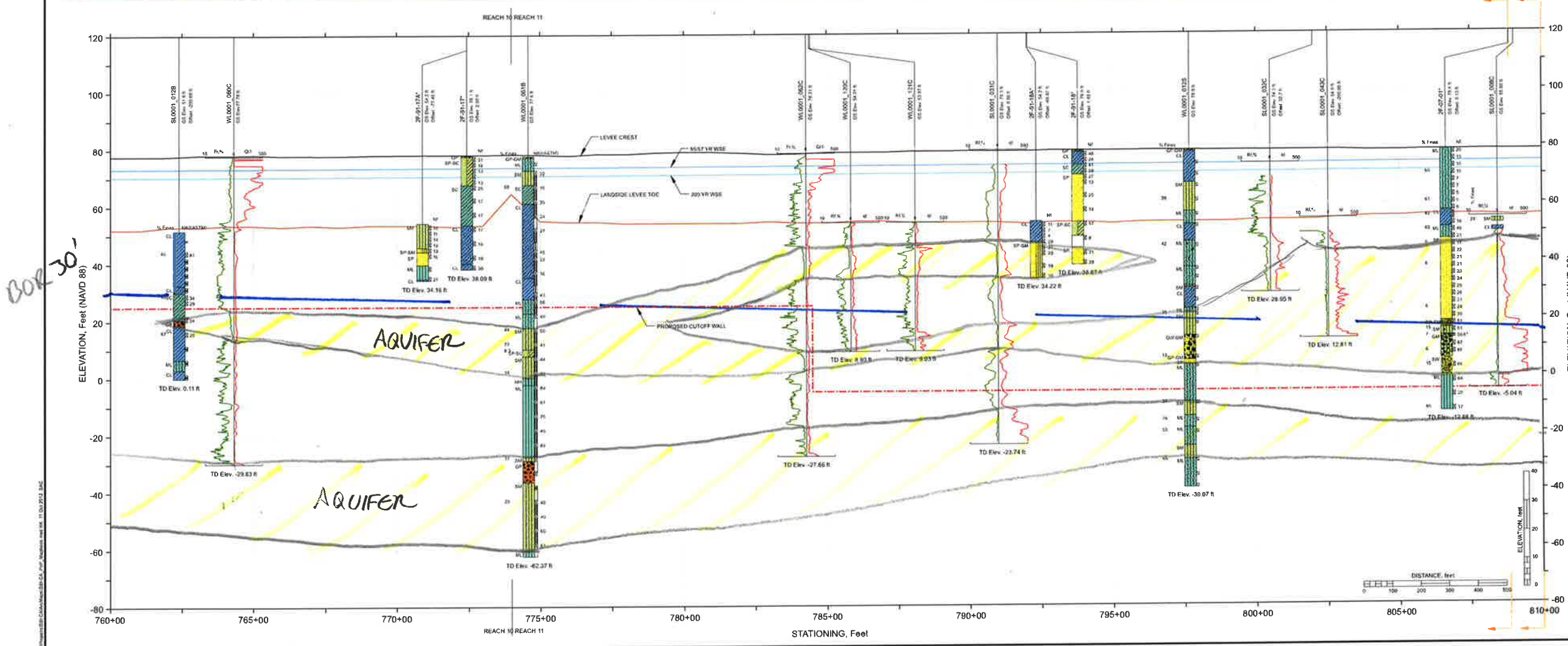

NEW WALL CUTS OFF UPPER AND LARGE PORTION OF DEEPAQUIFER FROM 844+50 TO 847+50

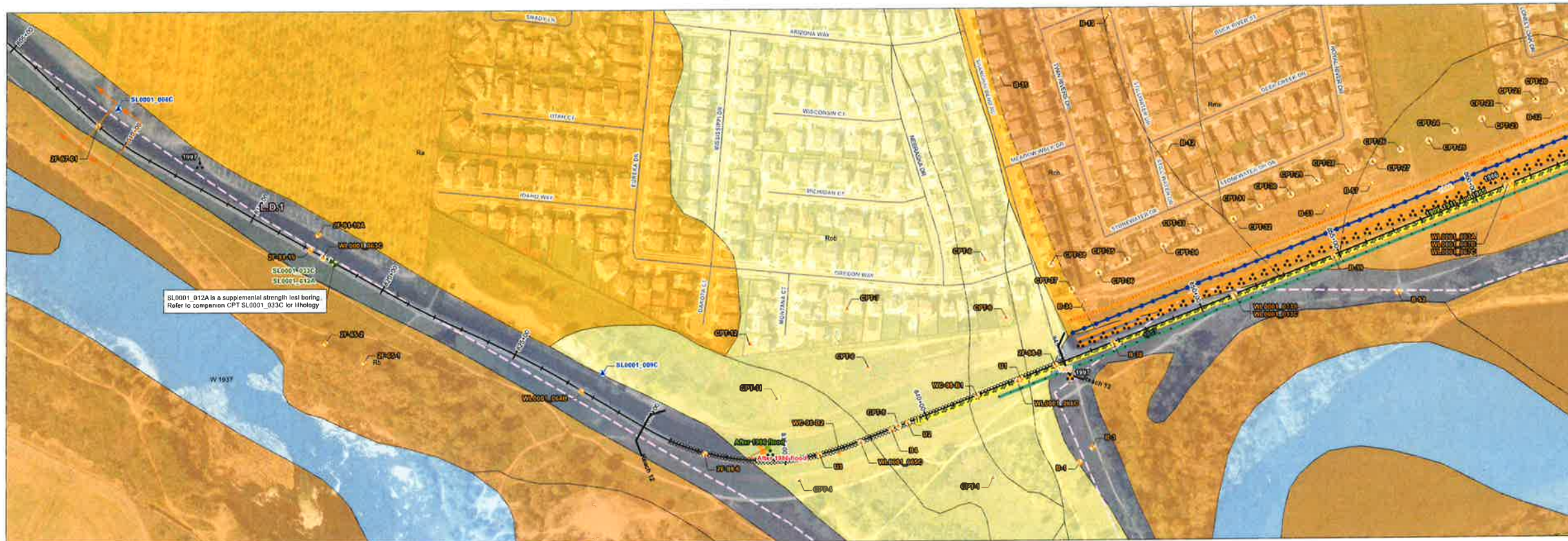

- 0 100 200 Feet
- NOTES:
- Elevations of levee crown and landside toe are approximate. These elevations were obtained from DWR CVFED or ULE LIDAR data and used for geotechnical analyses and report purpose only. For detail crown elevation and landside toe information, please refer to the FRWL Project civil drawings.
 - The water surface elevations are based on information provided by Pelarson Brustad, Inc. in their July 25, 2012 report entitled "Design Water Surface Profiles for the Feather River West Levee Rehabilitation Project Addendum #1".
 - Locations of explorations are approximate. Stick logs represent general soil conditions encountered at the time of exploration. For more detailed information on the materials encountered, refer to boring and CPT logs in the Geotechnical Data Report for the FRWL Project. No warranty is provided regarding the continuity of soil conditions between individual explorations.
 - When reported, $N_{60}(ASTM)$ refers to $N_{60}(ASTM) = N_{60} * \text{Hammer Efficiency } (\%)$. See Geotechnical Data Report for the FRWL Project for hammer efficiency data for individual borings.
 - These drawings do not include all historical explorations on the profile view. Historical explorations from the DWR ULE project are shown; other historical explorations are identified by an asterisk (*) in the exploration ID. For these "other" historical borings, blow counts are field blow counts (N) and USCS classifications are visual classifications.
 - USCS classification labels are not presented on the stick logs for soil lenses (thickness less than 1.5 feet).
 - This is a color figure. Black and white reproduction should not be relied upon as data will be lost.
 - To prevent scale distortion, this map should be printed on a 'D' size sheet (22x34 inches).
 - Surficial geology was mapped at 1:20,000 scale. (Source: SGRD for DWR ULE Project, URS, 2010).
 - The information provided in these plans and stick-log plates has been compiled from a variety of sources. URS does not attest to the accuracy, completeness, or reliability of geotechnical exploration and other subsurface data by others that are included or referenced in these plates.
 - These plans and stick-log plates are for the use and benefit of HDR, SBFCA, and their consultants in connection with the execution of the FRWL Project. Use by any other party is at their own discretion and risk. These figures should not be used as the sole basis for design, construction, remedial action, or major capital spending decisions.
 - The canalstick elevations are approximate. These elevations were estimated from the topography.

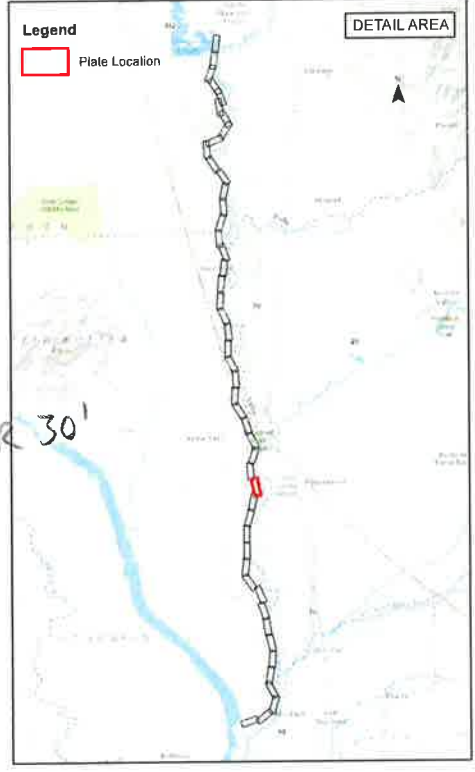
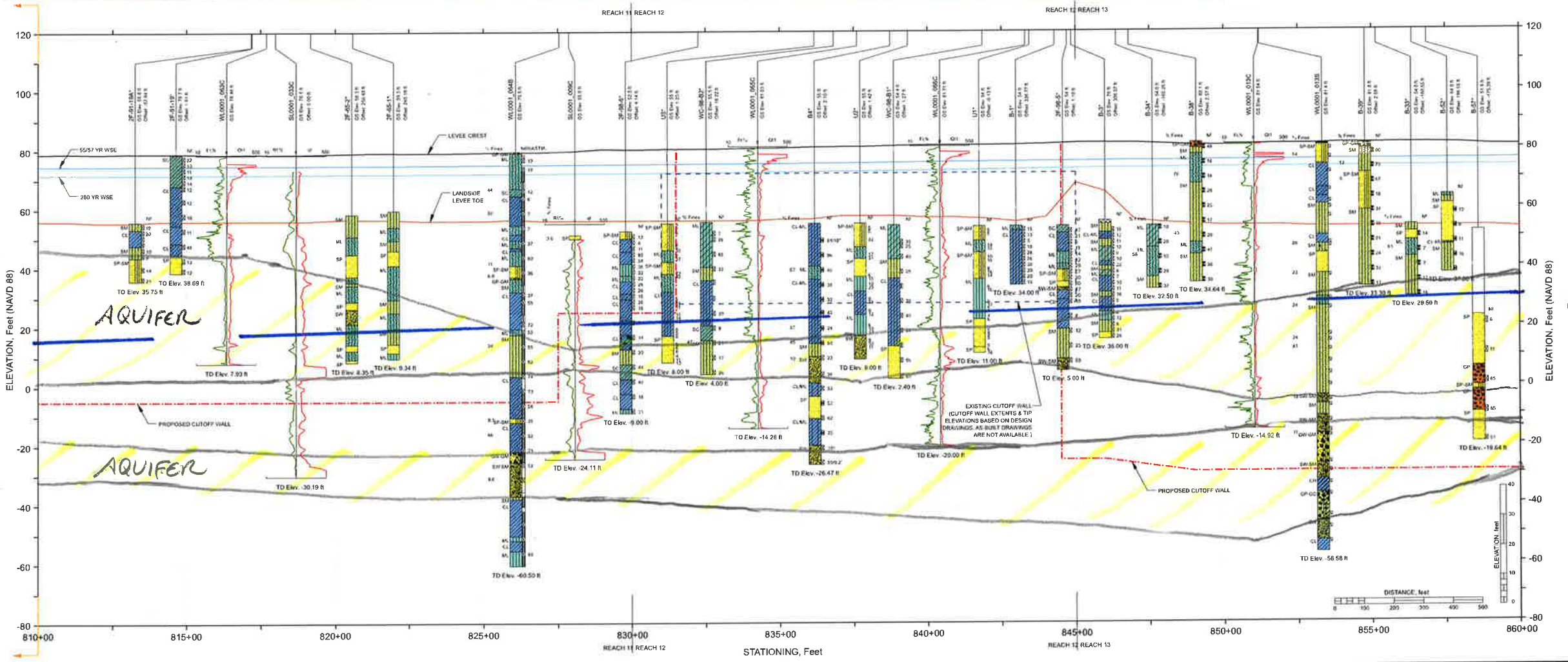

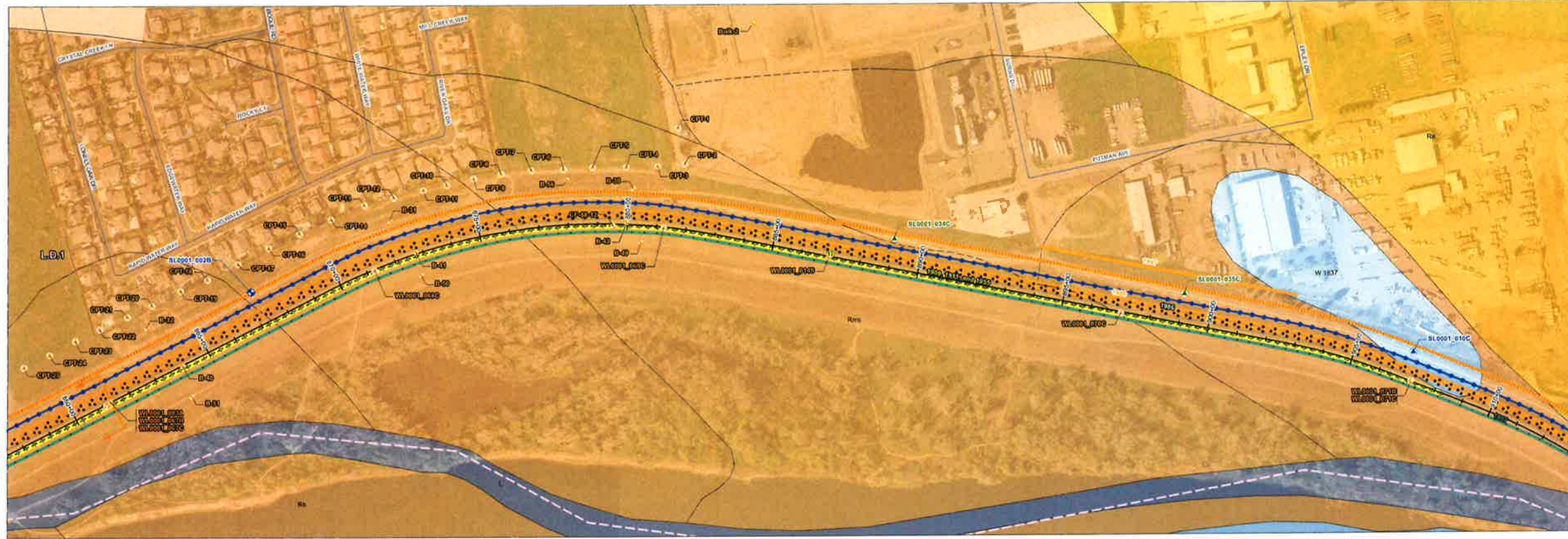

- 0 100 200

 Feet
- NOTES:
- Elevations of levee crown and landside toe are approximate. These elevations were obtained from DWR CVFED or ULE LIDAR data and used for geotechnical analyses and report purpose only. For detail crown elevation and landside toe information, please refer to the FRWL Project civil drawings.
 - The water surface elevations are based on information provided by Peterson Brustad, Inc. in their July 26, 2012 report entitled "Design Water Surface Profiles for the Feather River West Levee Rehabilitation Project Addendum #1".
 - Locations of explorations are approximate. Stick logs represent general soil conditions encountered at the time of exploration. For more detailed information on the materials encountered, refer to boring and CPT logs in the Geotechnical Data Report for the FRWL Project. No warranty is provided regarding the continuity of soil conditions between individual explorations.
 - When reported, $N_{60}(ASTM)$, refers to $N_{60}(ASTM) = N_{60} \times \text{Hammer Efficiency } (\%)$. See Geotechnical Data Report for the FRWL Project for hammer efficiency data for individual borings.
 - These drawings do not include all historical explorations on the profile view. Historical explorations from the DWR ULE project are shown; "other" historical explorations are identified by an asterisk (*) in the exploration ID. For these "other" historical borings, blow counts are field blow counts (NF) and USCS classifications are visual classifications.
 - USCS classification labels are not presented on the stick logs for soil lenses (thickness less than 1.5 feet).
 - This is a color figure. Black and white reproduction should not be relied upon as data will be lost.
 - To prevent scale distortion, this map should be printed on a "D" size sheet (22x34 inches).
 - Surficial geology was mapped at 1:20,000 scale. (Source: SGRD for DWR ULE Project, URS, 2010).
 - The information provided in these plans and stick-log plates has been compiled from a variety of sources. URS does not attest to the accuracy, completeness, or reliability of geotechnical exploration and other subsurface data by others that are included or referenced in these plates.
 - These plans and stick-log plates are for the use and benefit of HDR, SBFA, and their consultants in connection with the execution of the FRWL Project. Use by any other party is at their own discretion and risk. These figures should not be used as the sole basis for design, construction, remedial action, or major capital spending decisions.
 - The canal/ditch elevations are approximate. These elevations were estimated from the topography.

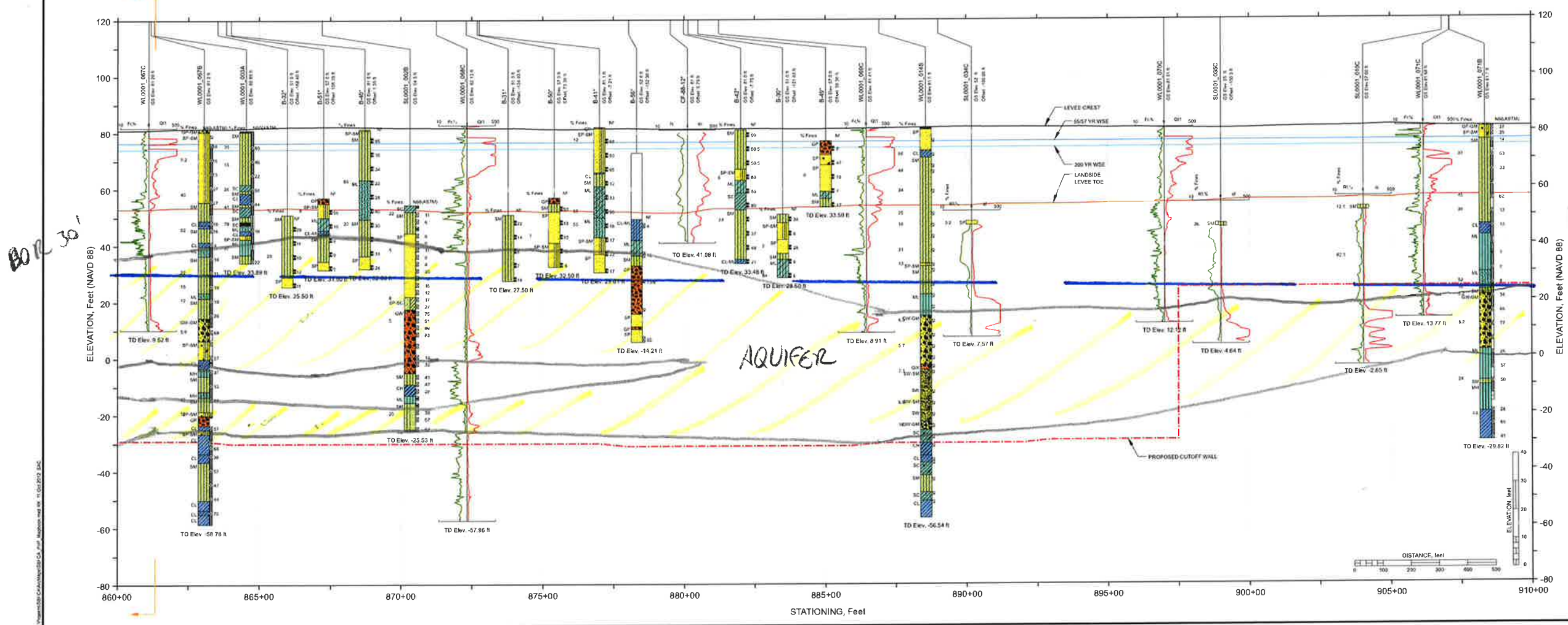

FRWL Project Plan Views and Stick Log Figures
FRWL Project: Station 860+00 to Station 910+00

Geotechnical Design
 Recommendations Report

Sutter Butte Flood Control Agency
 FEATHER RIVER WEST LEVEE PROJECT

Appendix A20



- NOTES:
- Elevations of levee crown and landside toe are approximate. These elevations were obtained from DWR CVFED or ULE LIDAR data and used for geotechnical analyses and report purposes only. For detail crown elevation and landside toe information, please refer to the FRWL Project civil drawings.
 - The water surface elevations are based on information provided by Peterson Brustad, Inc. in their July 26, 2012 report entitled "Design Water Surface Profiles for the Feather River West Levee Rehabilitation Project Addendum #1".
 - Locations of explorations are approximate. Stick logs represent general soil conditions encountered at the line of exploration. For more detailed information on the materials encountered, refer to boring and CPT logs in the Geotechnical Data Report for the FRWL Project. No warranty is provided regarding the continuity of soil conditions between individual explorations.
 - When reported, $N_{60}(ASTM)$ refers to $N_{60}(ASTM) = N_{60} * \text{Hammer Efficiency} (\%)$. See Geotechnical Data Report for the FRWL Project for hammer efficiency data for individual borings.
 - These drawings do not include all historical explorations on the profile view. Historical explorations from the DWR ULE project are shown; "other" historical explorations are identified by an asterisk (*) in the exploration ID. For these "other" historical borings, blow counts are field blow counts (NF) and USCS classifications are visual classifications.
 - USCS classification labels are not presented on the stick logs for soil lenses (thickness less than 1.5 feet).
 - This is a color figure. Black and white reproduction should not be relied upon as data will be lost.
 - To prevent scale distortion, this map should be printed on a D' size sheet (22x34 inches).
 - Surficial geology was mapped at 1:20,000 scale. (Source: SGDR for DWR ULE Project, URS, 2010).
 - The information provided in these plans and stick-log plates has been compiled from a variety of sources. URS does not attest to the accuracy, completeness, or reliability of geotechnical exploration and other subsurface data by others that are included or referenced in these plans.
 - These plans and stick-log plates are for the use and benefit of HDR, SBFA, and their consultants in connection with the execution of the FRWL Project. Use by any other party is at their own discretion and risk. These figures should not be used as the sole basis for design, construction, remedial action, or major capital spending decisions.
 - The canal ditch elevations are approximate. These elevations were estimated from the topography.

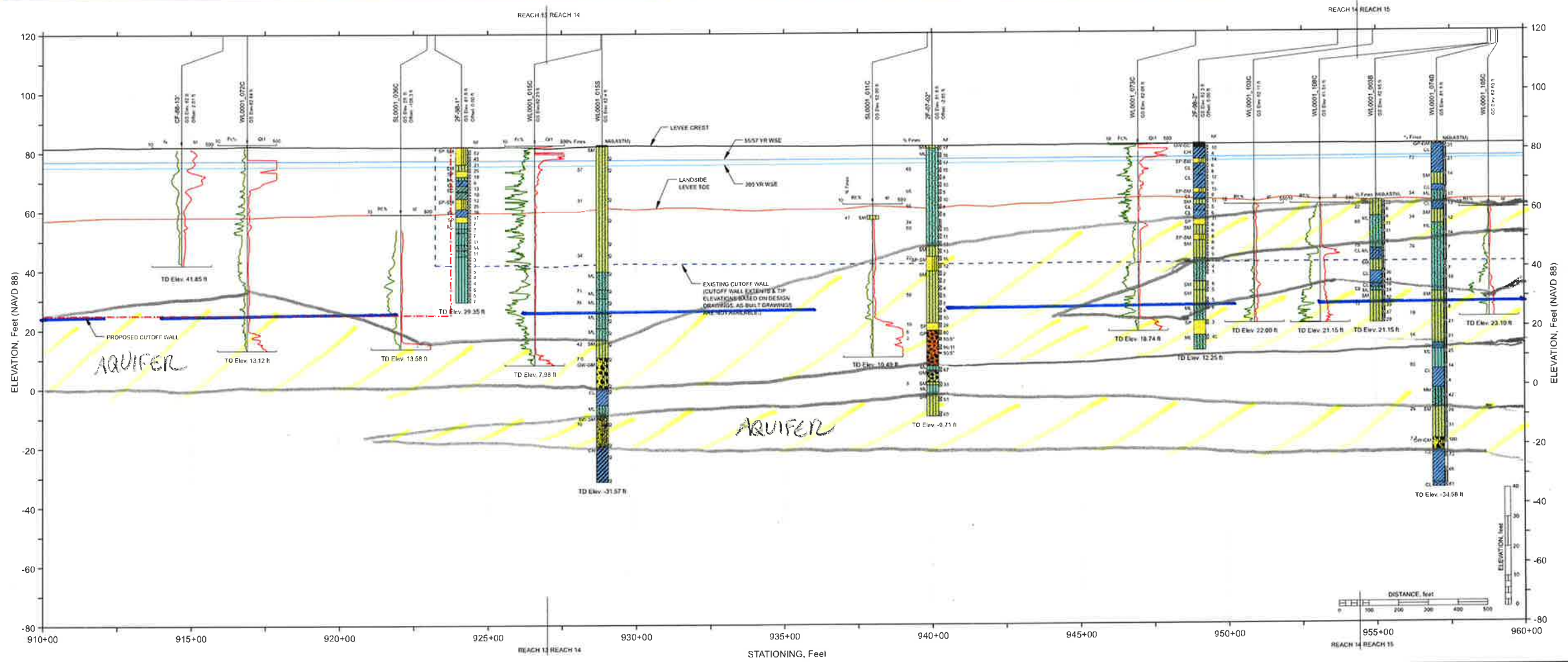

FRWL Project Plan Views and Stick Log Figures
FRWL Project: Station 910+00 to Station 960+00



- NOTES:
- Elevations of levee crown and landside toe are approximate. These elevations were obtained from DWR CVFED or ULE LIDAR data and used for geotechnical analyses and report purpose only. For detail crown elevation and landside toe information, please refer to the FRWL Project civil drawings.
 - The water surface elevations are based on information provided by Peterson Brustad, Inc. in their July 26, 2012 report entitled "Design Water Surface Profiles for the Feather River West Levee Rehabilitation Project Addendum #1".
 - Locations of explorations are approximate. Stick logs represent general soil conditions encountered at the time of exploration. For more detailed information on the materials encountered, refer to boring and CPT logs in the Geotechnical Data Report for the FRWL Project. No warranty is provided regarding the continuity of soil conditions between individual explorations.
 - When reported, $N_{60}(ASTM)$ refers to $N_{60}(ASTM) = N_{60} \times$ Hammer Efficiency (%). See Geotechnical Data Report for the FRWL Project for hammer efficiency data for individual borings.
 - These drawings do not include all historical explorations on the profile view. Historical explorations from the DWR ULE project are shown; "other" historical explorations are identified by an asterisk (*) in the exploration ID. For these "other" historical borings, blow counts are field blow counts (NF) and USCS classifications are visual classifications.
 - USCS classification labels are not presented on the stick logs for soil lenses (thickness less than 1.5 feet).
 - This is a color figure. Black and white reproduction should not be relied upon as data will be lost.
 - To prevent scale distortion, this map should be printed on a "D" size sheet (22x34 inches).
 - Surficial geology was mapped at 1:20,000 scale. (Source: SGR for DWR ULE Project, URS, 2010).
 - The information provided in these plans and stick-log plates has been compiled from a variety of sources. URS does not attest to the accuracy, completeness, or reliability of geotechnical exploration and other subsurface data by others that are included or referenced in these plates.
 - These plans and stick-log plates are for the use and benefit of HDR, SBFCA, and their consultants in connection with the execution of the FRWL Project. Use by any other party is at their own discretion and risk. These figures should not be used as the sole basis for design, construction, remedial action, or major capital spending decisions.
 - The canal/ditch elevations are approximate. These elevations were estimated from the topography.

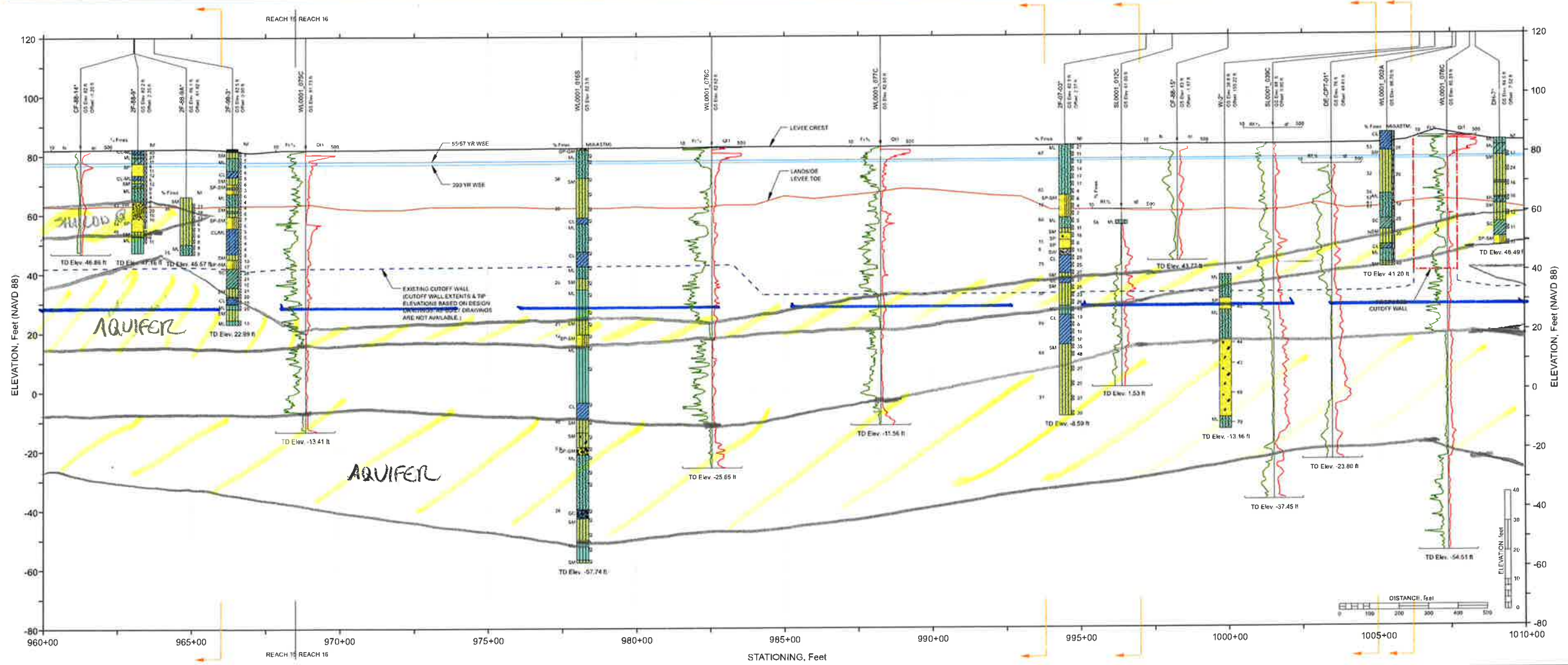

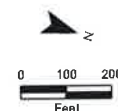
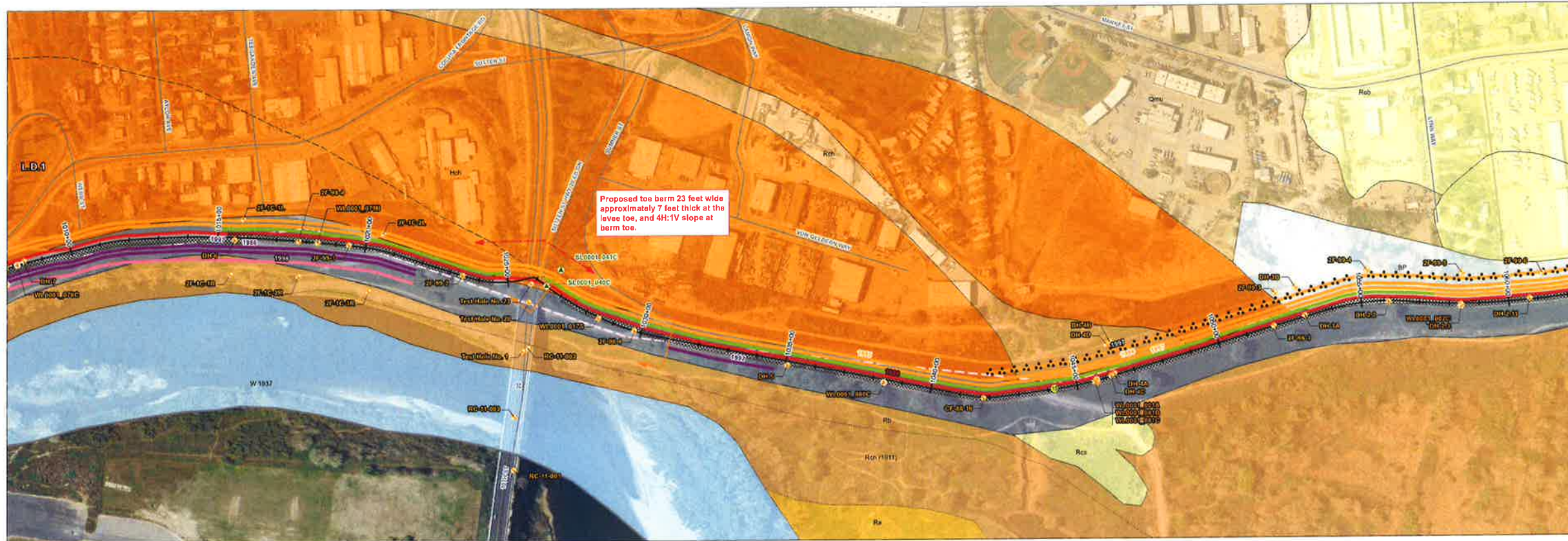

- NOTES:
- Elevations of levee crown and landside toe are approximate. These elevations were obtained from DWR CVFED or ULE LIDAR data and used for geotechnical analyses and report purpose only. For detail crown elevation and landside toe information, please refer to the FRWL Project civil drawings.
 - The water surface elevations are based on information provided by Peterson Brustad, Inc. in their July 26, 2012 report entitled "Design Water Surface Profiles for the Feather River West Levee Rehabilitation Project Addendum #1".
 - Locations of explorations are approximate. Stick logs represent general soil conditions encountered at the time of exploration. For more detailed information on the materials encountered, refer to boring and CPT logs in the Geotechnical Data Report for the FRWL Project. No warranty is provided regarding the continuity of soil conditions between individual explorations.
 - When reported, $N_{60}(ASTM)$ refers to $N_{60}(ASTM) = N_{60} \cdot \text{Hammer Efficiency} (\%)$. See Geotechnical Data Report for the FRWL Project for hammer efficiency data for individual borings.
 - These drawings do not include all historical explorations on the profile view. Historical explorations from the DWR ULE project are shown; "other" historical explorations are identified by an asterisk (*) in the exploration ID. For these "other" historical borings, blow counts are field blow counts (N) and USCS classifications are visual classifications.
 - USCS classification labels are not presented on the stick logs for soil lenses (thickness less than 1.5 feet).
 - This is a color figure. Black and white reproduction should not be relied upon as data will be lost.
 - To prevent scale distortion, this map should be printed on a "D" size sheet (22x34 inches).
 - Soil geology was mapped at 1:20,000 scale. (Source: SGRD for DWR ULE Project, URS, 2010).
 - The information provided in these plans and stick-log plates has been compiled from a variety of sources. URS does not attest to the accuracy, completeness, or reliability of geotechnical exploration and other subsurface data by others that are included or referenced in these plates.
 - These plans and stick-log plates are for the use and benefit of HDR, SBFCA, and their consultants in connection with the execution of the FRWL Project. Use by any other party is at their own discretion and risk. These figures should not be used as the sole basis for design, construction, remedial action, or major capital spending decisions.
 - The canal/ditch elevations are approximate. These elevations were estimated from the topography.

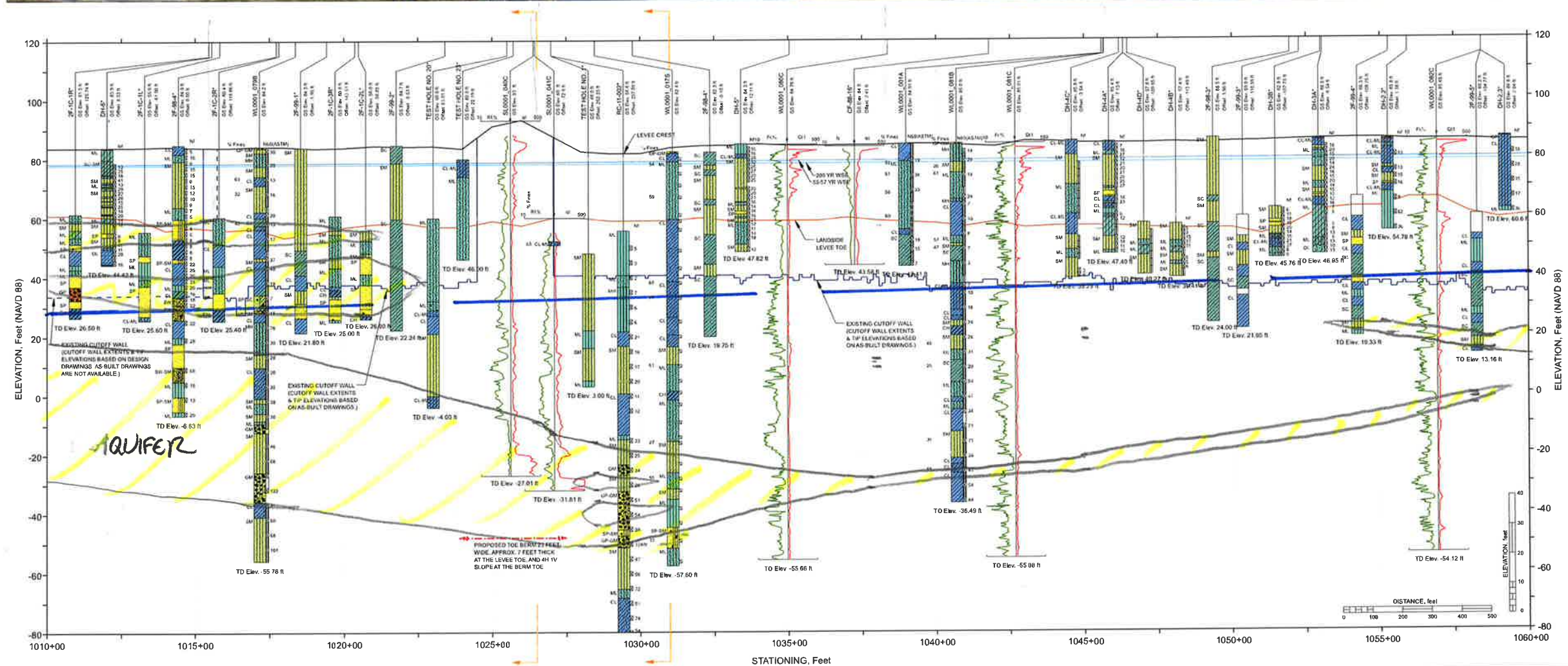

FRWL Project Plan Views and Stick Log Figures
FRWL Project: Station 1010+00 to Station 1060+00

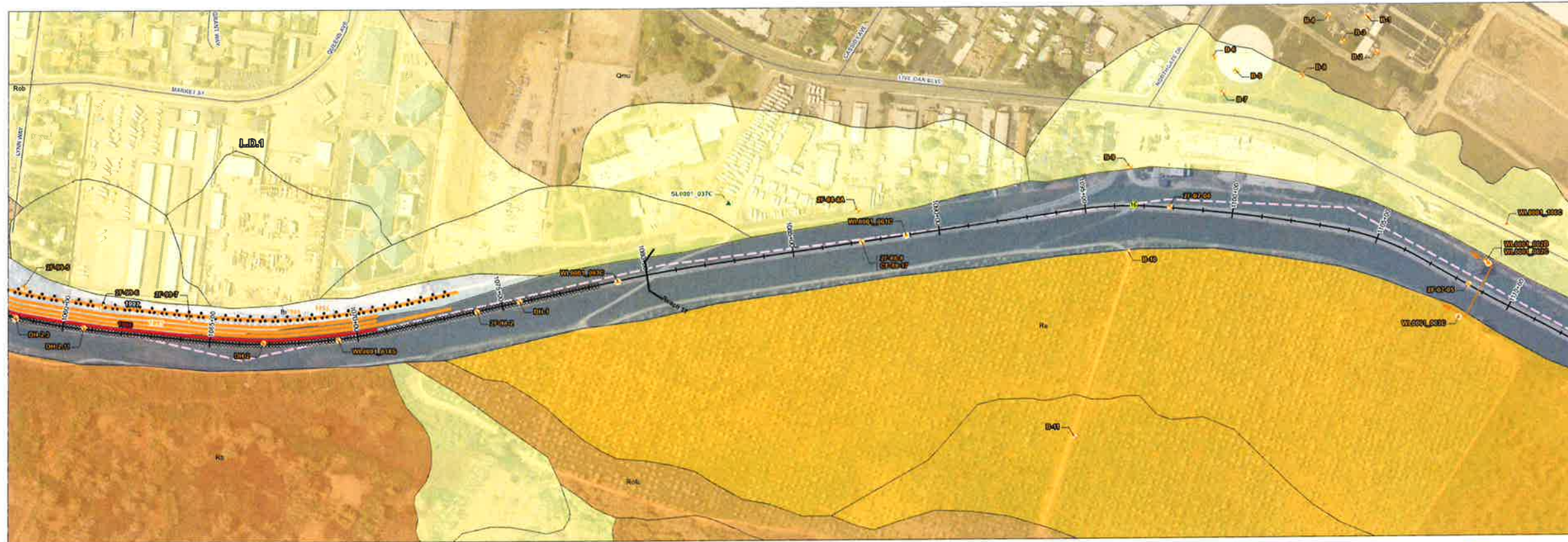

- 0 100 200
Feet
- NOTES:
- Elevations of levee crown and landside toe are approximate. These elevations were obtained from DWR CVFED or ULE LIDAR data and used for geotechnical analyses and report purpose only. For detail crown elevation and landside toe information, please refer to the FRWL Project civil drawings.
 - The water surface elevations are based on information provided by Peterson Brustad, Inc. in their July 26, 2012 report entitled "Design Water Surface Profiles for the Feather River West Levee Rehabilitation Project Addendum #1".
 - Locations of explorations are approximate. Stick logs represent general soil conditions encountered at the time of exploration. For more detailed information on the materials encountered, refer to boring and CPT logs in the Geotechnical Data Report for the FRWL Project. No warranty is provided regarding the continuity of soil conditions between individual explorations.
 - When reported, $N_{60}(ASTM)$ refers to $N_{60}(ASTM) = N_{60} \times \text{Hammer Efficiency } (\%)$. See Geotechnical Data Report for the FRWL Project for hammer efficiency data for individual borings.
 - These drawings do not include all historical explorations on the profile view. Historical explorations from the DWR ULE project are shown; "other" historical explorations are identified by an asterisk (*) in the exploration ID. For these "other" historical borings, blow counts are field blow counts (N) and USCS classifications are visual classifications.
 - USCS classification labels are not presented on the stick logs for soil lenses (thickness less than 1.5 feet).
 - This is a color figure. Black and white reproduction should not be relied upon as data will be lost.
 - To prevent scale distortion, this map should be printed on a 'D' size sheet (22x34 inches).
 - Surficial geology was mapped at 1:20,000 scale. (Source: SGDR for DWR ULE Project, URS, 2010).
 - The information provided in these plans and stick-log plates has been compiled from a variety of sources. URS does not attest to the accuracy, completeness, or reliability of geotechnical exploration and other subsurface data by others that are included or referenced in these plates.
 - These plans and stick-log plates are for the use and benefit of HDR, SBFA, and their consultants in connection with the execution of the FRWL Project. Use by any other party is at their own discretion and risk. These figures should not be used as the sole basis for design, construction, remediation, or major capital spending decisions.
 - The canal ditch elevations are approximate. These elevations were estimated from the topography.

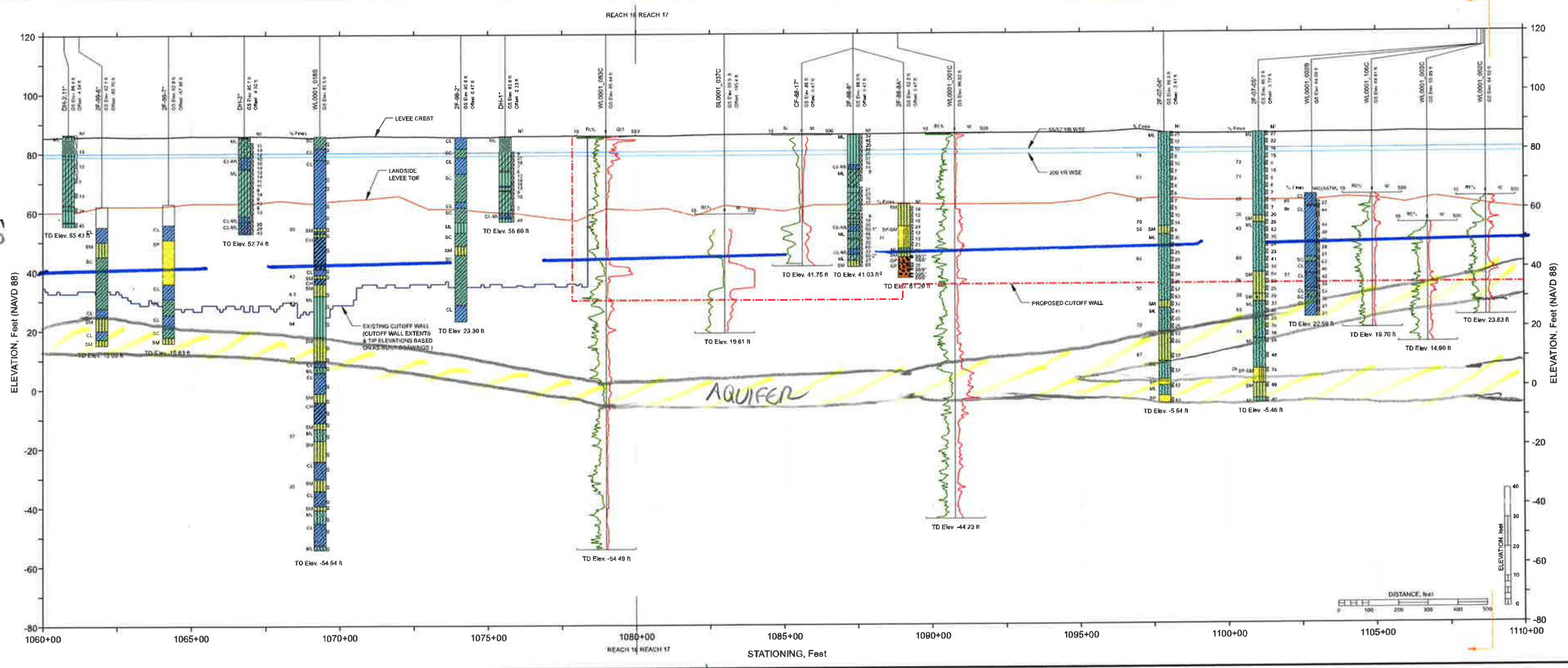

NEW WALL CWS OF UPPER AQUIFER

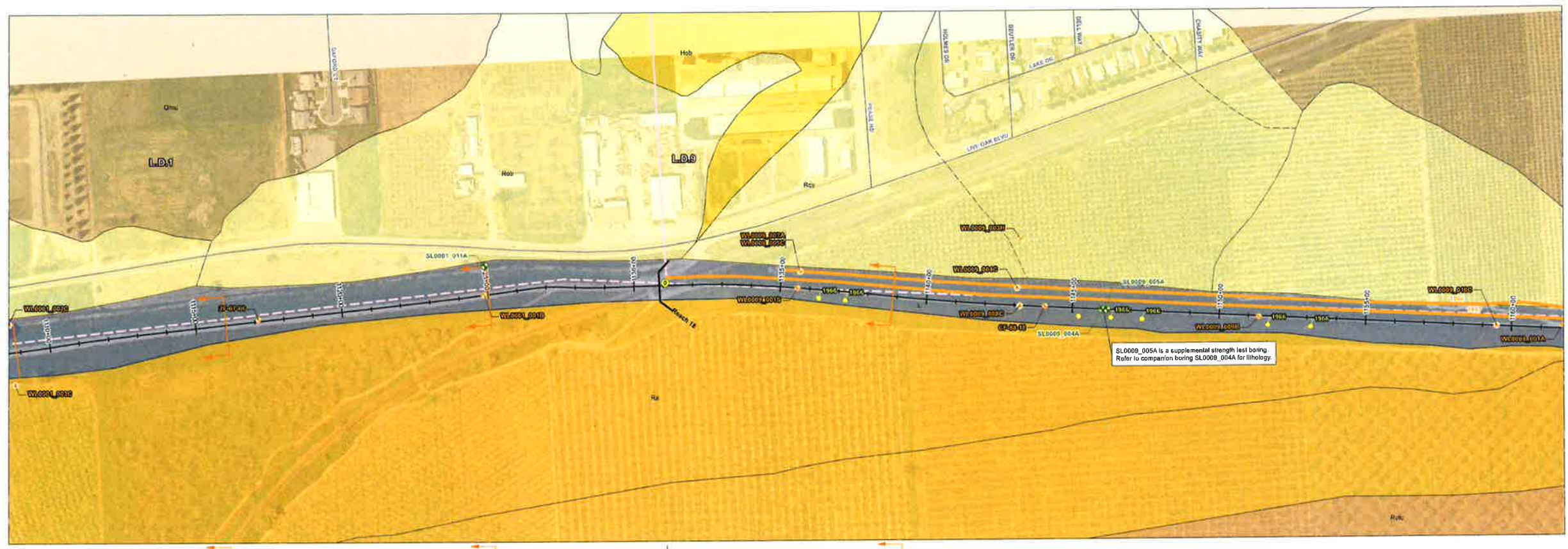

- 0 100 200 Feet
- NOTES:
- Elevations of levee crown and landside toe are approximate. These elevations were obtained from DWR CVFED or ULE LIDAR data and used for geotechnical analyses and report purpose only. For detail crown elevation and landside toe information, please refer to the FRWL Project civil drawings.
 - The water surface elevations are based on information provided by Peterson Brustad, Inc. in their July 26, 2012 report entitled "Design Water Surface Profiles for the Feather River West Levee Rehabilitation Project Addendum #1".
 - Locations of explorations are approximate. Stick logs represent general soil conditions encountered at the time of exploration. For more detailed information on the materials encountered, refer to boring and CPT logs in the Geotechnical Data Report for the FRWL Project. No warranty is provided regarding the continuity of soil conditions between individual explorations.
 - When reported, $N_{60}(ASTM)$ refers to $N_{60}(ASTM) = N_{60} \times \text{Hammer Efficiency} (\%)$. See Geotechnical Data Report for the FRWL Project for hammer efficiency data for individual borings.
 - These drawings do not include all historical explorations on the profile view. Historical explorations from the DWR ULE project are shown; "other" historical explorations are identified by an asterisk (*) in the exploration ID. For these "other" historical borings, blow counts are field blow counts (N) and USCS classifications are visual classifications.
 - USCS classification labels are not present on the stick logs for soil lenses (thickness less than 1.5 feet).
 - This is a color figure. Black and white reproduction should not be relied upon as data will be lost.
 - To prevent scale distortion, this map should be printed on a 'D' size sheet (22x34 inches).
 - Surficial geology was mapped at 1:20,000 scale. (Source: SGDR for DWR ULE Project, URS, 2010).
 - The information provided in these plans and stick-log plates has been compiled from a variety of sources. URS does not attest to the accuracy, completeness, or reliability of geotechnical exploration and other subsurface data by others that are included or referenced in these plates.
 - These plans and stick-log plates are for the use and benefit of HDR, SBFCA, and their consultants in connection with the execution of the FRWL Project. Use by any other party is at their own discretion and risk. These figures should not be used as the sole basis for design, construction, remedial action, or major capital spending decisions.
 - The canal/itch elevations are approximate. These elevations were estimated from the topography.

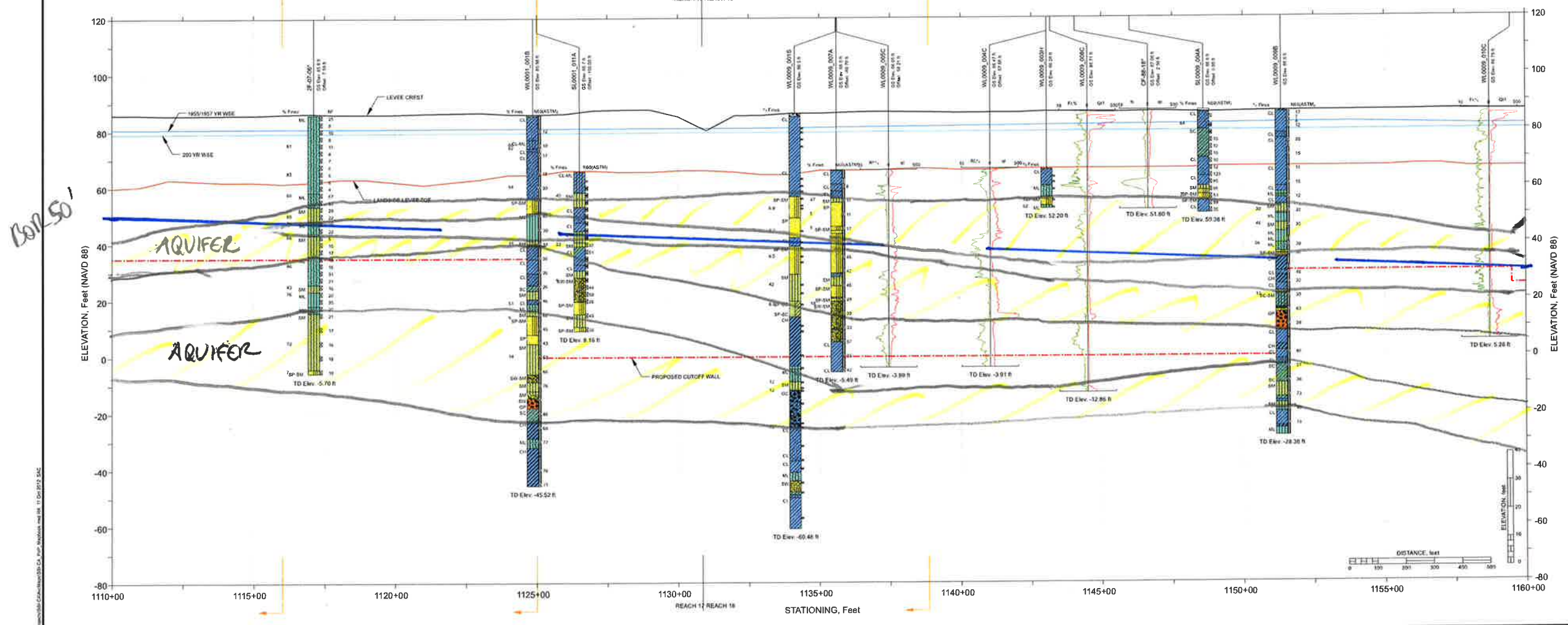

FRWL Project Plan Views and Stick Log Figures
FRWL Project: Station 1110+00 to Station 1160+00

NEW WALL CUTS OFF UPPER AQUIFER



- 0 100 200 Feet
- NOTES:
- Elevations of levee crown and landside toe are approximate. These elevations were obtained from DWR CVFED or ULE LIDAR data and used for geotechnical analyses and report purposes only. For detail crown elevation and landside toe information, please refer to the FRWL Project civil drawings.
 - The water surface elevations are based on information provided by Peterson Brustad, Inc. in their July 26, 2012 report entitled "Design Water Surface Profiles for the Feather River West Levee Rehabilitation Project Addendum #1".
 - Locations of explorations are approximate. Stick logs represent general soil conditions encountered at the time of exploration. For more detailed information on the materials encountered, refer to boring and CPT logs in the Geotechnical Data Report for the FRWL Project. No warranty is provided regarding the continuity of soil conditions between individual explorations.
 - When reported, $N_{60}(ASTM)$ refers to $N_{60}(ASTM) = N_{60} \cdot \text{Hammer Efficiency} (\%)$. See Geotechnical Data Report for the FRWL Project for hammer efficiency data for individual borings.
 - These drawings do not include all historical explorations on the profile view. Historical explorations from the DWR ULE project are shown; "other" historical explorations are identified by an asterisk (*) in the exploration ID. For these "other" historical borings, blow counts are field blow counts (N) and USCS classifications are visual classifications.
 - USCS classification labels are not presented on the stick logs for soil lenses (thickness less than 1.5 feet).
 - This is a color figure. Black and white reproduction should not be relied upon as data will be lost.
 - To prevent scale distortion, this map should be printed on a 'D' size sheet (22x34 inches).
 - Surficial geology was mapped at 1:20,000 scale. (Source: SGDR for DWR ULE Project, URS, 2010).
 - The information provided in these plans and stick-log plates has been compiled from a variety of sources. URS does not attest to the accuracy, completeness, or reliability of geotechnical exploration and other subsurface data by others that are included or referenced in these plans.
 - These plans and stick-log plates are for the use and benefit of HDR, SBFCA, and their consultants in connection with the execution of the FRWL Project. Use by any other party is at their own discretion and risk. These figures should not be used as the sole basis for design, construction, remediation, or major capital spending decisions.
 - The canal/itch elevations are approximate. These elevations were estimated from the topography.

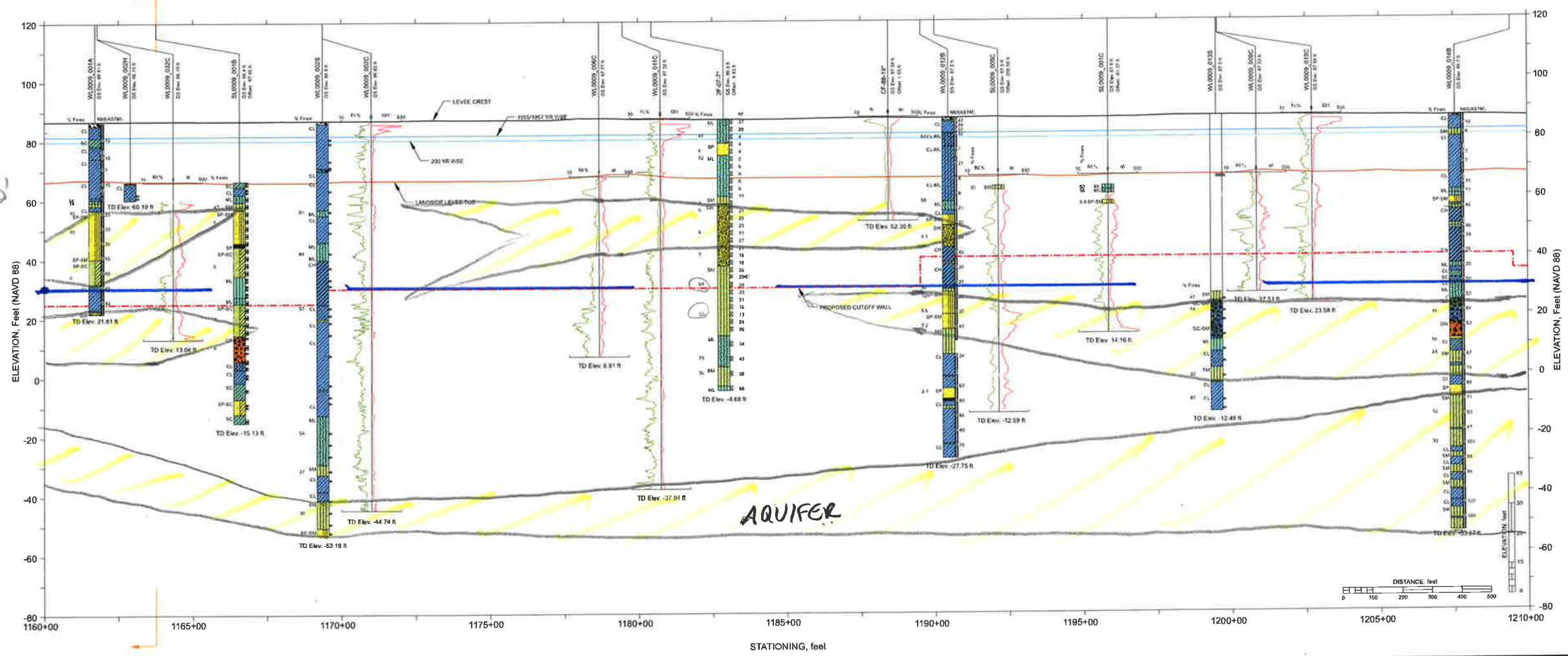

NEW WALL CUTS OFF AQUIFER

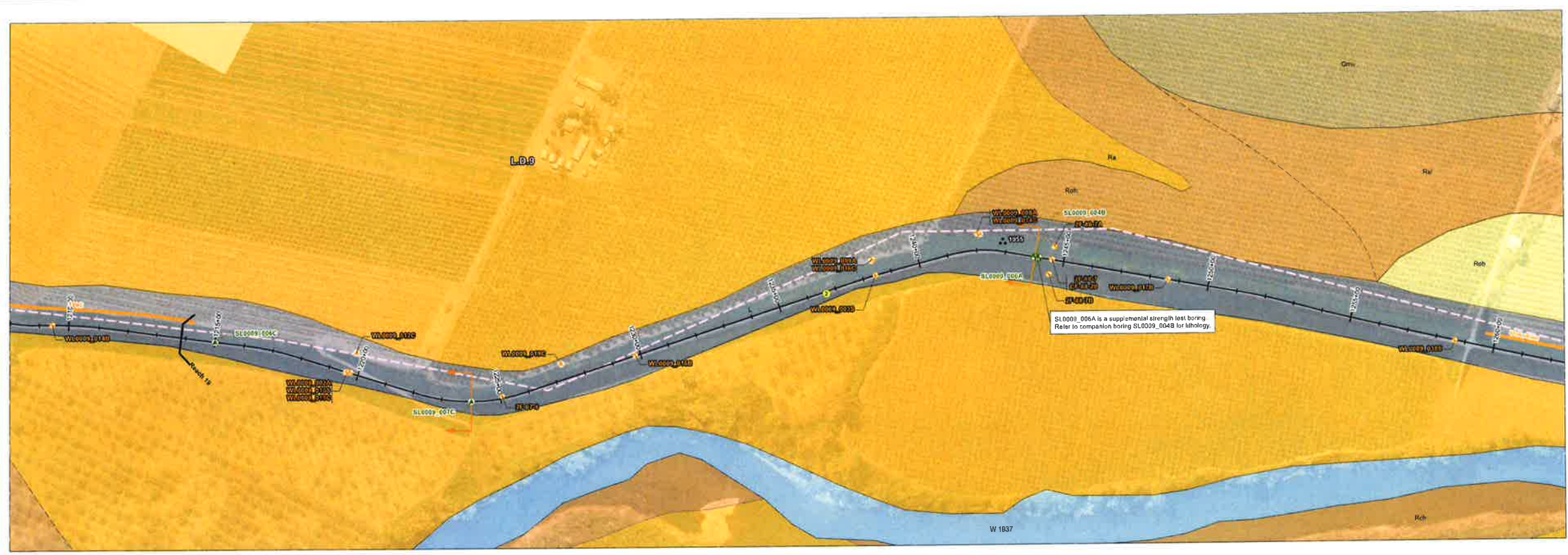

- NOTES:
- Elevations of levee crown and landside toe are approximate. These elevations were obtained from DWR CVFED or ULE LIDAR data and used for geotechnical analyses and report purpose only. For detail crown elevation and landside toe information, please refer to the FRWL Project civil drawings.
 - The water surface elevations are based on information provided by Peterson Bruslad, Inc. in their July 26, 2012 report entitled "Design Water Surface Profiles for the Feather River West Levee Rehabilitation Project Addendum #1".
 - Locations of explorations are approximate. Stick logs represent general soil conditions encountered at the time of exploration. For more detailed information on the materials encountered, refer to boring and CPT logs in the Geotechnical Data Report for the FRWL Project. No warranty is provided regarding the continuity of soil conditions between individual explorations.
 - When reported, N_{60} (ASTM) refers to N_{60} (ASTM) = N_{60} Hammer Efficiency (%). See Geotechnical Data Report for the FRWL Project for hammer efficiency data for individual borings.
 - These drawings do not include all historical explorations on the profile view. Historical explorations from the DWR ULE project are shown; "other" historical explorations are identified by an asterisk (*) in the exploration ID. For these "other" historical borings, blow counts are field blow counts (NF) and USCS classifications are visual classifications.
 - USCS classification labels are not presented on the stick logs for soil lenses (thickness less than 1.5 feet).
 - This is a color figure. Black and white reproduction should not be relied upon as data will be lost.
 - To prevent scale distortion, this map should be printed on a 'D' size sheet (22x34 inches).
 - Surficial geology was mapped at 1:20,000 scale. (Source: SGDR for DWR ULE Project, URS, 2010).
 - The information provided in these plans and stick-log plates has been compiled from a variety of sources. URS does not attest to the accuracy, completeness, or reliability of geotechnical exploration and other subsurface data by others that are included or referenced in these plates.
 - These plans and stick-log plates are for the use and benefit of HDR, SBFCA, and their consultants in connection with the execution of the FRWL Project. Use by any other party is at their own discretion and risk. These figures should not be used as the sole basis for design, construction, remedial action, or major capital spending decisions.
 - The canal/ditch elevations are approximate. These elevations were estimated from the topography.

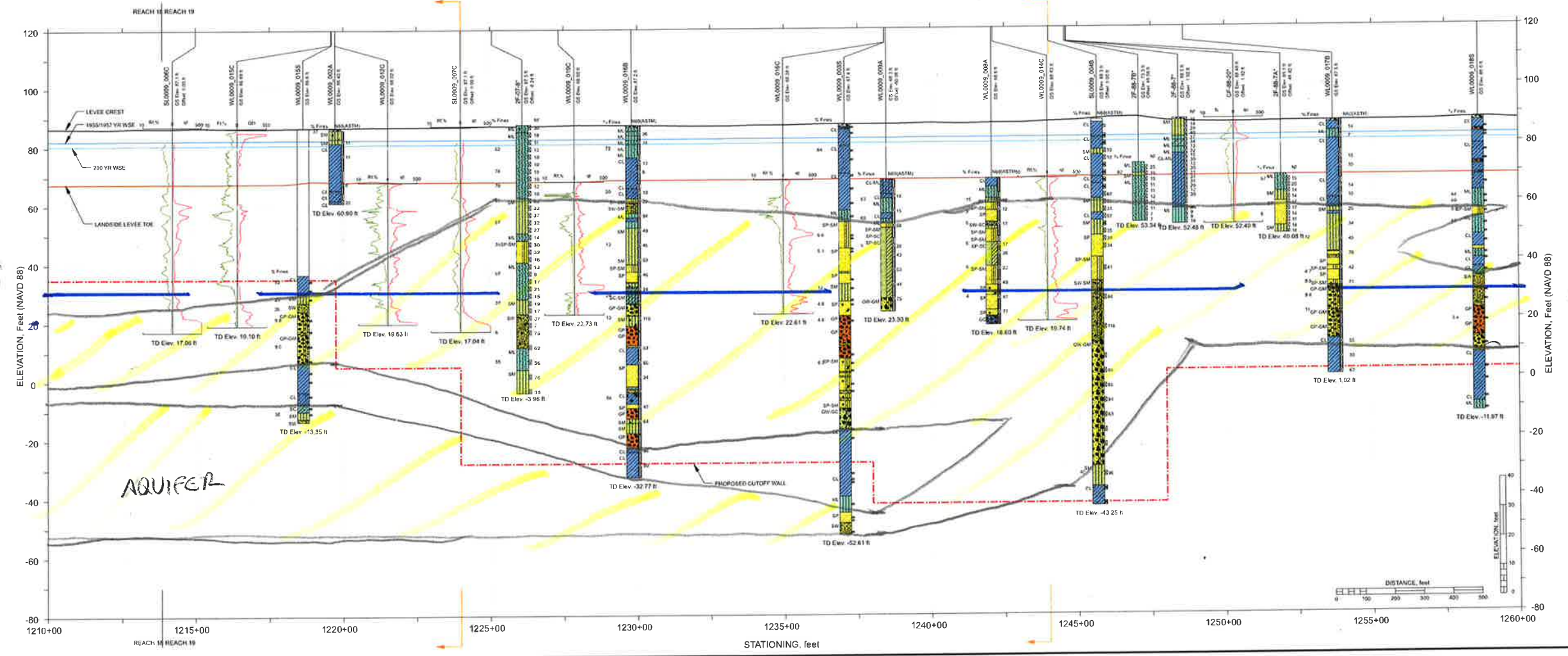

FRWL Project Plan Views and Stick Log Figures
FRWL Project: Station 1210+00 to Station 1260+00

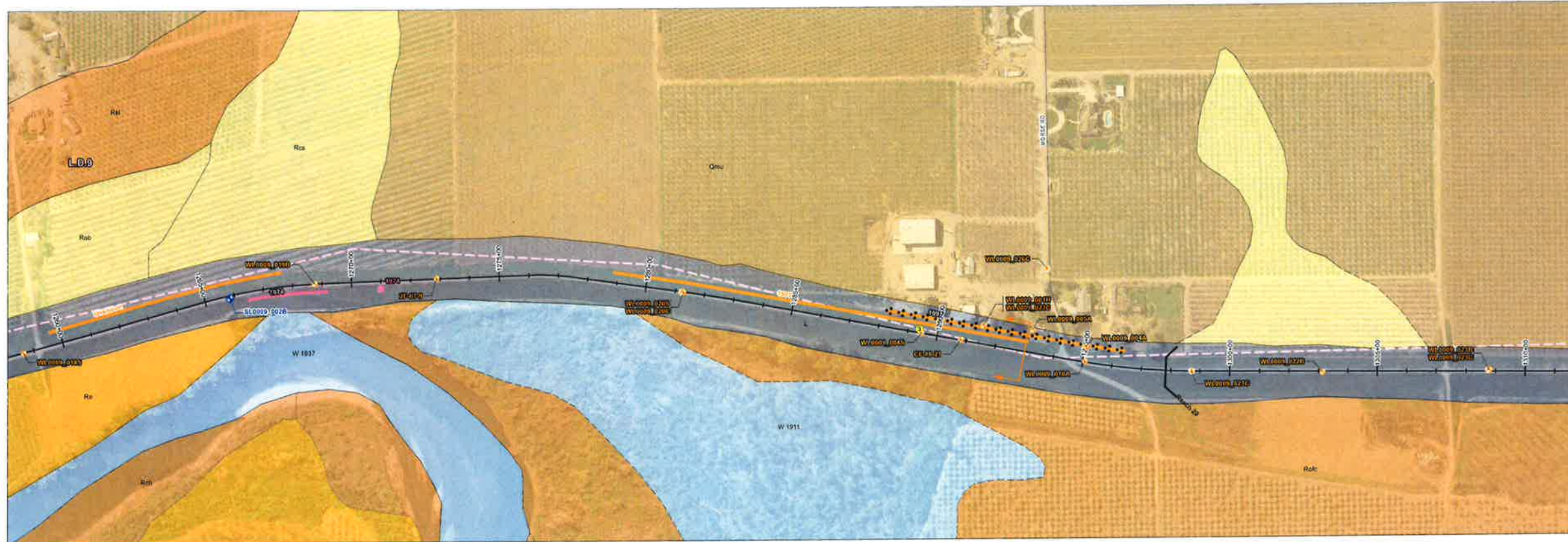

- NOTES:
1. Elevations of levee crown and landside toe are approximate. These elevations were obtained from DWR CVFED or ULE LIDAR data and used for geotechnical analysis and report purpose only. For detail crown elevation and landside toe information, please refer to the FRWL Project civil drawings.
 2. The water surface elevations are based on information provided by Peterson Brustad, Inc. in their July 26, 2012 report entitled "Design Water Surface Profiles for the Feather River West Levee Rehabilitation Project Addendum #1".
 3. Locations of explorations are approximate. Stick logs represent general soil conditions encountered at the time of exploration. For more detailed information on the materials encountered, refer to boring and CPT logs in the Geotechnical Data Report for the FRWL Project. No warranty is provided regarding the continuity of soil conditions between individual explorations.
 4. When reported, N_{60} (ASTM) refers to N_{60} (ASTM) = N_{60} * Hammer Efficiency (%). See Geotechnical Data Report for the FRWL Project for hammer efficiency data for individual borings.
 5. These drawings do not include all historical explorations on the profile view. Historical explorations from the DWR ULE project are shown; "other" historical explorations are identified by an asterisk (*) in the exploration ID. For these "other" historical borings, blow counts are field blow counts (N) and USCS classifications are visual classifications.
 6. USCS classification labels are not presented on the stick logs for soil lenses (thickness less than 1.5 feet).
 7. This is a color figure. Black and white reproduction should not be relied upon as data will be lost.
 8. To prevent scale distortion, this map should be printed on a "D" size sheet (22x34 inches).
 9. Surficial geology was mapped at 1:20,000 scale. (Source: SGRD for DWR ULE Project, URS, 2010).
 10. The information provided in these plans and stick-log plates has been compiled from a variety of sources. URS does not attest to the accuracy, completeness, or reliability of geotechnical exploration and other subsurface data by others that are included or referenced in these plates.
 11. These plans and stick-log plates are for the use and benefit of HDR, SBFCA, and their consultants in connection with the execution of the FRWL Project. Use by any other party is at their own discretion and risk. These figures should not be used as the sole basis for design, construction, remedial action, or major capital spending decisions.
 12. The canal/ditch elevations are approximate. These elevations were estimated from the topography.

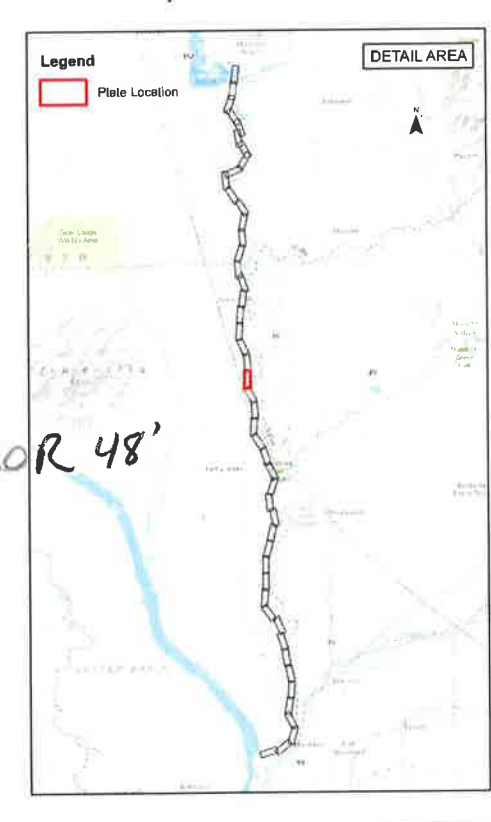
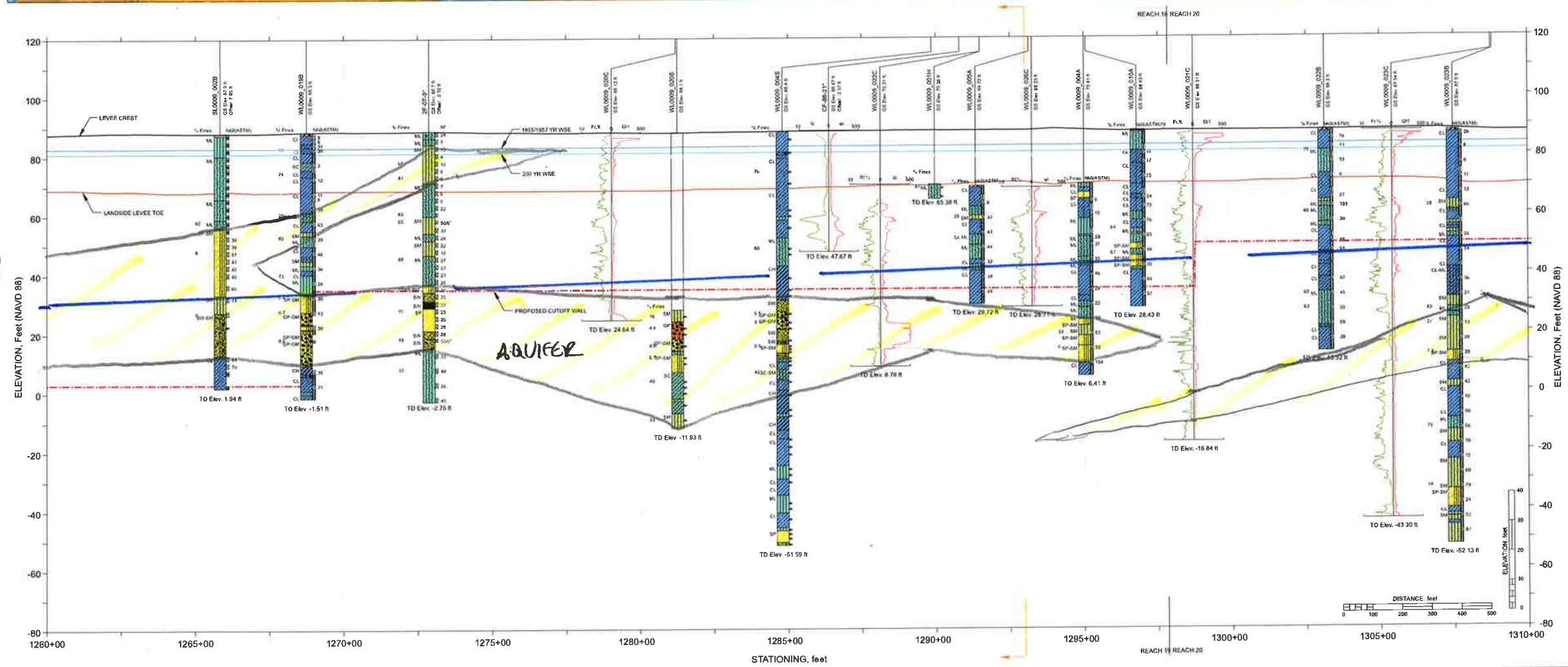

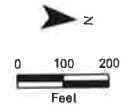
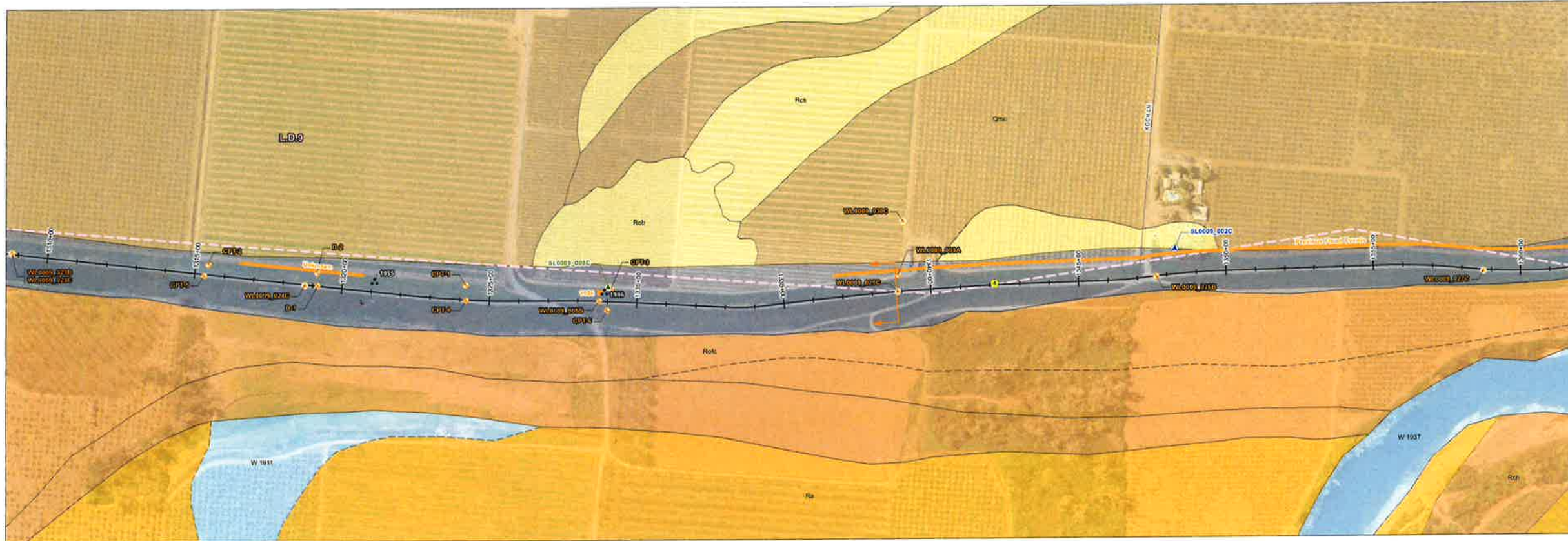

- NOTES:
- Elevations of levee crown and landside toe are approximate. These elevations were obtained from DWR CVFED or ULE LIDAR data and used for geotechnical analyses and report purpose only. For detail crown elevation and landside toe information, please refer to the FRWL Project civil drawings.
 - The water surface elevations are based on information provided by Peterson Brustad, Inc. in their July 26, 2012 report entitled "Design Water Surface Profiles for the Feather River West Levee Rehabilitation Project Addendum #1".
 - Locations of explorations are approximate. Stick logs represent general soil conditions encountered at the time of exploration. For more detailed information on the materials encountered, refer to boring and CPT logs in the Geotechnical Data Report for the FRWL Project. No warranty is provided regarding the continuity of soil conditions between individual explorations.
 - When reported, $N_{60}(ASTM)$ refers to $N_{60}(ASTM) = N_{60} \times \text{Hammer Efficiency} (\%)$. See Geotechnical Data Report for the FRWL Project for hammer efficiency data for individual borings.
 - These drawings do not include all historical explorations on the profile view. Historical explorations from the DWR ULE project are shown; "other" historical explorations are identified by an asterisk (*) in the exploration ID. For these "other" historical borings, blow counts are field blow counts (N) and USCS classifications are visual classifications.
 - USCS classification labels are not presented on the stick logs for soil lenses (thickness less than 1.5 feet).
 - This is a color figure. Black and white reproduction should not be relied upon as data will be lost.
 - To prevent scale distortion, this map should be printed on a "D" size sheet (22x34 inches).
 - Surficial geology was mapped at 1:20,000 scale. (Source: SGDR for DWR ULE Project, URS, 2010).
 - The information provided in these plans and stick-log piles has been compiled from a variety of sources. URS does not attest to the accuracy, completeness, or reliability of geotechnical exploration and other subsurface data by others that are included or referenced in these plans.
 - These plans and stick-log piles are for the use and benefit of HDR, SBFCA, and their consultants in connection with the execution of the FRWL Project. Use by any other party is at their own discretion and risk. These figures should not be used as the sole basis for design, construction, remedial action, or major capital spending decisions.
 - The canal/ditch elevations are approximate. These elevations were estimated from the topography.

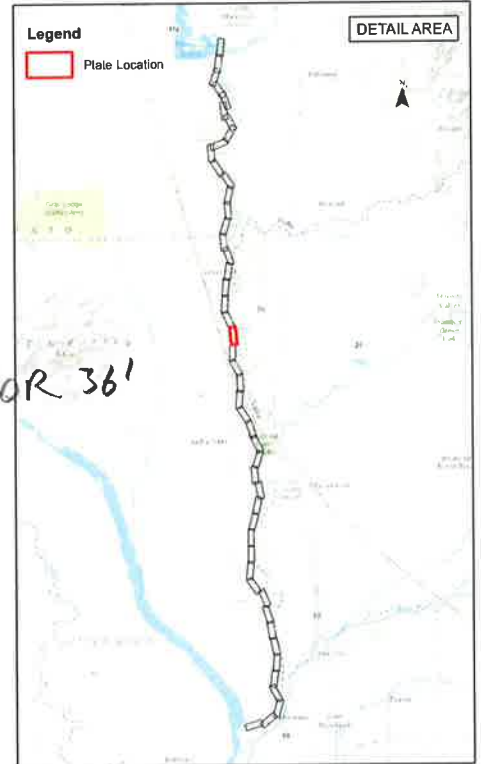
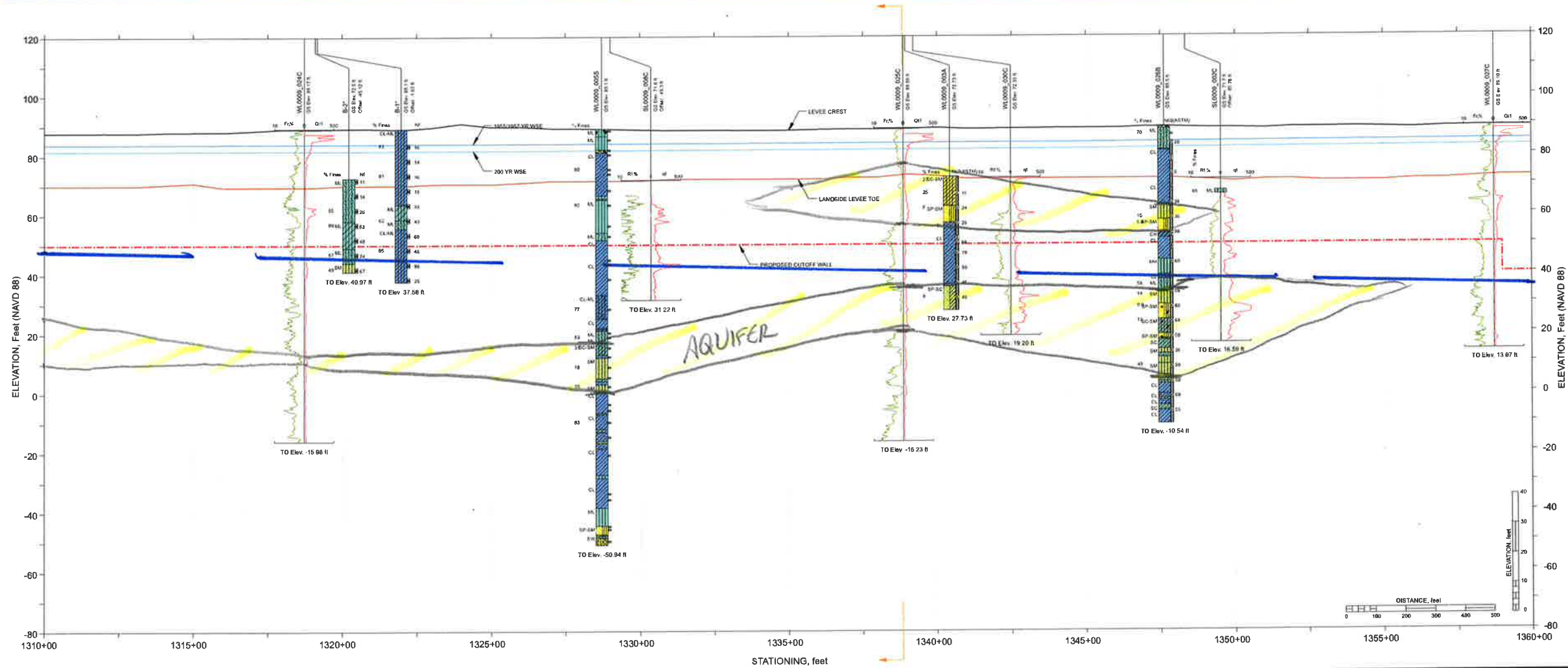

FRWL Project Plan Views and Stick Log Figures
FRWL Project: Station 1310+00 to Station 1360+00

NEW WALL CUTS OFF AQUIFER

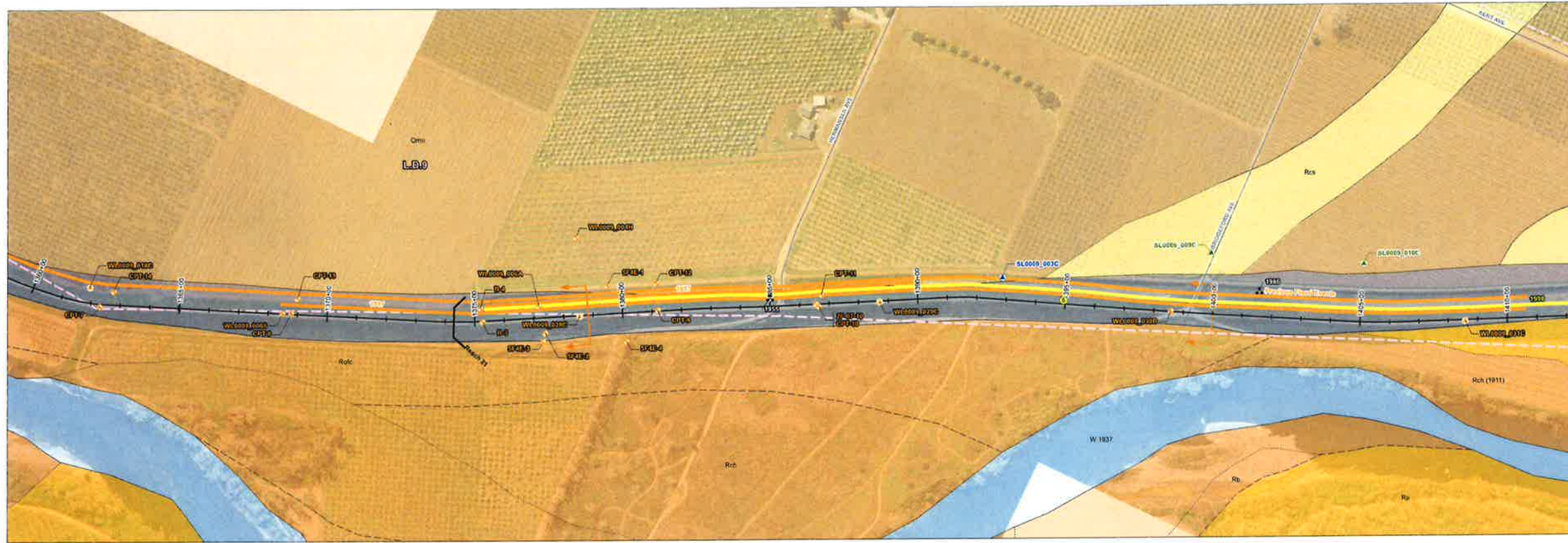

- 0 100 200 Feet
- NOTES:
- Elevations of levee crown and landside toe are approximate. These elevations were obtained from DWR CVFED or ULE LIDAR data and used for geotechnical analyses and report purpose only. For detail crown elevation and landside toe information, please refer to the FRWL Project civil drawings.
 - The water surface elevations are based on information provided by Peterson Brustad, Inc. in their July 26, 2012 report entitled "Design Water Surface Profiles for the Feather River West Levee Rehabilitation Project Addendum #1".
 - Locations of explorations are approximate. Stick logs represent general soil conditions encountered at the time of exploration. For more detailed information on the materials encountered, refer to boring and CPT logs in the Geotechnical Data Report for the FRWL Project. No warranty is provided regarding the continuity of soil conditions between individual explorations.
 - When reported, $N_{60}(ASTM)$, refers to $N_{60}(ASTM) = N_{60} \times \text{Hammer Efficiency } (\%)$. See Geotechnical Data Report for the FRWL Project for hammer efficiency data for individual borings.
 - These drawings do not include all historical explorations on the profile view. Historical explorations from the DWR ULE project are shown; "other" historical explorations are identified by an asterisk (*) in the exploration ID. For these "other" historical borings, blow counts are field blow counts (NF) and USCS classifications are visual classifications.
 - USCS classification labels are not presented on the stick logs for soil lenses (thickness less than 1.5 feet).
 - This is a color figure. Black and white reproduction should not be relied upon as data will be lost.
 - To prevent scale distortion, this map should be printed on a "D" size sheet (22x34 inches).
 - Surficial geology was mapped at 1:20,000 scale. (Source: SGRD for DWR ULE Project, URS,2010).
 - The information provided in these plans and stick-log plates has been compiled from a variety of sources. URS does not attest to the accuracy, completeness, or reliability of geotechnical exploration and other subsurface data by others that are included or referenced in these plates.
 - These plans and stick-log plates are for the use and benefit of HDR, SBFCA, and their consultants in connection with the execution of the FRWL Project. Use by any other party is at their own discretion and risk. These figures should not be used as the sole basis for design, construction, remedial action, or major capital spending decisions.
 - The canal/ditch elevations are approximate. These elevations were estimated from the topography.

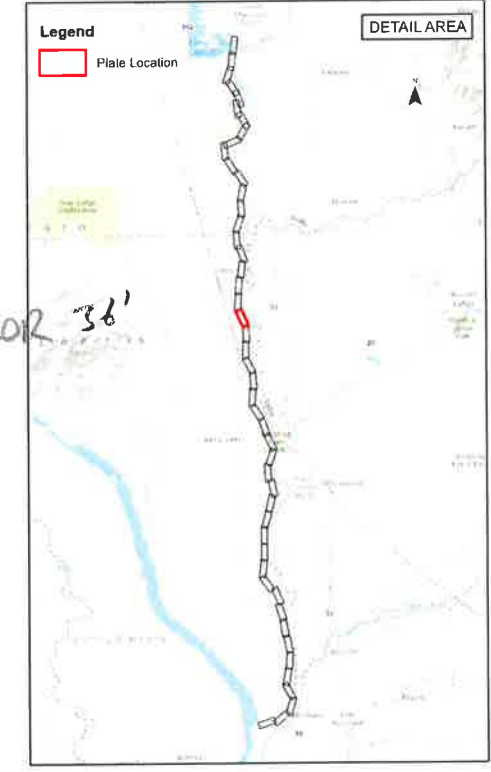
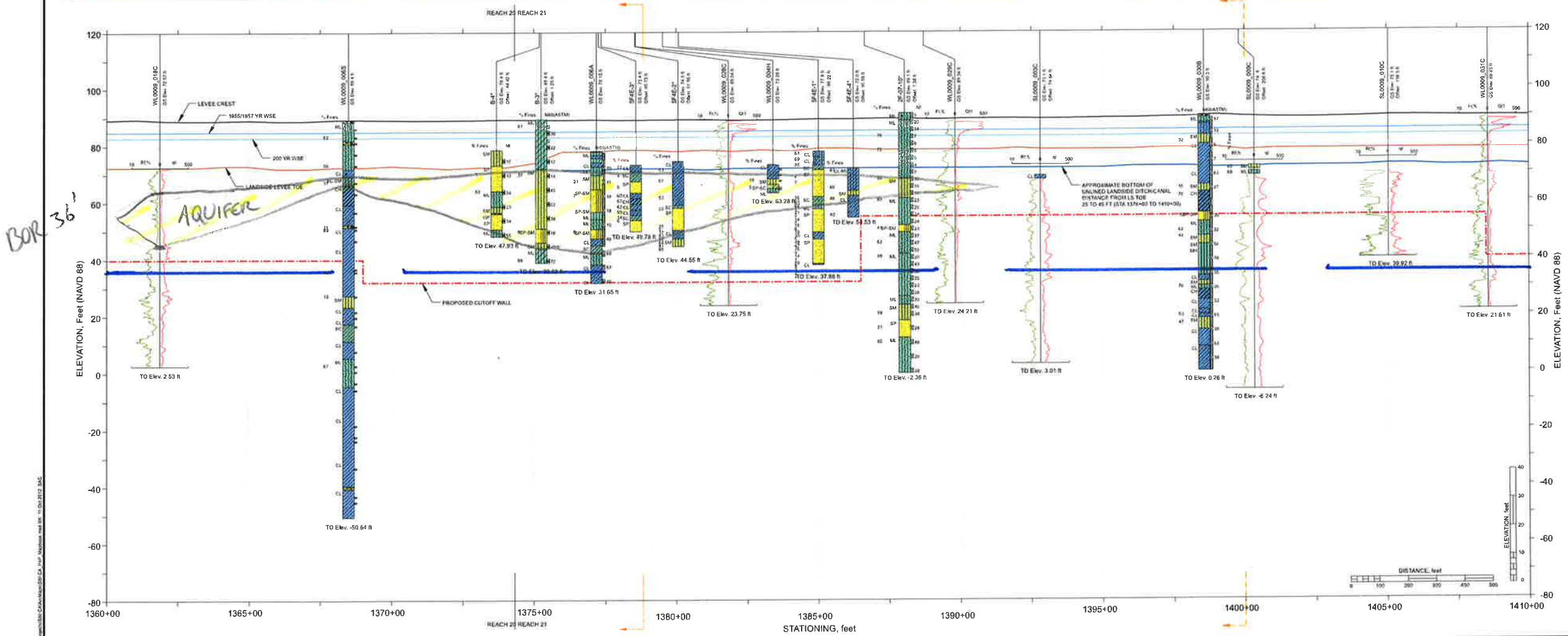

NEW WALL CUTS OFF UPPER AQUIFER

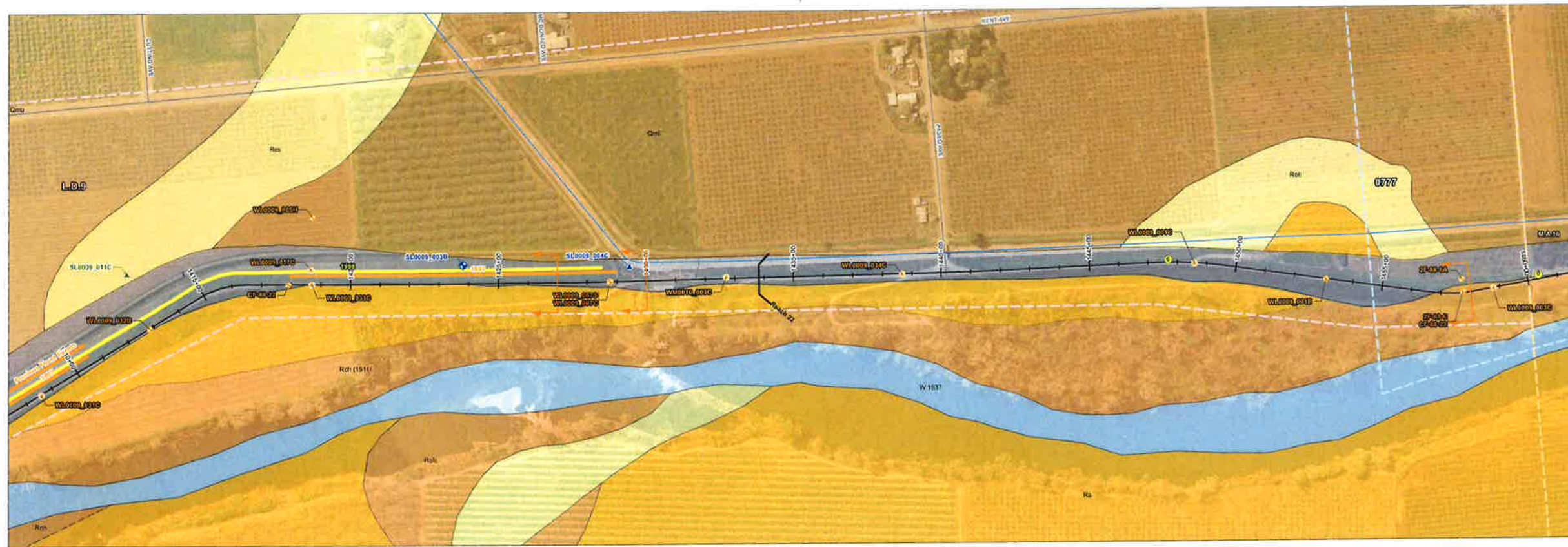

- NOTES:
- Elevations of levee crown and landside toe are approximate. These elevations were obtained from DWR CVFED or ULE LIDAR data and used for geotechnical analyses and report purpose only. For detail crown elevation and landside toe information, please refer to the FRWL Project civil drawings.
 - The water surface elevations are based on information provided by Peterson Brustad, Inc. in their July 26, 2012 report entitled "Design Water Surface Profiles for the Feather River West Levee Rehabilitation Project Addendum #1".
 - Locations of explorations are approximate. Slick logs represent general soil conditions encountered at the time of exploration. For more detailed information on the materials encountered, refer to boring and CPT logs in the Geotechnical Data Report for the FRWL Project. No warranty is provided regarding the continuity of soil conditions between individual explorations.
 - When reported, $N_{60}(ASTM)$ refers to $N_{60}(ASTM) = N_{60} \times \text{Hammer Efficiency } (\%)$. See Geotechnical Data Report for the FRWL Project for hammer efficiency data for individual borings.
 - These drawings do not include all historical explorations on the profile view. Historical explorations from the DWR ULE project are shown; "other" historical explorations are identified by an asterisk (*) in the exploration ID. For these "other" historical borings, blow counts are field blow counts (NI) and USCS classifications are visual classifications.
 - USCS classification labels are not presented on the slick logs for soil lenses (thickness less than 1.5 feet).
 - This is a color figure. Black or white reproduction should not be relied upon as data will be lost.
 - To prevent scale distortion, this map should be printed on a "D" size sheet (22x34 inches).
 - Surficial geology was mapped at 1:20,000 scale. (Source: SGRD for DWR ULE Project, URS, 2010).
 - The information provided in these plans and slick-log plates has been compiled from a variety of sources. URS does not attest to the accuracy, completeness, or reliability of geotechnical exploration and other subsurface data by others that are included or referenced in these plans.
 - These plans and slick-log plates are for the use and benefit of HDR, SBFCA, and their consultants in connection with the execution of the FRWL Project. Use by any other party is at their own discretion and risk. These figures should not be used as the sole basis for design, construction, remedial action, or major capital spending decisions.
 - The canal/itch elevations are approximate. These elevations were estimated from the topography.

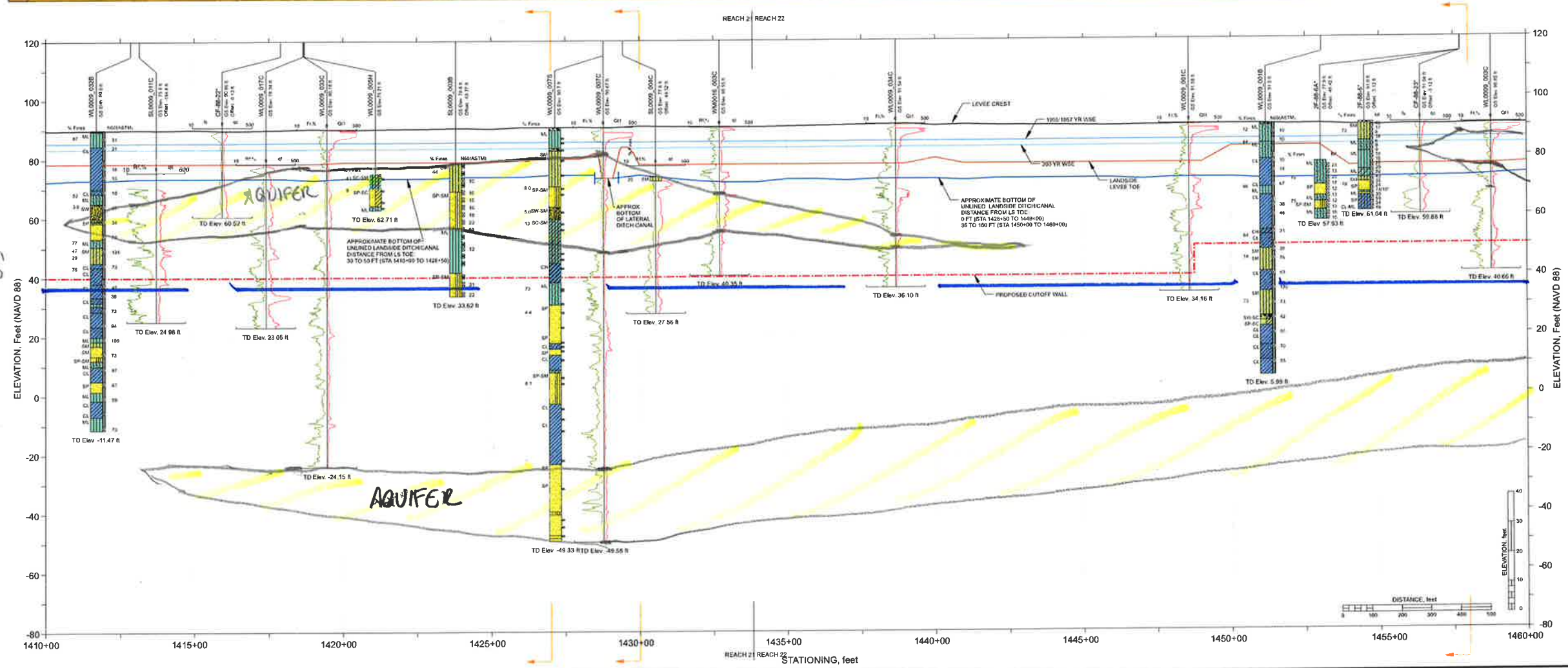

FRWL Project Plan Views and Stick Log Figures
FRWL Project: Station 1410+00 to Station 1460+00

NEW WALL CUTS OFF UPPER AQUIFER

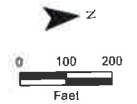

- NOTES:**
- Elevations of levee crown and landside toe are approximate. These elevations were obtained from DWR CVFED or ULE LIDAR data and used for geotechnical analyses and report purpose only. For detail crown elevation and landside toe information, please refer to the FRWL Project civil drawings.
 - The water surface elevations are based on information provided by Peterson Brustad, Inc. in their July 26, 2012 report entitled "Design Water Surface Profiles for the Feather River West Levee Rehabilitation Project Addendum #1".
 - Locations of explorations are approximate. Stick logs represent general soil conditions encountered at the time of exploration. For more detailed information on the materials encountered, refer to boring and CPT logs in the Geotechnical Data Report for the FRWL Project. No warranty is provided regarding the continuity of soil conditions between individual explorations.
 - When reported, $N_{60}(ASTM)$ refers to $N_{60}(ASTM) = N_{60} \times \text{Hammer Efficiency } (\%)$. See Geotechnical Data Report for the FRWL Project for hammer efficiency data for individual borings.
 - These drawings do not include all historical explorations on the profile view. Historical explorations from the DWR ULE project are shown; "other" historical explorations are identified by an asterisk (*) in the exploration ID. For these "other" historical borings, blow counts are field blow counts (N) and USCS classifications are visual classifications.
 - USCS classification labels are not presented on the stick logs for soil lenses (thickness less than 1.5 feet).
 - This is a color figure. Black and white reproduction should not be relied upon as data will be lost.
 - To prevent scale distortion, this map should be printed on a "D" size sheet (22x34 inches).
 - Soil geology was mapped at 1:20,000 scale. (Source: SGRD for DWR ULE Project, URS, 2010).
 - The information provided in these plans and stick-log plates has been compiled from a variety of sources. URS does not attest to the accuracy, completeness, or reliability of geotechnical exploration and other subsurface data by others that are included or referenced in these plates.
 - These plans and stick-log plates are for the use and benefit of HDR, SBFCA, and their consultants in connection with the execution of the FRWL Project. Use by any other party is at their own discretion and risk. These figures should not be used as the sole basis for design, construction, remedial action, or major capital spending decisions.
 - The canal/ditch elevations are approximate. These elevations were estimated from the topography.

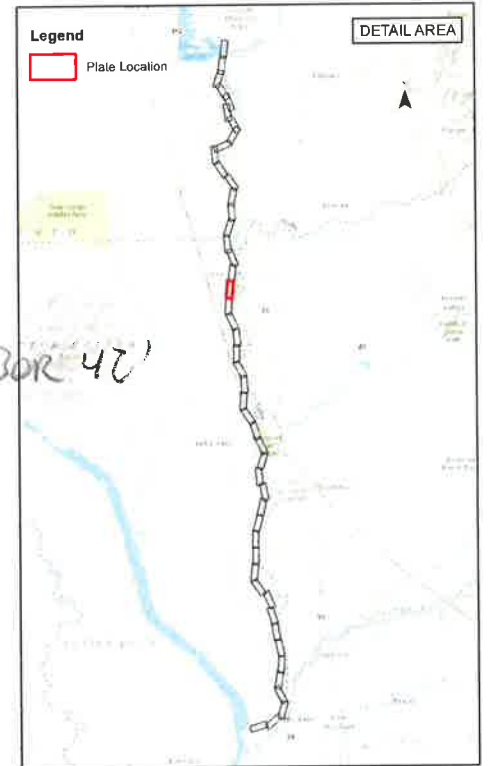
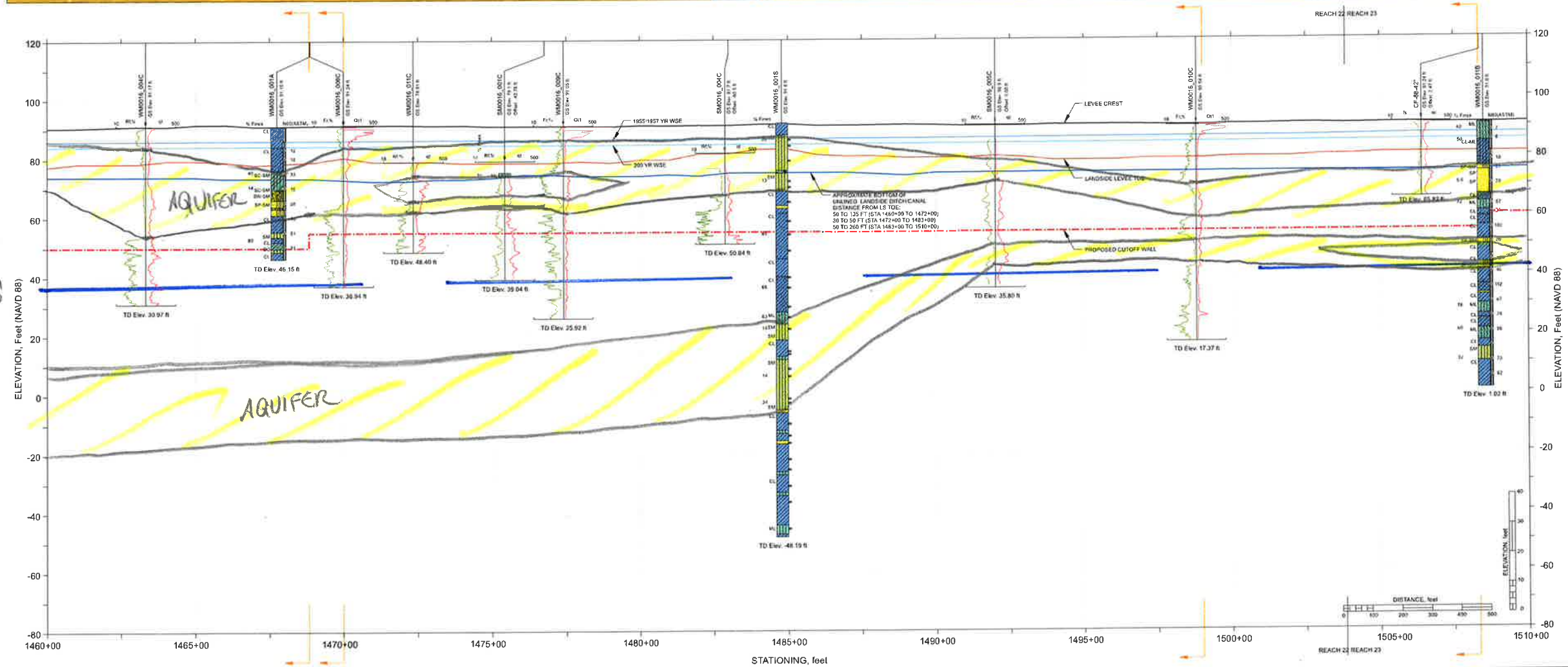

FRWL Project Plan Views and Stick Log Figures
FRWL Project: Station 1460+00 to Station 1510+00

URS Geotechnical Design
Recommendations Report

Sutter Butte Flood Control Agency
FEATHER RIVER WEST LEVEE PROJECT

Appendix
A32

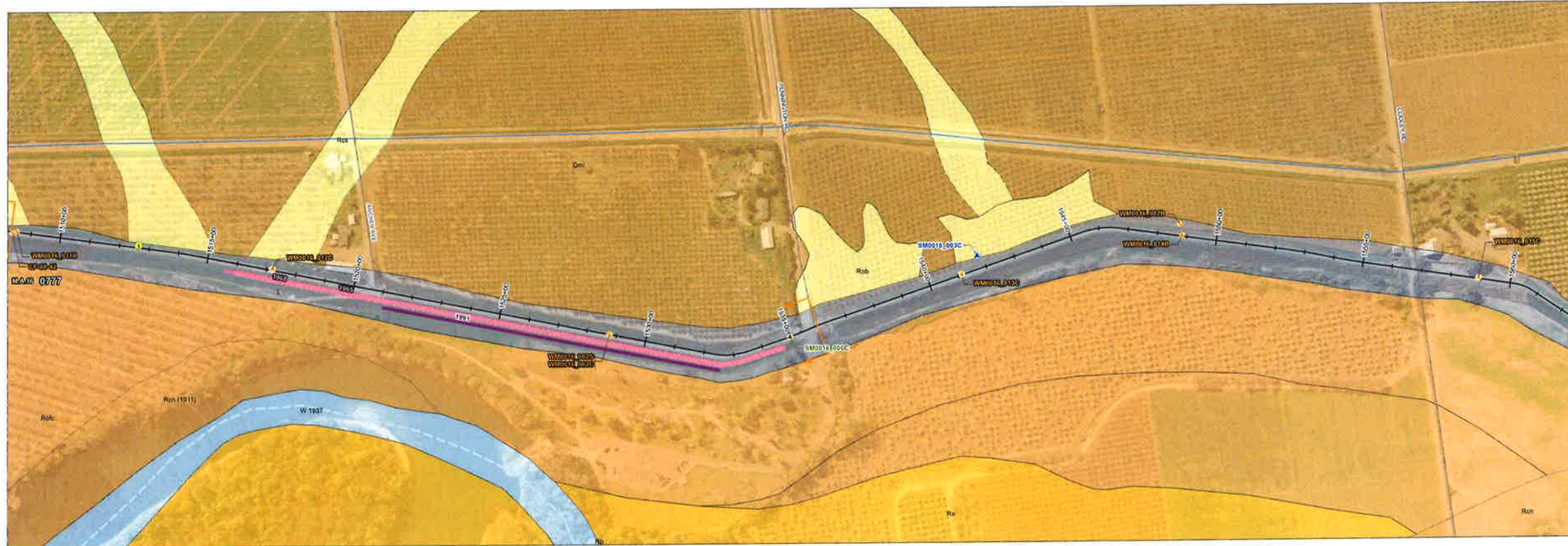

- NOTES:
- Elevations of levee crown and landside toe are approximate. These elevations were obtained from DWR CVFED or ULE LIDAR data and used for geotechnical analyses and report purpose only. For detail crown elevation and landside toe information, please refer to the FRWL Project civil drawings.
 - The water surface elevations are based on information provided by Peterson Brustad, Inc. in their July 26, 2012 report entitled "Design Water Surface Profiles for the Feather River West Levee Rehabilitation Project Addendum #1".
 - Locations of explorations are approximate. Stick logs represent general soil conditions encountered at the time of exploration. For more detailed information on the materials encountered, refer to boring and CPT logs in the Geotechnical Data Report for the FRWL Project. No warranty is provided regarding the continuity of soil conditions between individual explorations.
 - When reported, N_{60} (ASTM) refers to N_{60} (ASTM) = N_{60} * Hammer Efficiency (%). See Geotechnical Data Report for the FRWL Project for hammer efficiency data for individual borings.
 - These drawings do not include all historical explorations on the profile view. Historical explorations from the DWR ULE project are shown; "other" historical explorations are identified by an asterisk (*) in the exploration ID. For these "other" historical borings, blow counts are field blow counts (NF) and USCS classifications are visual classifications.
 - USCS classification labels are not presented on the stick logs for soil lenses (thickness less than 1.5 feet).
 - This is a color figure. Black and white reproduction should not be relied upon as data will be lost.
 - To prevent scale distortion, this map should be printed on a "D" size sheet (22x34 inches).
 - Surficial geology was mapped at 1:20,000 scale. (Source: SGDR for DWR ULE Project, URS, 2010).
 - The information provided in these plans and stick-log plates has been compiled from a variety of sources. URS does not attest to the accuracy, completeness, or reliability of geotechnical exploration and other subsurface data by others that are included or referenced in these plates.
 - These plans and stick-log plates are for the use and benefit of HDR, SBFCA, and their consultants in connection with the execution of the FRWL Project. Use by any other party is at their own discretion and risk. These figures should not be used as the sole basis for design, construction, remedial action, or major capital spending decisions.
 - The consultant elevations are approximate. These elevations were estimated from the topography.

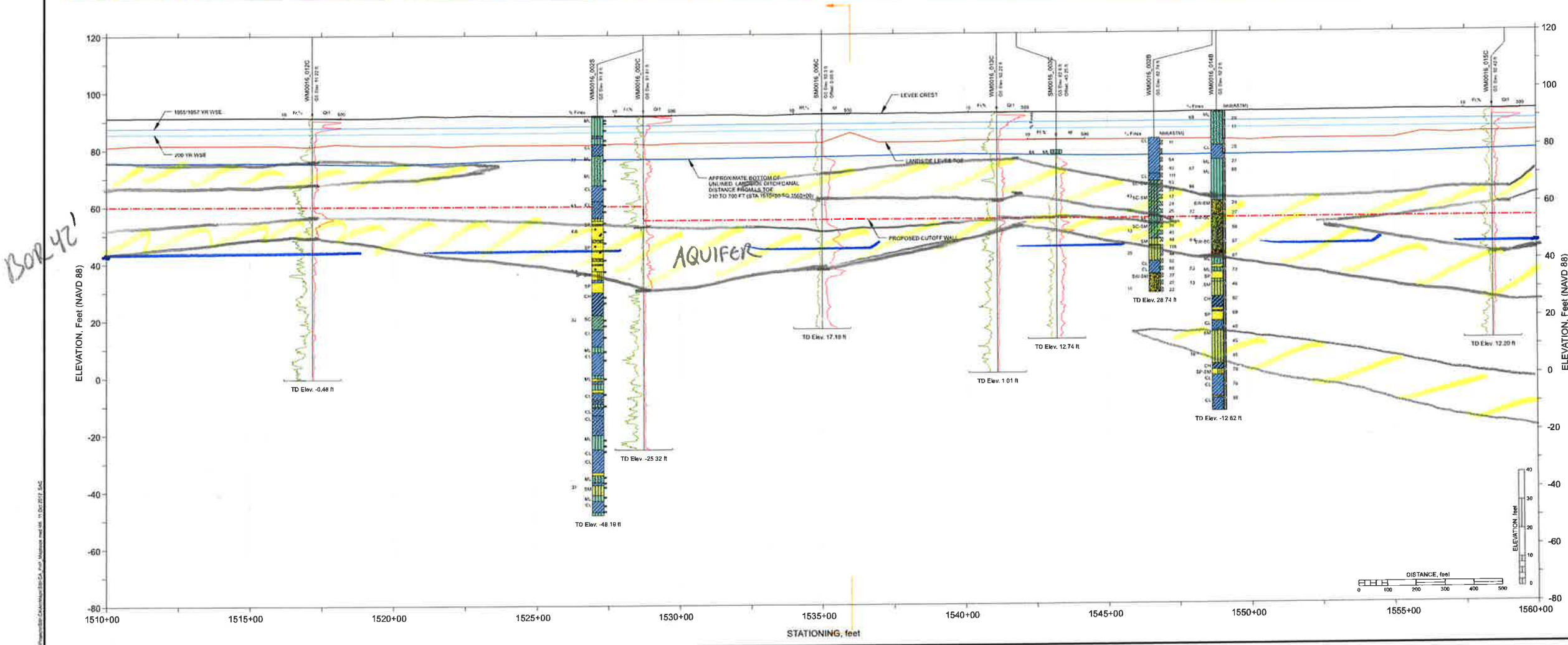

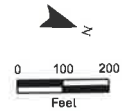
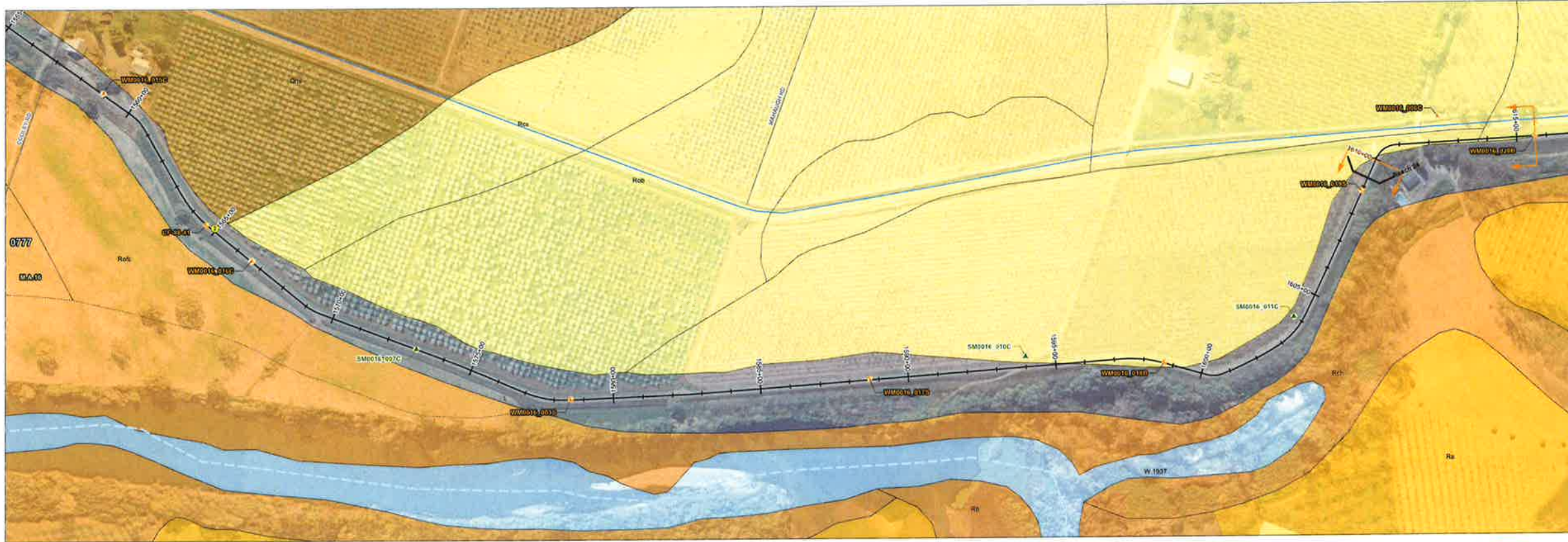

- NOTES:
1. Elevations of levee crown and landside toe are approximate. These elevations were obtained from DWR CVFED or ULE LIDAR data and used for geotechnical analyses and report purpose only. For detail crown elevation and landside toe information, please refer to the FRWL Project civil drawings.
 2. The water surface elevations are based on information provided by Peterson Brusilad, Inc. in their July 26, 2012 report entitled "Design Water Surface Profiles for the Feather River West Levee Rehabilitation Project Addendum #1".
 3. Locations of explorations are approximate. Stick logs represent general soil conditions encountered at the time of exploration. For more detailed information on the materials encountered, refer to boring and CPT logs in the Geotechnical Data Report for the FRWL Project. No warranty is provided regarding the continuity of soil conditions between individual explorations.
 4. When reported, N_{60} (ASTM), refers to N_{60} (ASTM) = N_{60} * Hammer Efficiency (%). See Geotechnical Data Report for the FRWL Project for hammer efficiency data for individual borings.
 5. These drawings do not include all historical explorations on the profile view. Historical explorations from the DWR ULE project are shown; "other" historical explorations are identified by an asterisk (*) in the exploration ID. For these "other" historical borings, blow counts are field blow counts (N) and USCS classifications are visual classifications.
 6. USCS classification labels are not presented on the stick logs for soil lenses (thickness less than 1.5 feet).
 7. This is a color figure. Black and white reproduction should not be relied upon as data will be lost.
 8. To prevent scale distortion, this map should be printed on a "D" size sheet (22x34 inches).
 9. Surficial geology was mapped at 1:20,000 scale. (Source: SGDR for DWR ULE Project, URS, 2010).
 10. The information provided in these plans and stick-log plates has been compiled from a variety of sources. URS does not attest to the accuracy, completeness, or reliability of geotechnical exploration and other subsurface data by others that are included or referenced in these plates.
 11. These plans and stick-log plates are for the use and benefit of HDR, SBFCA, and their consultants in connection with the execution of the FRWL Project. Use by any other party is at their own discretion and risk. These figures should not be used as the sole basis for design, construction, remedial action, or major capital spending decisions.
 12. The canal/ditch elevations are approximate. These elevations were estimated from the topography.

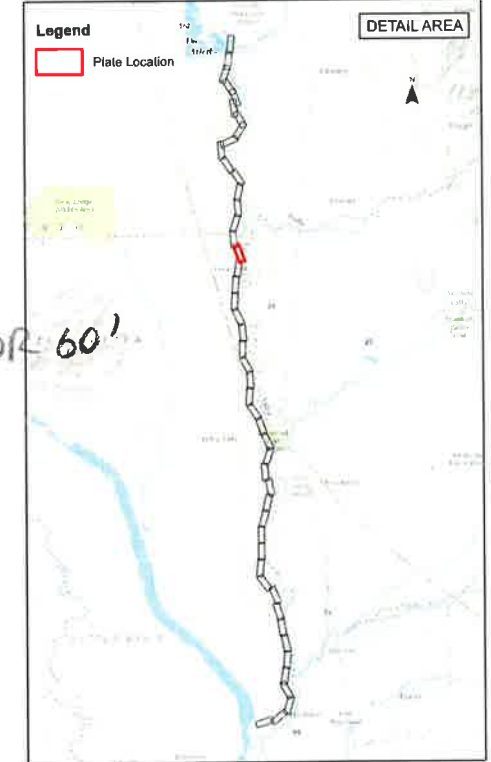
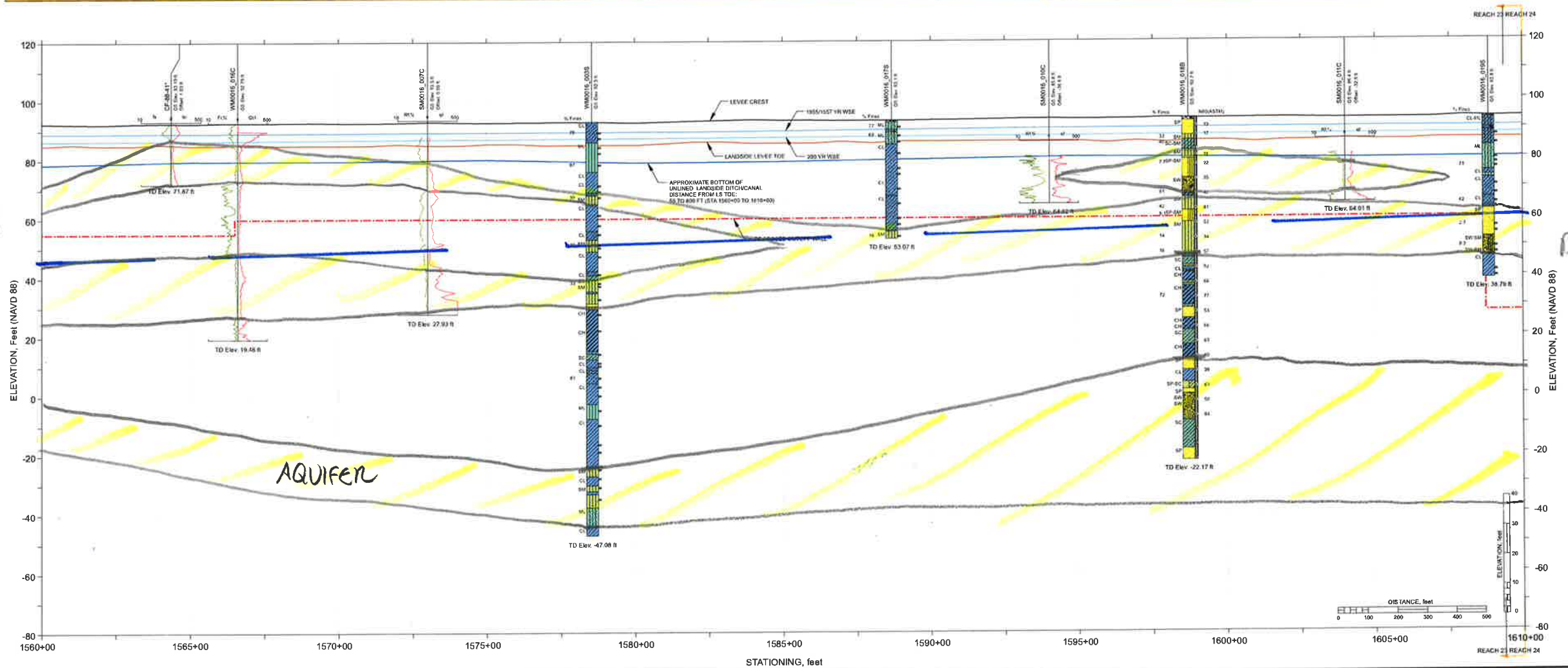

FRWL Project Plan Views and Stick Log Figures
FRWL Project: Station 1560+00 to Station 1610+00

NEW WALL CUTS OFF SMALL PORTION OF UPPER AQUIFER



- 0 100 200 Feet
- NOTES:
- Elevations of levee crown and landside toe are approximate. These elevations were obtained from DWR CVFED or ULE LIDAR data and used for geotechnical analyses and report purpose only. For detail crown elevation and landside toe information, please refer to the FRWL Project civil drawings.
 - The water surface elevations are based on information provided by Peterson Brustad, Inc. in their July 26, 2012 report entitled "Design Water Surface Profiles for the Feather River West Levee Rehabilitation Project Addendum #1".
 - Locations of explorations are approximate. Stick logs represent general soil conditions encountered at the time of exploration. For more detailed information on the materials encountered, refer to boring and CPT logs in the Geotechnical Data Report for the FRWL Project. No warranty is provided regarding the continuity of soil conditions between individual explorations.
 - When reported, N_{60} (ASTM) refers to N_{60} (ASTM) = N_{60} * Hammer Efficiency (%). See Geotechnical Data Report for the FRWL Project for hammer efficiency data for individual borings.
 - These drawings do not include all historical explorations on the profile view. Historical explorations from the DWR ULE project are shown; "other" historical explorations are identified by an asterisk (*) in the exploration ID. For these "other" historical borings, blow counts are field blow counts (NF) and USCS classifications are visual classifications.
 - USCS classification labels are not presented on the stick logs for soil lenses (thickness less than 1.5 feet).
 - This is a color figure. Black and white reproduction should not be relied upon as data will be lost.
 - To prevent scale distortion, this map should be printed on a 'D' size sheet (22x34 inches).
 - Surficial geology was mapped at 1:20,000 scale. (Source: SGR for DWR ULE Project, URS, 2010).
 - The information provided in these plans and stick-log plates has been compiled from a variety of sources. URS does not attest to the accuracy, completeness, or reliability of geotechnical exploration and other subsurface data by others that are included or referenced in these plates.
 - These plans and stick-log plates are for the use and benefit of HDR, SBFCA, and their consultants in connection with the execution of the FRWL Project. Use by any other party is at their own discretion and risk. These figures should not be used as the sole basis for design, construction, remedial action, or major capital spending decisions.
 - The canal/ditch elevations are approximate. These elevations were estimated from the topography.

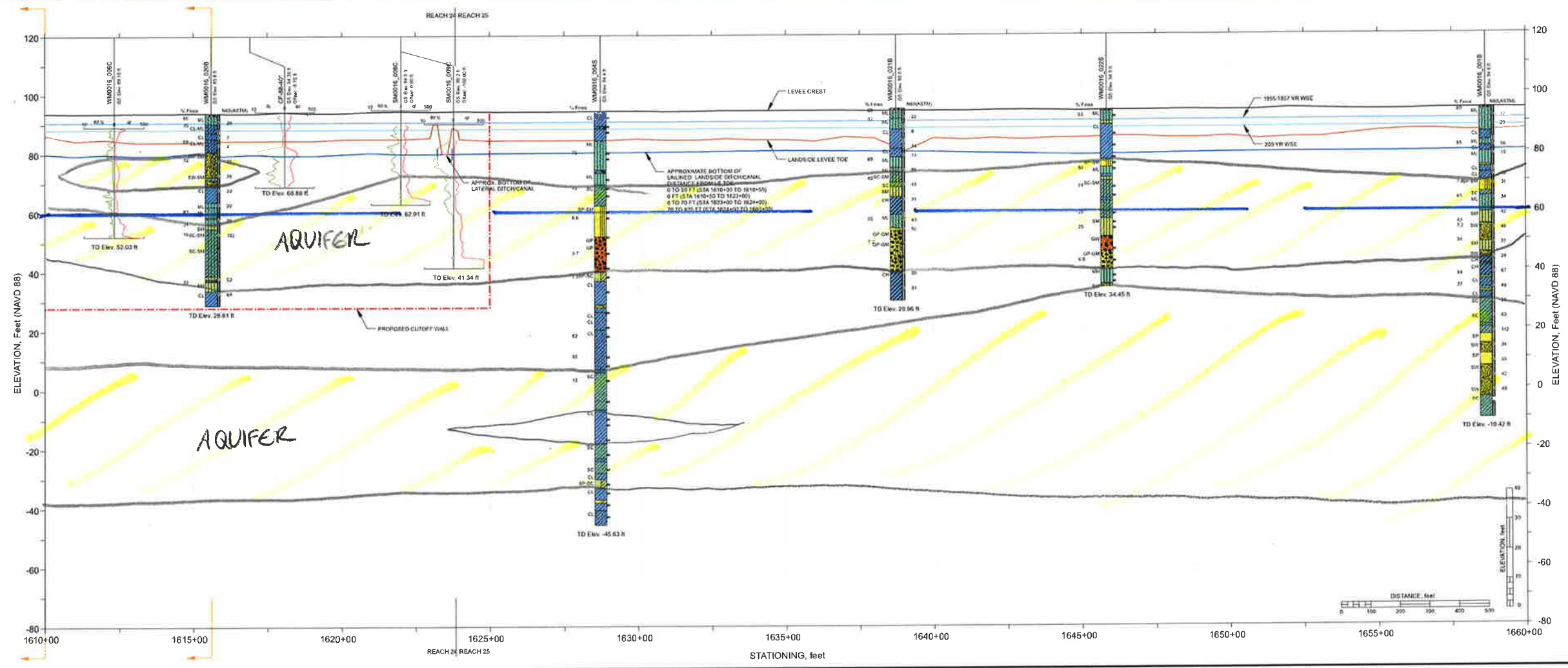

NEW WALL CUTS OFF SHALLOW AQUIFER FROM ~ SDA, 1695+00 TO 1727+50

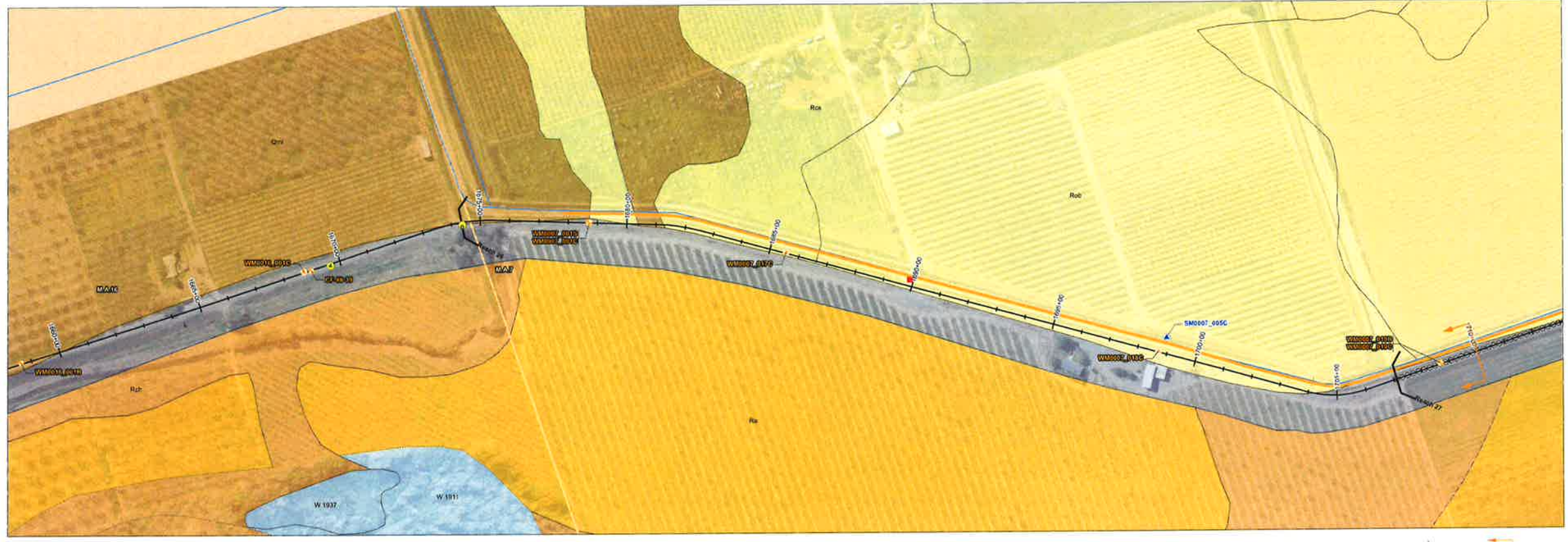

- NOTES:
- Elevations of levee crown and landside toe are approximate. These elevations were obtained from DWR CVFED or ULE LIDAR data and used for geotechnical analyses and report purposes only. For detail crown elevation and landside toe information, please refer to the FRWL Project civil drawings.
 - The water surface elevations are based on information provided by Peterson Brusted, Inc. in their July 26, 2012 report entitled "Design Water Surface Profiles for the Feather River West Levee Rehabilitation Project Addendum #1".
 - Locations of explorations are approximate. Stick logs represent general soil conditions encountered at the time of exploration. For more detailed information on the materials encountered, refer to boring and CPT logs in the Geotechnical Data Report for the FRWL Project. No warranty is provided regarding the continuity of soil conditions between individual explorations.
 - When reported, $N_{60}(ASTM)$ refers to $N_{60}(ASTM) = N_{60} * \text{Hammer Efficiency} (\%)$. See Geotechnical Data Report for the FRWL Project for hammer efficiency data for individual borings.
 - These drawings do not include all historical explorations on the profile view. Historical explorations from the DWR ULE project are shown; "other" historical explorations are identified by an asterisk (*) in the exploration ID. For these "other" historical borings, blow counts are field blow counts (NF) and USCS classifications are visual classifications.
 - USCS classification labels are not presented on the stick logs for soil lenses (thickness less than 1.5 feet).
 - This is a color figure. Black and white reproduction should not be relied upon as data will be lost.
 - To prevent scale distortion, this map should be printed on a "D" size sheet (22x34 inches).
 - Surficial geology was mapped at 1:20,000 scale. (Source: SDDR for DWR ULE Project, URS, 2010).
 - The information provided in these plans and stick-log plates has been compiled from a variety of sources. URS does not attest to the accuracy, completeness, or reliability of geotechnical exploration and other subsurface data by others that are included or referenced in these plates.
 - These plans and stick-log plates are for the use and benefit of HDR, SBFCA, and their consultants in connection with the execution of the FRWL Project. Use by any other party is at their own discretion and risk. These figures should not be used as the sole basis for design, construction, remedial action, or major capital spending decisions.
 - The canal/ditch elevations are approximate. These elevations were estimated from the topography.

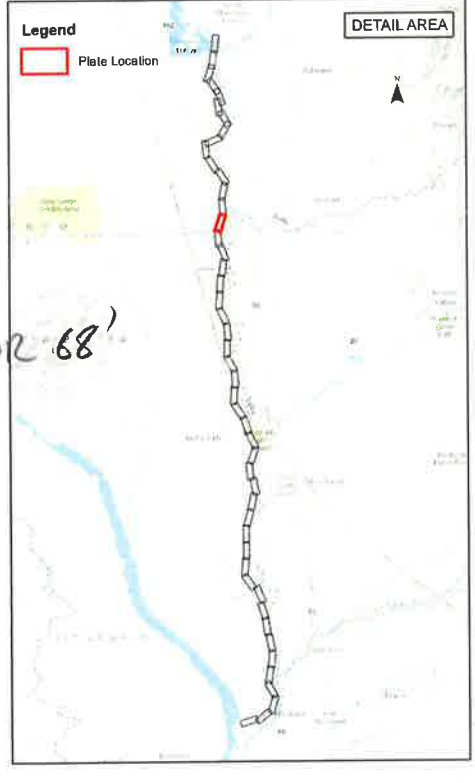
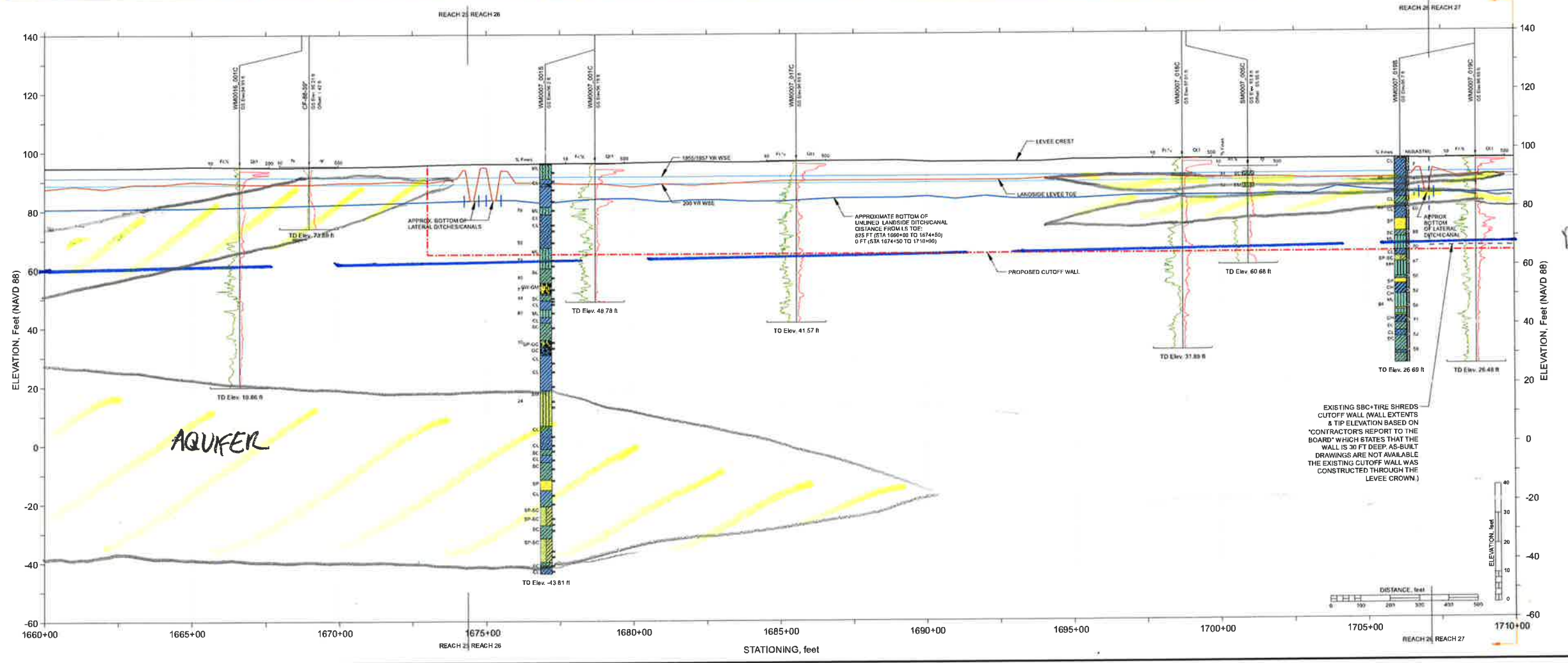

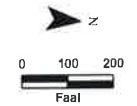
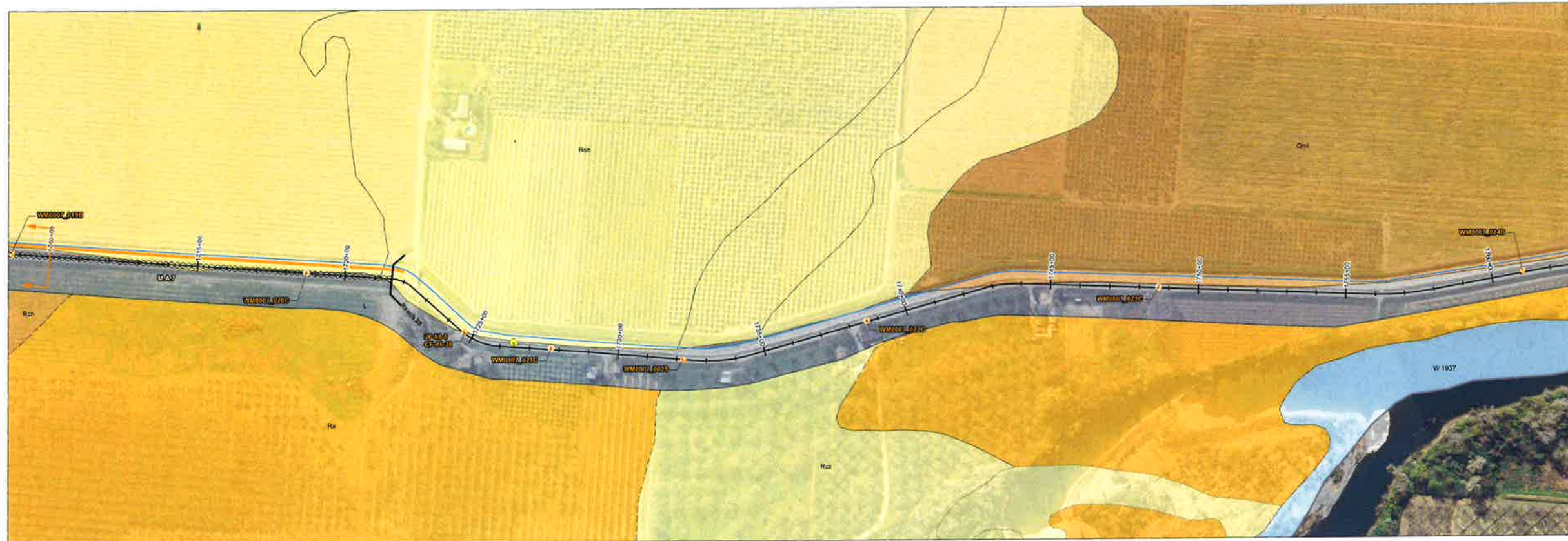

- NOTES:
- Elevations of levee crown and landside loa are approximate. These elevations were obtained from DWR CVFED or ULE LIDAR data and used for geotechnical analyses and report purpose only. For detail crown elevation and landside loa information, please refer to the FRWL Project civil drawings.
 - The water surface elevations are based on information provided by Peterson Brustad, Inc. in their July 26, 2012 report entitled "Design Water Surface Profiles for the Feather River West Levee Rehabilitation Project Addendum #1".
 - Locations of explorations are approximate. Slick logs represent general soil conditions encountered at the time of exploration. For more detailed information on the materials encountered, refer to boring and CPT logs in the Geotechnical Data Report for the FRWL Project. No warranty is provided regarding the continuity of soil conditions between individual explorations.
 - When reported, N_{60} (ASTM) refers to N_{60} (ASTM) = N_{60} * Hammer Efficiency (%). See Geotechnical Data Report for the FRWL Project for hammer efficiency data for individual borings.
 - These drawings do not include all historical explorations on the profile view. Historical explorations from the DWR ULE project are shown; "other" historical explorations are identified by an asterisk (*) in the exploration ID. For these "other" historical borings, blow counts are field blow counts (NF) and USCS classifications are visual classifications.
 - USCS classification labels are not presented on the slick logs for soil lenses (thickness less than 1.5 feet).
 - This is a color figure. Black and white reproduction should not be relied upon as data will be lost.
 - To prevent scale distortion, this map should be printed on a 'D' size sheet (22x34 inches).
 - Surficial geology was mapped at 1:20,000 scale. (Source: SGRD for DWR ULE Project, URS,2010).
 - The information provided in these plans and slick-log plates has been compiled from a variety of sources. URS does not attest to the accuracy, completeness, or reliability of geotechnical exploration and other subsurface data by others that are included or referenced in these plates.
 - These plans and slick-log plates are for the use and benefit of HDR, SBFCA, and their consultants in connection with the execution of the FRWL Project. Use by any other party is at their own discretion and risk. These figures should not be used as the sole basis for design, construction, remedial action, or major capital spending decisions.
 - The canal/ditch elevations are approximate. These elevations were estimated from the topography.

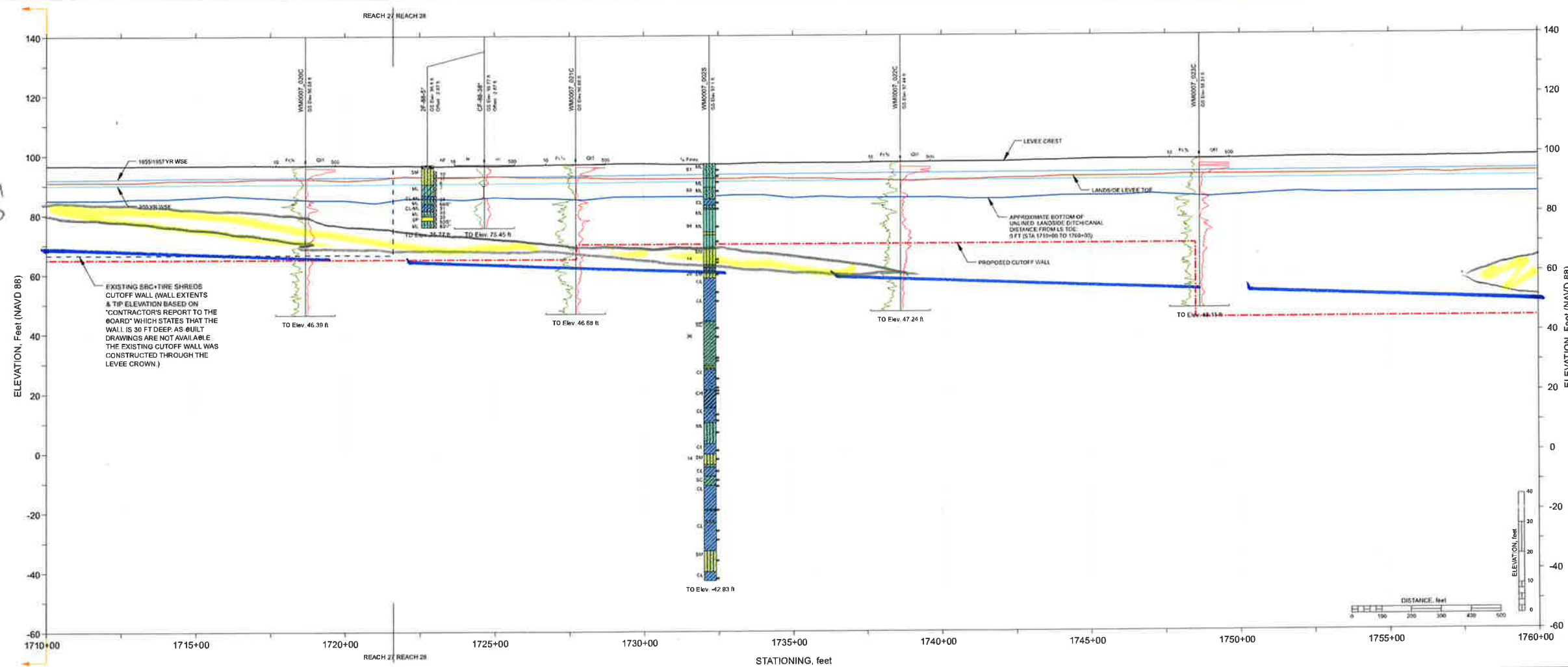

BOR 68'

BOR 50'



FRWL Project Plan Views and Stick Log Figures
FRWL Project: Station 1710+00 to Station 1760+00

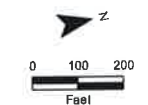
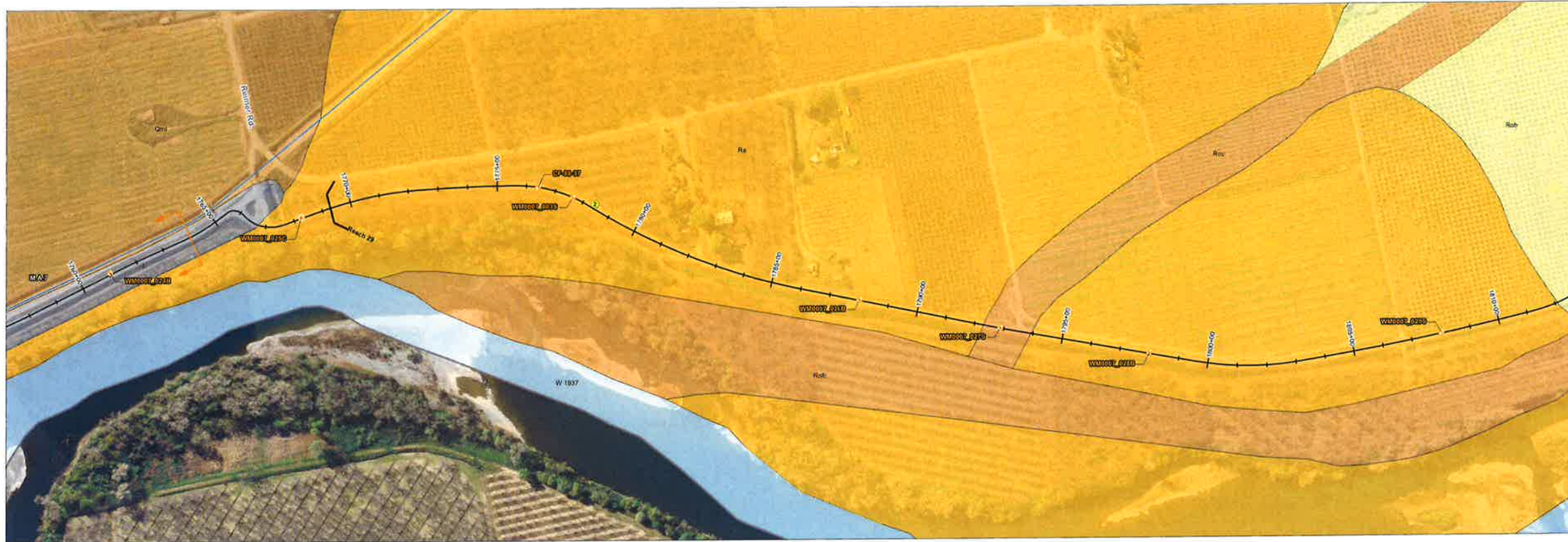

- NOTES:
- Elevations of levee crown and landside toe are approximate. These elevations were obtained from DWR CVFED or ULE LIDAR data and used for geotechnical analysis and report purpose only. For detail crown elevation and landside toe information, please refer to the FRWL Project civil drawings.
 - The water surface elevations are based on information provided by Peterson Brustad, Inc. in their July 26, 2012 report entitled "Design Water Surface Profiles for the Feather River West Levee Rehabilitation Project Addendum #1".
 - Locations of explorations are approximate. Stick logs represent general soil conditions encountered at the time of exploration. For more detailed information on the materials encountered, refer to boring and CPT logs in the Geotechnical Data Report for the FRWL Project. No warranty is provided regarding the continuity of soil conditions between individual explorations.
 - When reported, N_{60} (ASTM) refers to N_{60} (ASTM) = N_{60} * Hammer Efficiency (%). See Geotechnical Data Report for the FRWL Project for hammer efficiency data for individual borings.
 - These drawings do not include all historical explorations on the profile view. Historical explorations from the DWR ULE project are shown; "other" historical explorations are identified by an asterisk (*) in the exploration ID. For these "other" historical borings, blow counts are field blow counts (NF) and USCS classifications are visual classifications.
 - USCS classification labels are not presented on the stick logs for soil lenses (thickness less than 1.5 feet).
 - This is a color figure. Black and white reproduction should not be relied upon as data will be lost.
 - To prevent scale distortion, this map should be printed on a "D" size sheet (22x34 inches).
 - Surficial geology was mapped at 1:20,000 scale. (Source: SGDR for DWR ULE Project, URS, 2010).
 - The information provided in these plans and stick-log plates has been compiled from a variety of sources. URS does not attest to the accuracy, completeness, or reliability of geotechnical exploration and other subsurface data by others that are included or referenced in these plans.
 - These plans and stick-log plates are for the use and benefit of HDR, SBFCA, and their consultants in connection with the execution of the FRWL Project. Use by any other party is at their own discretion and risk. These figures should not be used as the sole basis for design, construction, remedial action, or major capital spending decisions.
 - The canal/ditch elevations are approximate. These elevations were estimated from the topography.

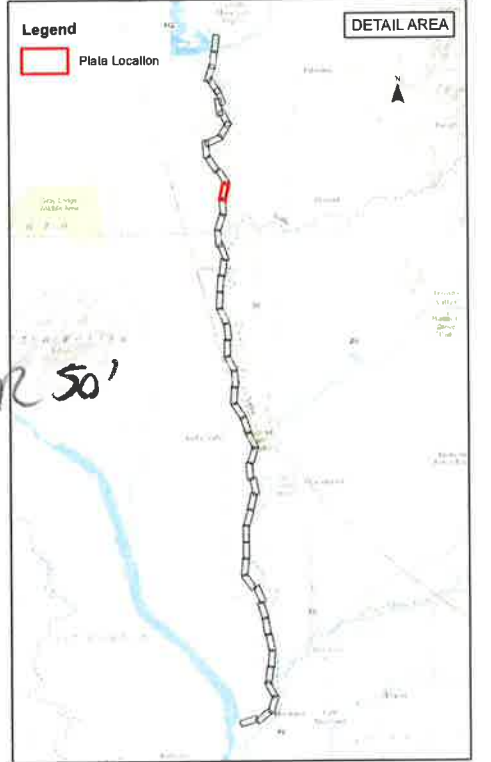
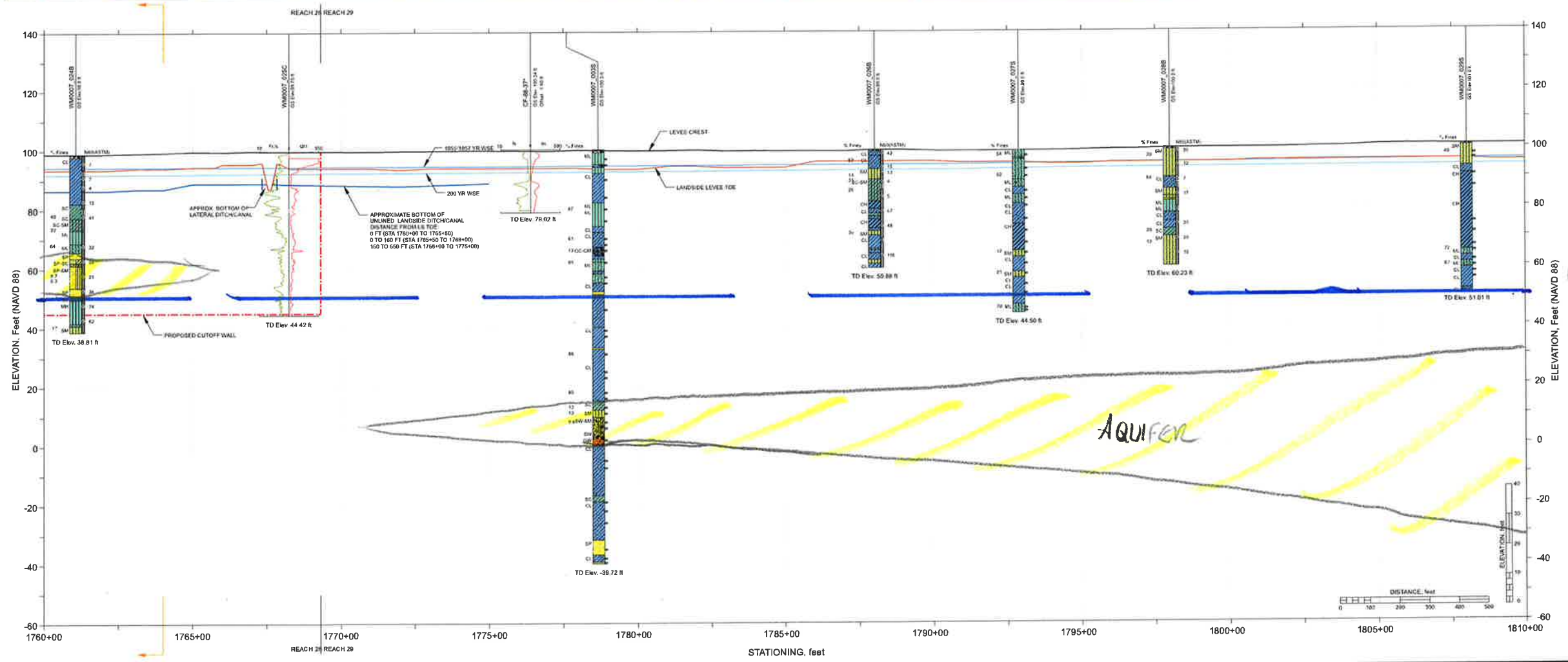

FRWL Project Plan Views and Stick Log Figures
FRWL Project: Station 1760+00 to Station 1810+00

NEW WALL CUTS OFF SHALLOW AQUIFER

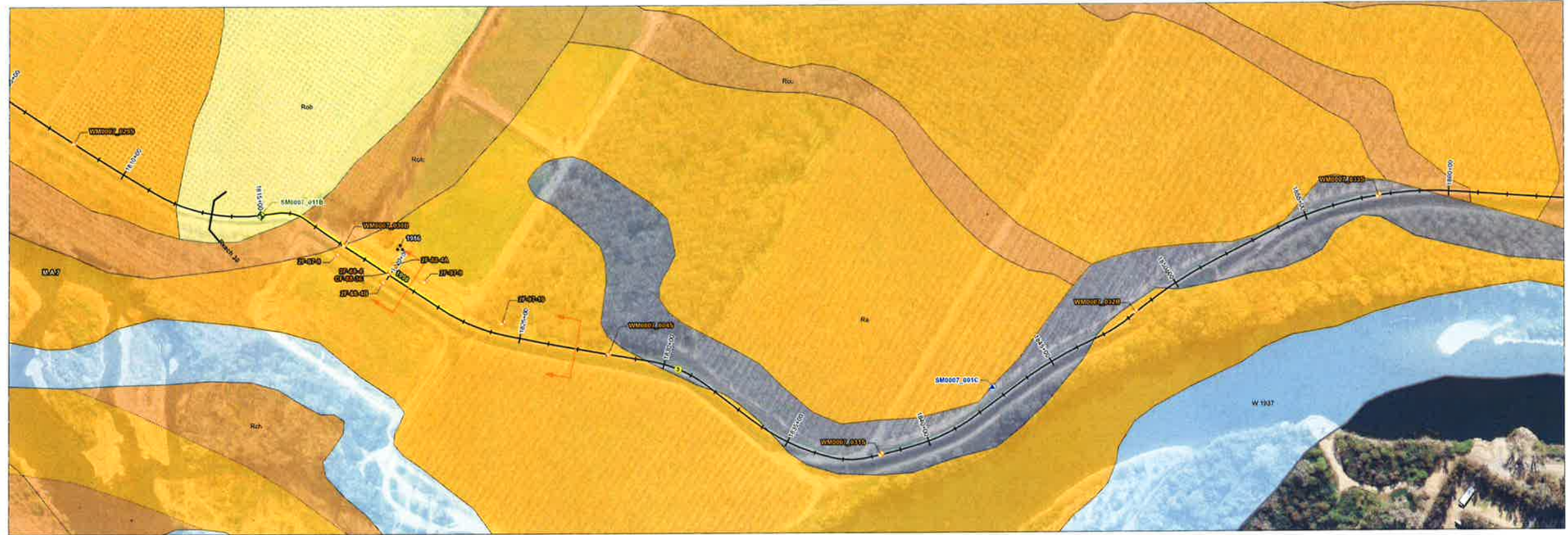

- 0 100 200 Feet
- NOTES:
- Elevations of levee crown and landside toe are approximate. These elevations were obtained from DWR CVFED or ULE LIDAR data and used for geotechnical analyses and report purpose only. For detail crown elevation and landside toe information, please refer to the FRWL Project civil drawings.
 - The water surface elevations are based on information provided by Peterson Brustad, Inc. in their July 26, 2012 report entitled "Design Water Surface Profiles for the Feather River West Levee Rehabilitation Project Addendum #1".
 - Locations of explorations are approximate. Stick logs represent general soil conditions encountered at the time of exploration. For more detailed information on the materials encountered, refer to boring and CPT logs in the Geotechnical Data Report for the FRWL Project. No warranty is provided regarding the continuity of soil conditions between individual explorations.
 - When reported, N_{60} (ASTM) refers to N_{60} (ASTM) = N_{60} * Hammer Efficiency (%). See Geotechnical Data Report for the FRWL Project for hammer efficiency data for individual borings.
 - These drawings do not include all historical explorations on the profile view. Historical explorations from the DWR ULE project are shown; "other" historical explorations are identified by an asterisk (*) in the exploration ID. For these "other" historical borings, blow counts are field blow counts (NF) and USCS classifications are visual classifications.
 - USCS classification labels are not presented on the stick logs for soil lenses (thickness less than 1.5 feet).
 - This is a color figure. Black and white reproduction should not be relied upon as data will be lost.
 - To prevent scale distortion, this map should be printed on a "D" size sheet (22x34 inches).
 - Surficial geology was mapped at 1:20,000 scale. (Source: SGRD for DWR ULE Project, URS, 2010).
 - The information provided in these plans and stick-log plates has been compiled from a variety of sources. URS does not attest to the accuracy, completeness, or reliability of geotechnical exploration and other subsurface data by others that are included or referenced in these plates.
 - These plans and stick-log plates are for the use and benefit of HDR, SBFCA, and their consultants in connection with the execution of the FRWL Project. Use by any other party is at their own discretion and risk. These figures should not be used as the sole basis for design, construction, remedial action, or major capital spending decisions.
 - The canal/ditch elevations are approximate. These elevations were estimated from the topography.

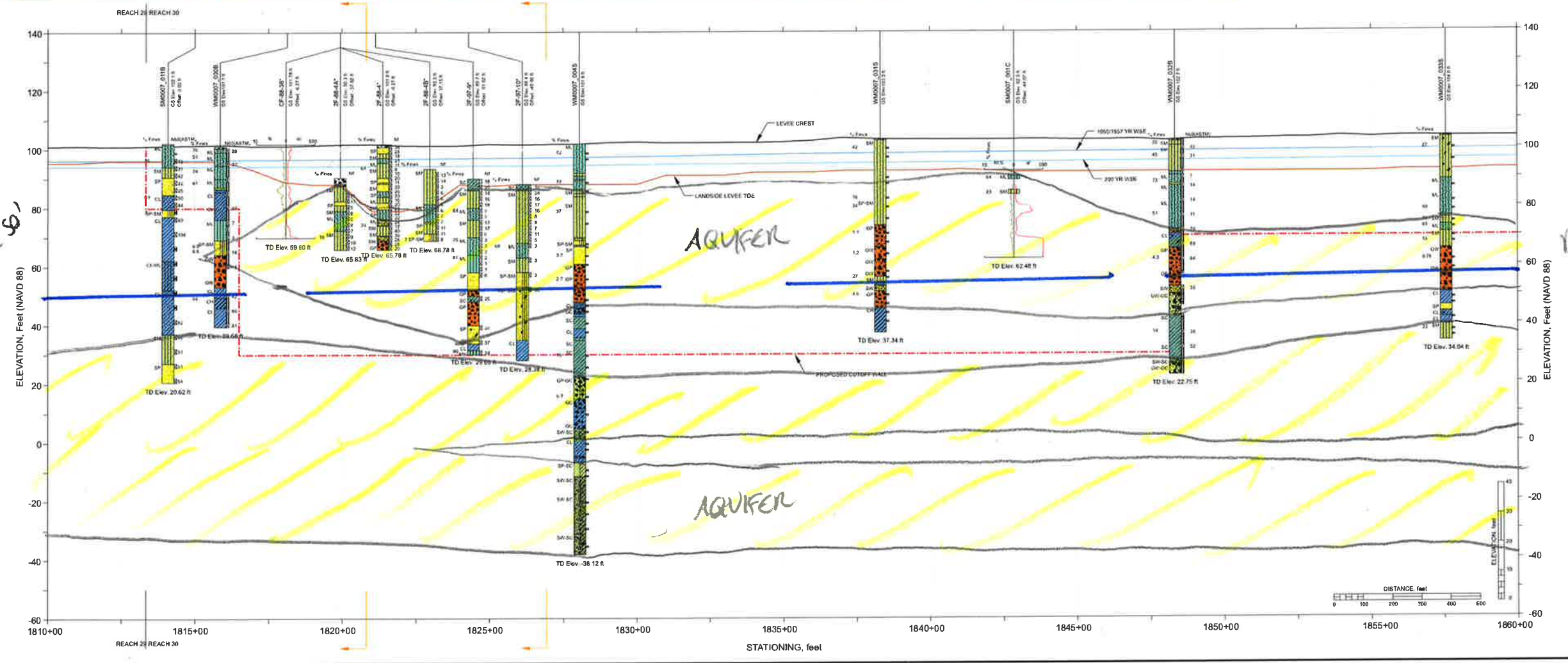

NEW WALL CUTS OFF UPPER AQUIFER

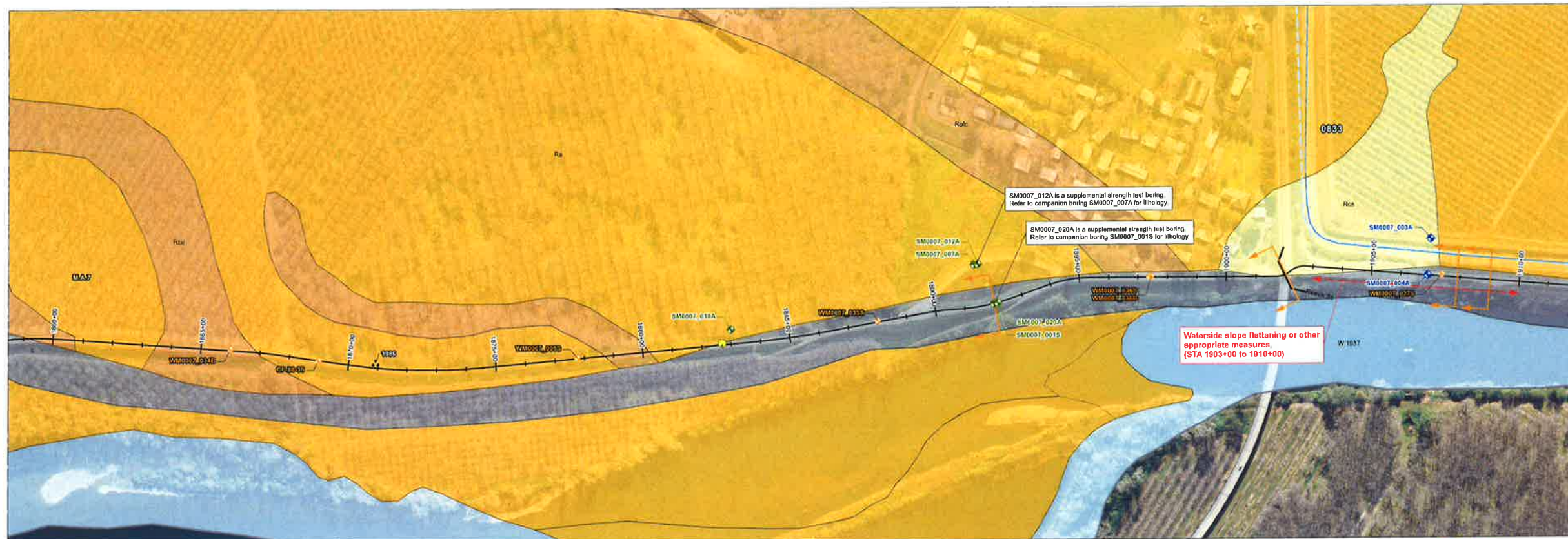

- 0 100 200 Feet
- NOTES:
- Elevations of levee crown and landside toe are approximate. These elevations were obtained from DWR CVFED or ULE LIDAR data and used for geotechnical analyses and report purpose only. For detail crown elevation and landside toe information, please refer to the FRWL Project civil drawings.
 - The water surface elevations are based on information provided by Peterson Brunsdell, Inc. in their July 26, 2012 report entitled "Design Water Surface Profiles for the Feather River West Levee Rehabilitation Project Addendum #1".
 - Locations of explorations are approximate. Stick logs represent general soil conditions encountered at the time of exploration. For more detailed information on the materials encountered, refer to boring and CPT logs in the Geotechnical Data Report for the FRWL Project. No warranty is provided regarding the continuity of soil conditions between individual explorations.
 - When reported, $N_{60}(ASTM)$, refers to $N_{60}(ASTM) = N_{60} * \text{Hammer Efficiency} (\%)$. See Geotechnical Data Report for the FRWL Project for hammer efficiency data for individual borings.
 - These drawings do not include all historical explorations on the profile view. Historical explorations from the DWR ULE project are shown; "other" historical explorations are identified by an asterisk (*) in the exploration ID. For these "other" historical borings, blow counts are field blow counts (NI) and USCS classifications are visual classifications.
 - USCS classification labels are not presented on the stick logs for soil lenses (thickness less than 1.5 feet).
 - This is a color figure. Black and white reproduction should not be relied upon as data will be lost.
 - To prevent scale distortion, this map should be printed on a "D" size sheet (22x34 inches).
 - Surficial geology was mapped at 1:20,000 scale. (Source: SGRD for DWR ULE Project, URS, 2010).
 - The information provided in these plans and stick-log plates has been compiled from a variety of sources. URS does not attest to the accuracy, completeness, or reliability of geotechnical exploration and other subsurface data by others that are included or referenced in these plates.
 - These plans and stick-log plates are for the use and benefit of HDR, SBFCA, and their consultants in connection with the execution of the FRWL Project. Use by any other party is at their own discretion and risk. These figures should not be used as the sole basis for design, construction, remedial action, or major capital spending decisions.
 - The canal/ditch elevations are approximate. These elevations were estimated from the topography.

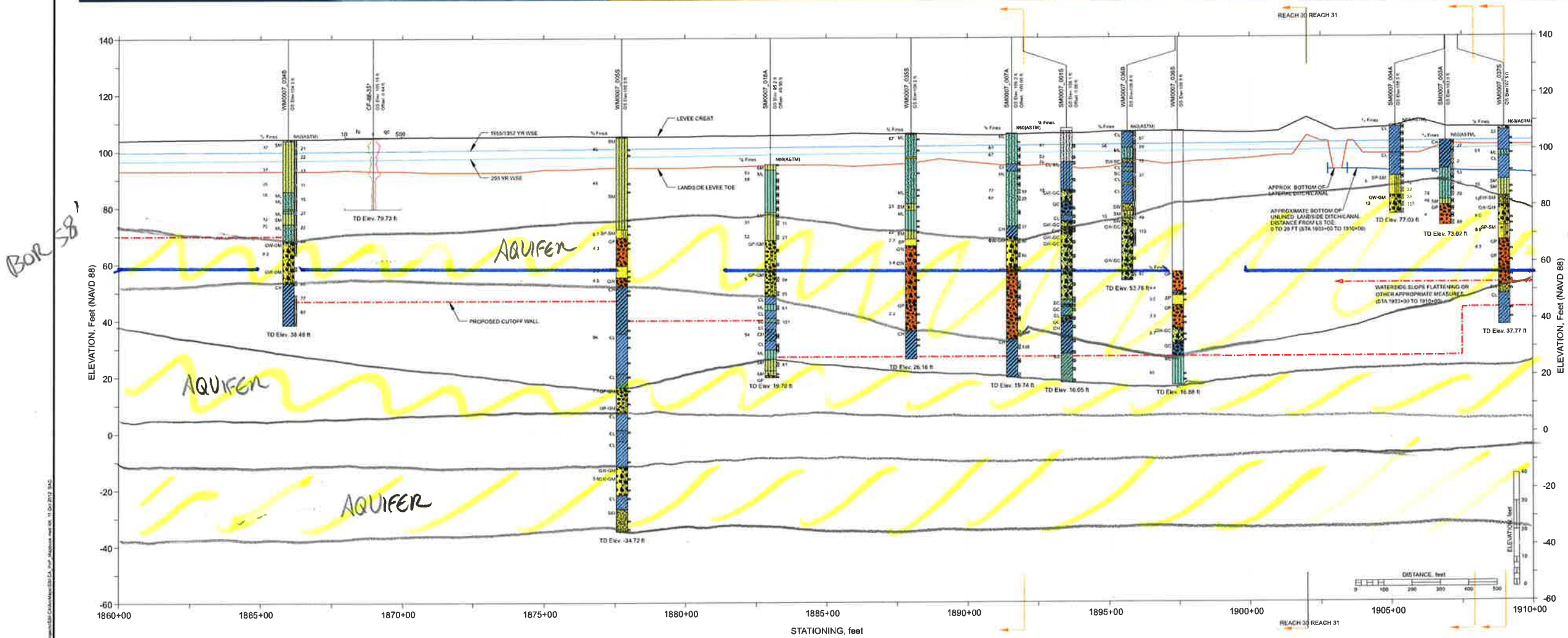

NEW WALL CUTS OFF UPPER AQUIFER



- 0 100 200 Feet
- NOTES:
- Elevations of levee crown and landside toe are approximate. These elevations were obtained from DWR CVFED or ULE LIDAR data and used for geotechnical analyses and report purpose only. For detail crown elevation and landside toe information, please refer to the FRWL Project civil drawings.
 - The water surface elevations are based on information provided by Peterson Brustad, Inc. in their July 26, 2012 report entitled "Design Water Surface Profiles for the Feather River West Levee Rehabilitation Project Addendum #1".
 - Locations of explorations are approximate. Slick logs represent general soil conditions encountered at the time of exploration. For more detailed information on the materials encountered, refer to boring and CPT logs in the Geotechnical Data Report for the FRWL Project. No warranty is provided regarding the continuity of soil conditions between individual explorations.
 - When reported, N_{60} (ASTM), refers to N_{60} (ASTM) = N_{60} * Hammer Efficiency (%). See Geotechnical Data Report for the FRWL Project for hammer efficiency data for individual borings.
 - These drawings do not include all historical explorations on the profile view. Historical explorations from the DWR ULE project are shown; other historical explorations are identified by an asterisk (*) in the exploration ID. For these "other" historical borings, blow counts are field blow counts (NF) and USCS classifications are visual classifications.
 - USCS classification labels are not presented on the slick logs for soil lenses (thickness less than 1.5 feet).
 - This is a color figure. Black and white reproduction should not be relied upon as data to be lost.
 - To prevent scale distortion, this map should be printed on a D' size sheet (22x34 inches).
 - Surficial geology was mapped at 1:20,000 scale. (Source: SGRD for DWR ULE Project, URS, 2010).
 - The information provided in these plans and slick-log plates has been compiled from a variety of sources. URS does not attest to the accuracy, completeness, or reliability of geotechnical exploration and other subsurface data by others that are included or referenced in these plates.
 - These plans and slick-log plates are for the use and benefit of HDR, SBFCA, and their consultants in connection with the execution of the FRWL Project. Use by any other party is at their own discretion and risk. These figures should not be used as the sole basis for design, construction, remedial action, or major capital spending decisions.
 - The canal/ditch elevations are approximate. These elevations were estimated from the topography.

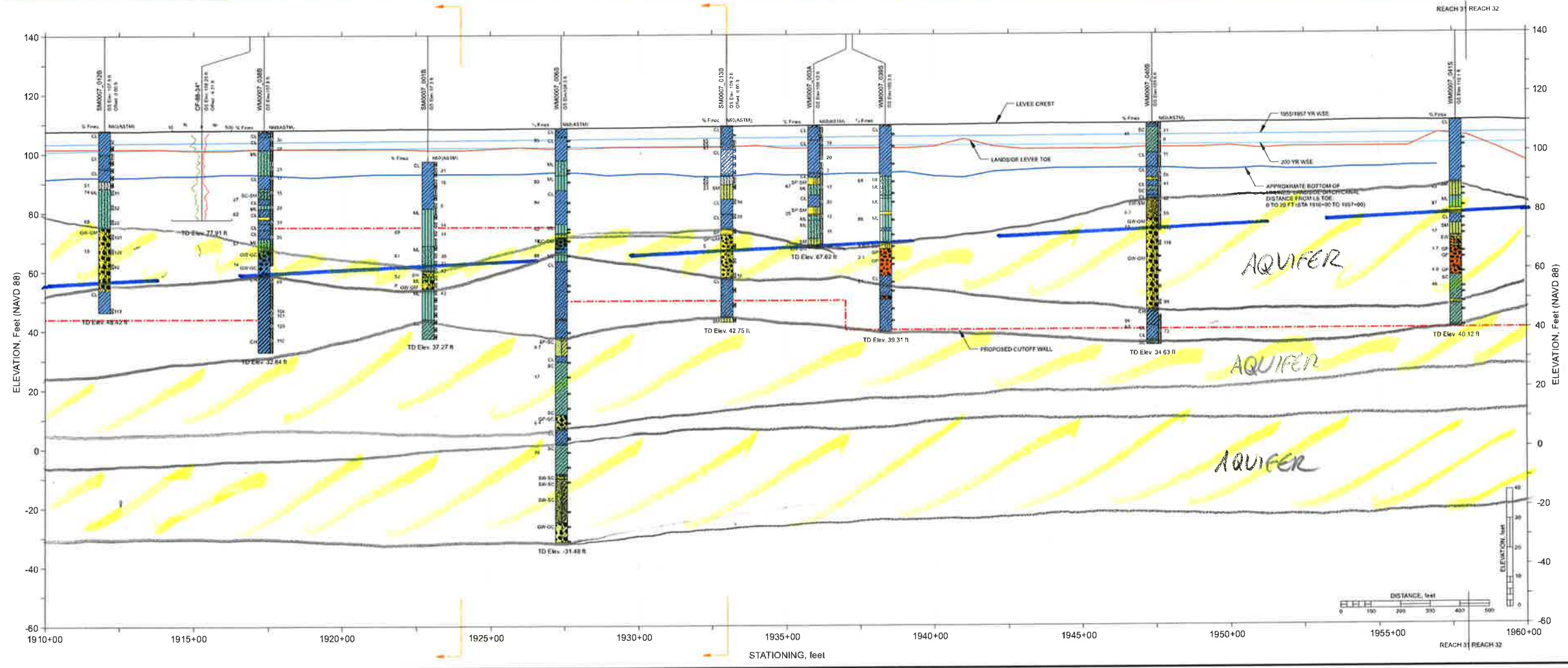

NEW WALL CUTS OFF UPPER AQUIFER

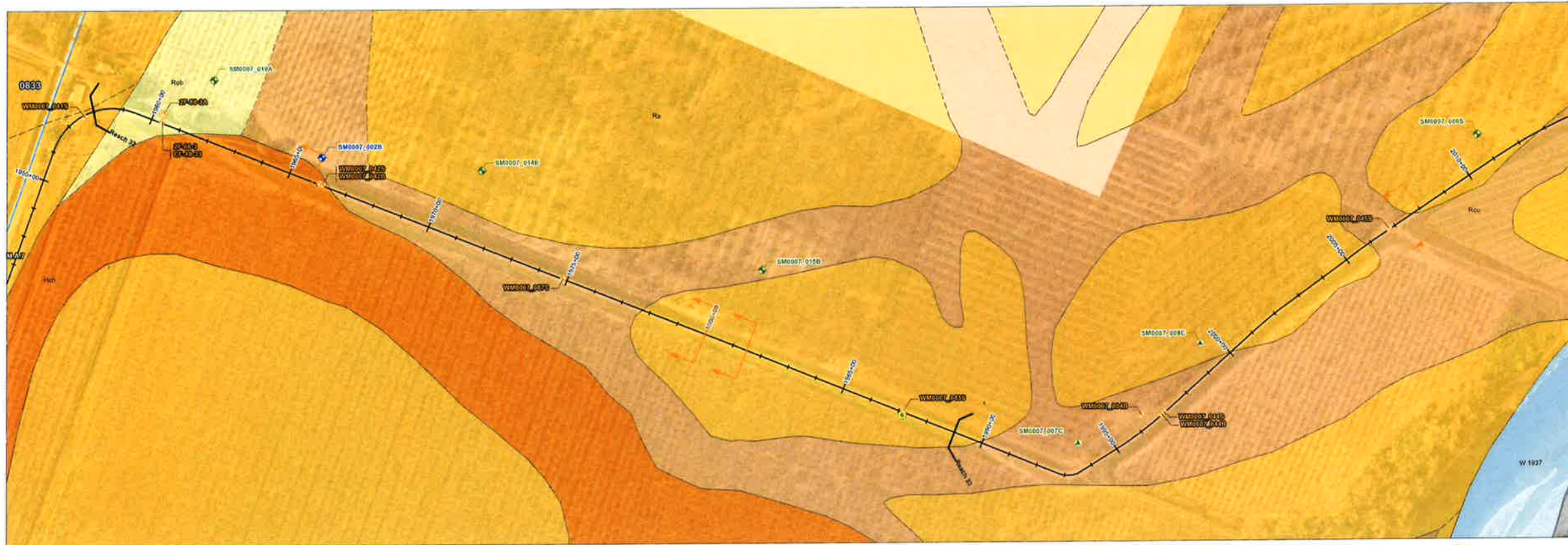

- 0 100 200
Feet
- NOTES:
1. Elevations of levee crown and landside toe are approximate. These elevations were obtained from DWR CVFED or ULE LIDAR data and used for geotechnical analyses and report purpose only. For detail crown elevation and landside toe information, please refer to the FRWL Project civil drawings.
 2. The water surface elevations are based on information provided by Peterson Brustad, Inc. in their July 26, 2012 report entitled "Design Water Surface Profiles for the Feather River West Levee Rehabilitation Project Addendum #1".
 3. Locations of explorations are approximate. Stick logs represent general soil conditions encountered at the time of exploration. For more detailed information on the materials encountered, refer to boring and CPT logs in the Geotechnical Data Report for the FRWL Project. No warranty is provided regarding the continuity of soil conditions between individual explorations.
 4. When reported, $N_{60}(ASTM)$, refers to $N_{60}(ASTM) = N_{60} \times \text{Hammer Efficiency } (\%)$. See Geotechnical Data Report for the FRWL Project for hammer efficiency data for individual borings.
 5. These drawings do not include all historical explorations on the profile view. Historical explorations from the DWR ULE project are shown; "other" historical explorations are identified by an asterisk (*) in the exploration ID. For these "other" historical borings, blow counts are field blow counts (N) and USCS classifications are visual classifications.
 6. USCS classification labels are not presented on the stick logs for soil lenses (thickness less than 1.5 feet).
 7. This is a color figure. Black and white reproduction should not be relied upon as data will be lost.
 8. To prevent scale distortion, this map should be printed on a D size sheet (22x34 inches).
 9. Surficial geology was mapped at 1:20,000 scale. (Source: SGDR for DWR ULE Project, URS, 2010).
 10. The information provided in these plans and stick-log plates has been compiled from a variety of sources. URS does not attest to the accuracy, completeness, or reliability of geotechnical exploration and other subsurface data by others that are included or referenced in these plates.
 11. These plans and stick-log plates are for the use and benefit of HDR, SBFCA, and their consultants in connection with the execution of the FRWL Project. Use by any other party is at their own discretion and risk. These figures should not be used as the sole basis for design, construction, remedial action, or major capital spending decisions.
 12. The canal/ditch elevations are approximate. These elevations were estimated from the topography.

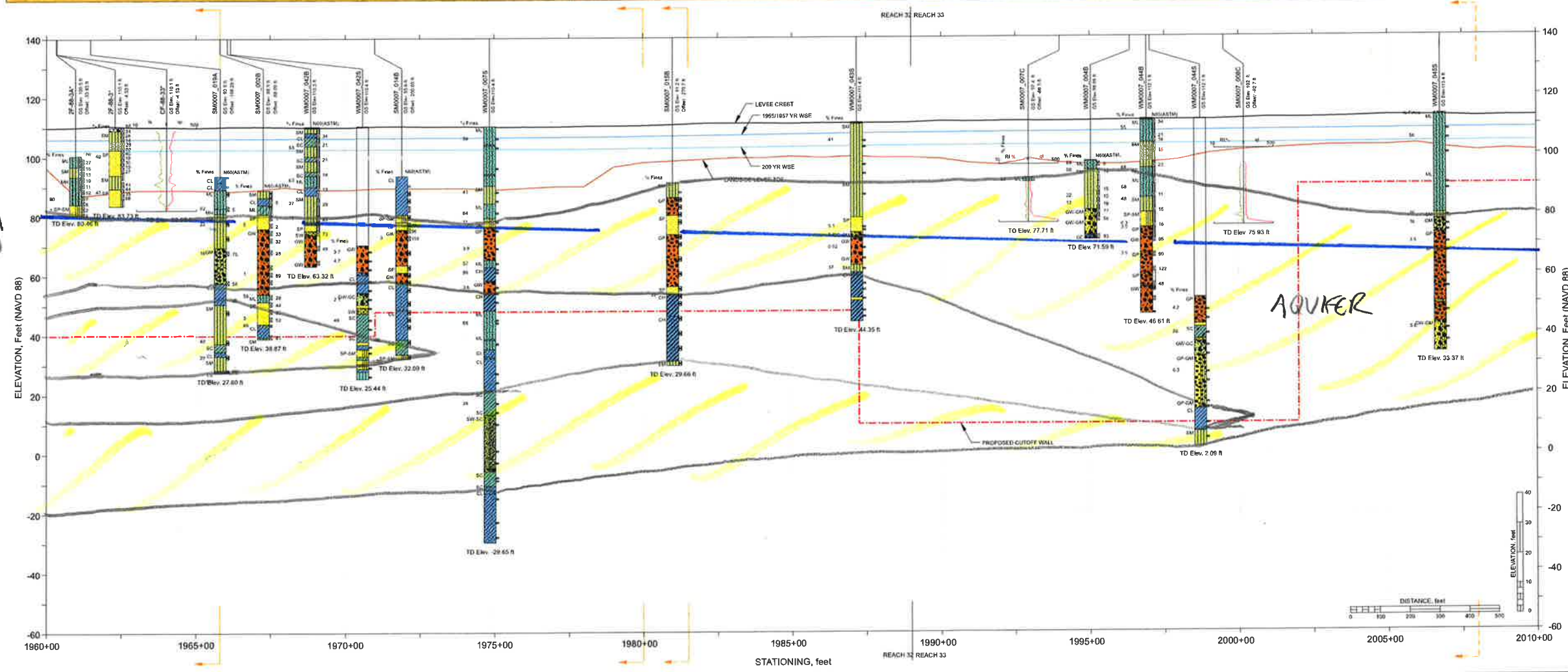

NEW WALL CUTS OFF AQUIFER

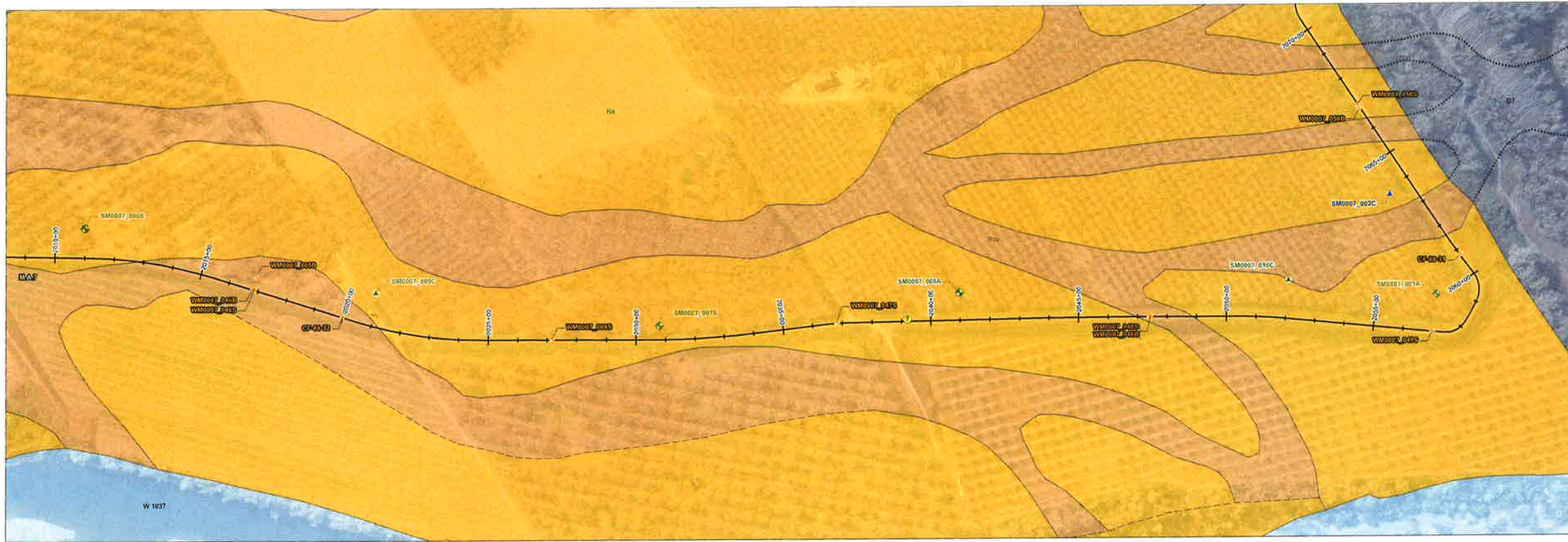

- 0 100 200 Feet
- NOTES:
- Elevations of levee crown and landside toe are approximate. These elevations were obtained from DWR CVFED or ULE LIDAR data and used for geotechnical analyses and report purpose only. For detail crown elevation and landside toe information, please refer to the FRWL Project civil drawings.
 - The water surface elevations are based on information provided by Peterson Brustad, Inc. in their July 26, 2012 report entitled "Design Water Surface Profiles for the Feather River West Levee Rehabilitation Project Addendum #1".
 - Locations of explorations are approximate. Stick logs represent general soil conditions encountered at the time of exploration. For more detailed information on the materials encountered, refer to boring and CPT logs in the Geotechnical Data Report for the FRWL Project. No warranty is provided regarding the continuity of soil conditions between individual explorations.
 - When reported, $N_{60}(ASTM)$ refers to $N_{60}(ASTM) = N_{60} \times \text{Hammer Efficiency } (\%)$. See Geotechnical Data Report for the FRWL Project for hammer efficiency data for individual borings.
 - These drawings do not include all historical explorations on the profile view. Historical explorations from the DWR ULE project are shown; "other" historical explorations are identified by an asterisk (*) in the exploration ID. For these "other" historical borings, blow counts are field blow counts (NF) and USCS classifications are visual classifications.
 - USCS classification labels are not presented on the stick logs for soil lenses (thickness less than 1.5 feet).
 - This is a color figure. Black and white reproduction should not be relied upon as data will be lost.
 - To prevent scale distortion, this map should be printed on a "D" size sheet (22x34 inches).
 - Surficial geology was mapped at 1:20,000 scale. (Source: SGDR for DWR ULE Project, URS, 2010).
 - The information provided in these plans and stick-log plates has been compiled from a variety of sources. URS does not attest to the accuracy, completeness, or reliability of geotechnical exploration and other subsurface data by others that are included or referenced in these plates.
 - These plans and stick-log plates are for the use and benefit of HDR, SBFCA, and their consultants in connection with the execution of the FRWL Project. Use by any other party is at their own discretion and risk. These figures should not be used as the sole basis for design, construction, remedial action, or major capital spending decisions.
 - The canal/ditch elevations are approximate. These elevations were estimated from the topography.

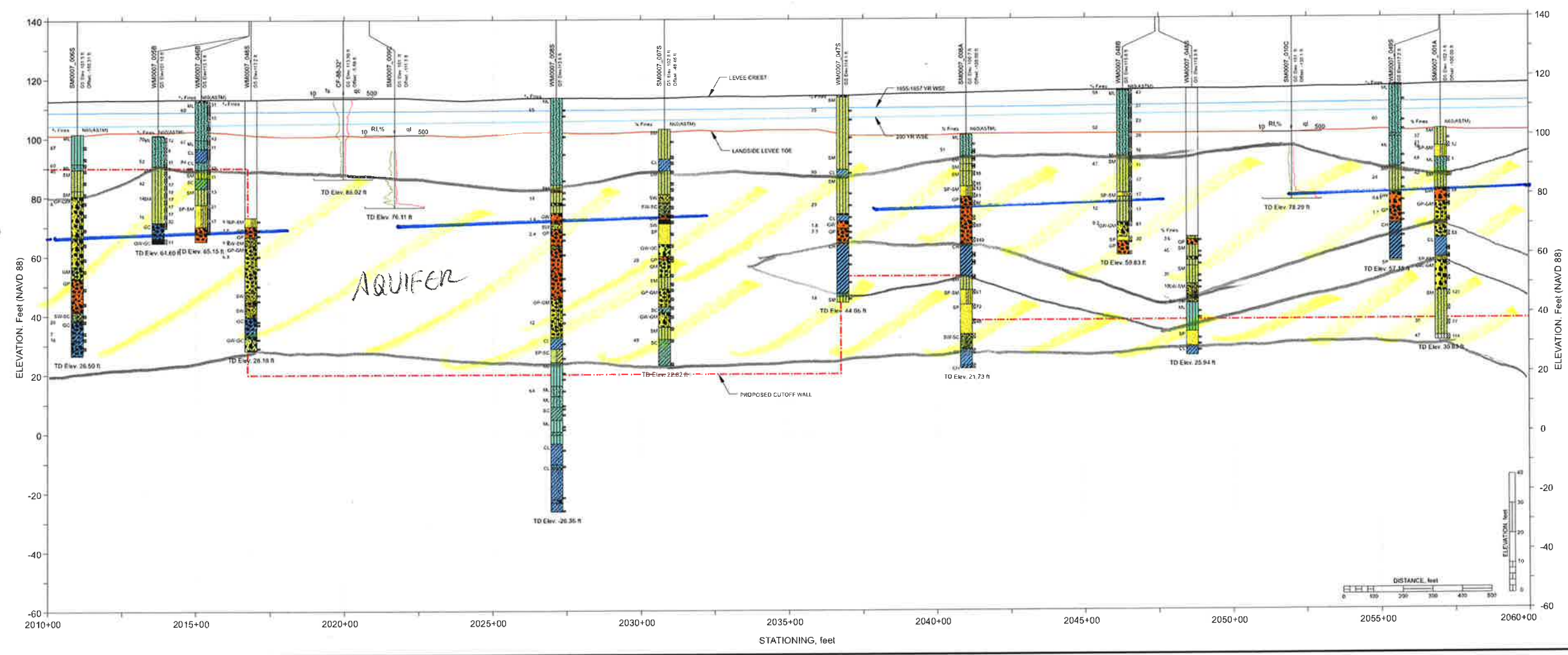

NEW WALL CUTS OFF UPPER AQUIFER

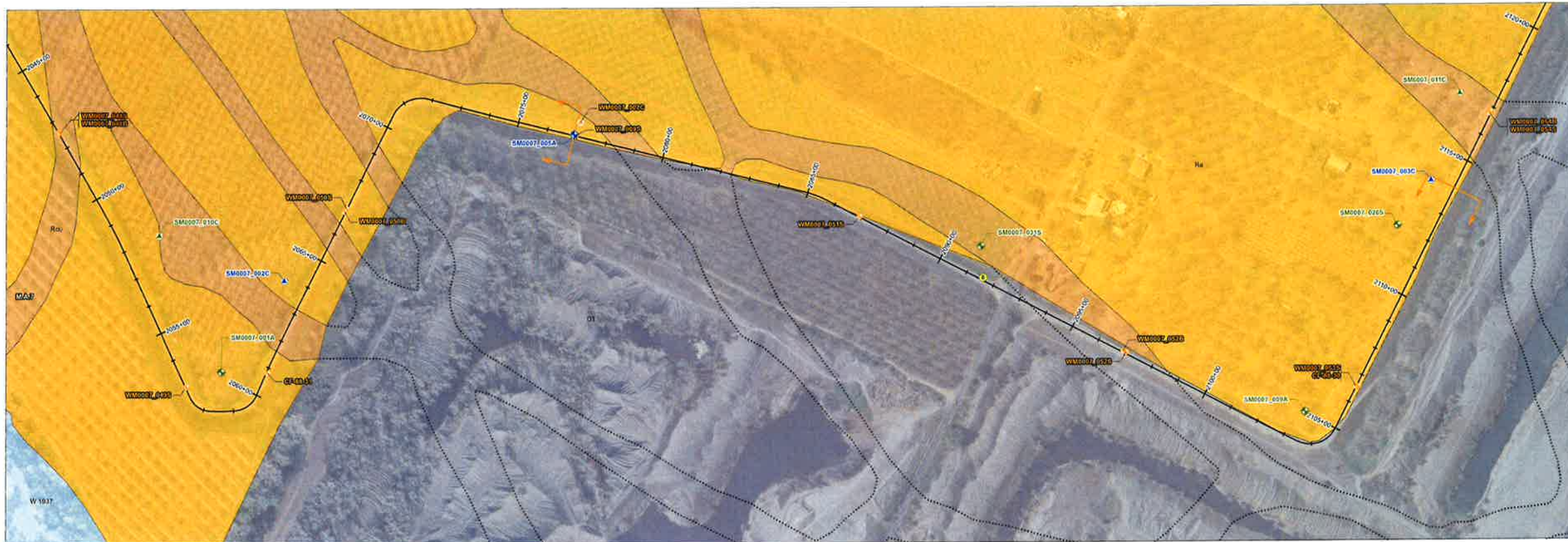

- 0 100 200 Feet
- NOTES:
- Elevations of levee crown and landside toe are approximate. These elevations were obtained from DWR CVFED or ULE LIDAR data and used for geotechnical analyses and report purpose only. For detail crown elevation and landside toe information, please refer to the FRWL Project civil drawings.
 - The water surface elevations are based on information provided by Peterson Brustad, Inc. in their July 26, 2012 report entitled "Design Water Surface Profiles for the Feather River West Levee Rehabilitation Project Addendum #1".
 - Locations of explorations are approximate. Slick logs represent general soil conditions encountered at the time of exploration. For more detailed information on the materials encountered, refer to boring and CPT logs in the Geotechnical Data Report for the FRWL Project. No warranty is provided regarding the continuity of soil conditions between individual explorations.
 - When reported, N_{60} (ASTM) refers to N_{60} (ASTM) = N_{60} * Hammer Efficiency (%). See Geotechnical Data Report for the FRWL Project for hammer efficiency data for individual borings.
 - These drawings do not include all historical explorations on the profile view. Historical explorations from the DWR ULE project are shown; "other" historical explorations are identified by an asterisk (*) in the exploration ID. For these "other" historical borings, blow counts are field blow counts (N) and USCS classifications are visual classifications.
 - USCS classification labels are not presented on the slick logs for soil lenses (thickness less than 1.5 feet).
 - This is a color figure. Black and white reproduction should not be relied upon as data will be lost.
 - To prevent scale distortion, this map should be printed on a "D" size sheet (22x34 inches).
 - Surficial geology was mapped at 1:20,000 scale. (Source: SGDR for DWR ULE Project, URS, 2010).
 - The information provided in these plans and slick-log plates has been compiled from a variety of sources. URS does not attest to the accuracy, completeness, or reliability of geotechnical exploration and other subsurface data by others that are included or referenced in these plates.
 - These plans and slick-log plates are for the use and benefit of HDR, SBFCA, and their consultants in connection with the execution of the FRWL Project. Use by any other party is at their own discretion and risk. These figures should not be used as the sole basis for design, construction, remedial action, or major capital spending decisions.
 - The canal/ditch elevations are approximate. These elevations were estimated from the topography.

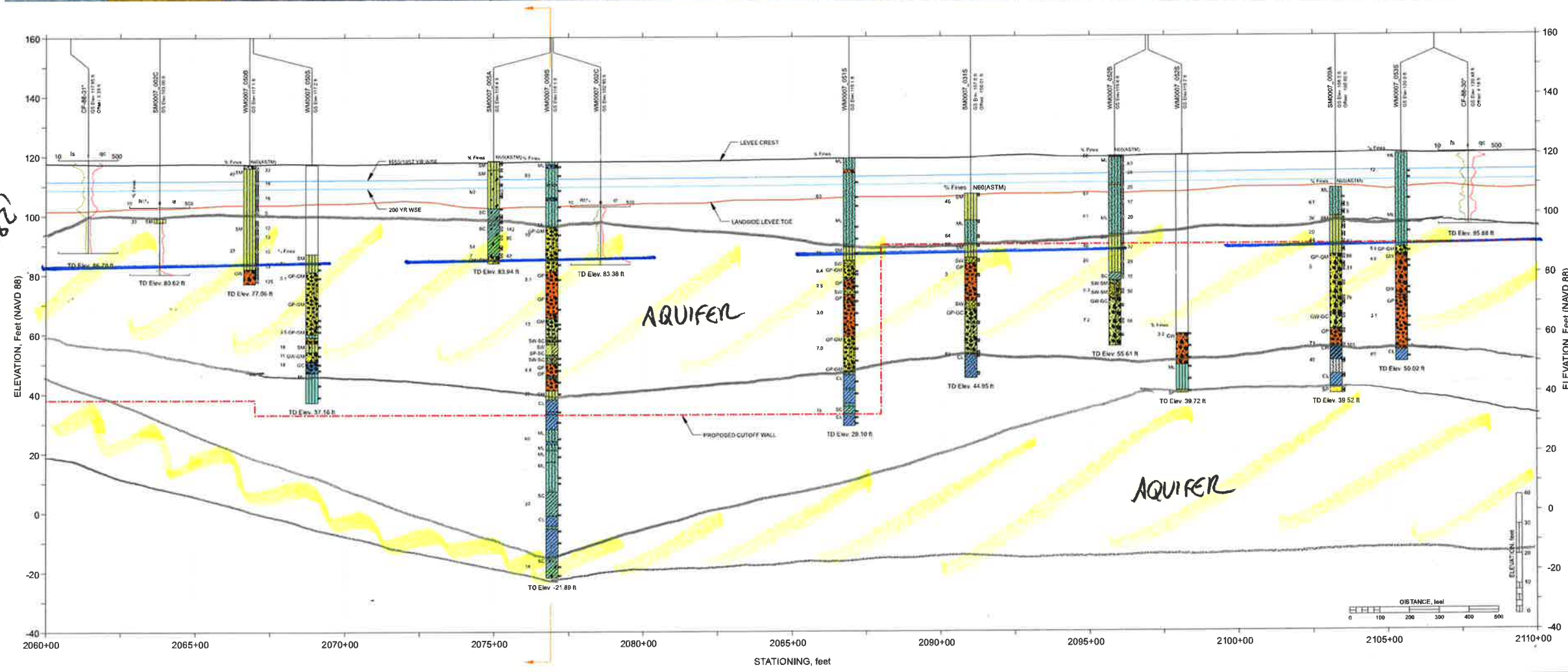

BOR 82

AQUIFER

AQUIFER

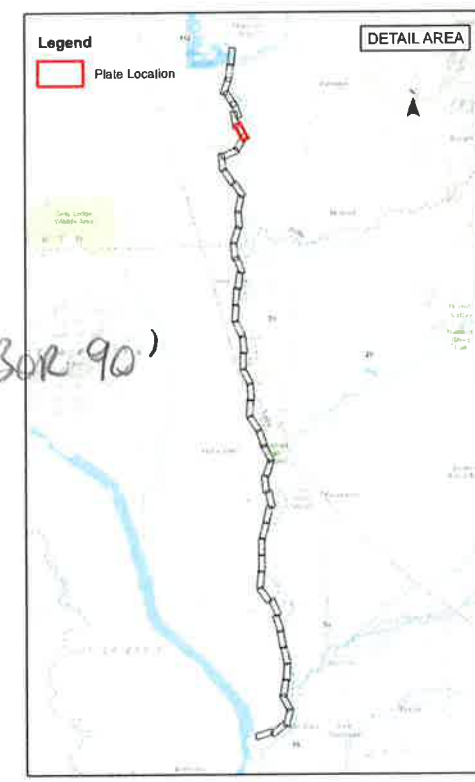

BOR 90

NEW WALL CUTS OFF AQUIFER FROM ~ STA. 2137+00 TO 2148+00

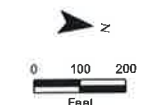
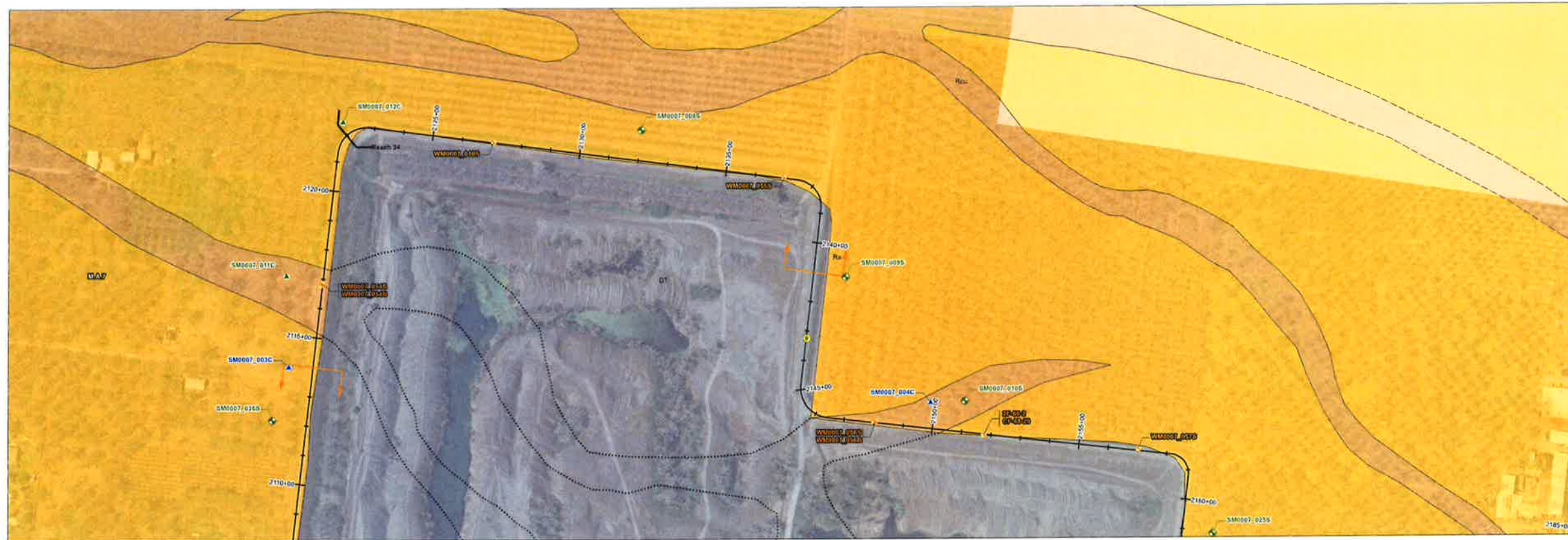

- NOTES:
1. Elevations of levee crown and landside toe are approximate. These elevations were obtained from DWR CVFED or ULE LIDAR data and used for geotechnical analyses and report purpose only. For detail crown elevation and landside toe information, please refer to the FRWL Project civil drawings.
 2. The water surface elevations are based on information provided by Peterson Brustad, Inc. in their July 26, 2012 report entitled "Design Water Surface Profiles for the Feather River West Levee Rehabilitation Project Addendum #1".
 3. Locations of explorations are approximate. Stick logs represent general soil conditions encountered at the time of exploration. For more detailed information on the materials encountered, refer to boring and CPT logs in the Geotechnical Data Report for the FRWL Project. No warranty is provided regarding the continuity of soil conditions between individual explorations.
 4. When reported, N_{60} (ASTM) refers to N_{60} (ASTM) = N_{60} * Hammer Efficiency (%). See Geotechnical Data Report for the FRWL Project for hammer efficiency data for individual borings.
 5. These drawings do not include all historical explorations on the profile view. Historical explorations from the DWR ULE project are shown; "other" historical explorations are identified by an asterisk (*) in the exploration ID. For these "other" historical borings, blow counts are field blow counts (NF) and USCS classifications are visual classifications.
 6. USCS classification labels are not presented on the stick logs for soil lenses (thickness less than 1.5 feet).
 7. This is a color figure. Black and white reproduction should not be relied upon as data will be lost.
 8. To prevent scale distortion, this map should be printed on a "D" size sheet (22x34 inches).
 9. Surficial geology was mapped at 1:20,000 scale. (Source: SGDR for DWR ULE Project, URS, 2010).
 10. The information provided in these plans and stick-log plates has been compiled from a variety of sources. URS does not attest to the accuracy, completeness, or reliability of geotechnical exploration and other subsurface data by others that are included or referenced in these plans.
 11. These plans and stick-log plates are for the use and benefit of HDR, SBFCA, and their consultants in connection with the execution of the FRWL Project. Use by any other party is at their own discretion and risk. These figures should not be used as the sole basis for design, construction, remedial action, or major capital spending decisions.
 12. The canal/ditch elevations are approximate. These elevations were estimated from the topography.

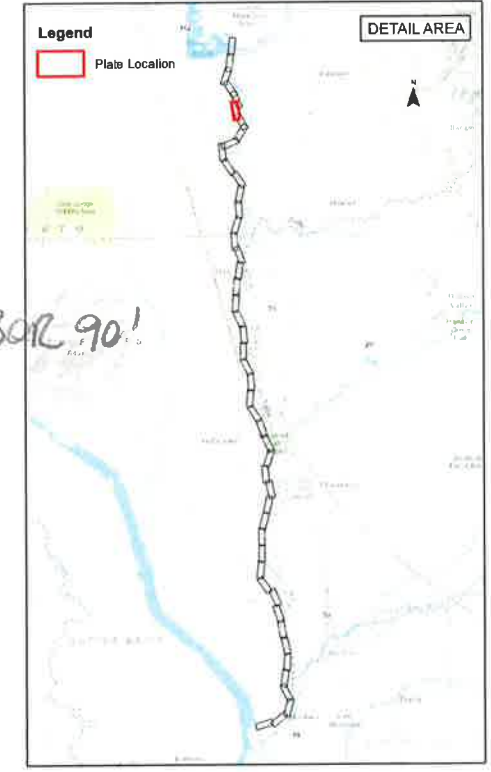
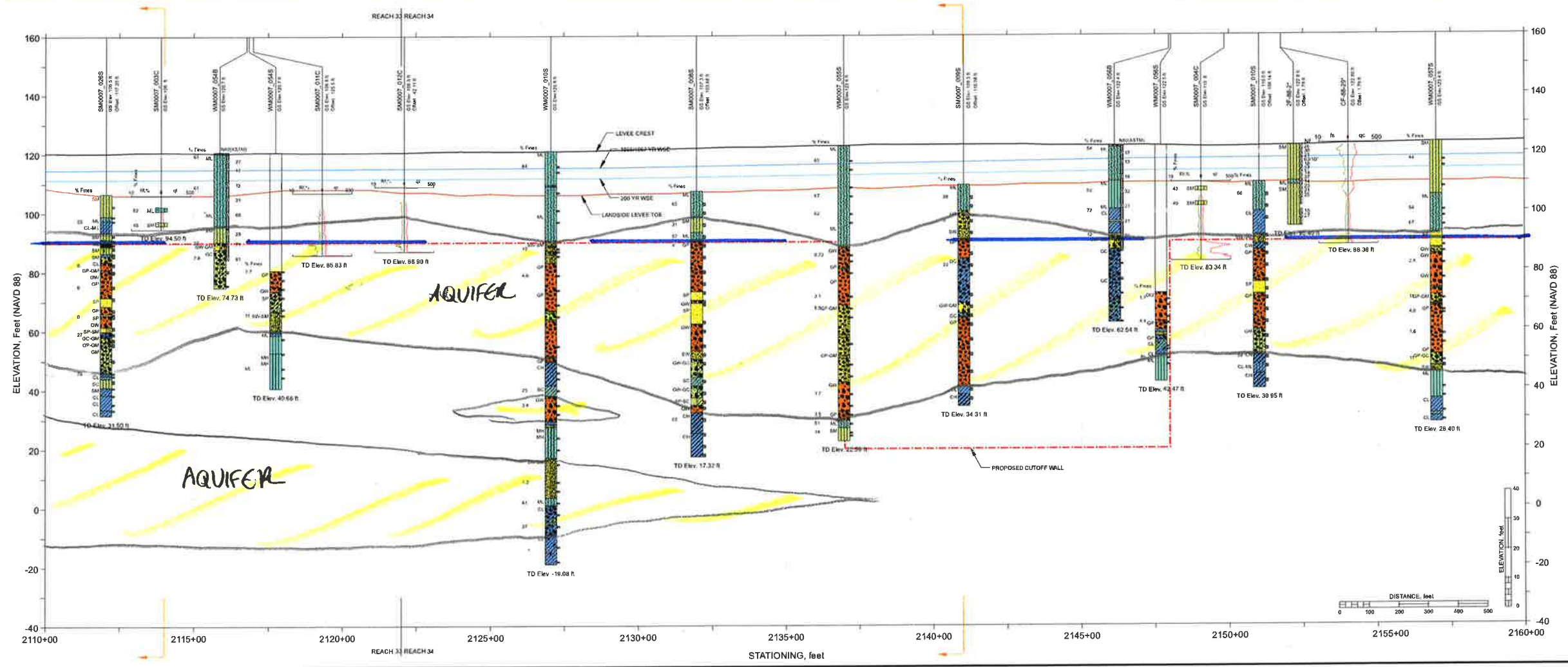

FRWL Project Plan Views and Stick Log Figures
FRWL Project: Station 2110+00 to Station 2160+00

NEW WALL CUTS OFF UPPER AQUIFER

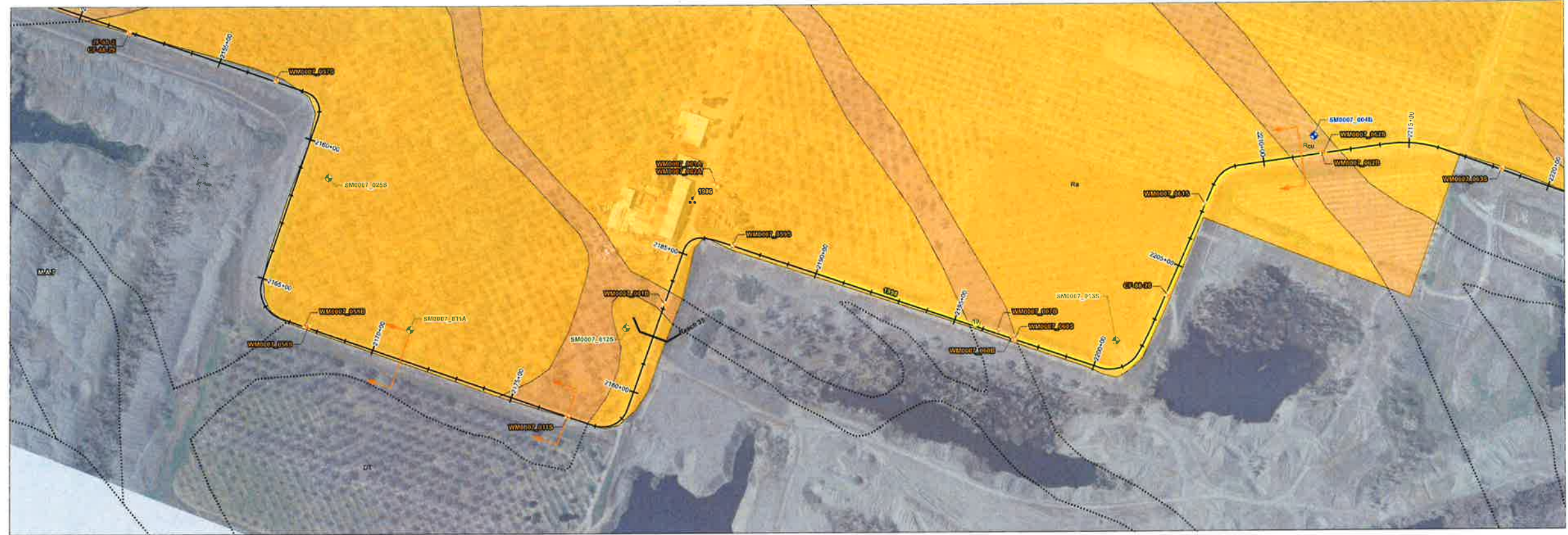

- 0 100 200 Feet
- NOTES:
- Elevations of levee crown and landside toe are approximate. These elevations were obtained from DWR CVFED or ULE LIDAR data and used for geotechnical analyses and report purpose only. For detail crown elevation and landside toe information, please refer to the FRWL Project civil drawings.
 - The water surface elevations are based on information provided by Peterson Brustad, Inc. in their July 26, 2012 report entitled "Design Water Surface Profiles for the Feather River West Levee Rehabilitation Project Addendum #1".
 - Locations of explorations are approximate. Slick logs represent general soil conditions encountered at the time of exploration. For more detailed information on the materials encountered, refer to boring and CPT logs in the Geotechnical Data Report for the FRWL Project. No warranty is provided regarding the continuity of soil conditions between individual explorations.
 - When reported, N_{60} (ASTM), refers to N_{60} (ASTM) = N_{60} , Hammer Efficiency (%). See Geotechnical Data Report for the FRWL Project for hammer efficiency data for individual borings.
 - These drawings do not include all historical explorations on the profile view. Historical explorations from the DWR ULE project are shown; "other" historical explorations are identified by an asterisk (*) in the exploration ID. For these "other" historical borings, blow counts are field blow counts (NF) and USCS classifications are visual classifications.
 - USCS classification labels are not presented on the slick logs for soil lenses (thickness less than 1.5 feet).
 - This is a color figure. Black and white reproduction should not be relied upon as data will be lost.
 - To prevent scale distortion, this map should be printed on a "D" size sheet (22x34 inches).
 - Surficial geology was mapped at 1:20,000 scale. (Source: SGRD for DWR ULE Project, URS, 2010).
 - The information provided in these plans and slick-log plates has been compiled from a variety of sources. URS does not attest to the accuracy, completeness, or reliability of geotechnical exploration and other subsurface data by others that are included or referenced in these plates.
 - These plans and slick-log plates are for the use and benefit of HDR, SBFCA, and their consultants in connection with the execution of the FRWL Project. Use by any other party is at their own discretion and risk. These figures should not be used as the sole basis for design, construction, remedial action, or major capital spending decisions.
 - The canal/ditch elevations are approximate. These elevations were estimated from the topography.

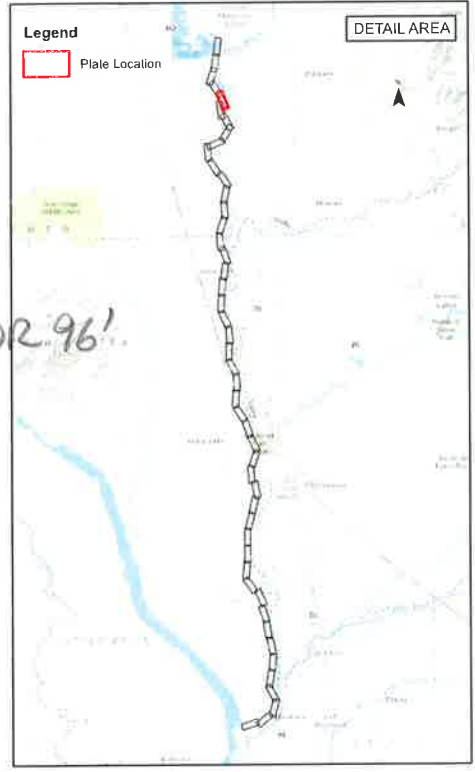
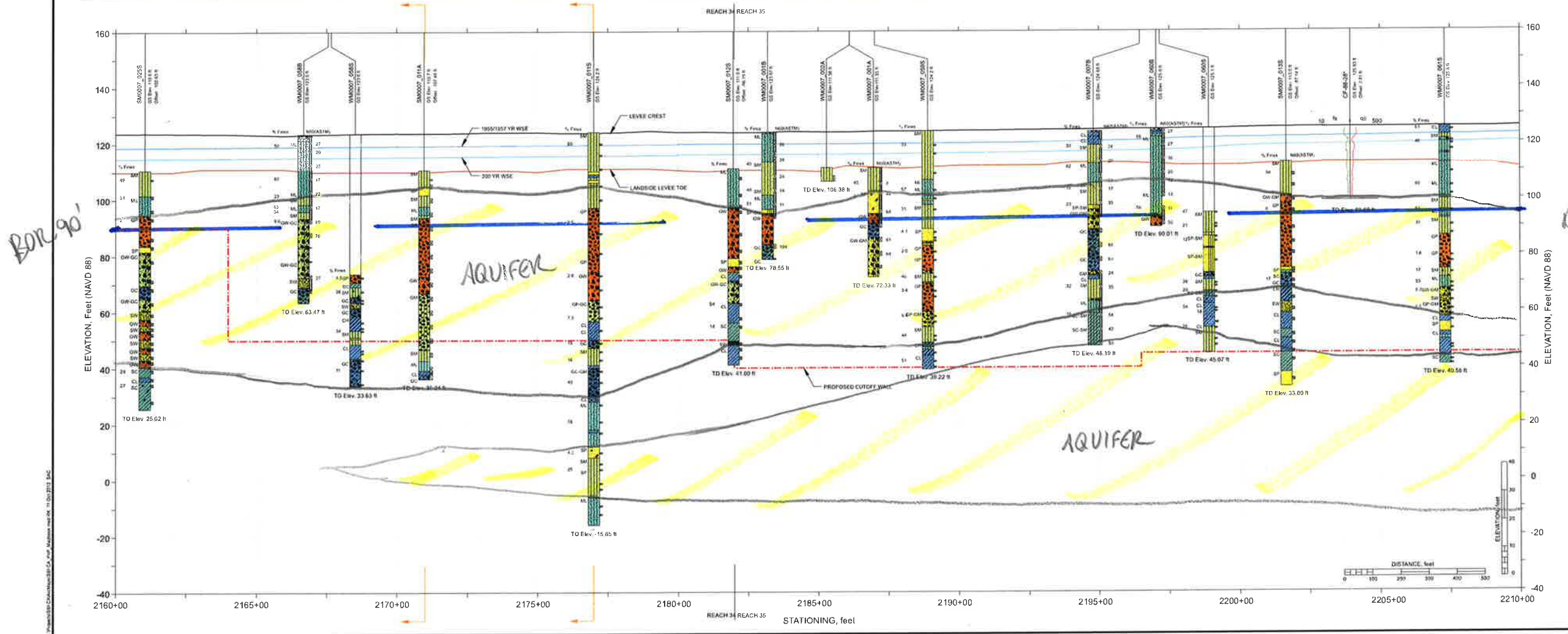

NEW WALL CUTS OFF UPPER PORTION OF AQUIFER

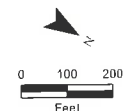
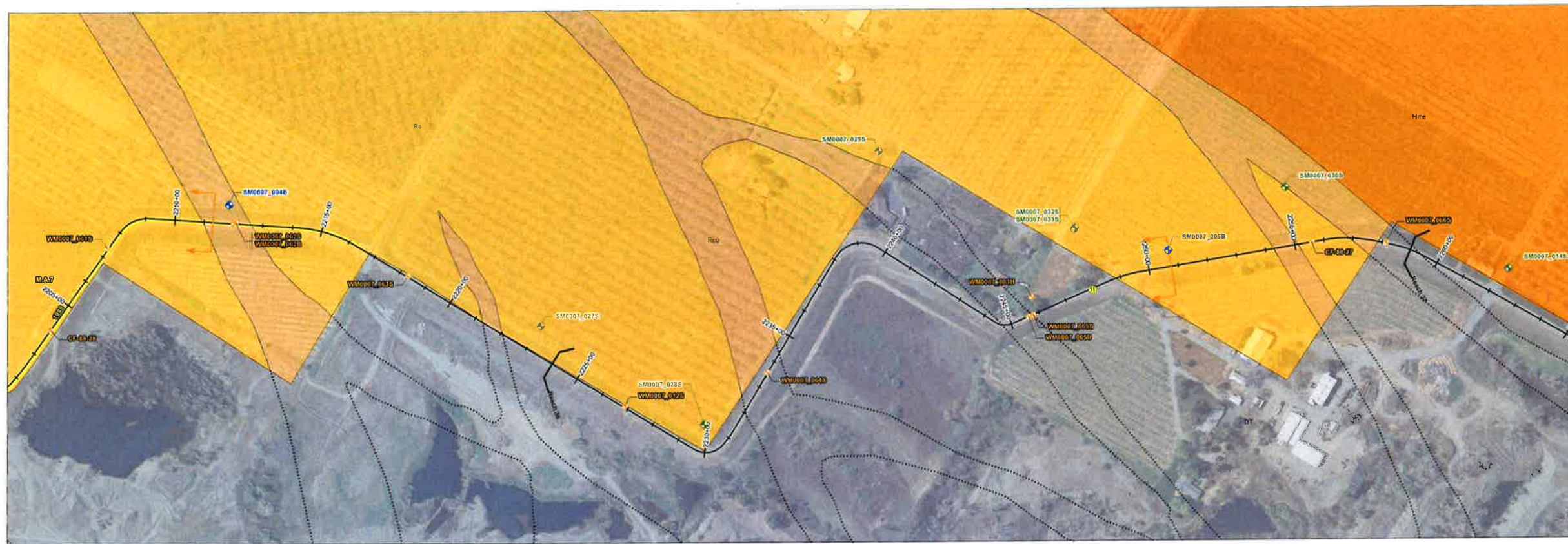

- NOTES:
- Elevations of levee crown and landside toe are approximate. These elevations were obtained from DWR CVFED or ULE LIDAR data and used for geotechnical analyses and report purpose only. For detail crown elevation and landside toe information, please refer to the FRWL Project civil drawings.
 - The water surface elevations are based on information provided by Peterson Brustad, Inc. in their July 26, 2012 report entitled "Design Water Surface Profiles for the Feather River West Levee Rehabilitation Project Addendum #1".
 - Locations of explorations are approximate. Stick logs represent general soil conditions encountered at the time of exploration. For more detailed information on the materials encountered, refer to boring and CPT logs in the Geotechnical Data Report for the FRWL Project. No warranty is provided regarding the continuity of soil conditions between individual explorations.
 - When reported, $N_{60}(ASTM) = N_{60} \cdot \text{Hammer Efficiency} (\%)$. See Geotechnical Data Report for the FRWL Project for hammer efficiency data for individual borings.
 - These drawings do not include all historical explorations on the profile view. Historical explorations from the DWR ULE Project are shown; "other" historical explorations are identified by an asterisk (*) in the exploration ID. For these "other" historical borings, blow counts are field blow counts (NF) and USCS classifications are visual classifications.
 - USCS classification labels are not presented on the stick logs for soil lenses (thickness less than 1.5 feet).
 - This is a color figure. Black and white reproduction should not be relied upon as data will be lost.
 - To prevent scale distortion, this map should be printed on a "D" size sheet (22x34 inches).
 - Surficial geology was mapped at 1:20,000 scale. (Source: SGRD for DWR ULE Project, URS, 2010).
 - The information provided in these plans and stick-log plates has been compiled from a variety of sources. URS does not attest to the accuracy, completeness, or reliability of geotechnical exploration and other subsurface data by others that are included or referenced in these plates.
 - These plans and stick-log plates are for the use and benefit of HDR, SBFCA, and their consultants in connection with the execution of the FRWL Project. Use by any other party is at their own discretion and risk. These figures should not be used as the sole basis for design, construction, remedial action, or major capital spending decisions.
 - The cantilever elevations are approximate. These elevations were estimated from the topography.

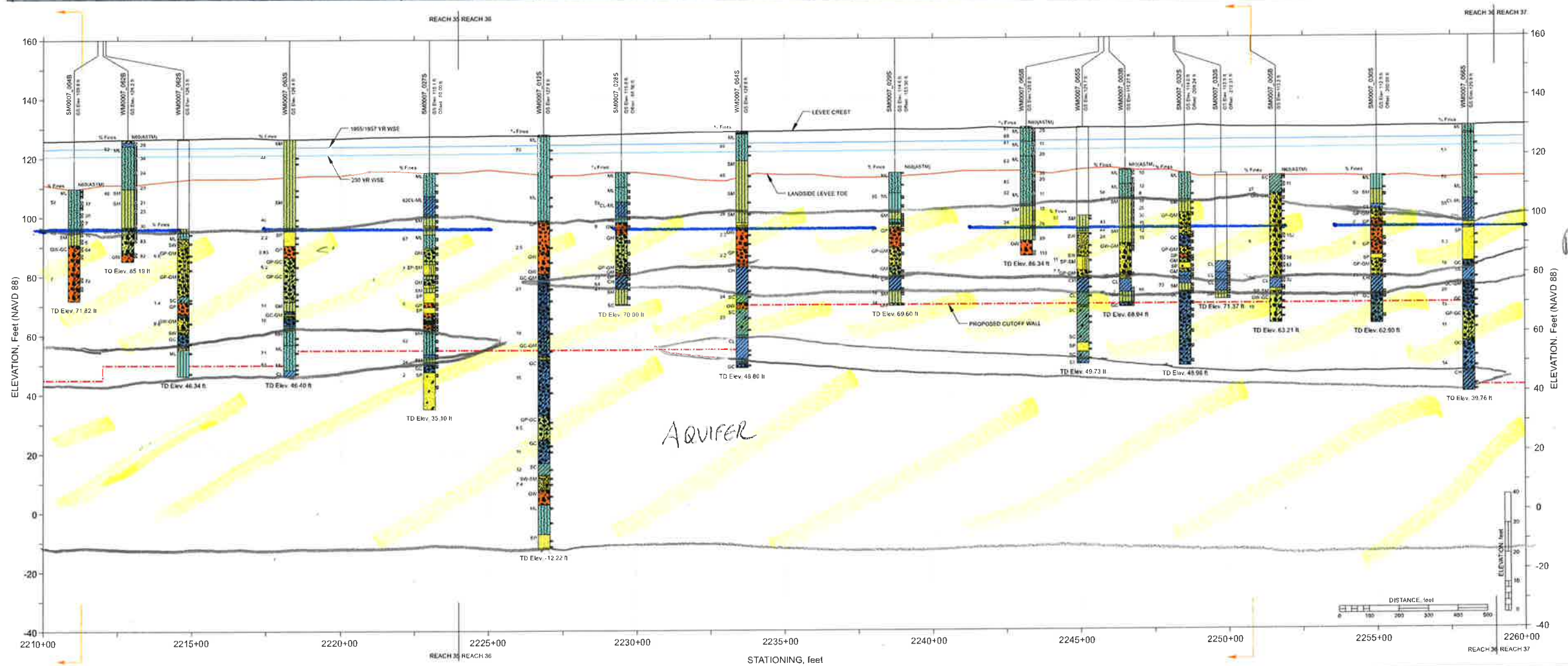

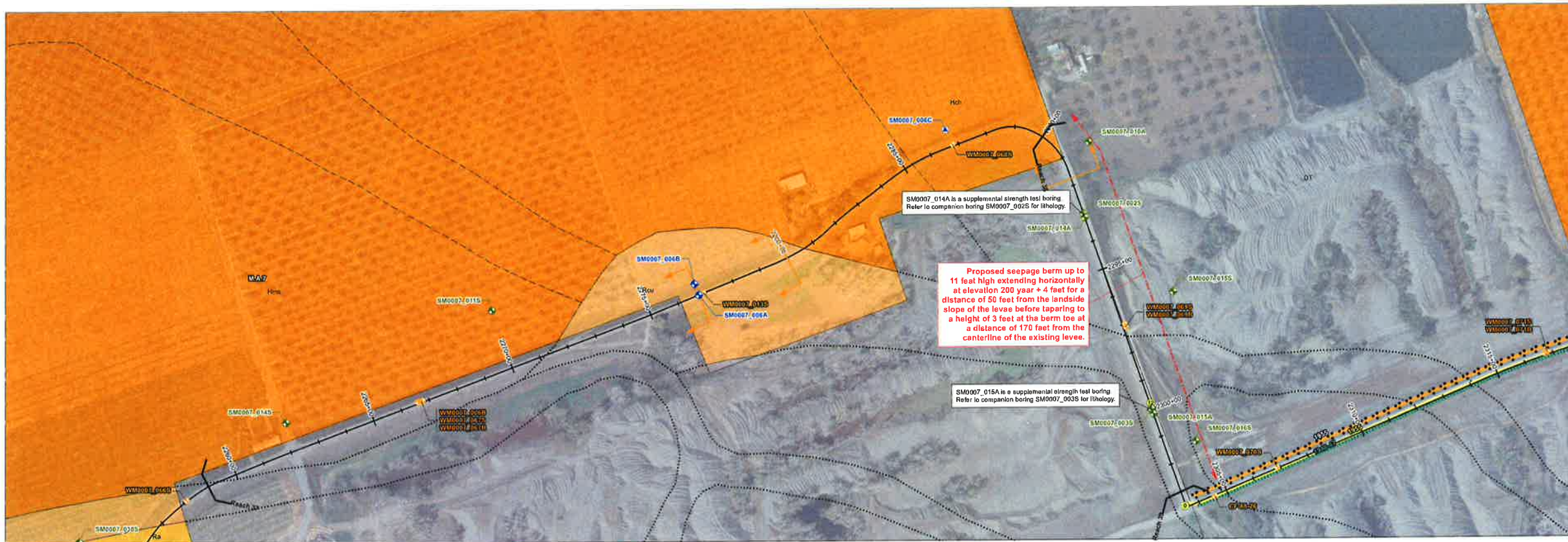

- NOTES:
- Elevations of levee crown and landside toe are approximate. These elevations were obtained from DWR CV/FED or ULE LIDAR data and used for geotechnical analyses and report purpose only. For detail crown elevation and landside toe information, please refer to the FRWL Project civil drawings.
 - The water surface elevations are based on information provided by Peterson Brustad, Inc. in their July 26, 2012 report entitled "Design Water Surface Profiles for the Feather River West Levee Rehabilitation Project Addendum #1".
 - Locations of explorations are approximate. Stick logs represent general soil conditions encountered at the time of exploration. For more detailed information on the materials encountered, refer to boring end CPT logs in the Geotechnical Data Report for the FRWL Project. No warranty is provided regarding the continuity of soil conditions between individual explorations.
 - When reported, $N_{60}(ASTM)$ refers to $N_{60}(ASTM) = N_{60} * \text{Hammer Efficiency} (\%)$. See Geotechnical Data Report for the FRWL Project for hammer efficiency data for individual borings.
 - These drawings do not include all historical explorations on the profile view. Historical explorations are identified by an asterisk (*) in the exploration ID. For these "other" historical borings, blow counts are field blow counts (NI) and USCS classifications are visual classifications.
 - USCS classification labels are not presented on the stick logs for soil lenses (thickness less than 1.5 feet).
 - This is a color figure. Black and white reproduction should not be relied upon as data will be lost.
 - To prevent scale distortion, this map should be printed on e-D size sheet (22x34 inches).
 - Surficial geology was mapped at 1:20,000 scale. (Source: SGDR for DWR ULE Project, URS, 2010).
 - The information provided in these plans and stick-log plates has been compiled from a variety of sources. URS does not attest to the accuracy, completeness, or reliability of geotechnical exploration and other subsurface data by others that are included or referenced in these plates.
 - These plans and stick-log plates are for the use and benefit of HDR, SBFCA, and their consultants in connection with the execution of the FRWL Project. Use by any other party is at their own discretion and risk. These figures should not be used as the sole basis for design, construction, remedial action, or major capital spending decisions.
 - The canal/sitch elevations are approximate. These elevations were estimated from the topography.

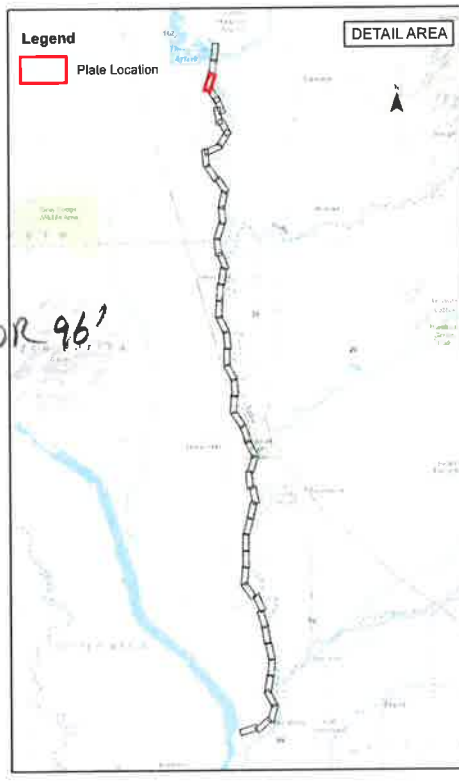
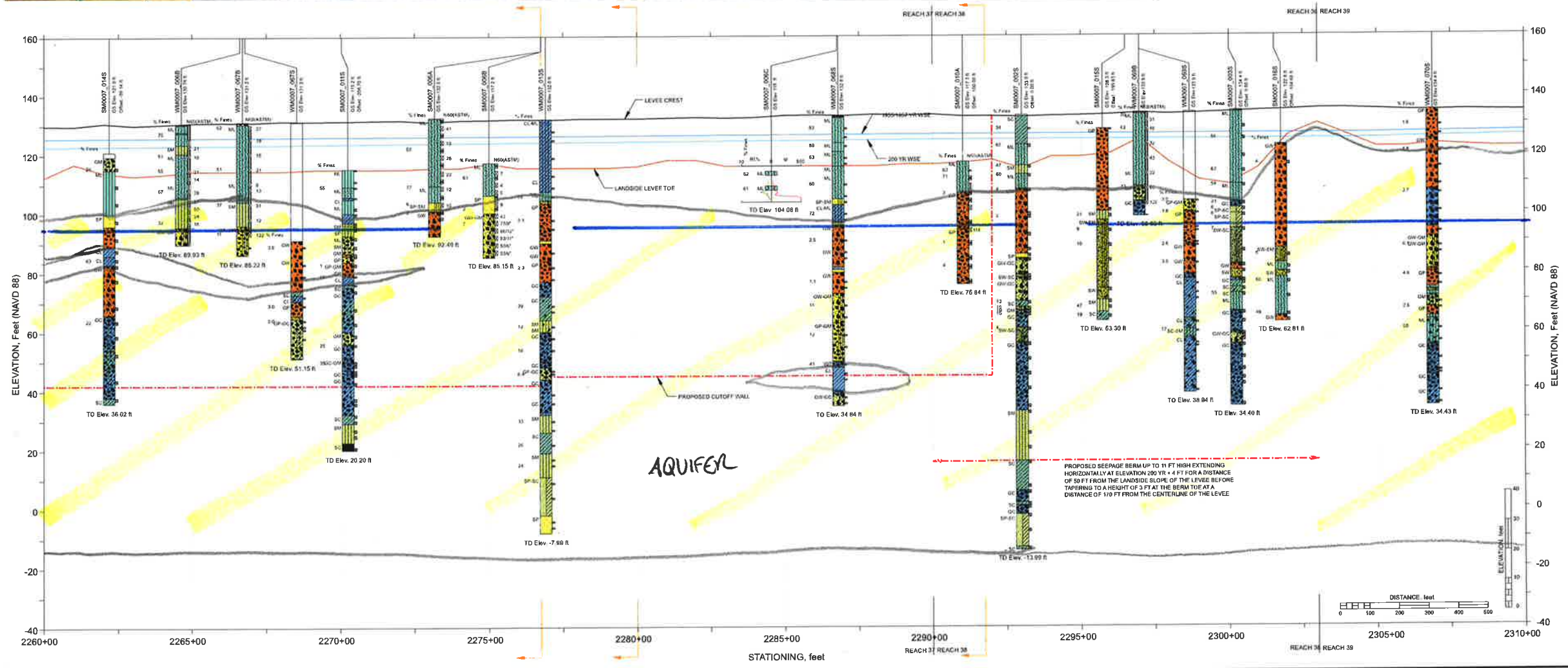



- 0 100 200 Feet
- NOTES:
- Elevations of levee crown and landside toe are approximate. These elevations were obtained from DWR CVFED or ULE LIDAR data and used for geotechnical analyses and report purpose only. For detail crown elevation and landside toe information, please refer to the FRWL Project civil drawings.
 - The water surface elevations are based on information provided by Peterson Bruslad, Inc. in their July 26, 2012 report entitled "Design Water Surface Profiles for the Feather River West Levee Rehabilitation Project Addendum #1".
 - Locations of explorations are approximate. Stick logs represent general soil conditions encountered at the time of exploration. For more detailed information on the materials encountered, refer to boring and CPT logs in the Geotechnical Data Report for the FRWL Project. No warranty is provided regarding the continuity of soil conditions between individual explorations.
 - When reported, $N_{60}(ASTM)$ refers to $N_{60}(ASTM) = N_{60} \cdot \text{Hammer Efficiency (\%)}$. See Geotechnical Data Report for the FRWL Project for hammer efficiency data for individual borings.
 - These drawings do not include all historical explorations on the profile view. Historical explorations from the DWR ULE project are shown; "other" historical explorations are identified by an asterisk (*) in the exploration ID. For these "other" historical borings, blow counts are field blow counts (NF) and USCS classifications are visual classifications.
 - USCS classification labels are not presented on the stick logs for soil lenses (thickness less than 1.5 feet).
 - This is a color figure. Black and white reproduction should not be relied upon as data will be lost.
 - To prevent scale distortion, this map should be printed on a "D" size sheet (22x34 inches).
 - Surficial geology was mapped at 1:20,000 scale. (Source: SGRD for DWR ULE Project, URS, 2010).
 - The information provided in these plans and stick-log plates has been compiled from a variety of sources. URS does not attest to the accuracy, completeness, or reliability of geotechnical exploration and other subsurface data by others that are included or referenced in these plates.
 - These plans and stick-log plates are for the use and benefit of HDR, SBFA, and their consultants in connection with the execution of the FRWL Project. Use by any other party is at their own discretion and risk. These figures should not be used as the sole basis for design, construction, remedial action, or major capital spending decisions.
 - The canal/ditch elevations are approximate. These elevations were estimated from the topography.

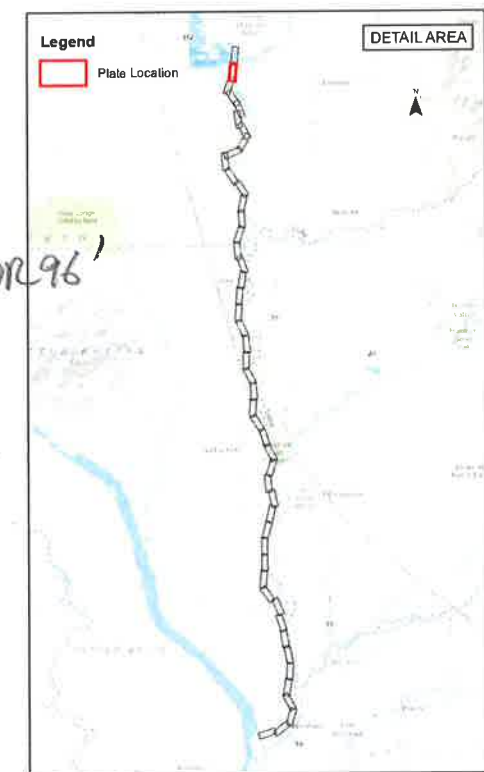
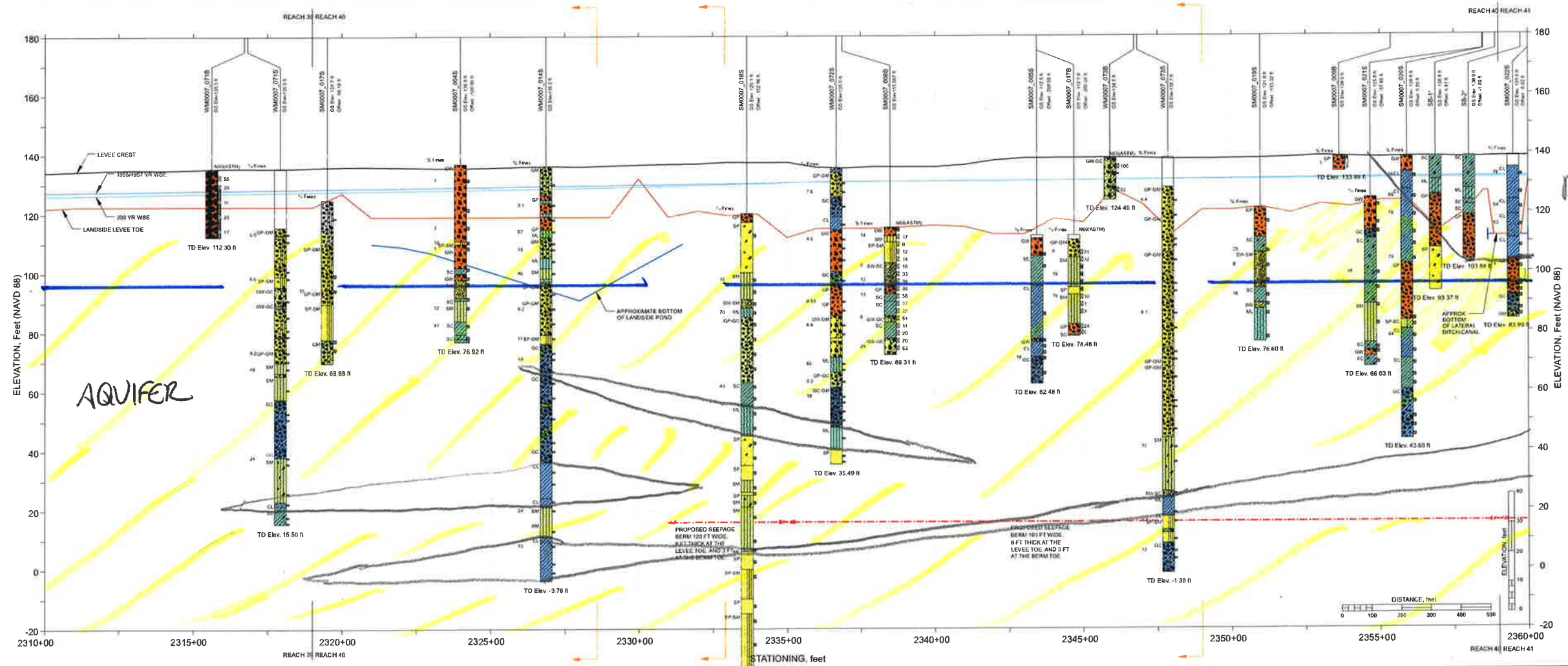

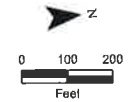

- NOTES:
1. Elevations of levee crown and landside toe are approximate. These elevations were obtained from DWR CVFED or ULE LIDAR data and used for geotechnical analyses and report purpose only. For detail crown elevation and landside toe information, please refer to the FRWL Project civil drawings.
 2. The water surface elevations are based on information provided by Peterson Brustad, Inc. in their July 26, 2012 report entitled "Design Water Surface Profiles for the Feather River West Levee Rehabilitation Project Addendum #1".
 3. Locations of explorations are approximate. Stick logs represent general soil conditions encountered at the time of exploration. For more detailed information on the materials encountered, refer to boring and CPT logs in the Geotechnical Data Report for the FRWL Project. No warranty is provided regarding the continuity of soil conditions between individual explorations.
 4. When reported, $N_{60}(ASTM)$, refers to $N_{60}(ASTM) = N_{60}$ * Hammer Efficiency (%). See Geotechnical Data Report for the FRWL Project for hammer efficiency data for individual borings.
 5. These drawings do not include all historical explorations on the profile view. Historical explorations from the DWR ULE project are shown; "other" historical explorations are identified by an asterisk (*) in the exploration ID. For these "other" historical borings, blow counts are field blow counts (NF) and USCS classifications are visual classifications.
 6. USCS classification labels are not presented on the stick logs for soil lenses (thickness less than 1.5 feet).
 7. This is a color figure. Black and white reproduction should not be relied upon as data will be lost.
 8. To prevent scale distortion, this map should be printed on a "D" size sheet (22x34 inches).
 9. Surficial geology was mapped at 1:20,000 scale. (Source: SCDR for DWR ULE Project, URS, 2010).
 10. The information provided in these plans and stick-log plates has been compiled from a variety of sources. URS does not attest to the accuracy, completeness, or reliability of geotechnical exploration and other subsurface data by others that are included or referenced in these plates.
 11. These plans and stick-log plates are for the use and benefit of HDR, SBFCA, and their consultants in connection with the execution of the FRWL Project. Use by any other party is at their own discretion and risk. These figures should not be used as the sole basis for design, construction, remedial action, or major capital spending decisions.
 12. The canal/ditch elevations are approximate. These elevations were estimated from the topography.

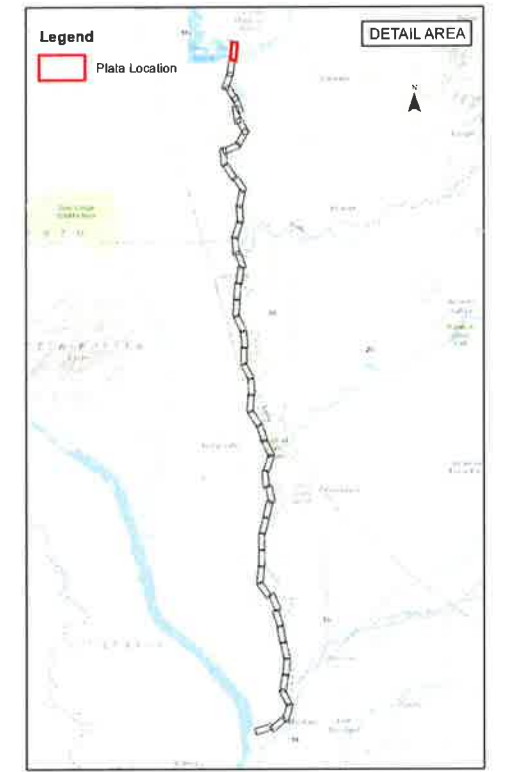
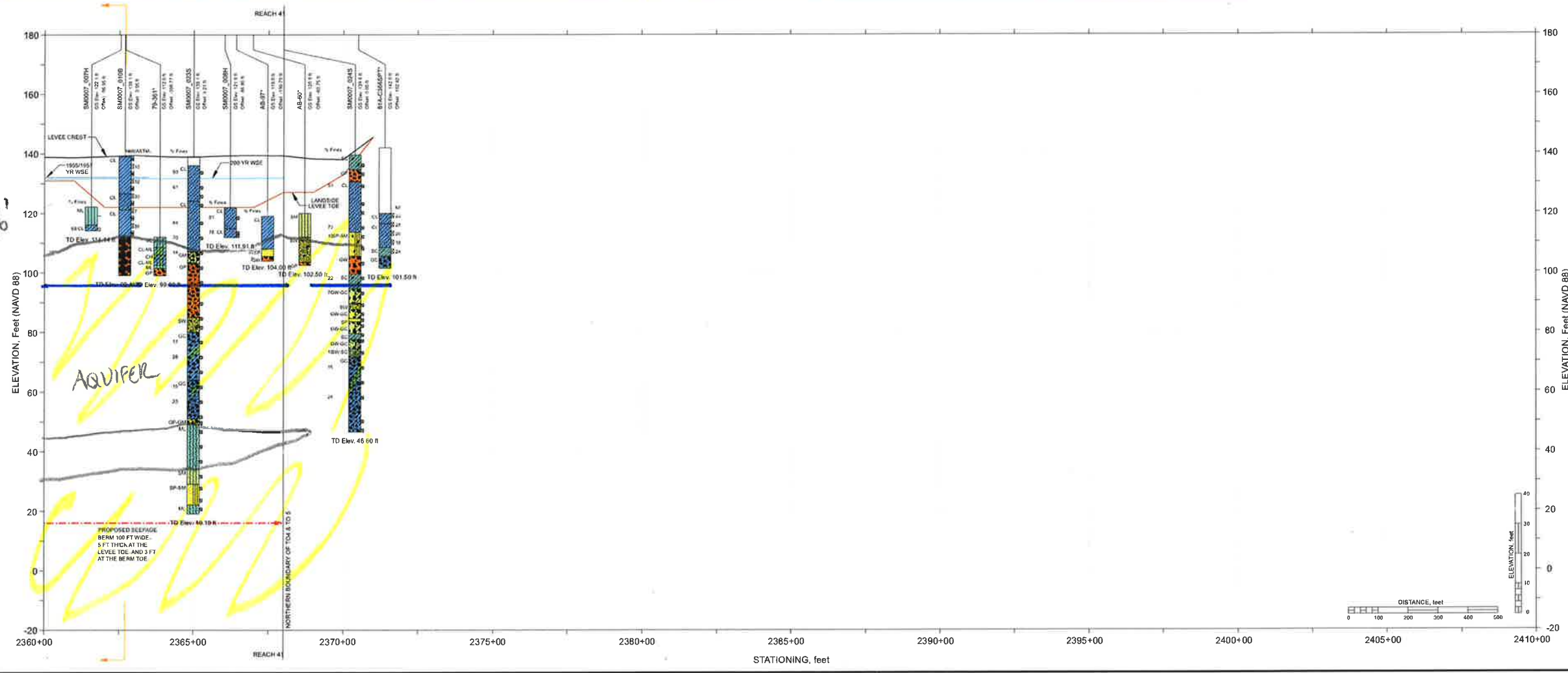

FRWL Project Plan Views and Stick Log Figures
FRWL Project: Station 2360+00 to Station 2372+17

URS Geotechnical Design
Recommendations Report

Sutter Butte Flood Control Agency
FEATHER RIVER WEST LEVEE PROJECT

Appendix
A50

This page intentionally left blank.

Appendix 5-C
Geologic Sections – Sacramento River Levees

This page intentionally left blank.

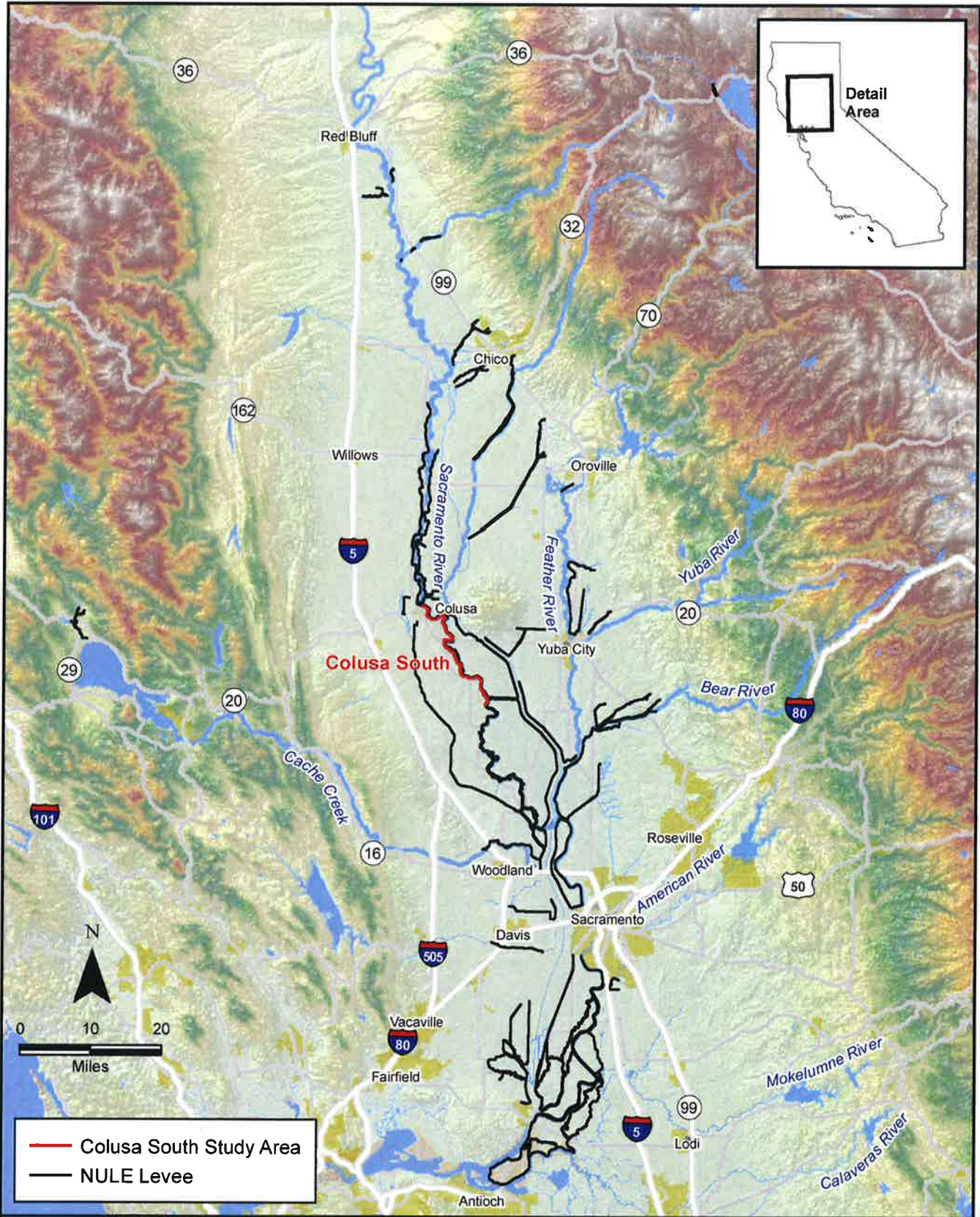

L:\Projects\DW\GEOTECHNICAL\Nor_Urban\GORTOC_NNULE_GOR\Figures\Colusa\South\VOL1\MXD\WCA\GORTOC_PETA1_3.mxd AMN 06/11/2014 SAC

— Colusa South Study Area
 — NULE Levee



Department of Water Resources
 Division of Flood Management



Colusa South Study Area

NON-URBAN LEVEE EVALUATIONS

Figure
 1-3

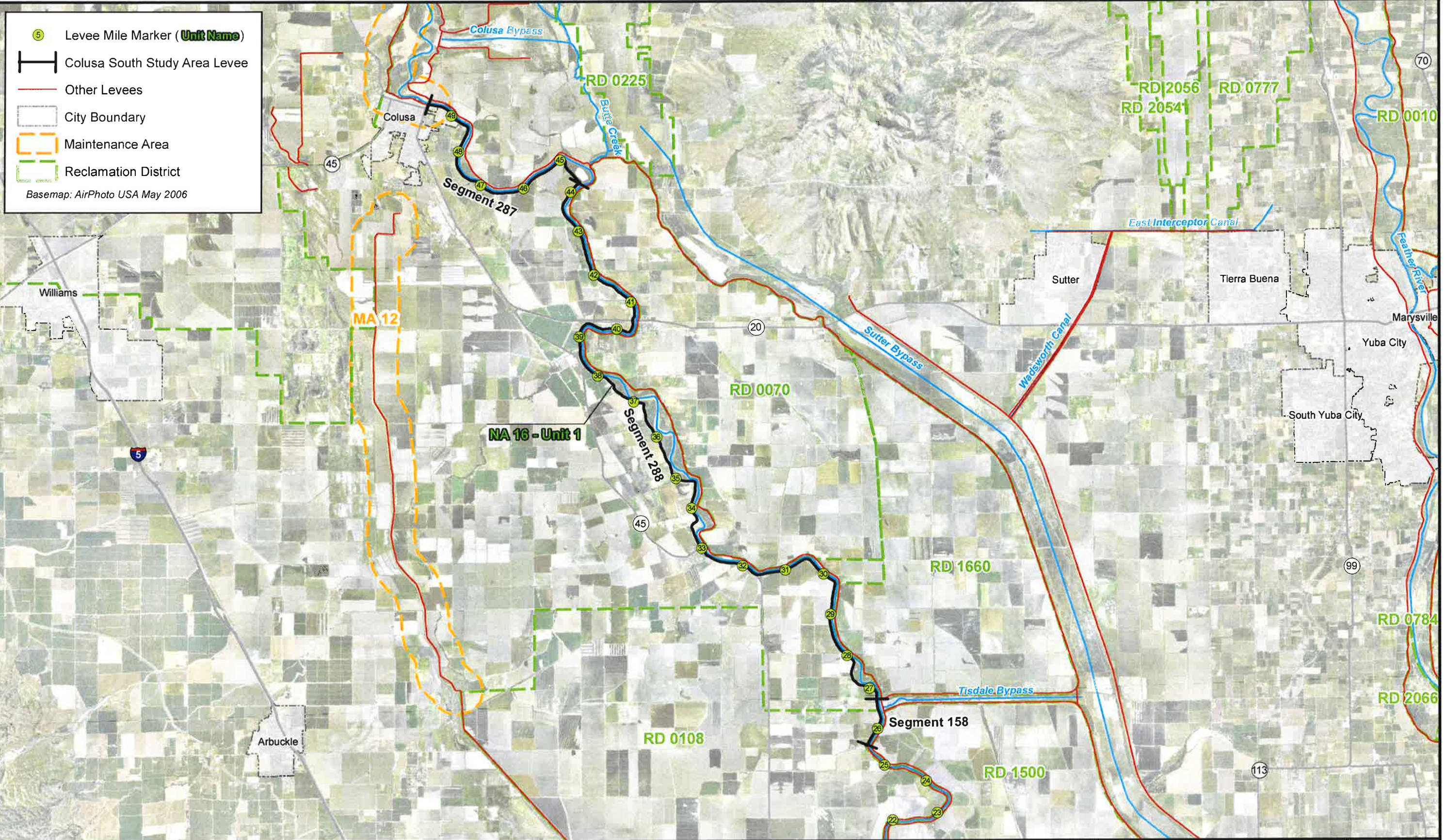

5 Levee Mile Marker (**Unit Name**)
 Colusa South Study Area Levee
 Other Levees
 City Boundary
 Maintenance Area
 Reclamation District
 Basemap: AirPhoto USA May 2006

L:\Projects\DWRI\GEOTECHNICAL\Non_Urban\GORTOC_NN\LE_GOR\Figures\Colusa\South\VOL1\MXD\NCASGORV1F_STAL1_4.mxd AMN 07.18.2014 SAC

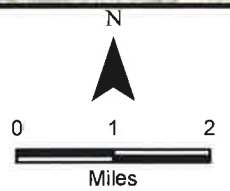

Department of Water Resources
 Division of Flood Management

URS
 in association with:
GEI

Colusa South
 Study Area Levees
 NON-URBAN LEVEE EVALUATIONS

Figure
1-4

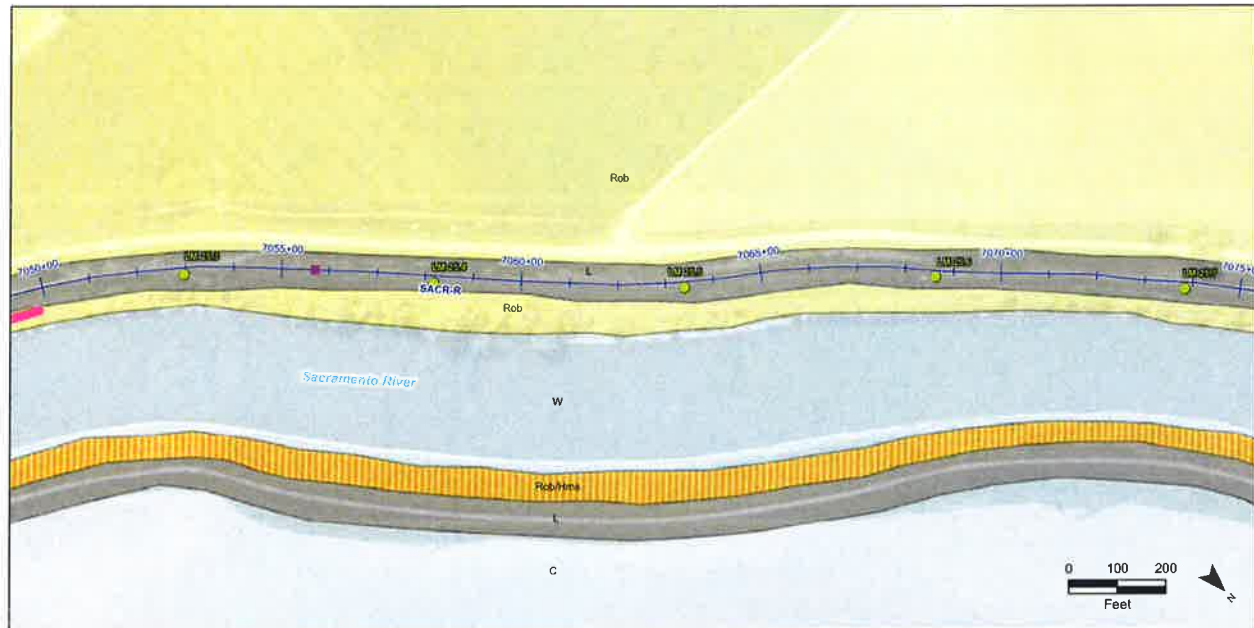

- NOTES:
1. These plan and profile drawings support the Geotechnical Overview Report and are not intended for any other use or purpose. Please see accompanying report for details.
 2. Elevations of levee crest and landside toe are approximate. Levee crest elevations are from the California Levee Database (CLD) levee centerline and landside toe elevations are based on DWR-provided LIDAR data.
 3. The assessment water surface elevations are based on information provided by DWR.
 4. Where water was present in the ditch at the time LIDAR was flown, the ditch bottom elevation is the water surface elevation. For analyses purposes, the bottom elevation of the ditch was calculated based on a depth of water estimated from available data.
 5. Locations of explorations are approximate. Stick logs represent general soil conditions encountered at the time of exploration. For more detailed information on the materials encountered, refer to boring and CPT logs in the Geotechnical Data Report for the NULE Colusa South study area. No warranty is provided regarding the continuity of soil conditions between individual explorations.
 6. When reported, N_{60} (ASTM) = N field * (Hammer Efficiency(%)/60). See Geotechnical Data Report for the NULE Colusa South study area for hammer efficiency data for individual borings.
 7. USCS classification labels are not presented on the stick logs for soil layers less than 1.5 feet thick or historical borings with limited data.
 8. This is a color figure. Black and white reproduction should not be relied upon as data will be lost.
 9. To prevent scale distortion, this map should be printed on an ANSI "D" size sheet (22x34 inches).
 10. Where past performance and mitigation line features are geographically coincident, symbols have been offset for display purposes.
 11. Surficial geology was mapped at 1:24,000 scale. (Source: Level 2-II Geomorphic Assessment and Surficial Mapping of the Sacramento River below Colusa and Adjoining Areas for NULE Project, URS, 2010).
 12. The information provided on these plates has been compiled from a variety of sources. The URS team does not attest to the accuracy, completeness, or reliability of plan or subsurface data (including geotechnical exploration) by others that are included or referenced in these plates.
 13. These plan and profile drawings are for the use and benefit of DWR, and their consultants in connection with the execution of the NULE Colusa South study area. Use by any other party is at their own discretion and risk. These figures should not be used as the sole basis for design, construction, remedial action, or major capital spending decisions.

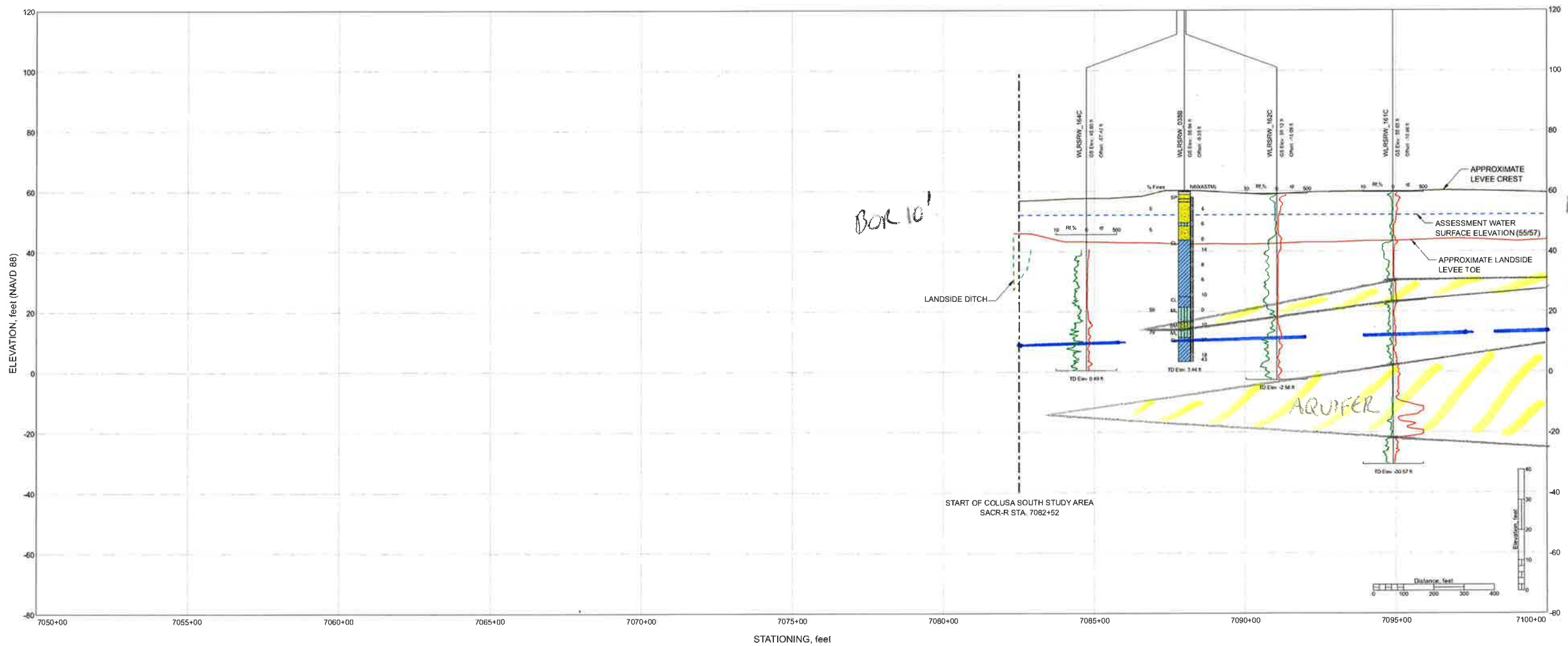

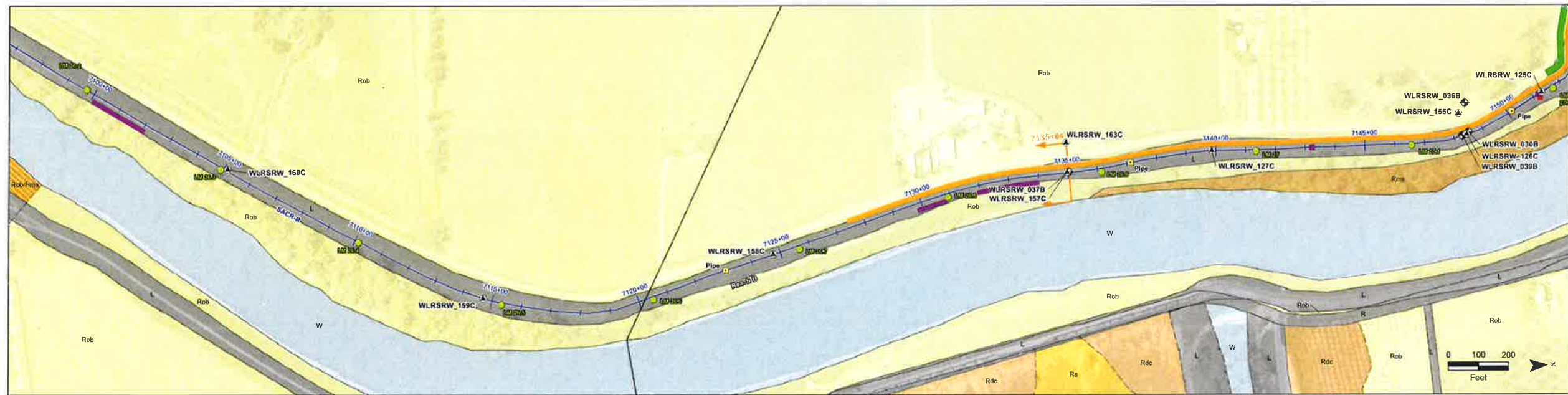

- NOTES**
1. These plan and profile drawings support the Geotechnical Overview Report and are not intended for any other use or purpose. Please see accompanying report for details.
 2. Elevations of levee crest and landside toe are approximate. Levee crest elevations are from the California Levee Database (CLD) levee centerline and landside toe elevations are based DWR-provided LIDAR data.
 3. The assessment water surface elevations are based on information provided by DWR.
 4. Where water was present in the ditch at the time LIDAR was flown, the ditch bottom elevation is the water surface elevation. For analyses purposes, the bottom elevation of the ditch was calculated based on a depth of water estimated from available data.
 5. Locations of explorations are approximate. Stick logs represent general soil conditions encountered at the time of exploration. For more detailed information on the materials encountered, refer to boring and CPT logs in the Geotechnical Data Report for the NULE Colusa South study area. No warranty is provided regarding the continuity of soil conditions between individual explorations.
 6. When reported, N_e (ASTM) = N field * [Hammer Efficiency(%)/60]. See Geotechnical Data Report for the NULE Colusa South study area for hammer efficiency data for individual borings.
 7. USCS classification labels are not presented on the stick logs for soil layers less than 1.5 feet thick or historical borings with limited data.
 8. This is a color figure. Black and white reproduction should not be relied upon as data will be lost.
 9. To prevent scale distortion, this map should be printed on an ANSI "D" size sheet (22x34 inches).
 10. Where past performance and mitigation line features are geographically coincident, symbols have been offset for display purposes.
 11. Surficial geology was mapped at 1:24,000 scale. (Source: Level 2-II Geomorphic Assessment and Surficial Mapping of the Sacramento River below Colusa and Adjoining Areas for NULE Project, URS, 2010).
 12. The information provided on these plates has been compiled from a variety of sources. The URS team does not attest to the accuracy, completeness, or reliability of plan or subsurface data (including geotechnical exploration) by others that are included or referenced in these plates.
 13. These plan and profile drawings are for the use and benefit of DWR, and their consultants in connection with the execution of the NULE Colusa South study area. Use by any other party is at their own discretion and risk. These figures should not be used as the sole basis for design, construction, remedial action, or major capital spending decisions.

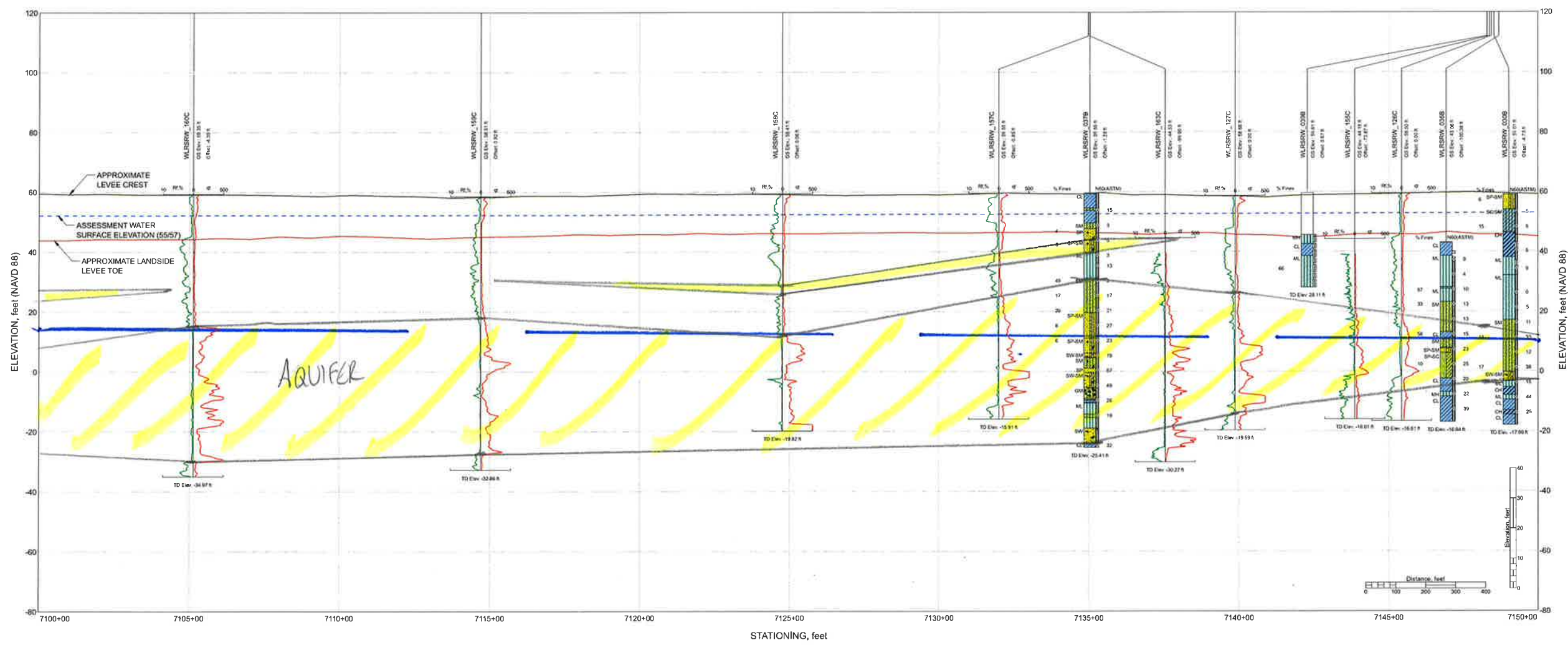

Box 14'

Box 10'

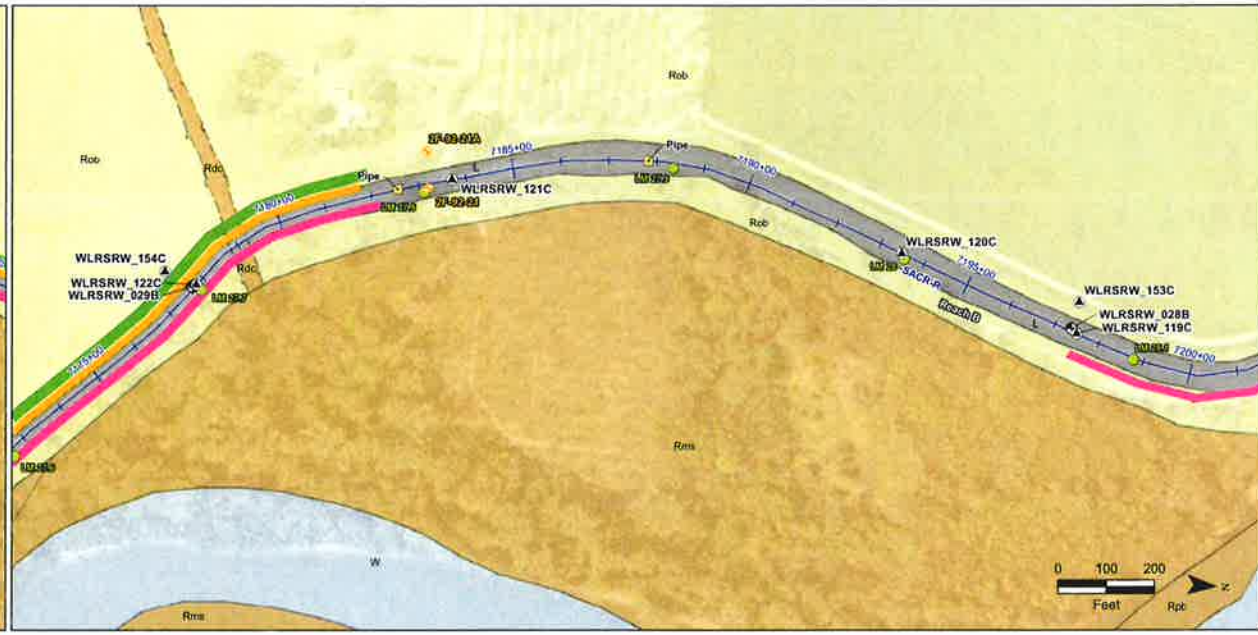
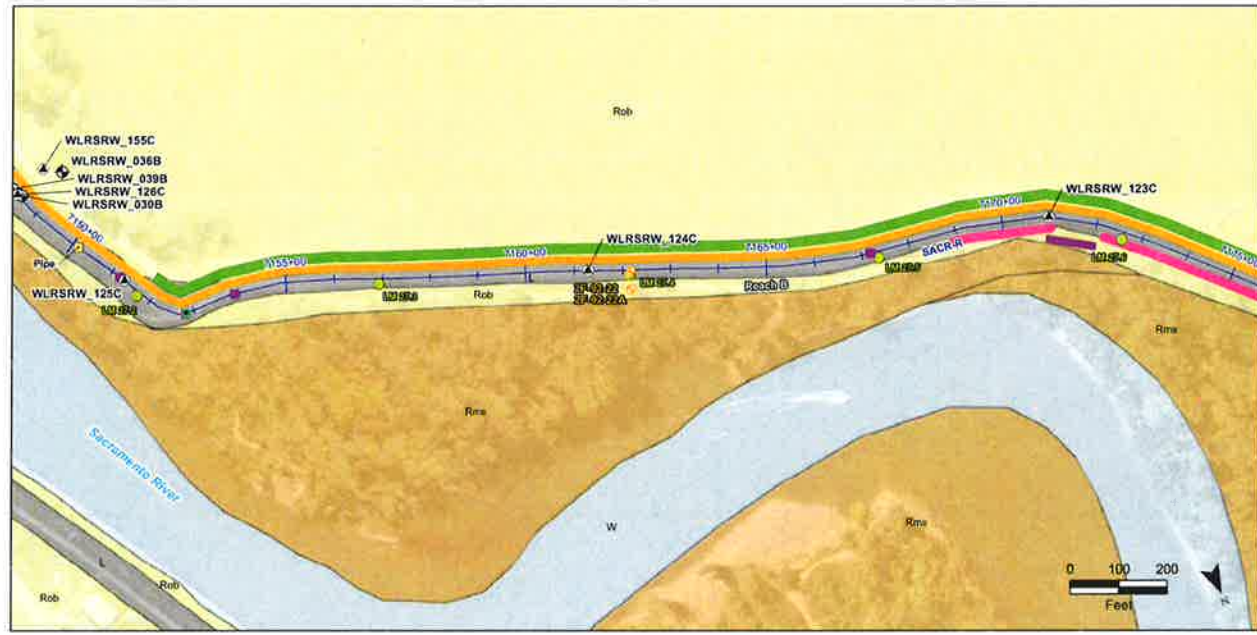

- NOTES:**
1. These plan and profile drawings support the Geotechnical Overview Report and are not intended for any other use or purpose. Please see accompanying report for details.
 2. Elevations of levee crest and landside toe are approximate. Levee crest elevations are from the California Levee Database (CLD) levee centerline and landside toe elevations are based on DWR-provided LIDAR data.
 3. The assessment water surface elevations are based on information provided by DWR.
 4. Where water was present in the ditch at the time LIDAR was flown, the ditch bottom elevation is the water surface elevation. For analysis purposes, the bottom elevation of the ditch was calculated based on a depth of water estimated from available data.
 5. Locations of explorations are approximate. Stick logs represent general soil conditions encountered at the time of exploration. For more detailed information on the materials encountered, refer to boring and CPT logs in the Geotechnical Data Report for the NULE Colusa South study area. No warranty is provided regarding the continuity of soil conditions between individual explorations.
 6. When reported, N_{60} (ASTM) = N field * [Hammer Efficiency(%)/60]. See Geotechnical Data Report for the NULE Colusa South study area for hammer efficiency data for individual borings.
 7. USCS classification labels are not presented on the stick logs for soil layers less than 1.5 feet thick or historical borings with limited data.
 8. This is a color figure. Black and white reproduction should not be relied upon as data will be lost.
 9. To prevent scale distortion, this map should be printed on an ANSI "D" size sheet (22x34 inches).
 10. Where past performance and mitigation line features are geographically coincident, symbols have been offset for display purposes.
 11. Surficial geology was mapped at 1:24,000 scale (Source: Level 2-II Geomorphic Assessment and Surficial Mapping of the Sacramento River below Colusa and Adjoining Areas for NULE Project, URS, 2010).
 12. The information provided on these plates has been compiled from a variety of sources. The URS team does not attest to the accuracy, completeness, or reliability of plan or subsurface data (including geotechnical exploration) by others that are included or referenced in these plates.
 13. These plan and profile drawings are for the use and benefit of DWR, and their consultants in connection with the execution of the NULE Colusa South study area. Use by any other party is at their own discretion and risk. These figures should not be used as the sole basis for design, construction, remedial action, or major capital spending decisions.

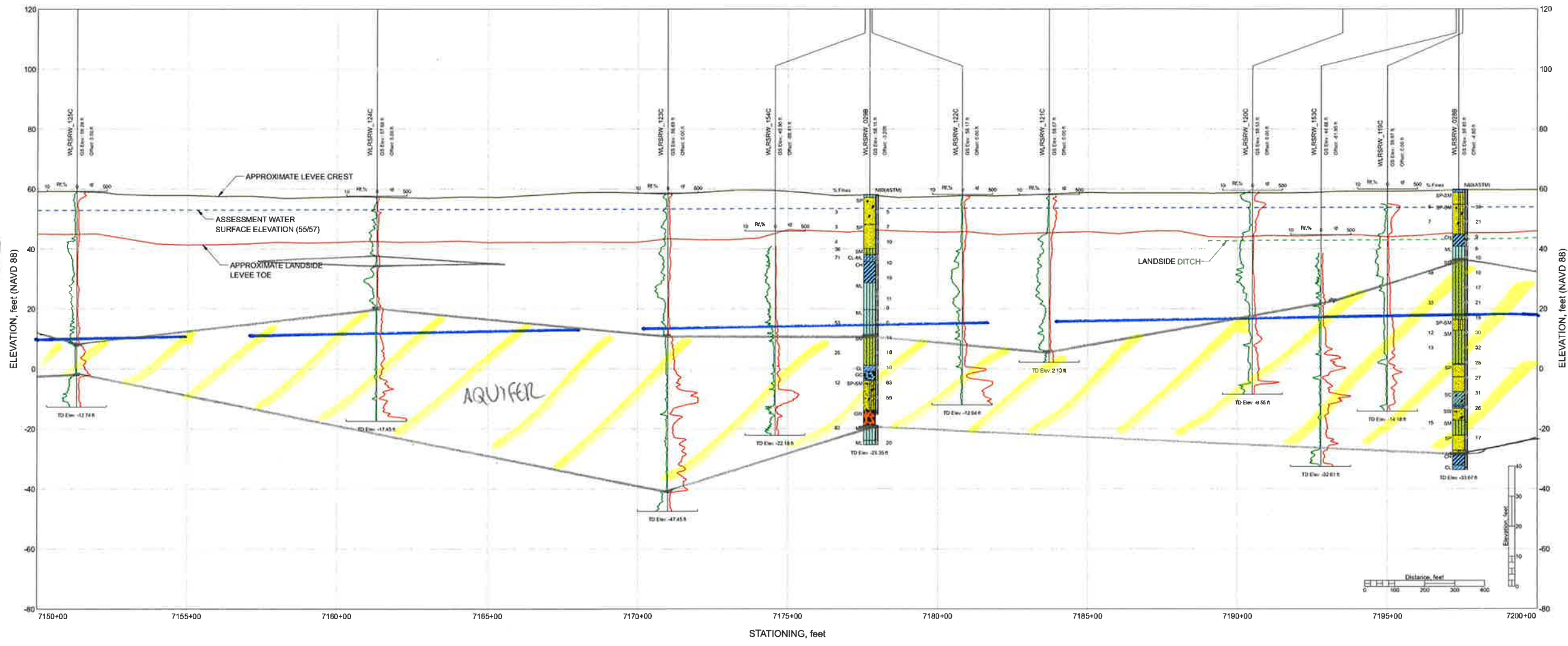

60x10'

60x18'



- NOTES:
1. These plan and profile drawings support the Geotechnical Overview Report and are not intended for any other use or purpose. Please see accompanying report for details.
 2. Elevations of levee crest and landside toe are approximate. Levee crest elevations are from the California Levee Database (CLD) levee centerline and landside toe elevations are based on DWR-provided LIDAR data.
 3. The assessment water surface elevations are based on information provided by DWR.
 4. Where water was present in the ditch at the time LIDAR was flown, the ditch bottom elevation is the water surface elevation. For analysis purposes, the bottom elevation of the ditch was calculated based on a depth of water estimated from available data.
 5. Locations of explorations are approximate. Stick logs represent general soil conditions encountered at the time of exploration. For more detailed information on the materials encountered, refer to boring and CPT logs in the Geotechnical Data Report for the NULE Colusa South study area. No warranty is provided regarding the continuity of soil conditions between individual explorations.
 6. When reported, N_{60} (ASTM) = N (ft) * [Hammer Efficiency(%)/60]. See Geotechnical Data Report for the NULE Colusa South study area for hammer efficiency data for individual borings.
 7. USCS classification labels are not presented on the stick logs for soil layers less than 1.5 feet thick or historical borings with limited data.
 8. This is a color figure. Black and white reproduction should not be relied upon as data will be lost.
 9. To prevent scale distortion, this map should be printed on an ANSI "D" size sheet (22x34 inches).
 10. Where past performance and mitigation line features are geographically coincident, symbols have been offset for display purposes.
 11. Surficial geology was mapped at 1:24,000 scale. (Source: Level 2-II Geomorphic Assessment and Surficial Mapping of the Sacramento River below Colusa and Adjoining Areas for NULE Project, URS, 2010).
 12. The information provided on these plates has been compiled from a variety of sources. The URS team does not attest to the accuracy, completeness, or reliability of plan or subsurface data (including geotechnical exploration) by others that are included or referenced in these plates.
 13. These plan and profile drawings are for the use and benefit of DWR, and their consultants in connection with the execution of the NULE Colusa South study area. Use by any other party is at their own discretion and risk. These figures should not be used as the sole basis for design, construction, remedial action, or major capital spending decisions.

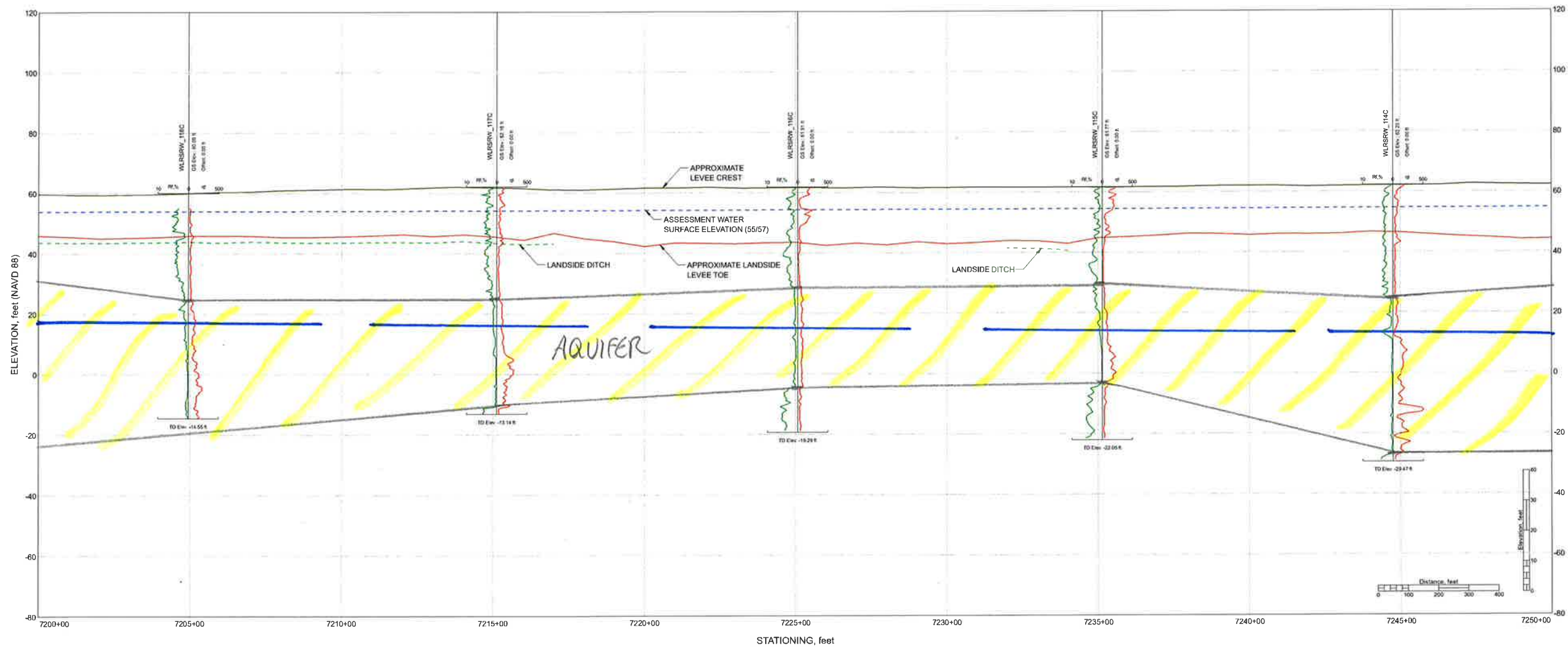

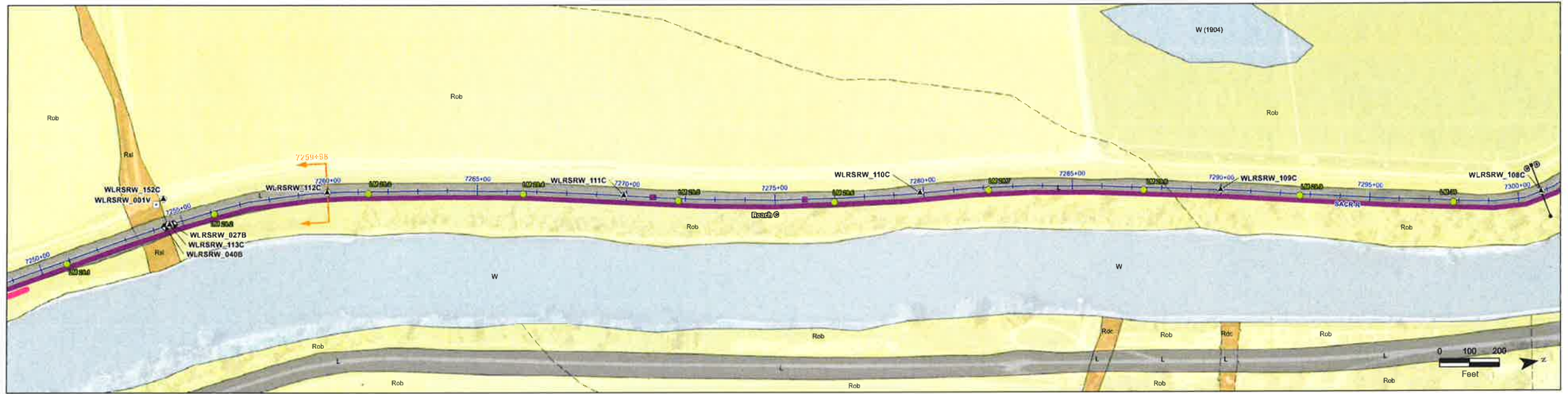

- NOTES:**
1. These plan and profile drawings support the Geotechnical Overview Report and are not intended for any other use or purpose. Please see accompanying report for details.
 2. Elevations of levee crest and landside toe are approximate. Levee crest elevations are from the California Levee Database (CLD) levee centerline and landside toe elevations are based on DWR-provided LIDAR data.
 3. The assessment water surface elevations are based on information provided by DWR.
 4. Where water was present in the ditch at the time LIDAR was flown, the ditch bottom elevation is the water surface elevation. For analysis purposes, the bottom elevation of the ditch was calculated based on a depth of water estimated from available data.
 5. Locations of explorations are approximate. Slick logs represent general soil conditions encountered at the time of exploration. For more detailed information on the materials encountered, refer to boring and CPT logs in the Geotechnical Data Report for the NULE Colusa South study area. No warranty is provided regarding the continuity of soil conditions between individual explorations.
 6. When reported, N_{60} (ASTM = N field) [Hammer Efficiency (%)/60]. See Geotechnical Data Report for the NULE Colusa South study area for hammer efficiency data for individual borings.
 7. USCS classification labels are not presented on the slick logs for soil layers less than 1.5 feet thick or historical borings with limited data.
 8. This is a color figure. Black and white reproduction should not be relied upon as data will be lost.
 9. To prevent scale distortion, this map should be printed on an ANSI "D" size sheet (22x34 inches).
 10. Where past performance and mitigation line features are geographically coincident, symbols have been offset for display purposes.
 11. Surficial geology was mapped at 1:24,000 scale. (Source: Level 2-II Geomorphic Assessment and Surficial Mapping of the Sacramento River below Colusa and Adjoining Areas for NULE Project, URS, 2010).
 12. The information provided on these plates has been compiled from a variety of sources. The URS team does not warrant the accuracy, completeness, or reliability of plan or subsurface data (including geotechnical exploration) by others that are included or referenced in these plates.
 13. These plan and profile drawings are for the use and benefit of DWR, and their consultants in connection with the execution of the NULE Colusa South study area. Use by any other party is at their own discretion and risk. These figures should not be used as the sole basis for design, construction, remedial action, or major capital spending decisions.

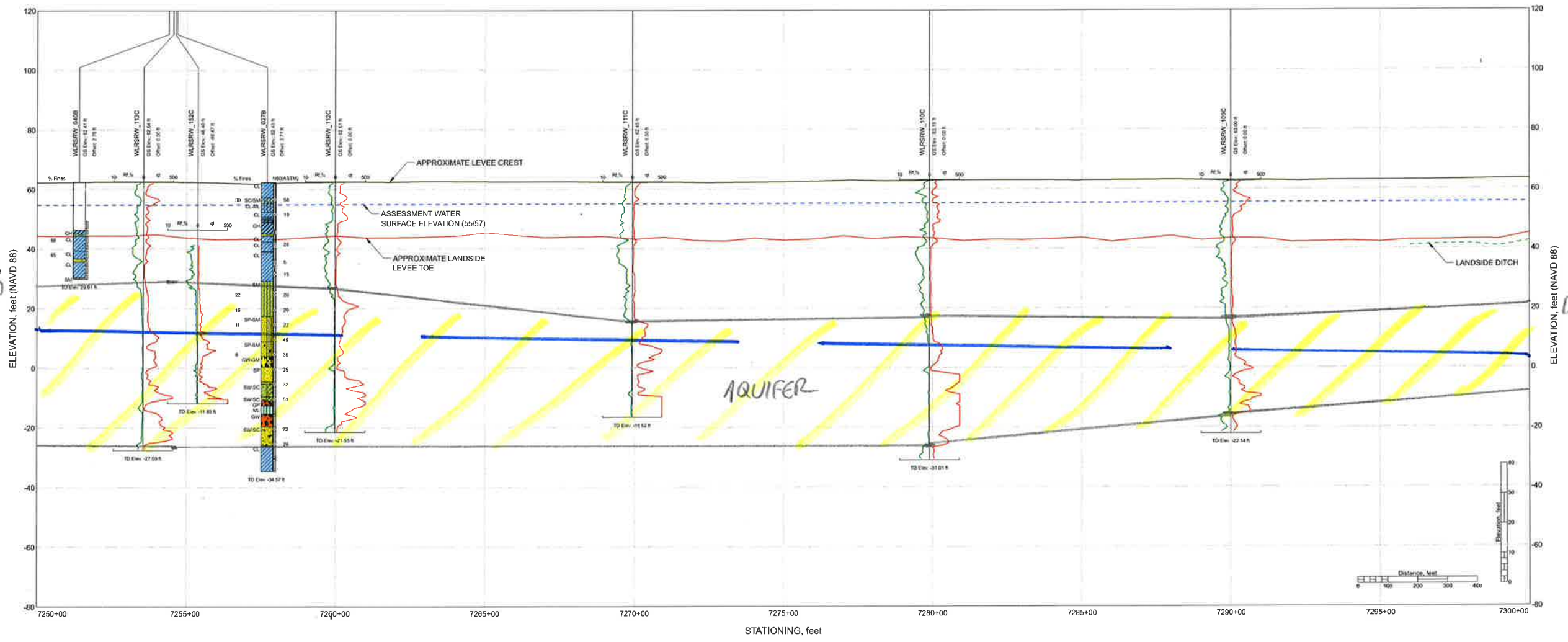

BOUL'S

BOUL'S

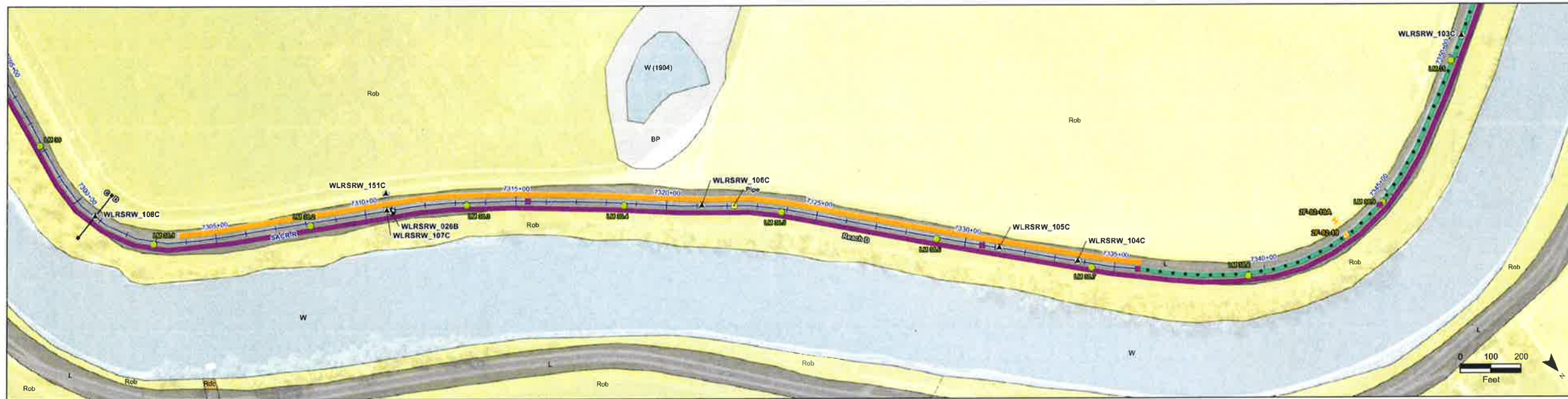

- NOTES:
1. These plan and profile drawings support the Geotechnical Overview Report and are not intended for any other use or purpose. Please see accompanying report for details.
 2. Elevations of levee crest and landside toe are approximate. Levee crest elevations are from the California Levee Database (CLD) levee centerline and landside toe elevations are based DWR-provided LIDAR data.
 3. The assessment water surface elevations are based on information provided by DWR.
 4. Where water was present in the ditch at the time LIDAR was flown, the ditch bottom elevation is the water surface elevation. For analyses purposes, the bottom elevation of the ditch was calculated based on a depth of water estimated from available data.
 5. Locations of explorations are approximate. Stick logs represent general soil conditions encountered at the time of exploration. For more detailed information on the materials encountered, refer to boring and CPT logs in the Geotechnical Data Report for the NULE Colusa South study area. No warranty is provided regarding the continuity of soil conditions between individual explorations.
 6. When reported, N_{60} (ASTM) = N field * [Hammer Efficiency(%)/60]. See Geotechnical Data Report for the NULE Colusa South study area for hammer efficiency data for individual borings.
 7. USCS classification labels are not presented on the stick logs for soil layers less than 1.5 feet thick or historical borings with limited data.
 8. This is a color figure. Black and white reproduction should not be relied upon as data will be lost.
 9. To prevent scale distortion, this map should be printed on an ANSI "D" size sheet (22x34 inches).
 10. Where past performance and mitigation line features are geographically coincident, symbols have been offset for display purposes.
 11. Surficial geology was mapped at 1:24,000 scale. (Source: Level 2-II Geomorphic Assessment and Surficial Mapping of the Sacramento River below Colusa and Adjoining Areas for NULE Project, URS, 2010).
 12. The information provided on these plates has been compiled from a variety of sources. The URS team does not attest to the accuracy, completeness, or reliability of plan or subsurface data (including geotechnical exploration) by others that are included or referenced in these plates.
 13. These plan and profile drawings are for the use and benefit of DWR, and their consultants in connection with the execution of the NULE Colusa South study area. Use by any other party is at their own discretion and risk. These figures should not be used as the sole basis for design, construction, remedial action, or major capital spending decisions.

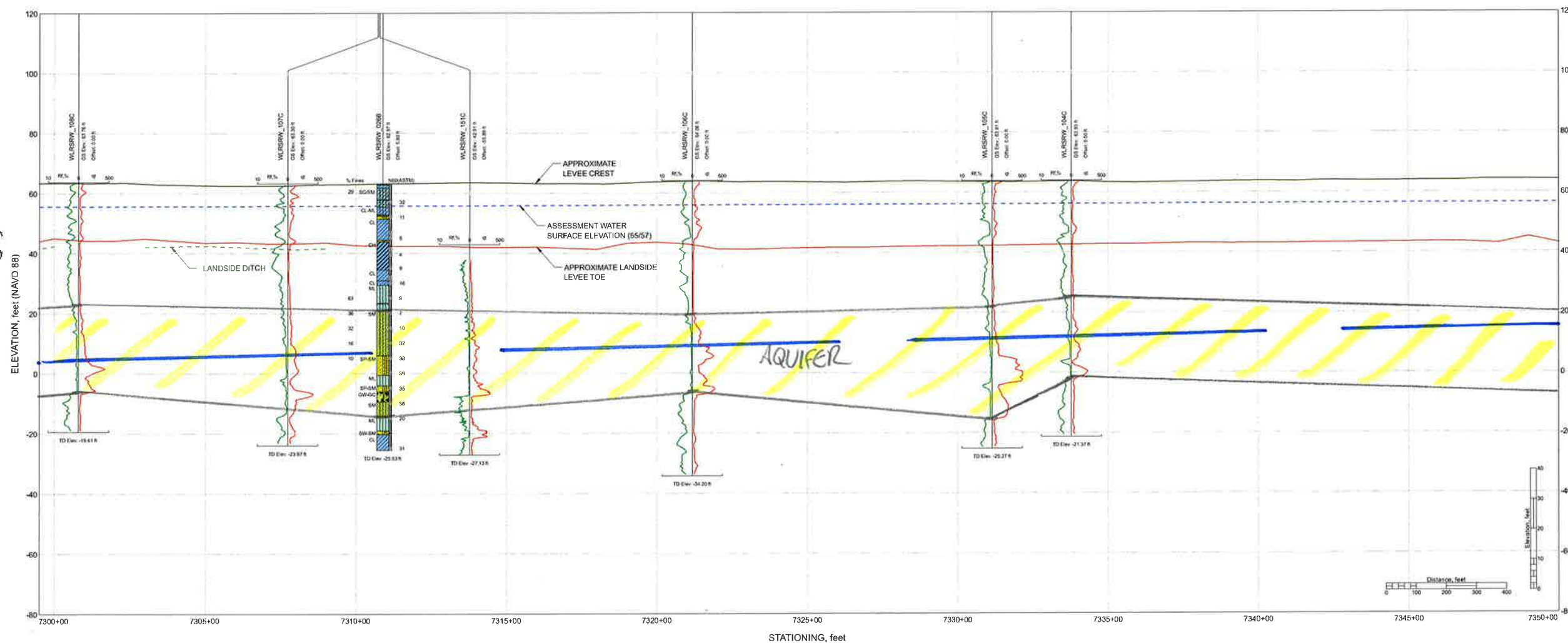

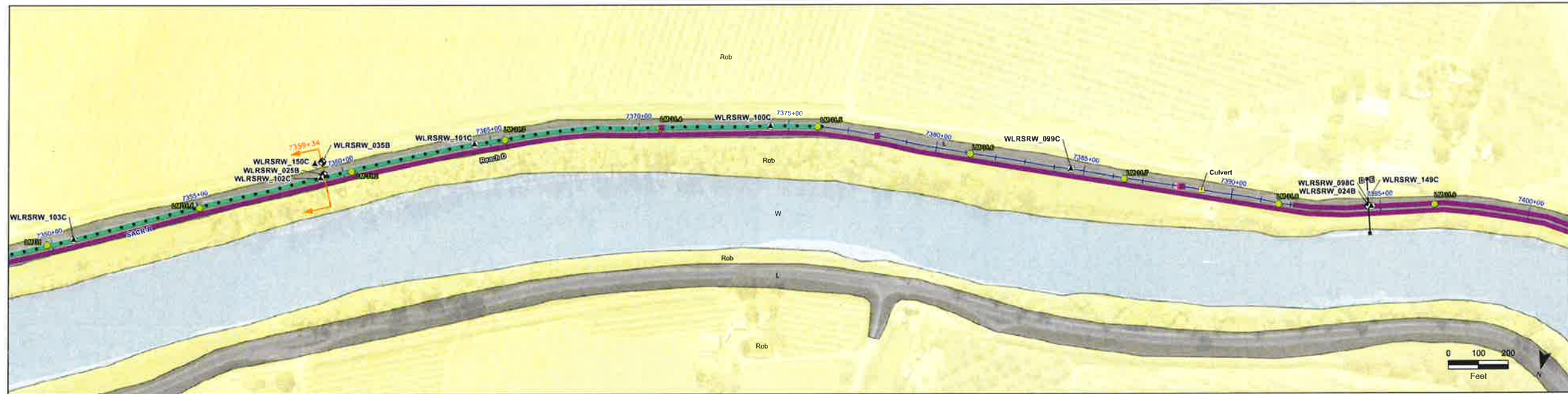

- NOTES:**
1. These plan and profile drawings support the Geotechnical Overview Report and are not intended for any other use or purpose. Please see accompanying report for details.
 2. Elevations of levee crest and landside toe are approximate. Levee crest elevations are from the California Levee Database (CLD) levee centerline and landside toe elevations are based DWR-provided LIDAR data.
 3. The assessment water surface elevations are based on information provided by DWR.
 4. Where water was present in the ditch at the time LIDAR was flown, the ditch bottom elevation is the water surface elevation. For analyses purposes, the bottom elevation of the ditch was calculated based on a depth of water estimated from available data.
 5. Locations of explorations are approximate. Slick logs represent general soil conditions encountered at the time of exploration. For more detailed information on the materials encountered, refer to boring and CPT logs in the Geotechnical Data Report for the NULE Colusa South study area. No warranty is provided regarding the continuity of soil conditions between individual explorations.
 6. When reported, N_{60} (ASTM) = N field * [Hammer Efficiency(%)/60]. See Geotechnical Data Report for the NULE Colusa South study area for hammer efficiency data for individual borings.
 7. USCS classification labels are not presented on the slick logs for soil layers less than 1.5 feet thick or historical borings with limited data.
 8. This is a color figure. Black and white reproduction should not be relied upon as data will be lost.
 9. To prevent scale distortion, this map should be printed on an ANSI "D" size sheet (22x34 inches).
 10. Where past performance and mitigation line features are geographically coincident, symbols have been offset for display purposes.
 11. Surficial geology was mapped at 1:24,000 scale. (Source: Level 2-II Geomorphic Assessment and Surficial Mapping of the Sacramento River below Colusa and Adjoining Areas for NULE Project, URS, 2010).
 12. The information provided on these plates has been compiled from a variety of sources. The URS team does not attest to the accuracy, completeness, or reliability of plan or subsurface data (including geotechnical exploration) by others that are included or referenced in these plates.
 13. These plan and profile drawings are for the use and benefit of DWR, and their consultants in connection with the execution of the NULE Colusa South study area. Use by any other party is at their own discretion and risk. These figures should not be used as the sole basis for design, construction, remediation, or major capital spending decisions.

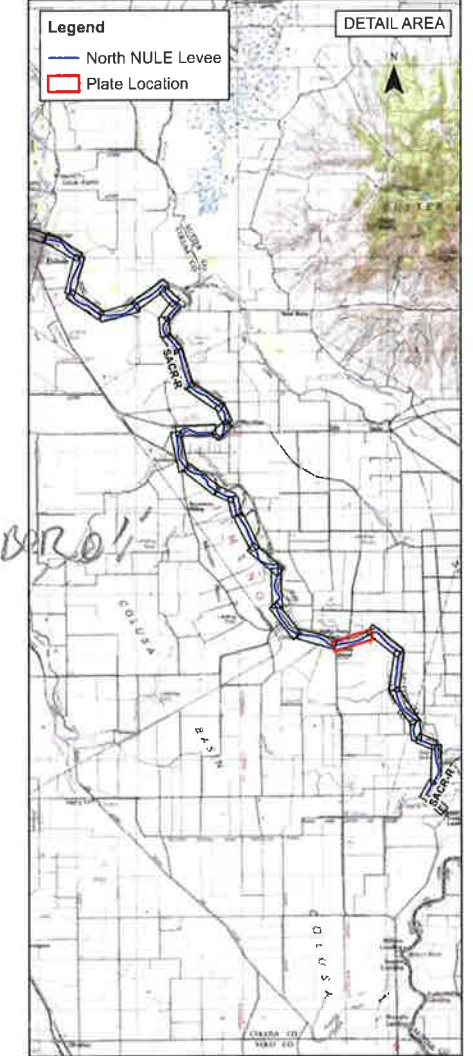
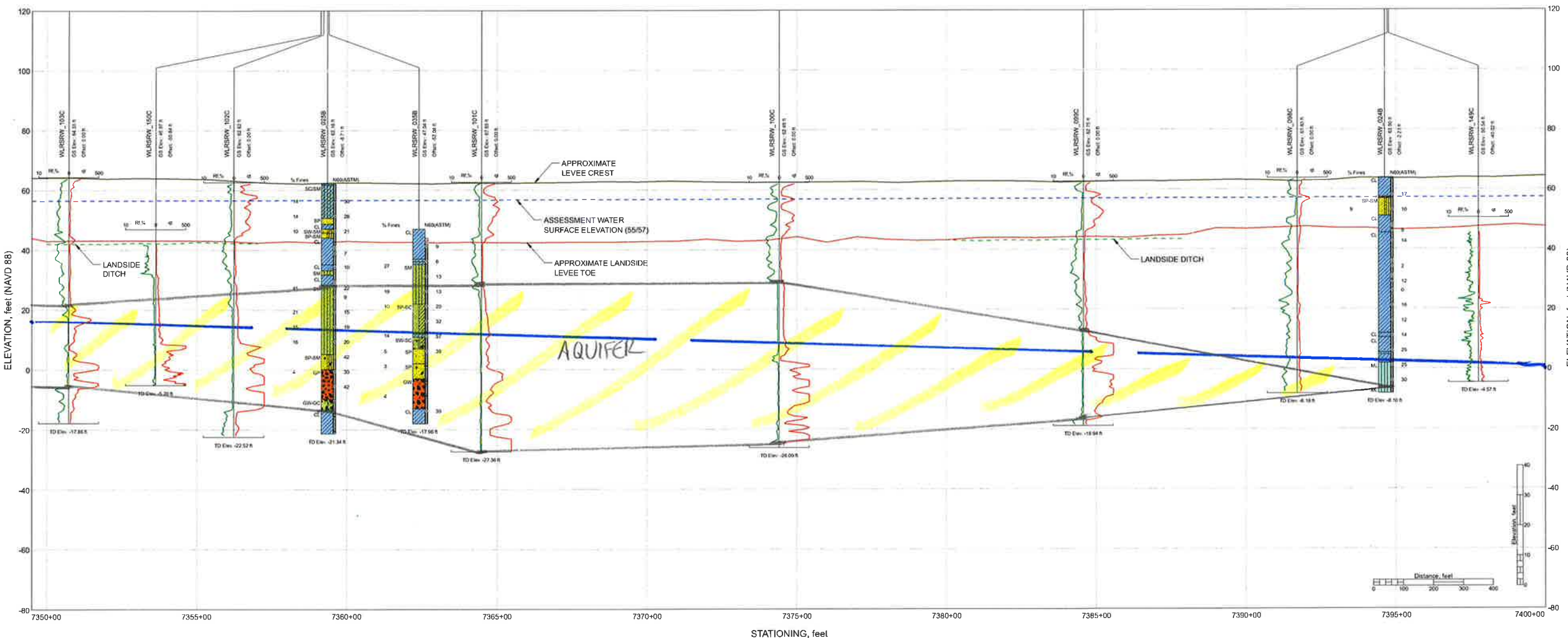

Box 17

Box 17

11/20/2013 2:40pm 02/08/14 NULE Colusa South Study Area

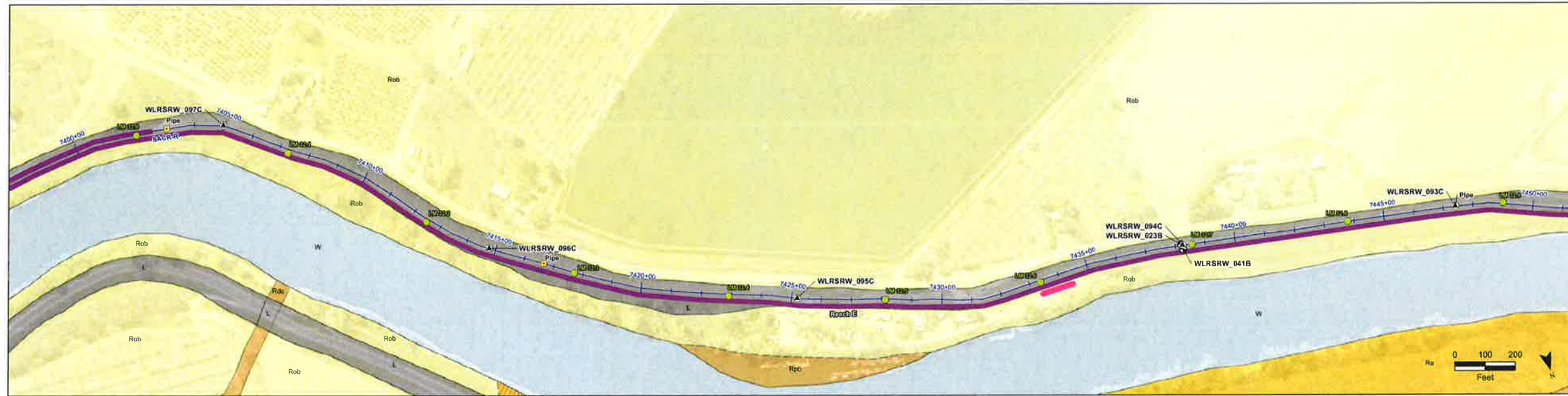

- NOTES:
1. These plan and profile drawings support the Geotechnical Overview Report and are not intended for any other use or purpose. Please see accompanying report for details.
 2. Elevations of levee crest and landside toe are approximate. Levee crest elevations are from the California Levee Database (CLD) levee centerline and landside toe elevations are based DWR-provided LIDAR data.
 3. The assessment water surface elevations are based on information provided by DWR.
 4. Where water was present in the ditch at the time LIDAR was flown, the ditch bottom elevation is the water surface elevation. For analyses purposes, the bottom elevation of the ditch was calculated based on a depth of water estimated from available data.
 5. Locations of explorations are approximate. Stick logs represent general soil conditions encountered at the time of exploration. For more detailed information on the materials encountered, refer to boring and CPT logs in the Geotechnical Data Report for the NULE Colusa South study area. No warranty is provided regarding the continuity of soil conditions between individual explorations.
 6. When reported, N_u (ASTM) = N field * [Hammer Efficiency(%)/60]. See Geotechnical Data Report for the NULE Colusa South study area for hammer efficiency data for individual borings.
 7. USCS classification labels are not presented on the stick logs for soil layers less than 1.5 feet thick or historical borings with limited data.
 8. This is a color figure. Black and white reproduction should not be relied upon as data will be lost.
 9. To prevent scale distortion, this map should be printed on an ANSI "D" size sheet (22x34 inches).
 10. Where past performance and mitigation line features are geographically coincident, symbols have been offset for display purposes.
 11. Surficial geology was mapped at 1:24,000 scale. (Source: Level 2-II Geomorphic Assessment and Surficial Mapping of the Sacramento River below Colusa and Adjoining Areas for NULE Project, URS, 2010).
 12. The information provided on these plates has been compiled from a variety of sources. The URS team does not attest to the accuracy, completeness, or reliability of plan or subsurface data (including geotechnical exploration) by others that are included or referenced in these plates.
 13. These plan and profile drawings are for the use and benefit of DWR, and their consultants in connection with the execution of the NULE Colusa South study area. Use by any other party is at their own discretion and risk. These figures should not be used as the sole basis for design, construction, remedial action, or major capital spending decisions.

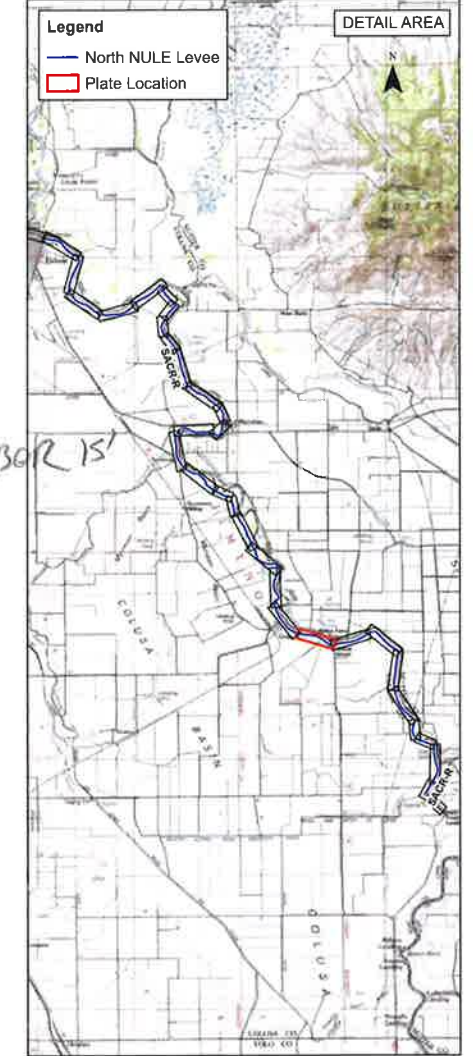
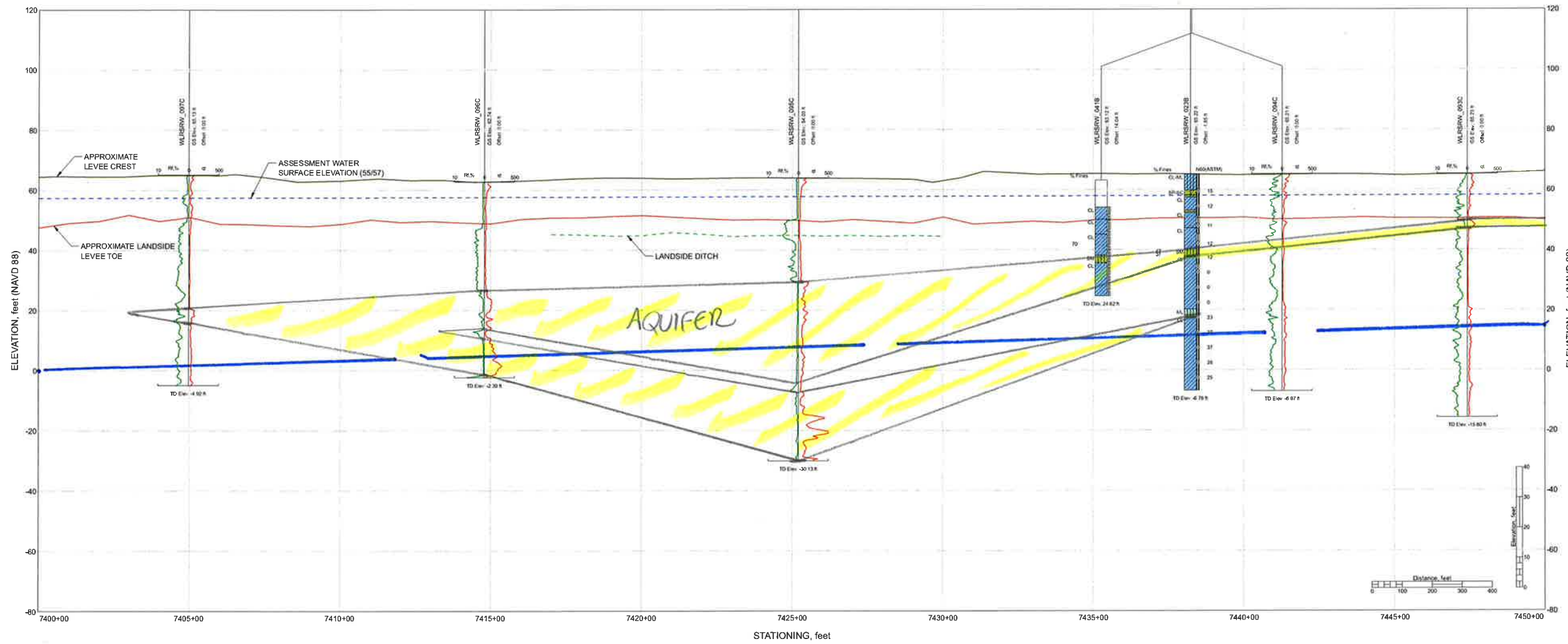

BORO

BORO 15'

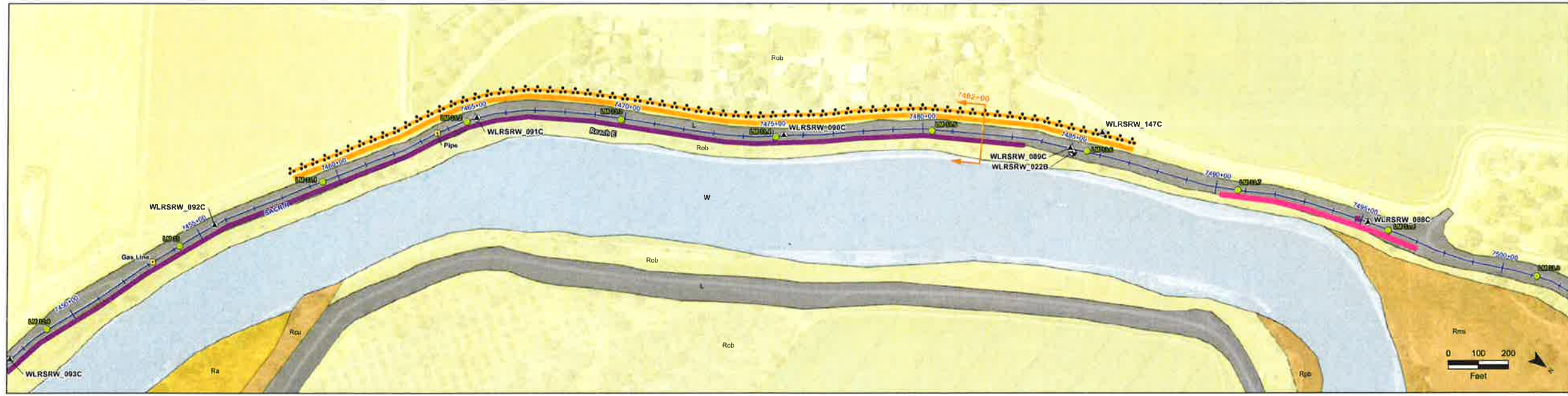

- NOTES:**
1. These plan and profile drawings support the Geotechnical Overview Report and are not intended for any other use or purpose. Please see accompanying report for details.
 2. Elevations of levee crest and landside toe are approximate. Levee crest elevations are from the California Levee Database (CLD) levee centerline and landside toe elevations are based DWR-provided LIDAR data.
 3. The assessment water surface elevations are based on information provided by DWR.
 4. Where water was present in the ditch at the time LIDAR was flown, the ditch bottom elevation is the water surface elevation. For analyses purposes, the bottom elevation of the ditch was calculated based on a depth of water estimated from available data.
 5. Locations of explorations are approximate. Stick logs represent general soil conditions encountered at the time of exploration. For more detailed information on the materials encountered, refer to boring and CPT logs in the Geotechnical Data Report for the NULE Colusa South study area. No warranty is provided regarding the continuity of soil conditions between individual explorations.
 6. When reported, N_{60} (ASTM) = N field * [Hammer Efficiency (%) / 60]. See Geotechnical Data Report for the NULE Colusa South study area for hammer efficiency data for individual borings.
 7. USCS classification labels are not presented on the stick logs for soil layers less than 1.5 feet thick or historical borings with limited data.
 8. This is a color figure. Black and white reproduction should not be relied upon as data will be lost.
 9. To prevent scale distortion, this map should be printed on an ANSI "D" size sheet (22x34 inches).
 10. Where past performance and mitigation line features are geographically coincident, symbols have been offset for display purposes.
 11. Surficial geology was mapped at 1:24,000 scale. (Source: Level 2-B Geomorphic Assessment and Surficial Mapping of the Sacramento River below Colusa and Adjoining Areas for NULE Project, URS, 2010).
 12. The information provided on these plates has been compiled from a variety of sources. The URS team does not attest to the accuracy, completeness, or reliability of plan or subsurface data (including geotechnical exploration) by others that are included or referenced in these plates.
 13. These plan and profile drawings are for the use and benefit of DWR, and their consultants in connection with the execution of the NULE Colusa South study area. Use by any other party is at their own discretion and risk. These figures should not be used as the sole basis for design, construction, remedial action, or major capital spending decisions.

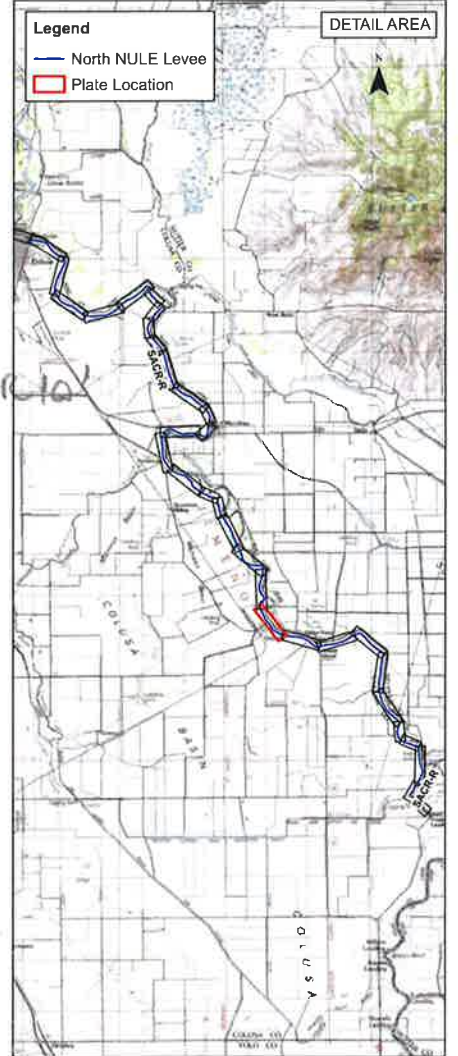
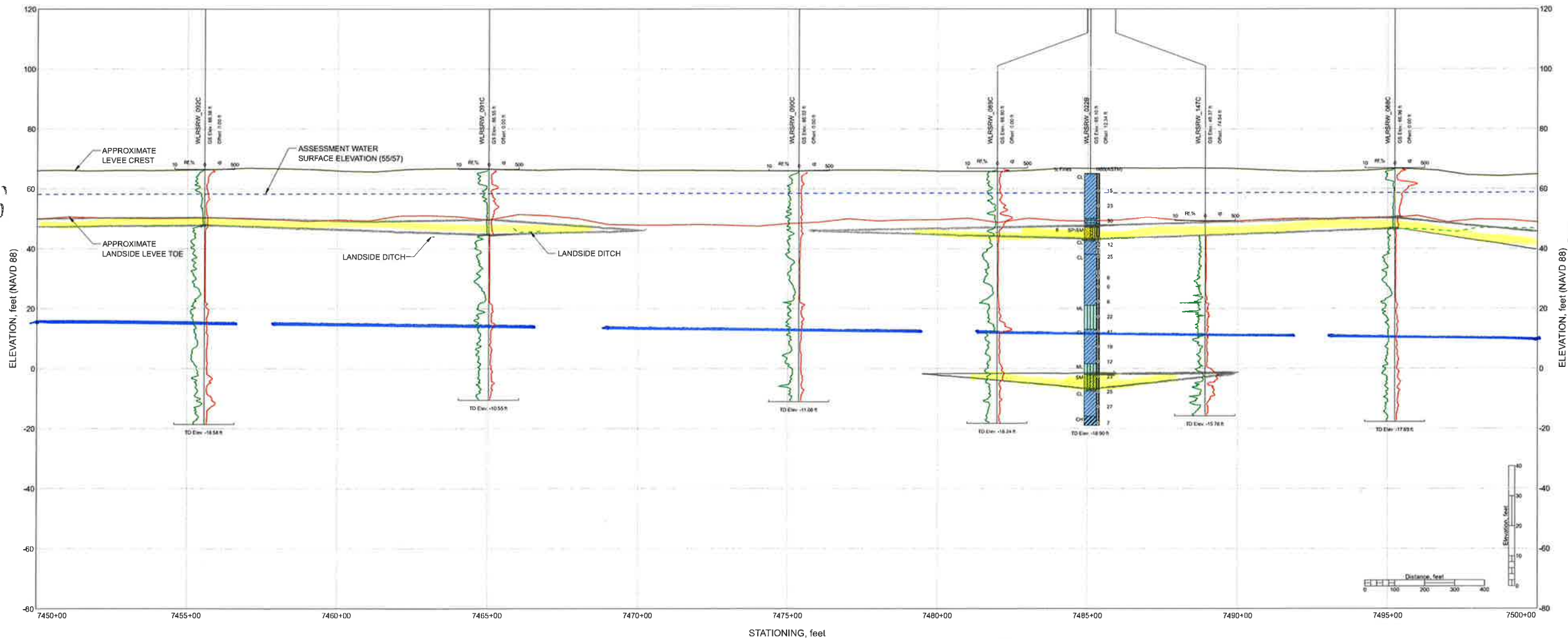

Bor 15'

Bor 10'

11 June 2013, 2:45pm, NULE Colusa South, 11 of 11

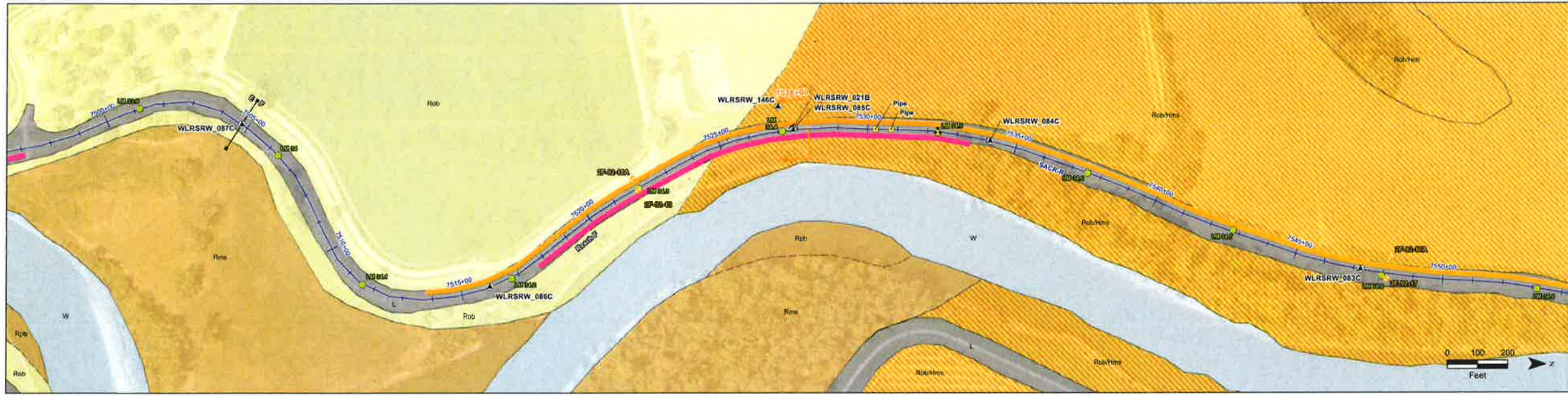

- NOTES:**
1. These plan and profile drawings support the Geotechnical Overview Report and are not intended for any other use or purpose. Please see accompanying report for details.
 2. Elevations of levee crest and landside toe are approximate. Levee crest elevations are from the California Levee Database (CLD) levee centerline and landside toe elevations are based on DWR-provided LIDAR data.
 3. The assessment water surface elevations are based on information provided by DWR.
 4. Where water was present in the ditch at the time LIDAR was flown, the ditch bottom elevation is the water surface elevation. For analyses purposes, the bottom elevation of the ditch was calculated based on a depth of water estimated from available data.
 5. Locations of explorations are approximate. Slick logs represent general soil conditions encountered at the time of exploration. For more detailed information on the materials encountered, refer to boring and CPT logs in the Geotechnical Data Report for the NULE Colusa South study area. No warranty is provided regarding the continuity of soil conditions between individual explorations.
 6. When reported, N_{60} (ASTM) = N field * [Hammer Efficiency(%)/60]. See Geotechnical Data Report for the NULE Colusa South study area for hammer efficiency data for individual borings.
 7. USCS classification labels are not presented on the slick logs for soil layers less than 1.5 feet thick or historical borings with limited data.
 8. This is a color figure. Black and white reproduction should not be relied upon as data will be lost.
 9. To prevent scale distortion, this map should be printed on an ANSI "D" size sheet (22x34 inches).
 10. Where past performance and mitigation line features are geographically coincident, symbols have been offset for display purposes.
 11. Surficial geology was mapped at 1:24,000 scale. (Source: Level 2-II Geomorphic Assessment and Surficial Mapping of the Sacramento River below Colusa and Adjoining Areas for NULE Project, URS, 2010).
 12. The information provided on these plates has been compiled from a variety of sources. The URS team does not attest to the accuracy, completeness, or reliability of plan or subsurface data (including geotechnical exploration) by others that are included or referenced in these plates.
 13. These plan and profile drawings are for the use and benefit of DWR, and their consultants in connection with the execution of the NULE Colusa South study area. Use by any other party is at their own discretion and risk. These figures should not be used as the sole basis for design, construction, remediation, or major capital spending decisions.

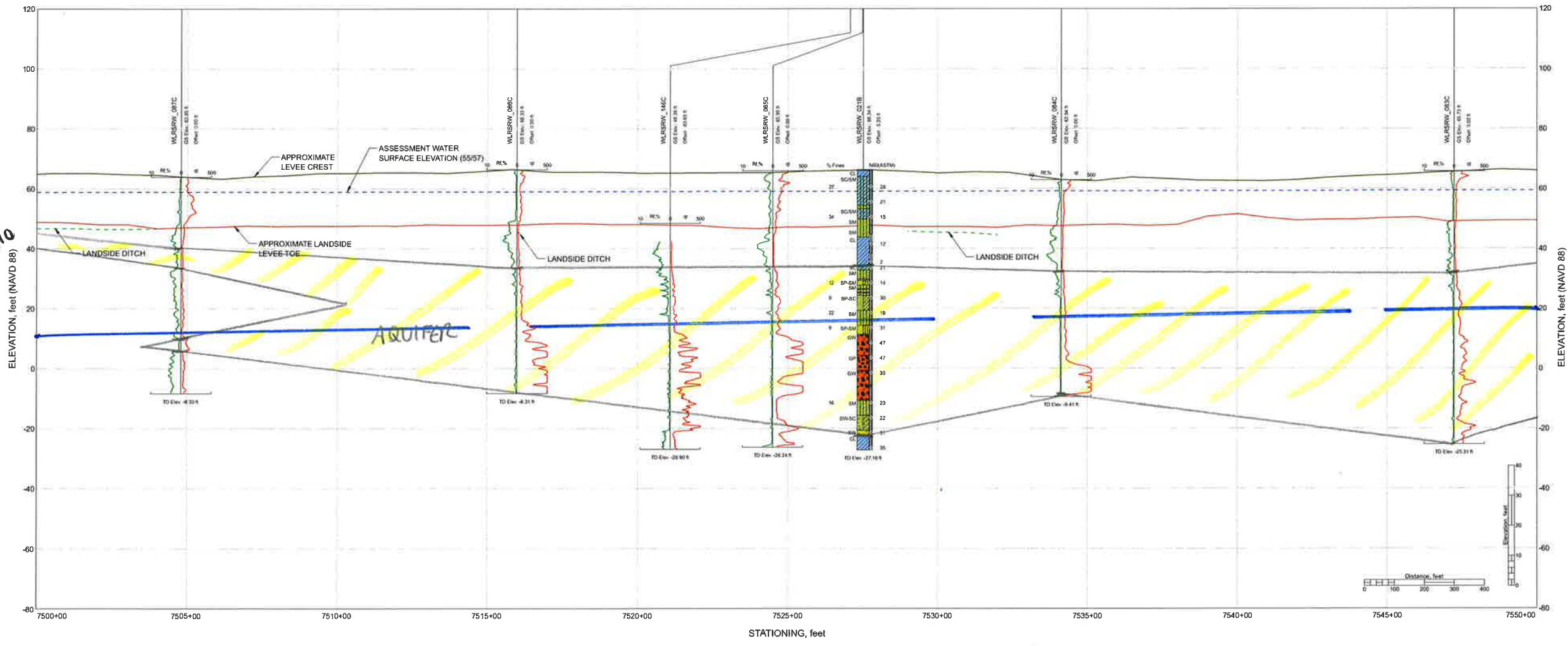

17 June 2013 2:17pm/0212013/NULE/ColusaSouth/0812.dwg

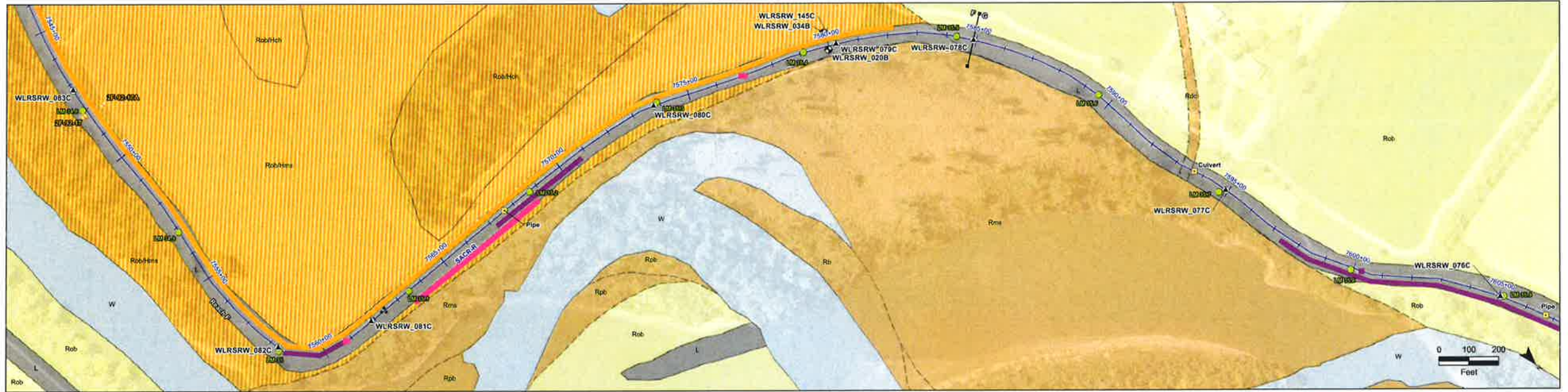

- NOTES:**
1. These plan and profile drawings support the Geotechnical Overview Report and are not intended for any other use or purpose. Please see accompanying report for details.
 2. Elevations of levee crest and landside toe are approximate. Levee crest elevations are from the California Levee Database (CLD) levee centerline and landside toe elevations are based on DWR-provided LIDAR data.
 3. The assessment water surface elevations are based on information provided by DWR.
 4. Where water was present in the ditch at the time LIDAR was flown, the ditch bottom elevation is the water surface elevation. For analysis purposes, the bottom elevation of the ditch was calculated based on a depth of water estimated from available data.
 5. Locations of explorations are approximate. Stick logs represent general soil conditions encountered at the time of exploration. For more detailed information on the materials encountered, refer to boring and CPT logs in the Geotechnical Data Report for the NULE Colusa South study area. No warranty is provided regarding the continuity of soil conditions between individual explorations.
 6. When reported, N_{60} (ASTM) = N field * [Hammer Efficiency (%)/100]. See Geotechnical Data Report for the NULE Colusa South study area for hammer efficiency data for individual borings.
 7. USCS classification labels are not presented on the stick logs for soil layers less than 1.5 feet thick or historical borings with limited data.
 8. This is a color figure. Black and white reproduction should not be relied upon as data will be lost.
 9. To prevent scale distortion, this map should be printed on an ANSI "D" size sheet (22x34 inches).
 10. Where past performance and mitigation line features are geographically coincident, symbols have been offset for display purposes.
 11. Surficial geology was mapped at 1:24,000 scale. (Source: Level 2-II Geomorphic Assessment and Surficial Mapping of the Sacramento River below Colusa and Adjoining Areas for NULE Project, URS, 2010).
 12. The information provided on these plates has been compiled from a variety of sources. The URS team does not warrant the accuracy, completeness, or reliability of plan or subsurface data (including geotechnical exploration) by others that are included or referenced in these plates.
 13. These plan and profile drawings are for the use and benefit of DWR, and their consultants in connection with the execution of the NULE Colusa South study area. Use by any other party is at their own discretion and risk. These figures should not be used as the sole basis for design, construction, remedial action, or major capital spending decisions.

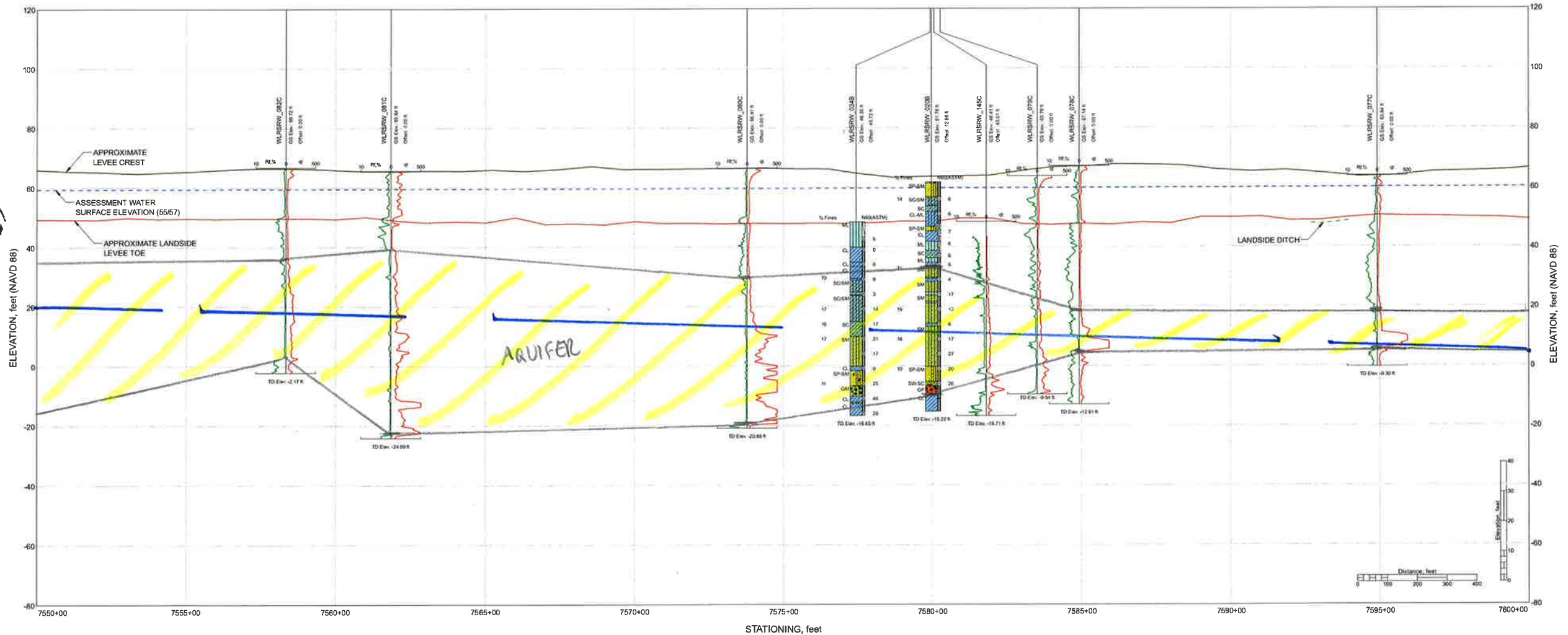

500 to 1

500 to 1

15-Nov-2015 2:48:00 PM 1025123339 1025123339 01.mxd 01

Geotechnical Overview Report

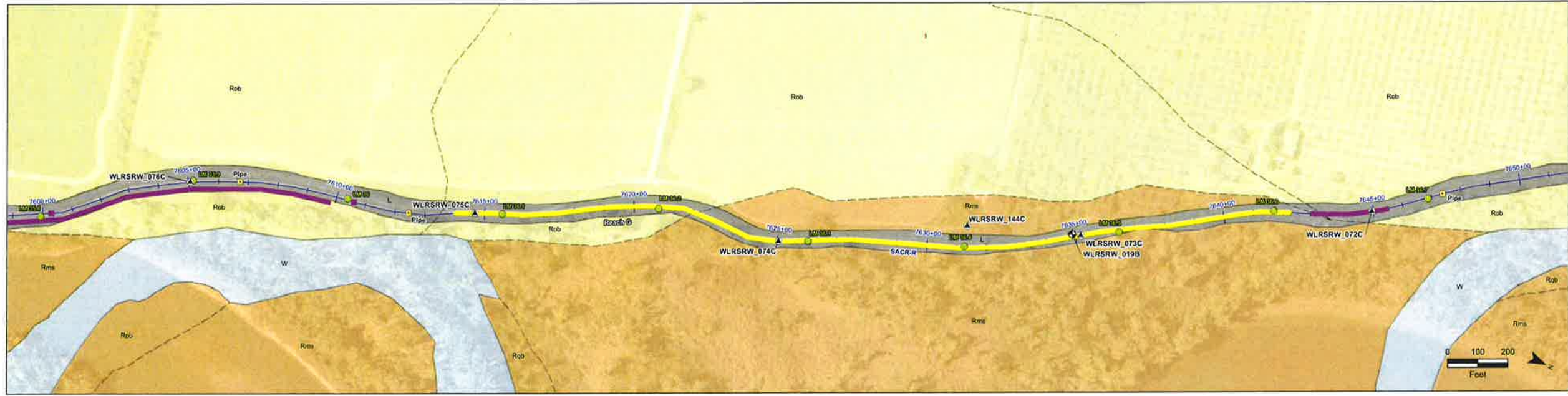

- NOTES:
1. These plan and profile drawings support the Geotechnical Overview Report and are not intended for any other use or purpose. Please see accompanying report for details.
 2. Elevations of levee crest and landside toe are approximate. Levee crest elevations are from the California Levee Database (CLD) levee centerline and landside toe elevations are based DWR-provided LIDAR data.
 3. The assessment water surface elevations are based on information provided by DWR.
 4. Where water was present in the ditch at the time LIDAR was flown, the ditch bottom elevation is the water surface elevation. For analysis purposes, the bottom elevation of the ditch was calculated based on a depth of water estimated from available data.
 5. Locations of explorations are approximate. Stick logs represent general soil conditions encountered at the time of exploration. For more detailed information on the materials encountered, refer to boring and CPT logs in the Geotechnical Data Report for the NULE Colusa South study area. No warranty is provided regarding the continuity of soil conditions between individual explorations.
 6. When reported, N_e (ASTM) = N field * [Hammer Efficiency(%)/60]. See Geotechnical Data Report for the NULE Colusa South study area for hammer efficiency data for individual borings.
 7. USCS classification labels are not presented on the stick logs for soil layers less than 1.5 feet thick or historical borings with limited data.
 8. This is a color figure. Black and white reproduction should not be relied upon as data will be lost.
 9. To prevent scale distortion, this map should be printed on an ANSI "D" size sheet (22x34 inches).
 10. Where past performance and mitigation line features are geographically coincident, symbols have been offset for display purposes.
 11. Surficial geology was mapped at 1:24,000 scale. (Source: Level 2-II Geomorphic Assessment and Surficial Mapping of the Sacramento River below Colusa and Adjoining Areas for NULE Project, URS, 2010).
 12. The information provided on these plates has been compiled from a variety of sources. The URS team does not attest to the accuracy, completeness, or reliability of plan or subsurface data (including geotechnical exploration) by others that are included or referenced in these plates.
 13. These plan and profile drawings are for the use and benefit of DWR, and their consultants in connection with the execution of the NULE Colusa South study area. Use by any other party is at their own discretion and risk. These figures should not be used as the sole basis for design, construction, remedial action, or major capital spending decisions.

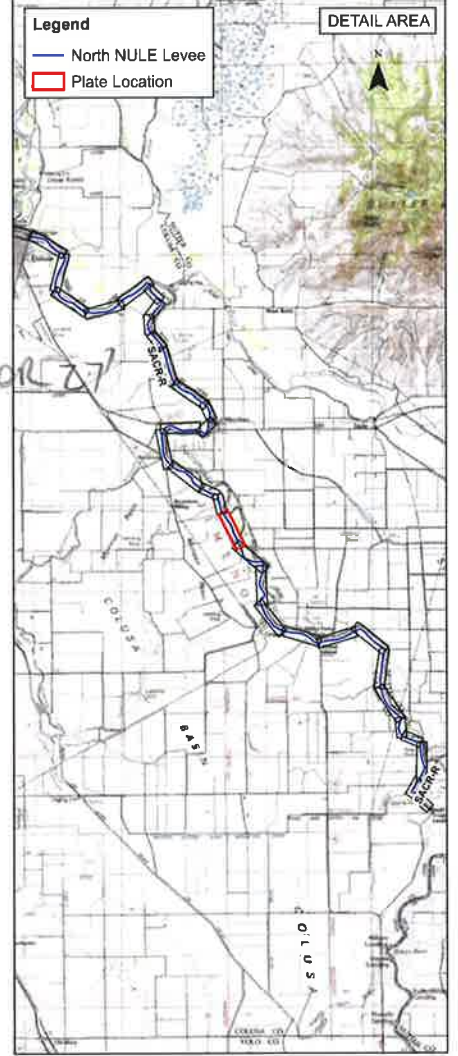
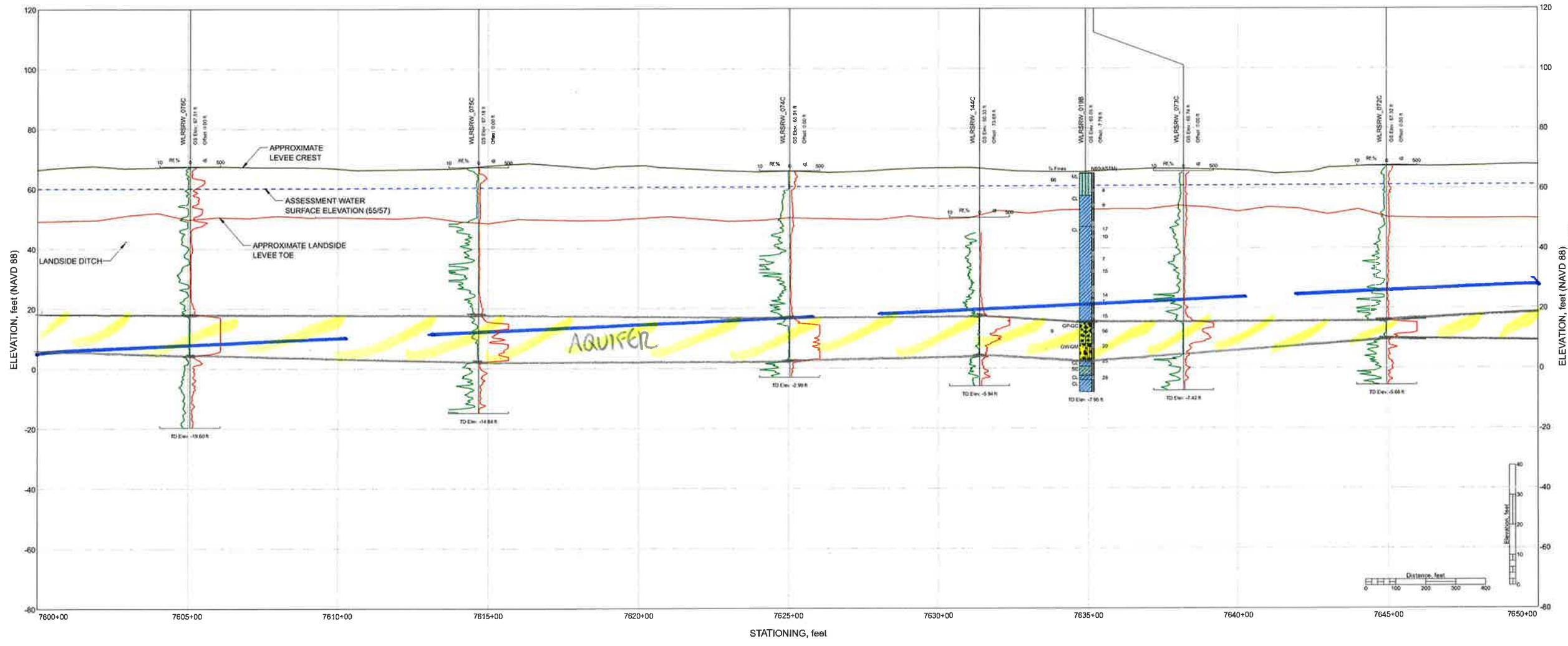

51

BOR 27

14 June 2013 2:40pm 20130614 1411 ColusaSouth 31.mxd 00

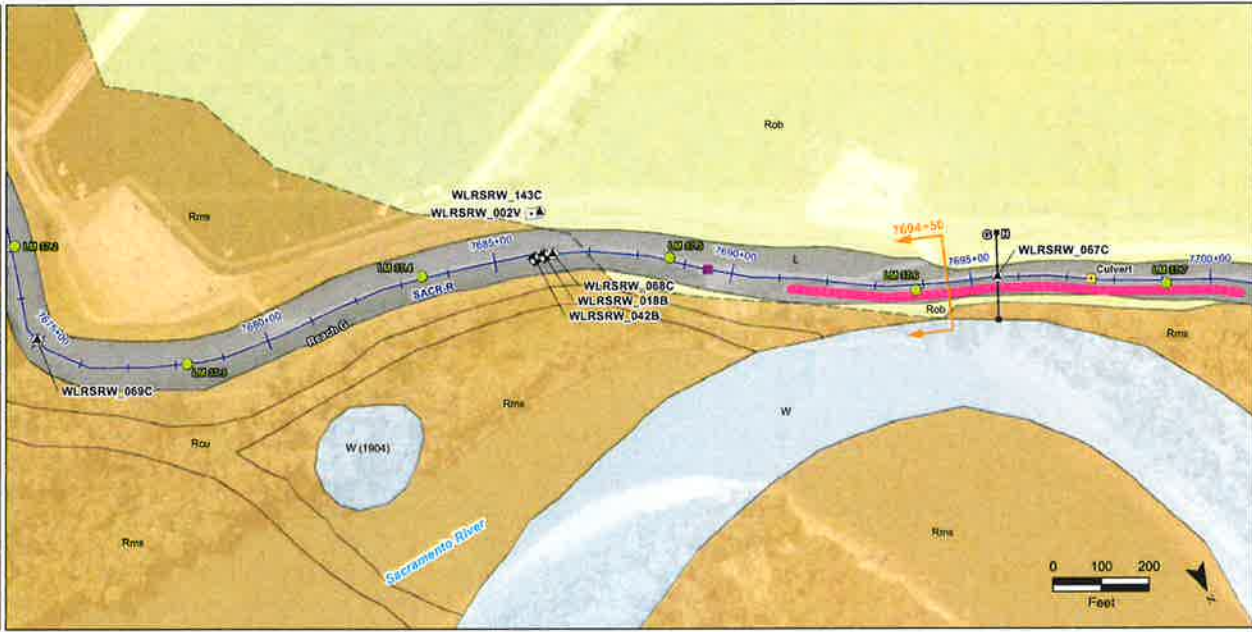
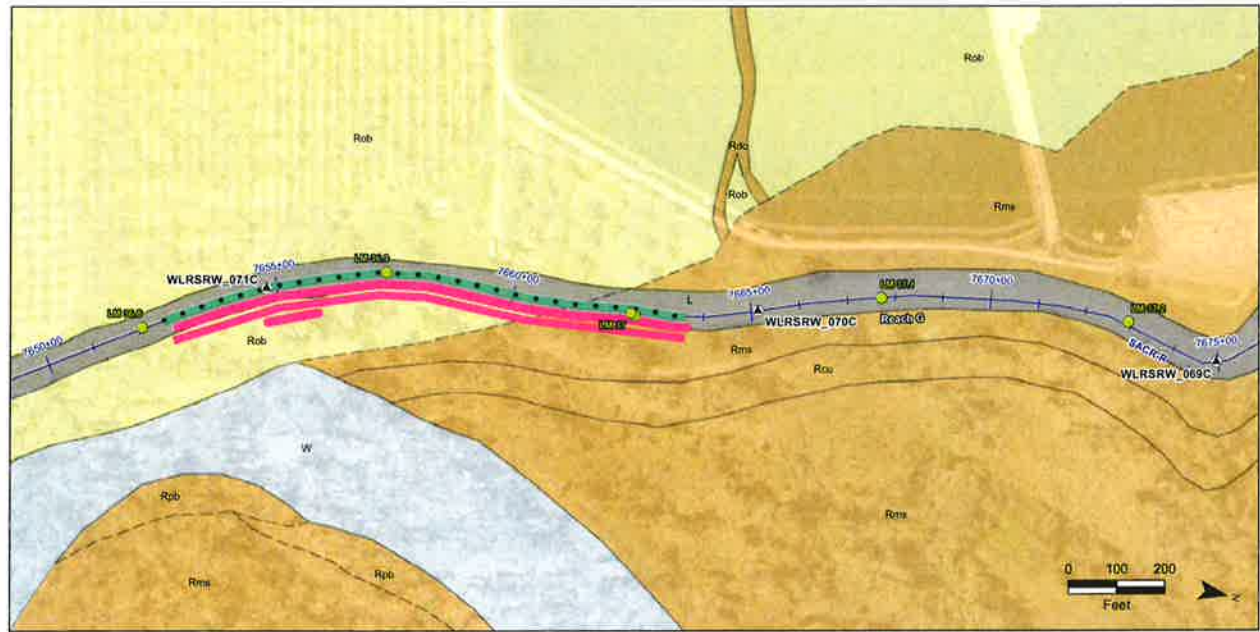

- NOTES:
1. These plan and profile drawings support the Geotechnical Overview Report and are not intended for any other use or purpose. Please see accompanying report for details.
 2. Elevations of levee crest and landside toe are approximate. Levee crest elevations are from the California Levee Database (CLD) levee centerline and landside toe elevations are based on DWR-provided LIDAR data.
 3. The assessment water surface elevations are based on information provided by DWR.
 4. Where water was present in the ditch at the time LIDAR was flown, the ditch bottom elevation is the water surface elevation. For analysis purposes, the bottom elevation of the ditch was calculated based on a depth of water estimated from available data.
 5. Locations of explorations are approximate. Stick logs represent general soil conditions encountered at the time of exploration. For more detailed information on the materials encountered, refer to boring and CPT logs in the Geotechnical Data Report for the NULE Colusa South study area. No warranty is provided regarding the continuity of soil conditions between individual explorations.
 6. When reported, N_e (ASTM) = N field * [Hammer Efficiency (%)/50]. See Geotechnical Data Report for the NULE Colusa South study area for hammer efficiency data for individual borings.
 7. USCS classification labels are not presented on the stick logs for soil layers less than 1.5 feet thick or historical borings with limited data.
 8. This is a color figure. Black and white reproduction should not be relied upon as data will be lost.
 9. To prevent scale distortion, this map should be printed on an ANSI "D" size sheet (22x34 inches).
 10. Where past performance and mitigation line features are geographically coincident, symbols have been offset for display purposes.
 11. Surficial geology was mapped at 1:24,000 scale. (Source: Laval 2-II Geomorphic Assessment and Surficial Mapping of the Sacramento River below Colusa and Adjoining Areas for NULE Project, URS, 2010).
 12. The information provided on these plates has been compiled from a variety of sources. The URS team does not attest to the accuracy, completeness, or reliability of plan or subsurface data (including geotechnical exploration) by others that are included or referenced in these plates.
 13. These plan and profile drawings are for the use and benefit of DWR, and their consultants in connection with the execution of the NULE Colusa South study area. Use by any other party is at their own discretion and risk. These figures should not be used as the sole basis for design, construction, remedial action, or major capital spending decisions.

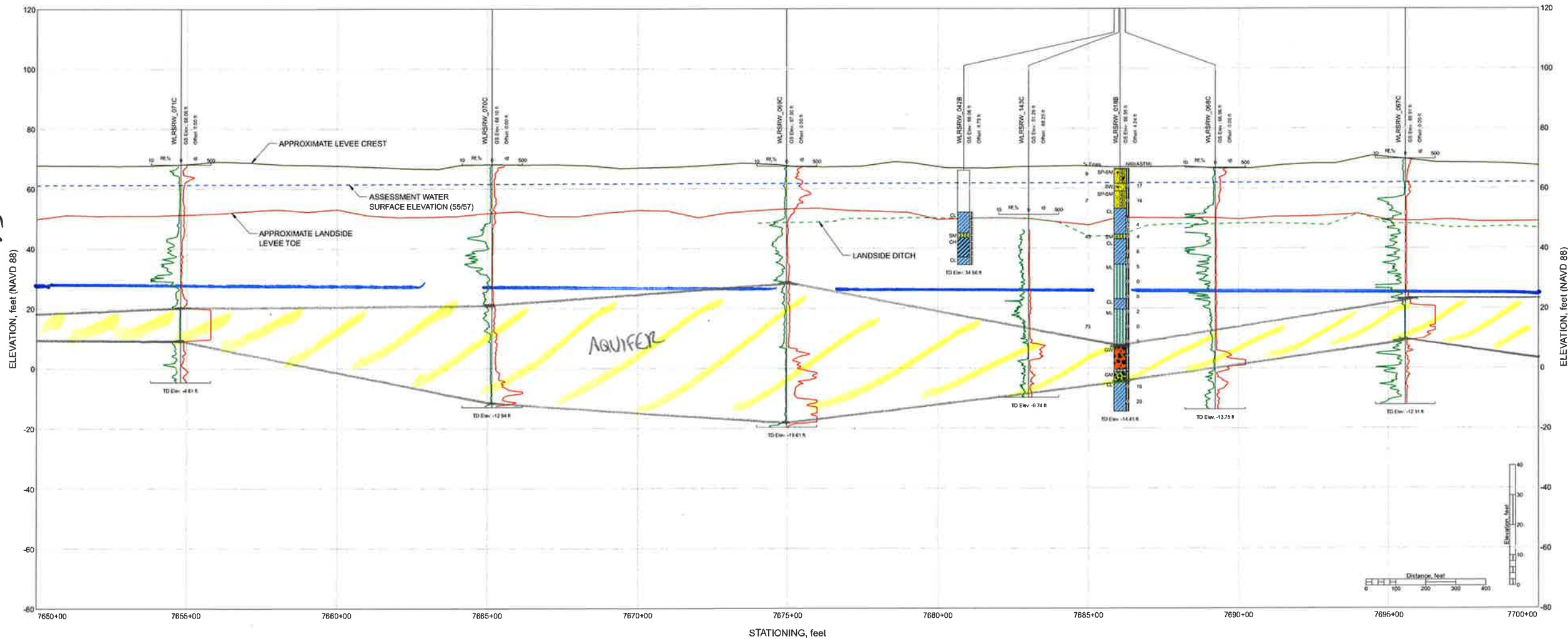

Boyle 17

Boyle 25

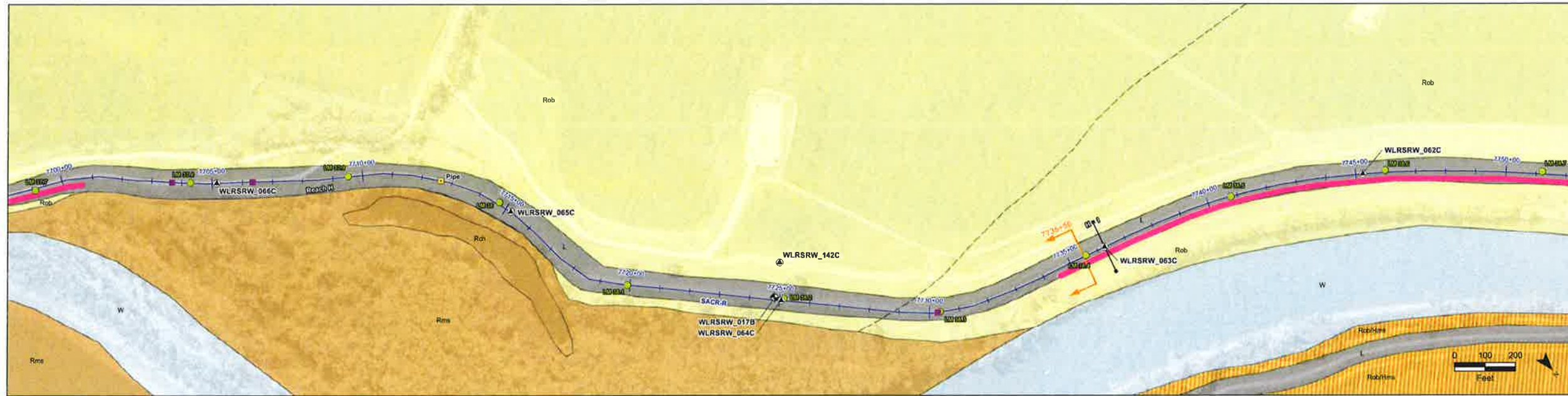

- NOTES:
1. These plan and profile drawings support the Geotechnical Overview Report and are not intended for any other use or purpose. Please see accompanying report for details.
 2. Elevations of levee crest and landside toe are approximate. Levee crest elevations are from the California Levee Database (CLD) levee centerline and landside toe elevations are based on DWR-provided LIDAR data.
 3. The assessment water surface elevations are based on information provided by DWR.
 4. Where water was present in the ditch at the time LIDAR was flown, the ditch bottom elevation is the water surface elevation. For analyses purposes, the bottom elevation of the ditch was calculated based on a depth of water estimated from available data.
 5. Locations of explorations are approximate. Stick logs represent general soil conditions encountered at the time of exploration. For more detailed information on the materials encountered, refer to boring end CPT logs in the Geotechnical Data Report for the NULE Colusa South study area. No warranty is provided regarding the continuity of soil conditions between individual explorations.
 6. When reported, N_e (ASTM) = N field * [Hammer Efficiency(%)/60]. See Geotechnical Data Report for the NULE Colusa South study area for hammer efficiency data for individual borings.
 7. USCS classification labels are not presented on the stick logs for soil layers less than 1.5 feet thick or historical borings with limited data.
 8. This is a color figure. Black and white reproduction should not be relied upon as data will be lost.
 9. To prevent scale distortion, this map should be printed on an ANSI "D" size sheet (22x34 inches).
 10. Where past performance and mitigation line features are geographically coincident, symbols have been offset for display purposes.
 11. Surficial geology was mapped at 1:24,000 scale. (Source: Level 2-II Geomorphic Assessment and Surficial Mapping of the Sacramento River below Colusa and Adjoining Areas for NULE Project, URS, 2010).
 12. The information provided on these plates has been compiled from a variety of sources. The URS team does not attest to the accuracy, completeness, or reliability of plan or subsurface data (including geotechnical exploration) by others that are included or referenced in these plates.
 13. These plan and profile drawings are for the use and benefit of DWR, and their consultants in connection with the execution of the NULE Colusa South study area. Use by any other party is at their own discretion and risk. These figures should not be used as the sole basis for design, construction, remedial action, or major capital spending decisions.

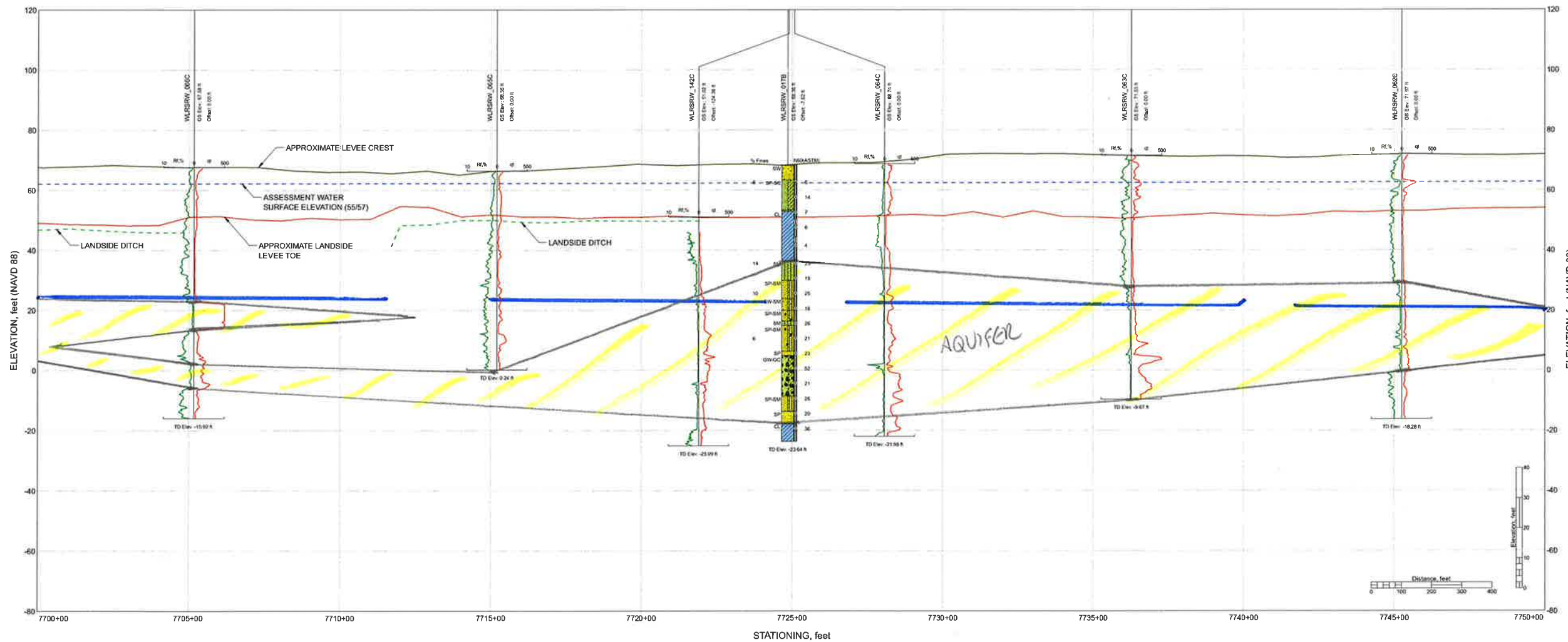

Box 15!

Box 20!

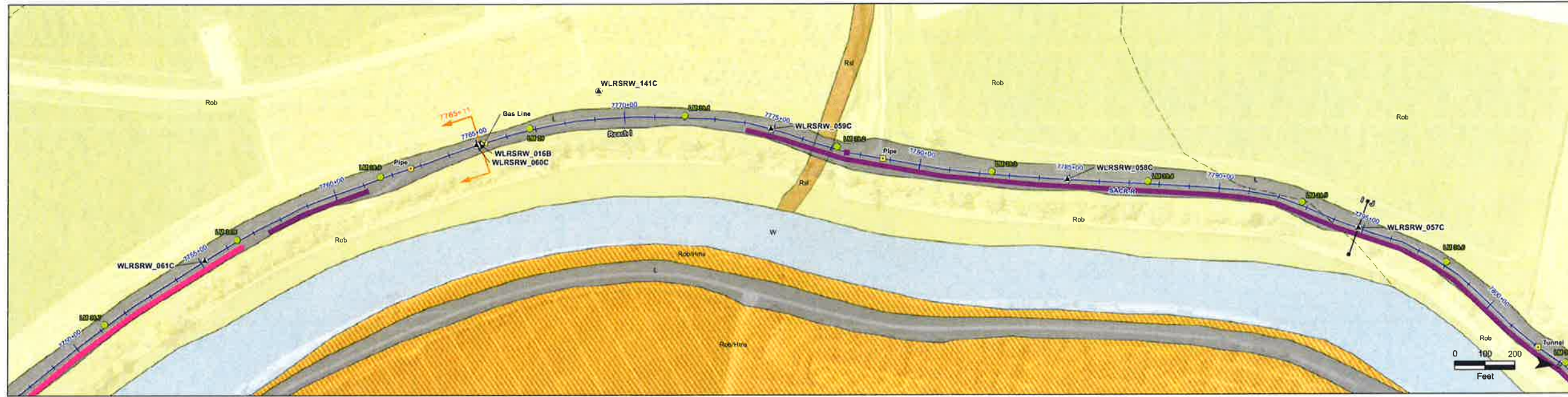

- NOTES:**
1. These plan end profile drawings support the Geotechnical Overview Report and are not intended for any other use or purpose. Please see accompanying report for details.
 2. Elevations of levee crest and landside toe are approximate. Levee crest elevations are from the California Levee Database (CLD) levee centerline and landside toe elevations are based on DWR-provided LIDAR data.
 3. The assessment water surface elevations are based on information provided by DWR.
 4. Where water was present in the ditch at the time LIDAR was flown, the ditch bottom elevation is the water surface elevation. For analysis purposes, the bottom elevation of the ditch was calculated based on a depth of water estimated from available data.
 5. Locations of explorations are approximate. Stick logs represent general soil conditions encountered at the time of exploration. For more detailed information on the materials encountered, refer to boring and CPT logs in the Geotechnical Data Report for the NULE Colusa South study area. No warranty is provided regarding the continuity of soil conditions between individual explorations.
 6. When reported, N_{60} (ASTM) = N field * [Hammer Efficiency(%)/60]. See Geotechnical Data Report for the NULE Colusa South study area for hammer efficiency data for individual borings.
 7. USCS classification labels are not presented on the stick logs for soil layers less than 1.5 feet thick or historical borings with limited data.
 8. This is a color figure. Black and white reproduction should not be relied upon as data will be lost.
 9. To prevent scale distortion, this map should be printed on an ANSI "D" size sheet (22x34 inches).
 10. Where past performance and mitigation line features are geographically coincident, symbols have been offset for display purposes.
 11. Surficial geology was mapped at 1:24,000 scale. (Source: Level 2-II Geomorphic Assessment and Surficial Mapping of the Sacramento River below Colusa and Adjoining Areas for NULE Project, URS, 2010).
 12. The information provided on these plates has been compiled from a variety of sources. The URS team does not attest to the accuracy, completeness, or reliability of plan or subsurface data (including geotechnical exploration) by others that are included or referenced in these plates.
 13. These plan end profile drawings are for the use and benefit of DWR, and their consultants in connection with the execution of the NULE Colusa South study area. Use by any other party is at their own discretion and risk. These figures should not be used as the sole basis for design, construction, remedial action, or major capital spending decisions.

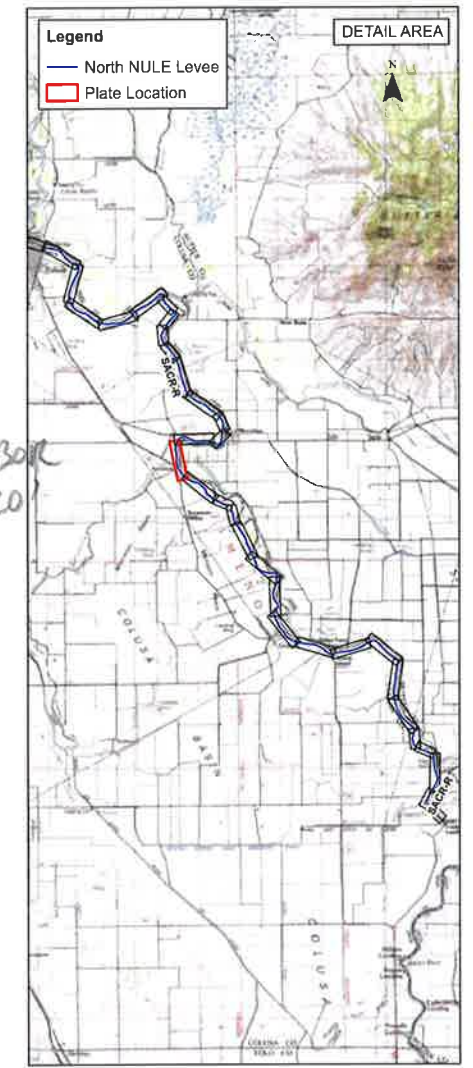
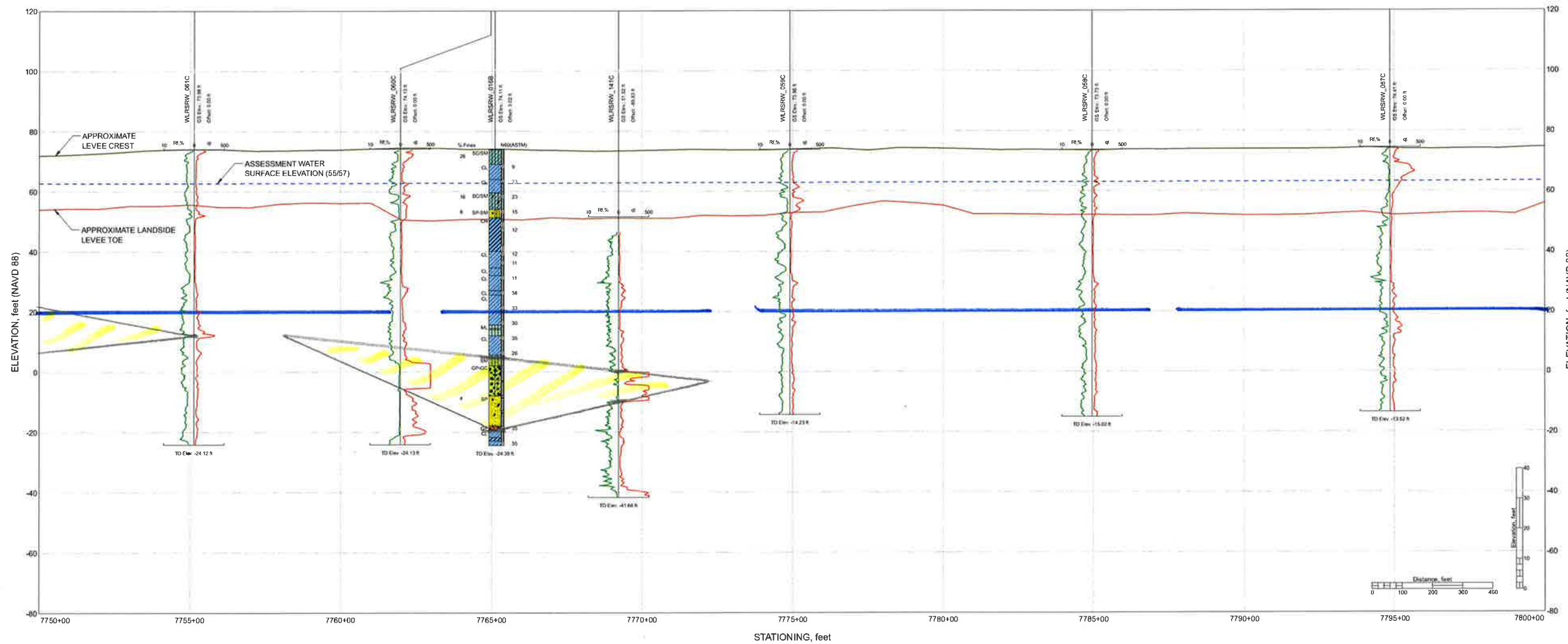

Bore Co

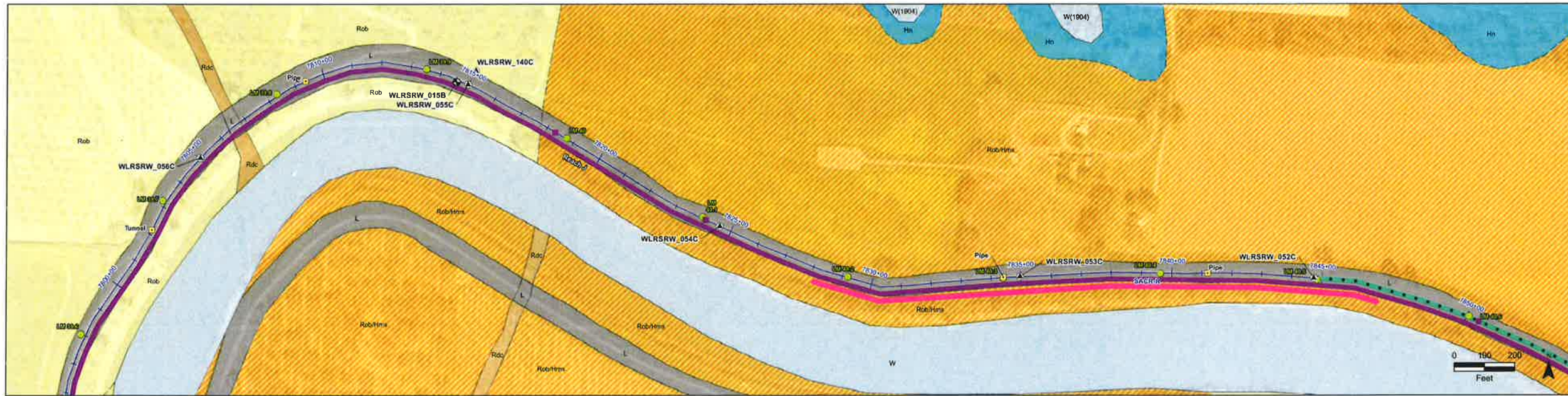

- NOTES:
1. These plan and profile drawings support the Geotechnical Overview Report and are not intended for any other use or purpose. Please see accompanying report for details.
 2. Elevations of levee crest and landside toe are approximate. Levee crest elevations are from the California Levee Database (CLD) levee centerline and landside toe elevations are based on DWR-provided LIDAR data.
 3. The assessment water surface elevations are based on information provided by DWR.
 4. Where water was present in the ditch at the time LIDAR was flown, the ditch bottom elevation is the water surface elevation. For analysis purposes, the bottom elevation of the ditch was calculated based on a depth of water estimated from available data.
 5. Locations of explorations are approximate. Stick logs represent general soil conditions encountered at the line of exploration. For more detailed information on the materials encountered, refer to boring and CPT logs in the Geotechnical Data Report for the NULE Colusa South study area. No warranty is provided regarding the continuity of soil conditions between individual explorations.
 6. When reported, N_{60} (ASTM) = N (ft) * [Hammer Efficiency(%)/60]. See Geotechnical Data Report for the NULE Colusa South study area for hammer efficiency data for individual borings.
 7. USCS classification labels are not presented on the stick logs for soil layers less than 1.5 feet thick or historical borings with limited data.
 8. This is a color figure. Black and white reproduction should not be relied upon as data will be lost.
 9. To prevent scale distortion, this map should be printed on an ANSI "D" size sheet (22x34 inches).
 10. Where past performance and mitigation line features are geographically coincident, symbols have been offset for display purposes.
 11. Surficial geology was mapped at 1:24,000 scale. (Source: Level 2-II Geomorphic Assessment and Surficial Mapping of the Sacramento River below Colusa and Adjoining Areas for NULE Project, URS, 2010)
 12. The information provided on these plates has been compiled from a variety of sources. The URS team does not attest to the accuracy, completeness, or reliability of plan or subsurface data (including geotechnical exploration) by others that are included or referenced in these plates.
 13. These plan and profile drawings are for the use and benefit of DWR, and their consultants in connection with the execution of the NULE Colusa South study area. Use by any other party is at their own discretion and risk. These figures should not be used as the sole basis for design, construction, remedial action, or major capital spending decisions.

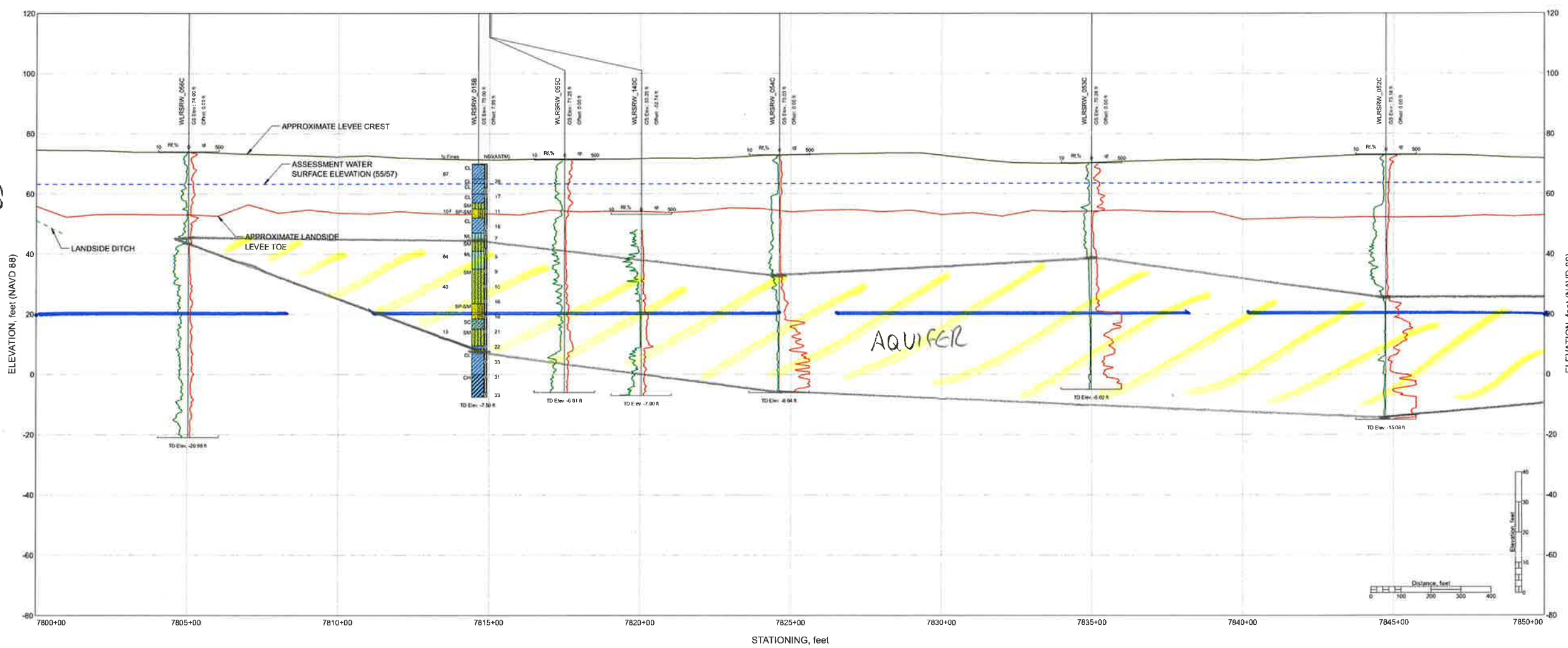

Box 20

Box 20

Aquifer

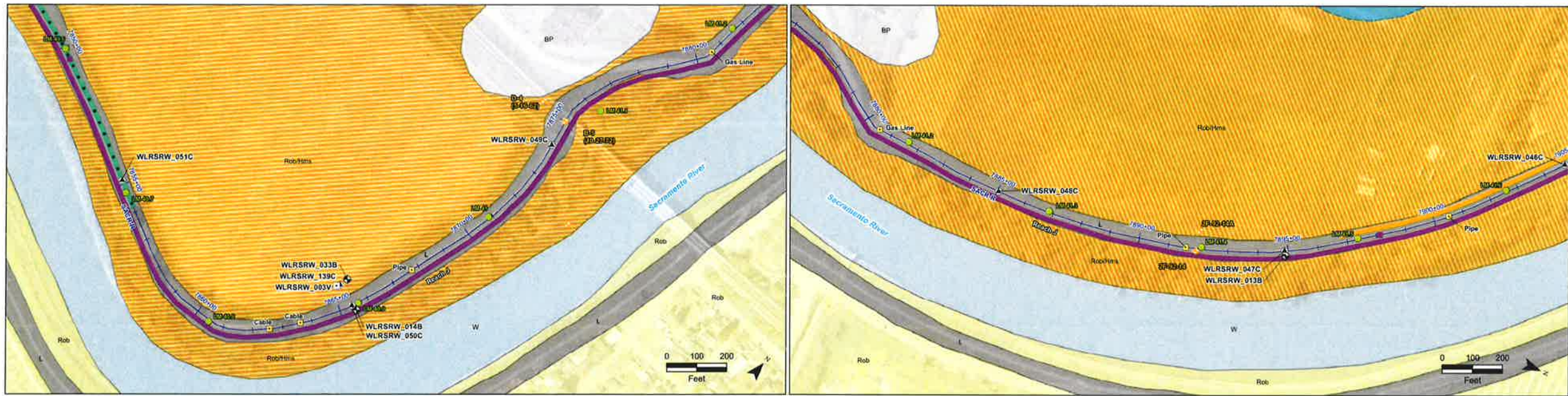

- NOTES:
1. These plan and profile drawings support the Geotechnical Overview Report and are not intended for any other use or purpose. Please see accompanying report for details.
 2. Elevations of levee crest and landside toe are approximate. Levee crest elevations are from the California Levee Database (CLD) levee centerline and landside toe elevations are based DWR-provided LIDAR data.
 3. The assessment water surface elevations are based on information provided by DWR.
 4. Where water was present in the ditch at the time LIDAR was flown, the ditch bottom elevation is the water surface elevation. For analyses purposes, the bottom elevation of the ditch was calculated based on a depth of water estimated from available data.
 5. Locations of explorations are approximate. Stick logs represent general soil conditions encountered at the time of exploration. For more detailed information on the materials encountered, refer to boring and CPT logs in the Geotechnical Data Report for the NULE Colusa South study area. No warranty is provided regarding the continuity of soil conditions between individual explorations.
 6. When reported, N_c (ASTM) = N field * [Hammer Efficiency(%)/60]. See Geotechnical Data Report for the NULE Colusa South study area for hammer efficiency data for individual borings.
 7. USCS classification labels are not presented on the stick logs for soil layers less than 1.5 feet thick or historical borings with limited data.
 8. This is a color figure. Black and white reproduction should not be relied upon as data will be lost.
 9. To prevent scale distortion, this map should be printed on an ANSI "D" size sheet (22x34 inches).
 10. Where past performance and mitigation line features are geographically coincident, symbols have been offset for display purposes.
 11. Surficial geology was mapped at 1:24,000 scale. (Source: Level 2-II Geomorphic Assessment and Surficial Mapping of the Sacramento River below Colusa and Adjoining Areas for NULE Project, URS, 2010).
 12. The information provided on these plates has been compiled from a variety of sources. The URS team does not attest to the accuracy, completeness, or reliability of plan or subsurface data (including geotechnical exploration) by others that are included or referenced in these plates.
 13. These plan and profile drawings are for the use and benefit of DWR, and their consultants in connection with the execution of the NULE Colusa South study area. Use by any other party is at their own discretion and risk. These figures should not be used as the sole basis for design, construction, remediation, or major capital spending decisions.

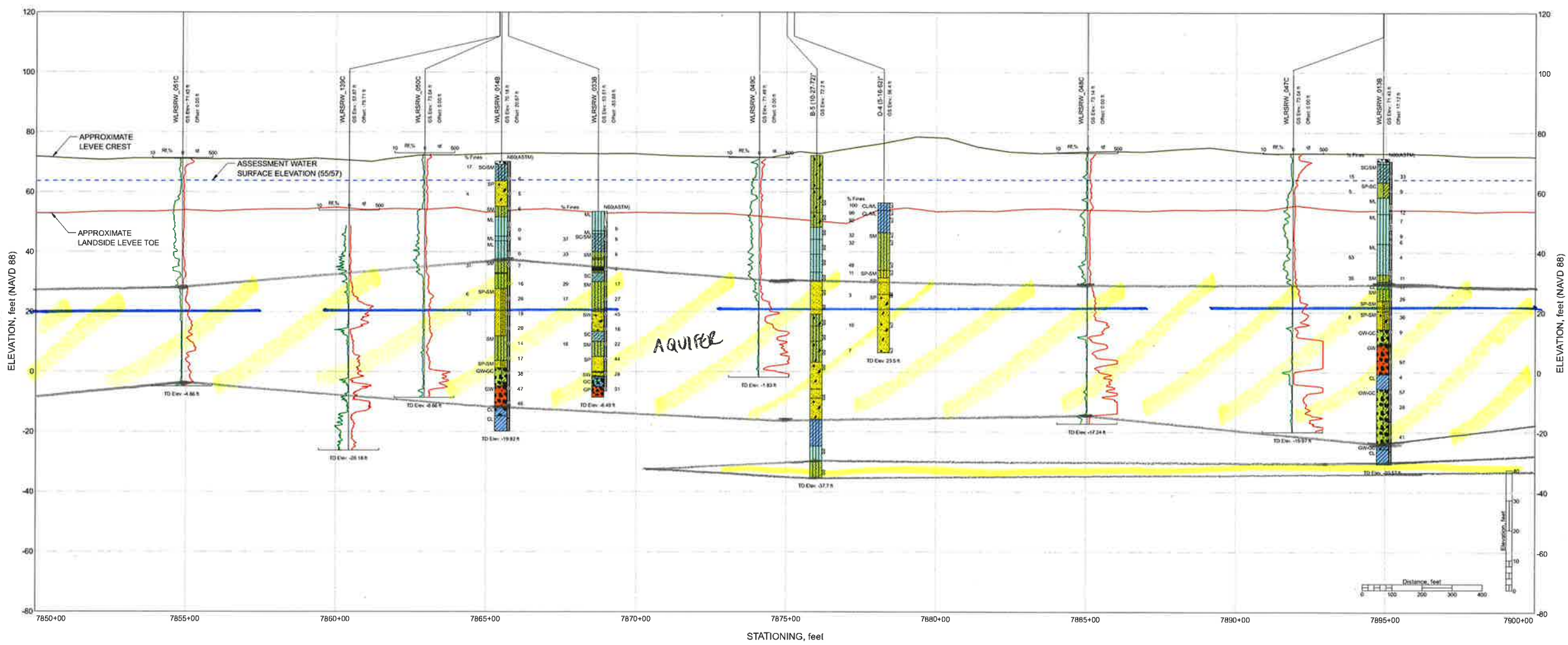

See 201

See 201

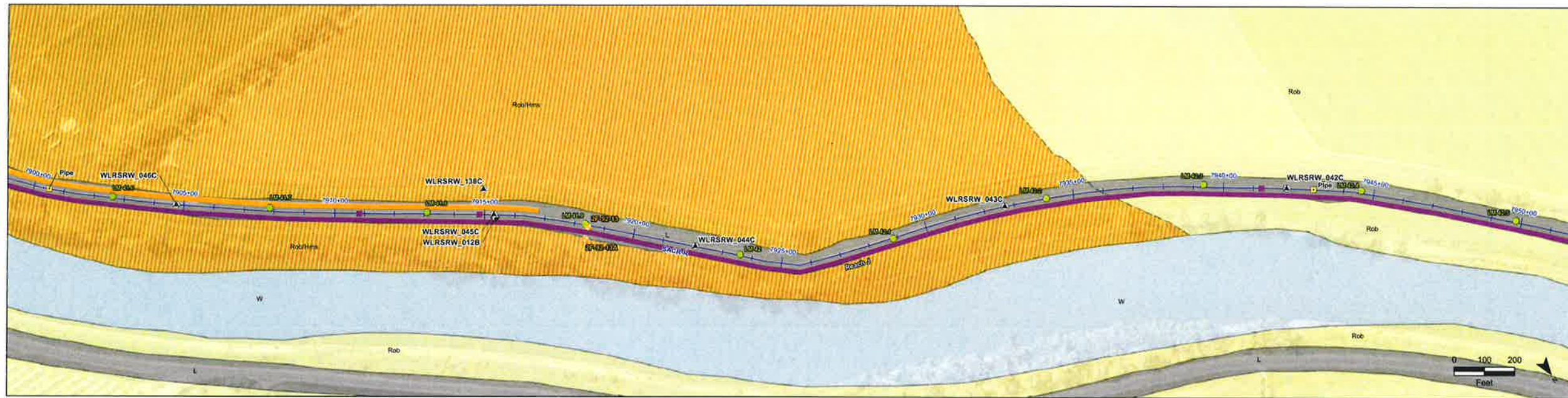

- NOTES:
1. These plan and profile drawings support the Geotechnical Overview Report and are not intended for any other use or purpose. Please see accompanying report for details.
 2. Elevations of levee crest and landside toe are approximate. Levee crest elevations are from the California Levee Database (CLD) levee centerline and landside toe elevations are based on DWR-provided LIDAR data.
 3. The assessment water surface elevations are based on information provided by DWR.
 4. Where water was present in the ditch at the time LIDAR was flown, the ditch bottom elevation is the water surface elevation. For analyses purposes, the bottom elevation of the ditch was calculated based on a depth of water estimated from available data.
 5. Locations of explorations are approximate. Slick logs represent general soil conditions encountered at the time of exploration. For more detailed information on the materials encountered, refer to boring and CPT logs in the Geotechnical Data Report for the NULE Colusa South study area. No warranty is provided regarding the continuity of soil conditions between individual explorations.
 6. When reported, N_c (ASTM) = N field * [Hammer Efficiency (%) / 60]. See Geotechnical Data Report for the NULE Colusa South study area for hammer efficiency data for individual borings.
 7. USCS classification labels are not presented on the slick logs for soil layers less than 1.5 feet thick or historical borings with limited data.
 8. This is a color figure. Black and white reproduction should not be relied upon as data will be lost.
 9. To prevent scale distortion, this map should be printed on an ANSI "D" size sheet (22x34 inches).
 10. Where past performance and mitigation line features are geographically coincident, symbols have been offset for display purposes.
 11. Surficial geology was mapped at 1:24,000 scale. (Source: Level 2-II Geomorphic Assessment and Surficial Mapping of the Sacramento River below Colusa and Adjoining Areas for NULE Project, URS, 2010).
 12. The information provided on these plates has been compiled from a variety of sources. The URS team does not attest to the accuracy, completeness, or reliability of plan or subsurface data (including geotechnical exploration) by others that are included or referenced in these plates.
 13. These plan and profile drawings are for the use and benefit of DWR, and their consultants in connection with the execution of the NULE Colusa South study area. Use by any other party is at their own discretion and risk. These figures should not be used as the sole basis for design, construction, remedial action, or major capital spending decisions.

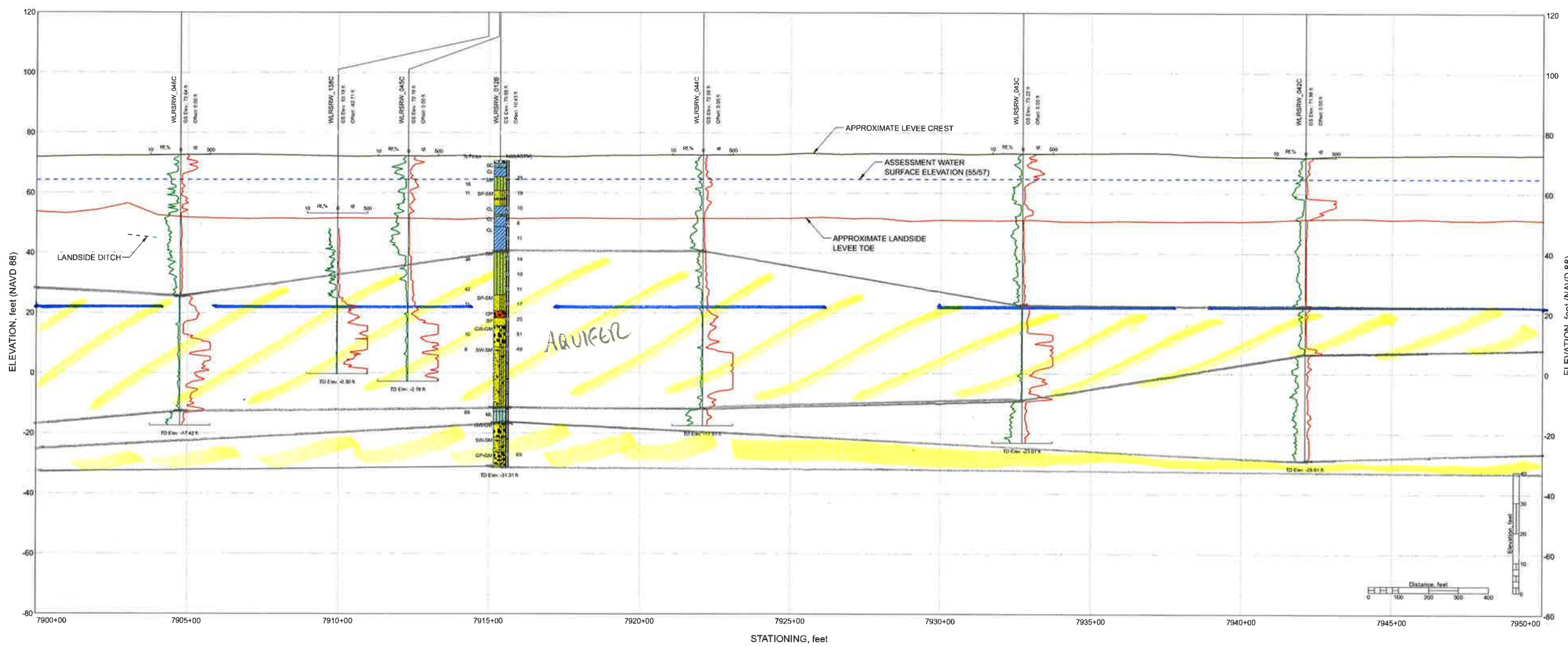

BOUR 21

AQUIFER

BOUR 21

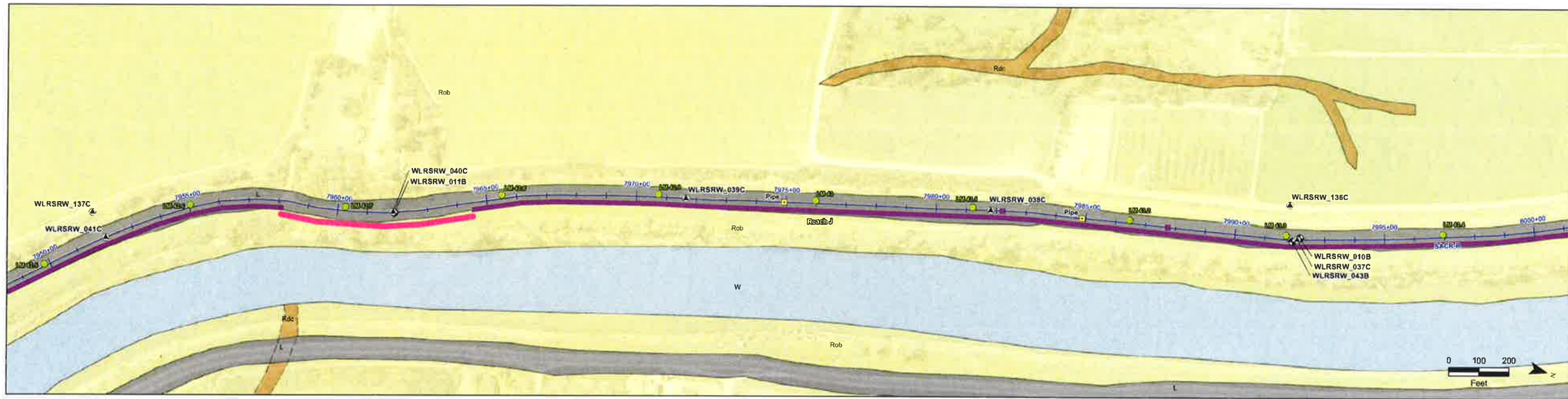

- NOTES:
1. These plan and profile drawings support the Geotechnical Overview Report and are not intended for any other use or purpose. Please see accompanying report for details.
 2. Elevations of levee crest and landside toe are approximate. Levee crest elevations are from the California Levee Database (CLD) levee centerline and landside toe elevations are based on DWR-provided LIDAR data.
 3. The assessment water surface elevations are based on information provided by DWR.
 4. Where water was present in the ditch at the time LIDAR was flown, the ditch bottom elevation is the water surface elevation. For analyses purposes, the bottom elevation of the ditch was calculated based on a depth of water estimated from available data.
 5. Locations of explorations are approximate. Stick logs represent general soil conditions encountered at the time of exploration. For more detailed information on the materials encountered, refer to boring and CPT logs in the Geotechnical Data Report for the NULE Colusa South study area. No warranty is provided regarding the continuity of soil conditions between individual explorations.
 6. When reported, N_u (ASTM) = N field * [Hammer Efficiency (%)] See Geotechnical Data Report for the NULE Colusa South study area for hammer efficiency data for individual borings.
 7. USCS classification labels are not presented on the stick logs for soil layers less than 1.5 feet thick or historical borings with limited data.
 8. This is a color figure. Black and white reproduction should not be relied upon as data will be lost.
 9. To prevent scale distortion, this map should be printed on an ANSI "D" size sheet (22x34 inches).
 10. Where past performance and mitigation line features are geographically coincident, symbols have been offset for display purposes.
 11. Surficial geology was mapped at 1:24,000 scale. (Source: Level 2.0 Geomorphic Assessment and Surficial Mapping of the Sacramento River below Colusa and Adjoining Areas for NULE Project, URS, 2010).
 12. The information provided on these plates has been compiled from a variety of sources. The URS team does not attest to the accuracy, completeness, or reliability of plan or subsurface data (including geotechnical exploration) by others that are included or referenced in these plates.
 13. These plan and profile drawings are for the use and benefit of DWR, and their consultants in connection with the execution of the NULE Colusa South study area. Use by any other party is at their own discretion and risk. These figures should not be used as the sole basis for design, construction, remedial action, or major capital spending decisions.

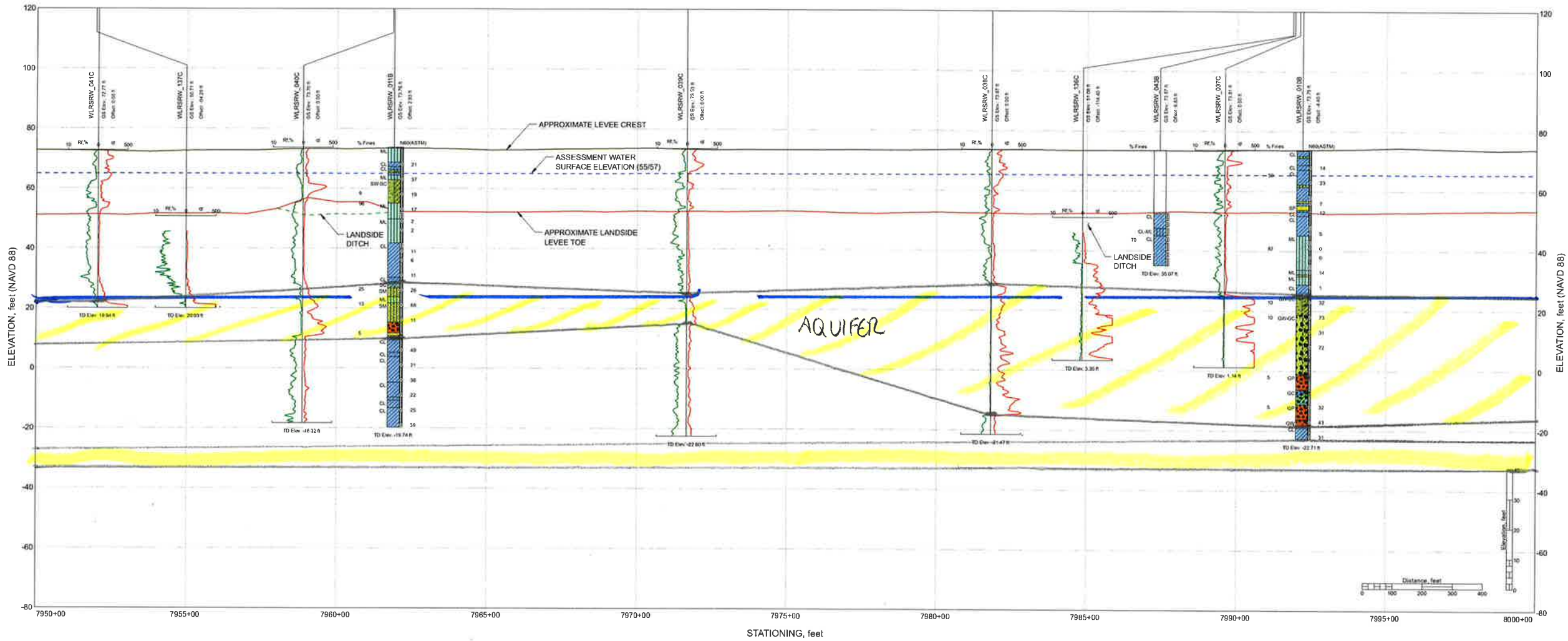

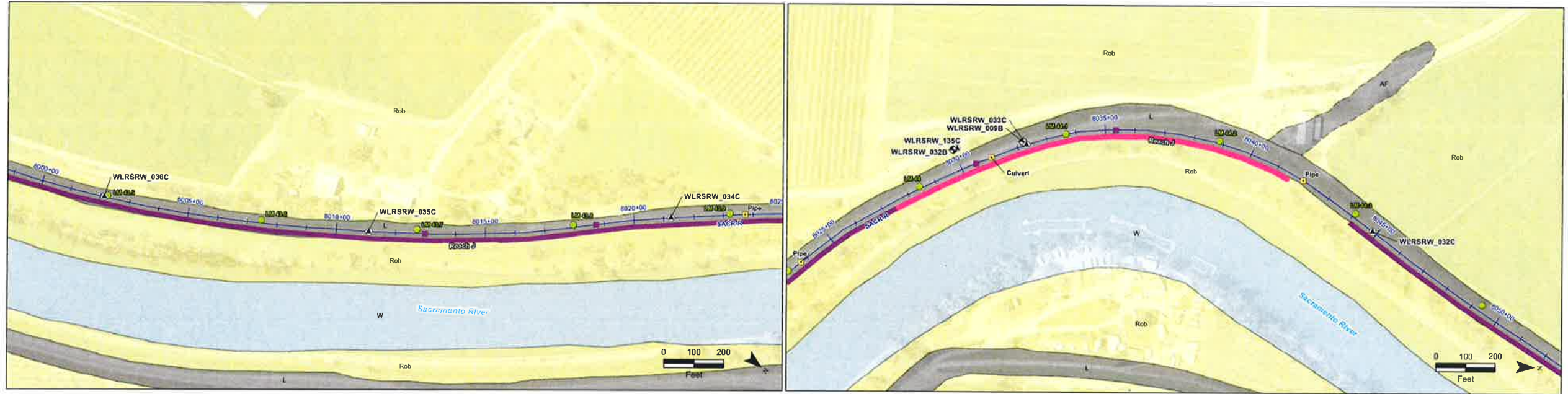

- NOTES:
1. These plan and profile drawings support the Geotechnical Overview Report and are not intended for any other use or purpose. Please see accompanying report for details.
 2. Elevations of levee crest and landside toe are approximate. Levee crest elevations are from the California Levee Database (CLD) levee centerline and landside toe elevations are based on DWR-provided LIDAR data.
 3. The assessment water surface elevations are based on information provided by DWR.
 4. Where water was present in the ditch at the time LIDAR was flown, the ditch bottom elevation is the water surface elevation. For analysis purposes, the bottom elevation of the ditch was calculated based on a depth of water estimated from available data.
 5. Locations of explorations are approximate. Slick logs represent general soil conditions encountered at the time of exploration. For more detailed information on the materials encountered, refer to boring and CPT logs in the Geotechnical Data Report for the NULE Colusa South study area. No warranty is provided regarding the continuity of soil conditions between individual explorations.
 6. When reported, N_u (ASTM) = N field * (Hammer Efficiency %/60). See Geotechnical Data Report for the NULE Colusa South study area for hammer efficiency data for individual borings.
 7. USCS classification labels are not presented on the slick logs for soil layers less than 1.5 feet thick or historical borings with limited data.
 8. This is a color figure. Black and white reproduction should not be relied upon as data will be lost.
 9. To prevent scale distortion, this map should be printed on an ANSI "D" size sheet (22x34 inches).
 10. Where past performance and mitigation line features are geographically coincident, symbols have been offset for display purposes.
 11. Surficial geology was mapped at 1:24,000 scale. (Source: Level 2-II Geomorphic Assessment and Surficial Mapping of the Sacramento River below Colusa and Adjoining Areas for NULE Project, URS, 2010).
 12. The information provided on these plates has been compiled from a variety of sources. The URS team does not attest to the accuracy, completeness, or reliability of plan or sub-surface data (including geotechnical exploration) by others that are included or referenced in these plates.
 13. These plan and profile drawings are for the use and benefit of DWR, and their consultants in connection with the execution of the NULE Colusa South study area. Use by any other party is at their own discretion and risk. These figures should not be used as the sole basis for design, construction, remedial action, or major capital spending decisions.

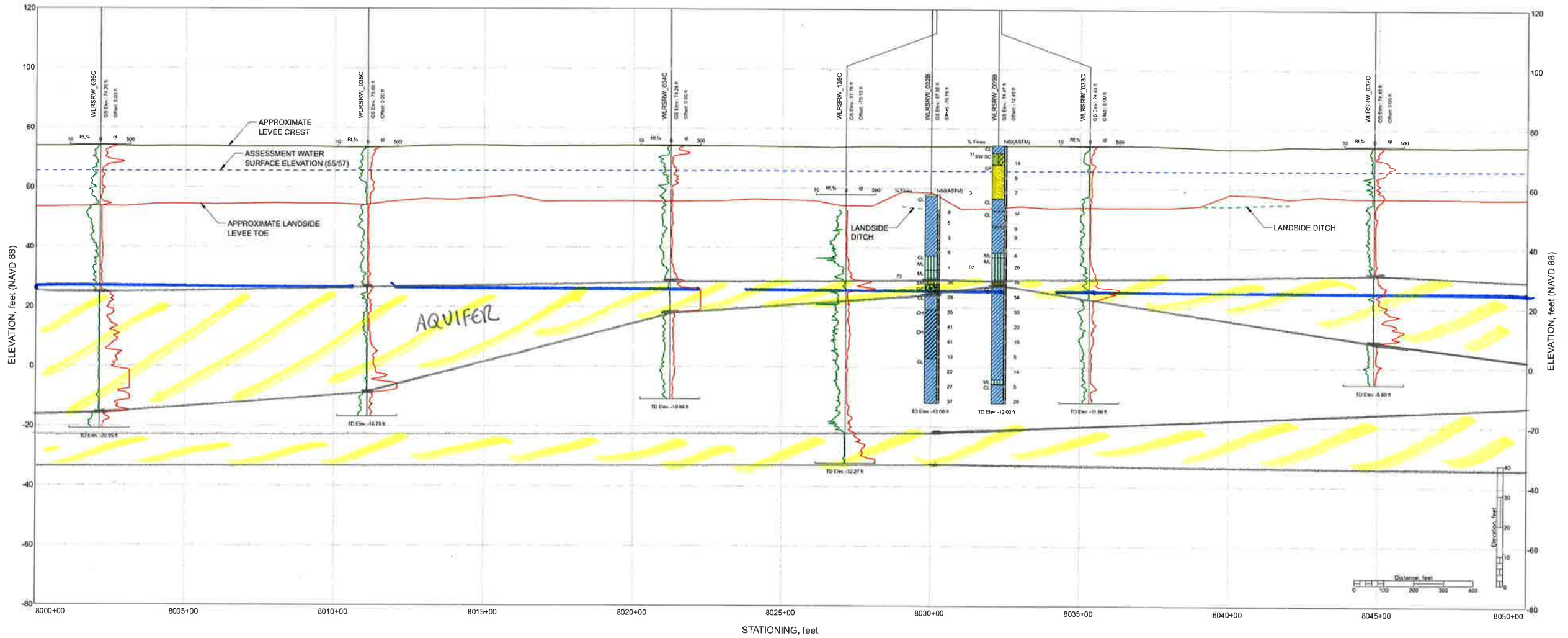

BOR 25

BOR 24



- NOTES:
1. These plan and profile drawings support the Geotechnical Overview Report and are not intended for any other use or purpose. Please see accompanying report for details.
 2. Elevations of levee crest and landside toe are approximate. Levee crest elevations are from the California Levee Database (CLD) levee centerline and landside toe elevations are based on DWR-provided LIDAR data.
 3. The assessment water surface elevations are based on information provided by DWR.
 4. Where water was present in the ditch at the time LIDAR was flown, the ditch bottom elevation is the water surface elevation. For analysis purposes, the bottom elevation of the ditch was calculated based on a depth of water estimated from available data.
 5. Locations of explorations are approximate. Stick logs represent general soil conditions encountered at the time of exploration. For more detailed information on the materials encountered, refer to boring and CPT logs in the Geotechnical Data Report for the NULE Colusa South study area. No warranty is provided regarding the continuity of soil conditions between individual explorations.
 6. When reported, N_p (ASTM) = N_{field} * [Hammer Efficiency (%/50)]. See Geotechnical Data Report for the NULE Colusa South study area for hammer efficiency data for individual borings.
 7. USCS classification labels are not presented on the stick logs for soil layers less than 1.5 feet thick or historical borings with limited data.
 8. This is a color figure. Black and white reproduction should not be relied upon as data will be lost.
 9. To prevent scale distortion, this map should be printed on an ANSI "D" size sheet (22x34 inches).
 10. Where past performance and mitigation line features are geographically coincident, symbols have been offset for display purposes.
 11. Surficial geology was mapped at 1:24,000 scale. (Source: Level 2-II Geomorphic Assessment and Surficial Mapping of the Sacramento River below Colusa and Adjoining Areas for NULE Project, URS, 2010).
 12. The information provided on these plates has been compiled from a variety of sources. The URS team does not attest to the accuracy, completeness, or reliability of plan or subsurface data (including geotechnical exploration) by others that are included or referenced in these plates.
 13. These plan and profile drawings are for the use and benefit of DWR, and their consultants in connection with the execution of the NULE Colusa South study area. Use by any other party is at their own discretion and risk. These figures should not be used as the sole basis for design, construction, remedial action, or major capital spending decisions.

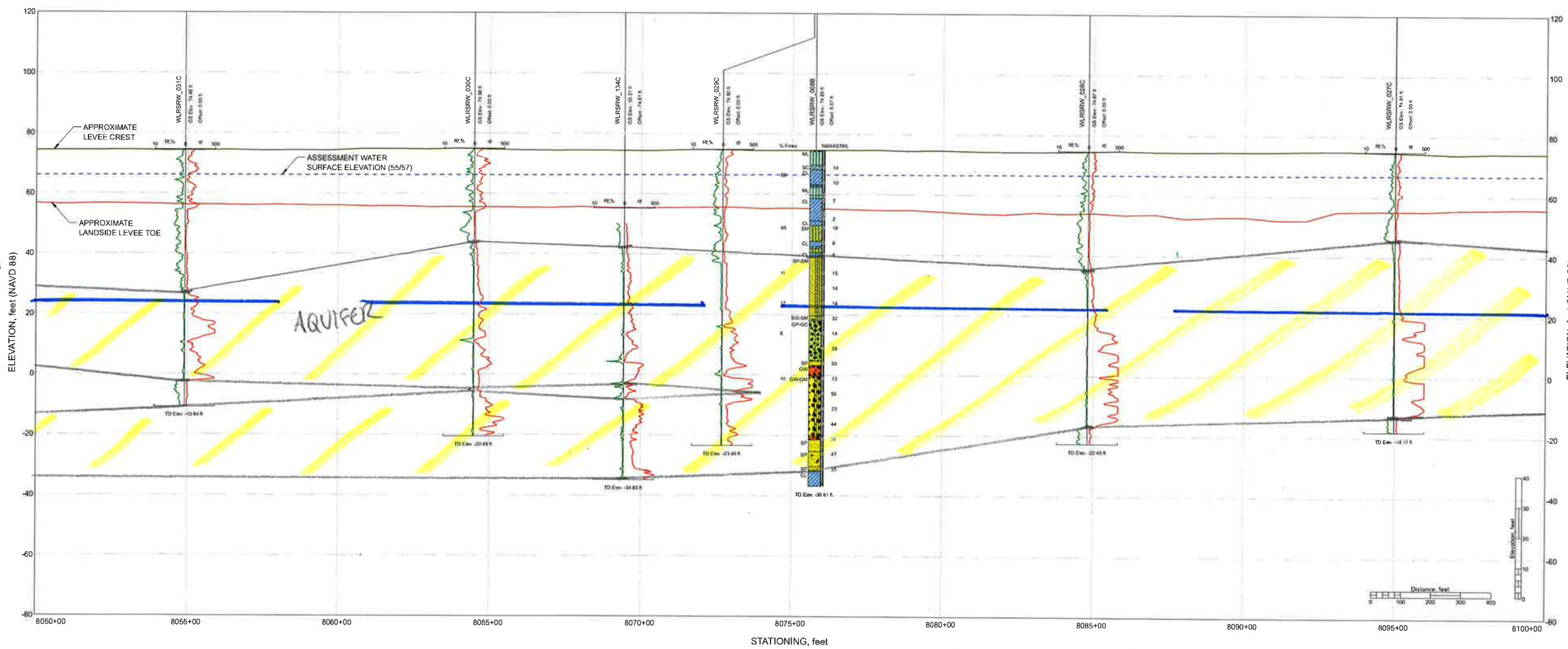

BOR 21

BOR 21

17 June 2013 2:17 PM 10/20/2013 NULE Colusa South Station 8050+00 to Station 8100+00

This page intentionally left blank.

Appendix 5-D
Geologic Sections – Sutter Bypass and Wadsworth Canal

This page intentionally left blank.



- NOTES:
1. Elevations of levee crown and landside for are approximate. These elevations were obtained from NULE LIDAR data and used for geotechnical analysis and report purpose only.
 2. AWSEs are not available due to the 2- to 3-foot levee height, and no available 1955/57 design WSE.
 3. Ditch bottom are shown from LIDAR data which reflects some areas of ditches were dry and other areas were filled with water when data was taken. See GOR for more information.
 4. Locations of explorations are approximate. Stick logs represent general soil conditions encountered at the time of exploration. For more detailed information on the materials encountered, refer to boring and CPT logs in the Geotechnical Data Report for the Sutter Project. No warranty is provided regarding the continuity of soil conditions between individual explorations.
 5. When reported, N_{60} (ASTM) refers to N_{60} (ASTM) = N field * Hammer Efficiency (%). See Geotechnical Data Report for the Sutter GOR Project for hammer efficiency data for individual borings.
 6. USCS classification labels are not presented on the stick logs for soil lenses (thickness less than 1.5 feet).
 7. This is a color figure. Black and white reproduction should not be relied upon as data will be lost.
 8. To prevent scale distortion, this map should be printed on a "D" size sheet (22x34 inches).
 9. Surficial geology was mapped at 1:24000 scale. (Source: SGDR for DWR ULE Project, URS, 2010).
 10. The information provided in these plans and stick-log plates has been compiled from a variety of sources. URS does not attest to the accuracy, completeness, or reliability of geotechnical exploration and other subsurface data by others that are included or referenced in these plates.
 11. These plans and stick-log plates are for the use and benefit of DWR, and their consultants in connection with the execution of the Sutter Project. Use by any other party is at their own discretion and risk. These figures should not be used as the sole basis for design, construction, remedial action, or major capital spending decisions.

No BATHYMETRY

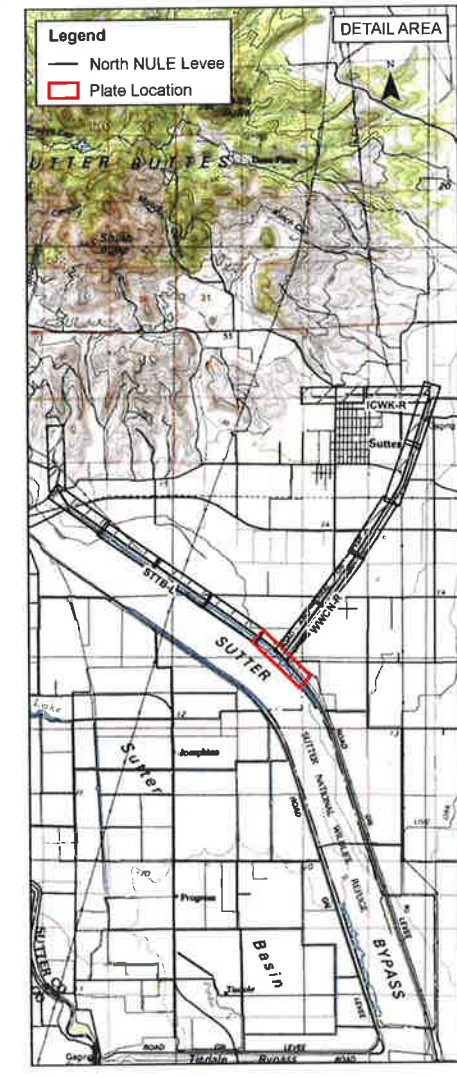
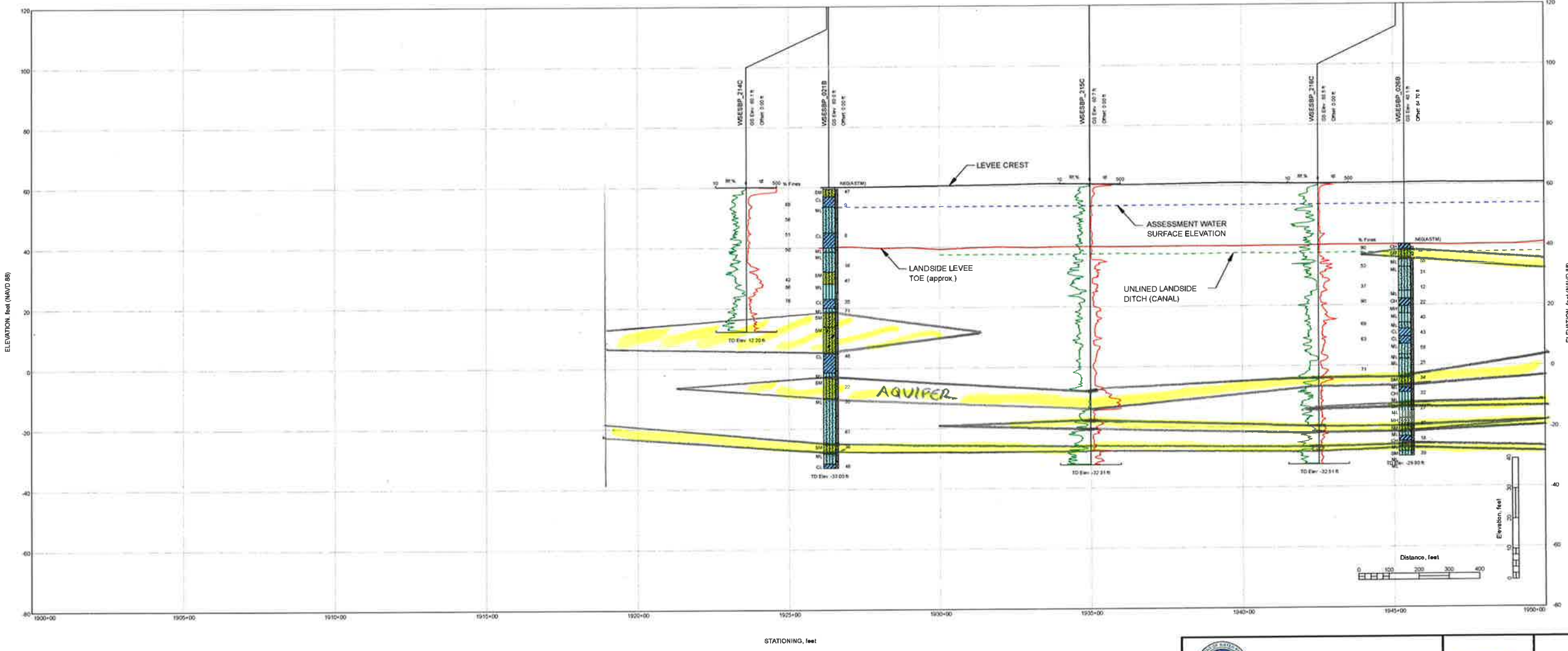

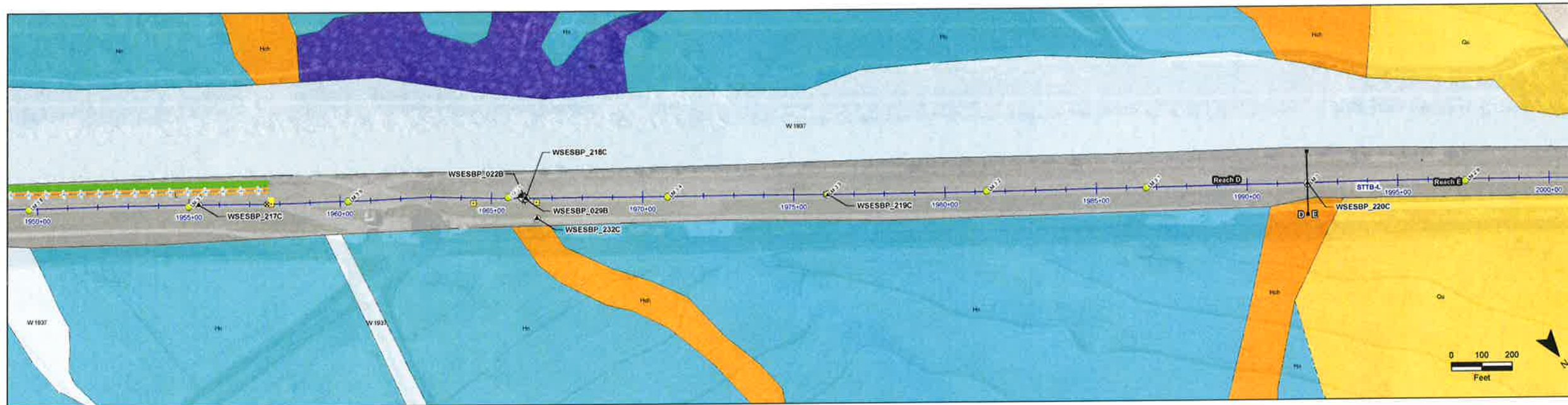

- NOTES:
1. Elevations of levee crown and landside toe are approximate. These elevations were obtained from NULE LIDAR data and used for geotechnical analyses and report purpose only.
 2. AWSEs are not available due to the 2- to 3-foot levee height, and no available 1955/57 design WSE.
 3. Ditch bottom are shown from LIDAR data which reflects some areas of ditches were dry and other areas were filled with water when data was taken. See GOR for more information.
 4. Locations of explorations are approximate. Stick logs represent general soil conditions encountered at the time of exploration. For more detailed information on the materials encountered, refer to boring and CPT logs in the Geotechnical Data Report for the Sutter Project. No warranty is provided regarding the continuity of soil conditions between individual explorations.
 5. When reported, N_u (ASTM) refers to N_u (ASTM) = N field * Hammer Efficiency (%). See Geotechnical Data Report for the Sutter GOR Project for hammer efficiency data for individual borings.
 6. USCS classification labels are not presented on the stick logs for soil lenses (thickness less than 1.5 feet).
 7. This is a color figure. Black and white reproduction should not be relied upon as data will be lost.
 8. To prevent scale distortion, this map should be printed on a "D" size sheet (22x34 inches).
 9. Surficial geology was mapped at 1:24000 scale. (Source: SDDR for DWR ULE Project, URS, 2010)
 10. The information provided in these plans and stick-log plates has been compiled from a variety of sources. URS does not attest to the accuracy, completeness, or reliability of geotechnical exploration and other subsurface data by others that are included or referenced in these plates.
 11. These plans and stick-log plates are for the use and benefit of DWR, and their consultants in connection with the execution of the Sutter Project. Use by any other party is at their own discretion and risk. These figures should not be used as the sole basis for design, construction, remedial action, or major capital spending decisions.

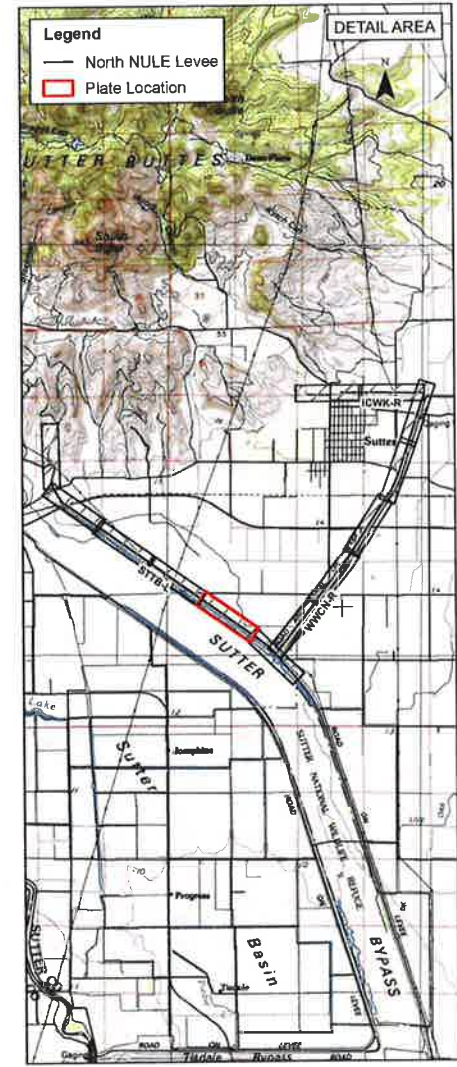
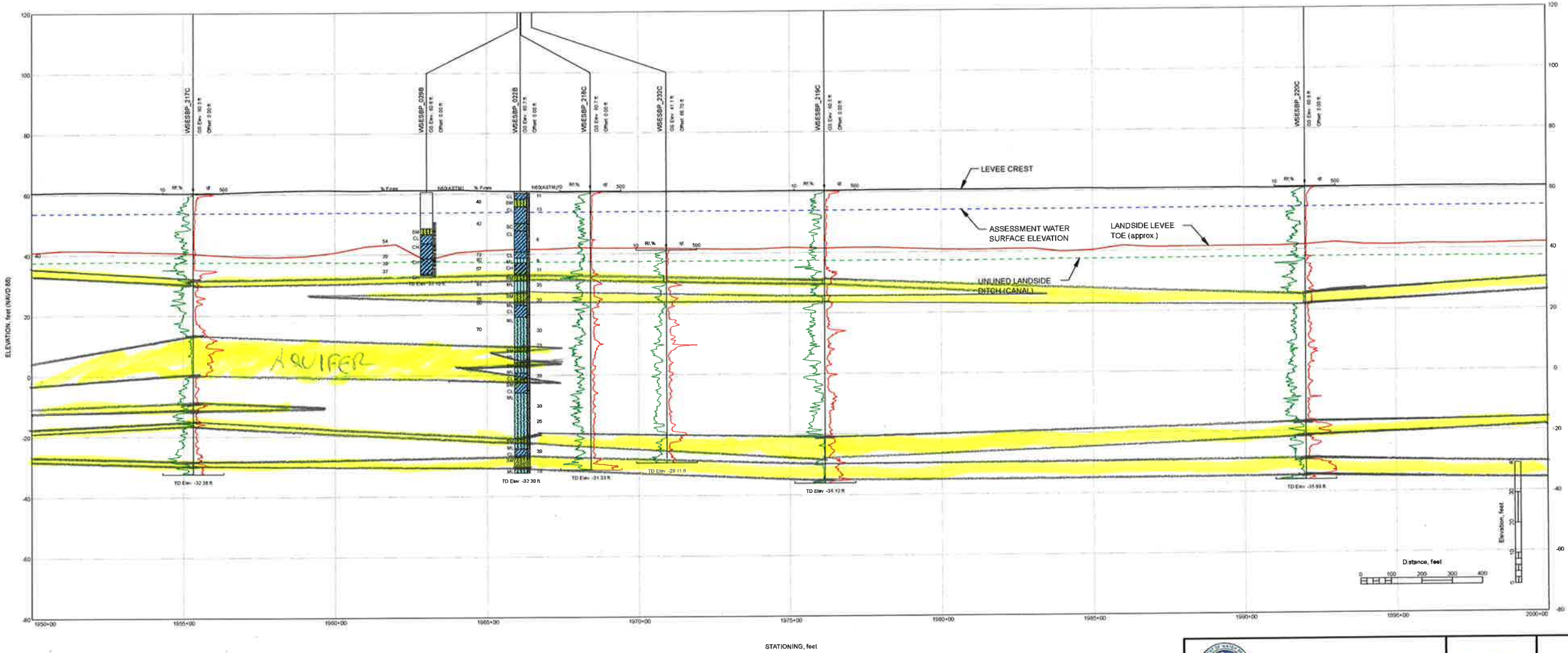

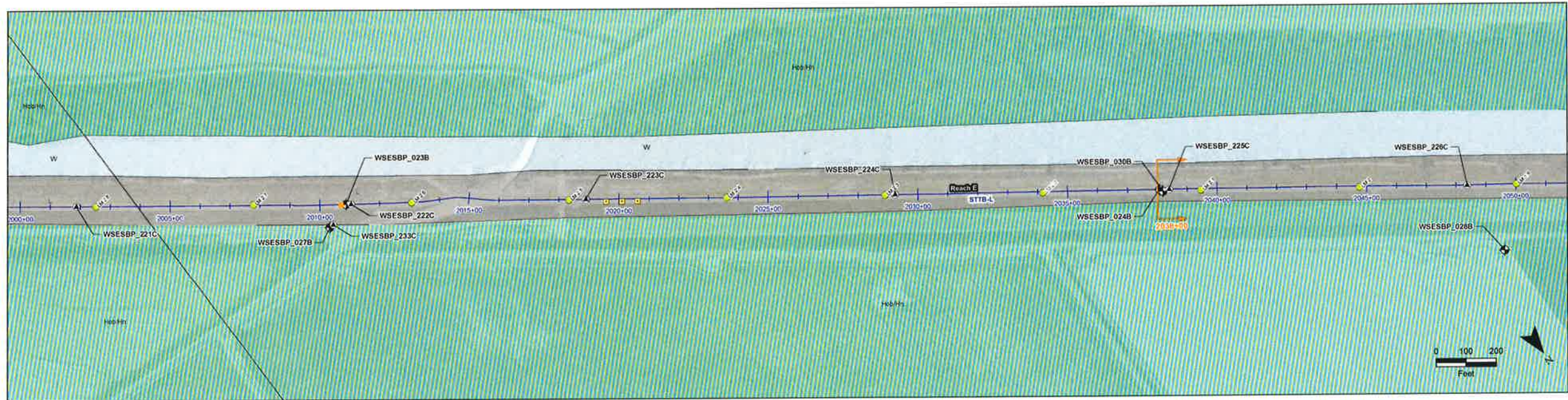

- NOTES
- Elevations of levee crown and landside toe are approximate. These elevations were obtained from NULE LIDAR data and used for geotechnical analyses and report purpose only.
 - AWSEs are not available due to the 2- to 3-foot levee height, and no available 1955-57 design WSE.
 - Ditch bottom are shown from LIDAR data which reflects some areas of ditches were dry and other areas were filled with water when data was taken. See GOR for more information.
 - Locations of explorations are approximate. Stick logs represent general soil conditions encountered at the time of exploration. For more detailed information on the materials encountered, refer to boring and CPT logs in the Geotechnical Data Report for the Sutter Project. No warranty is provided regarding the continuity of soil conditions between individual explorations.
 - When reported, N_{60} (ASTM) refers to N_{60} (ASTM) = N field * Hammer Efficiency (%). See Geotechnical Data Report for the Sutter GOR Project for hammer efficiency data for individual borings.
 - USCS classification labels are not presented on the stick logs for soil lenses (thickness less than 1.5 feet).
 - This is a color figure. Black and white reproduction should not be relied upon as data will be lost.
 - To prevent scale distortion, this map should be printed on a "D" size sheet (22x34 inches).
 - Surficial geology was mapped at 1:24000 scale. (Source: SGDR for DWR ULE Project, URS, 2010)
 - The information provided in these plans and stick-log plates has been compiled from a variety of sources. URS does not attest to the accuracy, completeness, or reliability of geotechnical exploration and other subsurface data by others that are included or referenced in these plates.
 - These plans and stick-log plates are for the use and benefit of DWR, and their consultants in connection with the execution of the Sutter Project. Use by any other party is at their own discretion and risk. These figures should not be used as the sole basis for design, construction, remedial action, or major capital spending decisions.

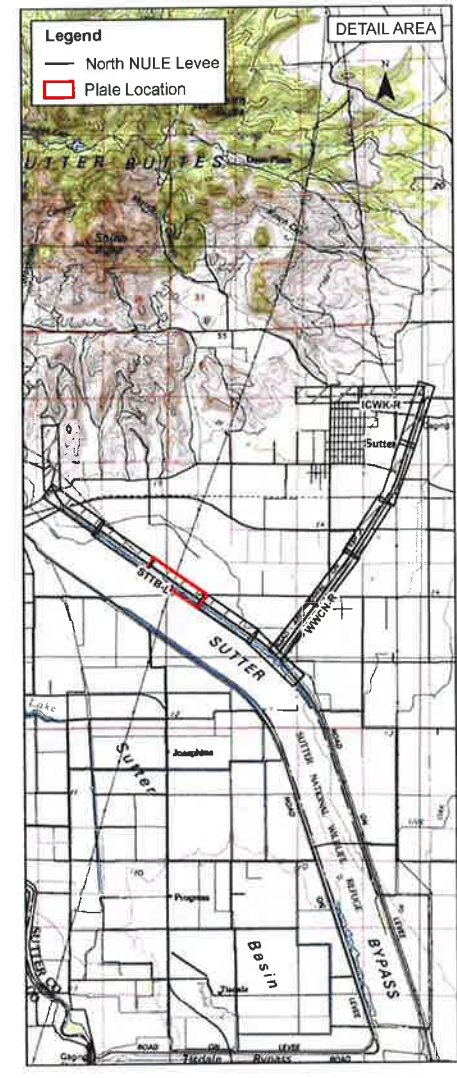
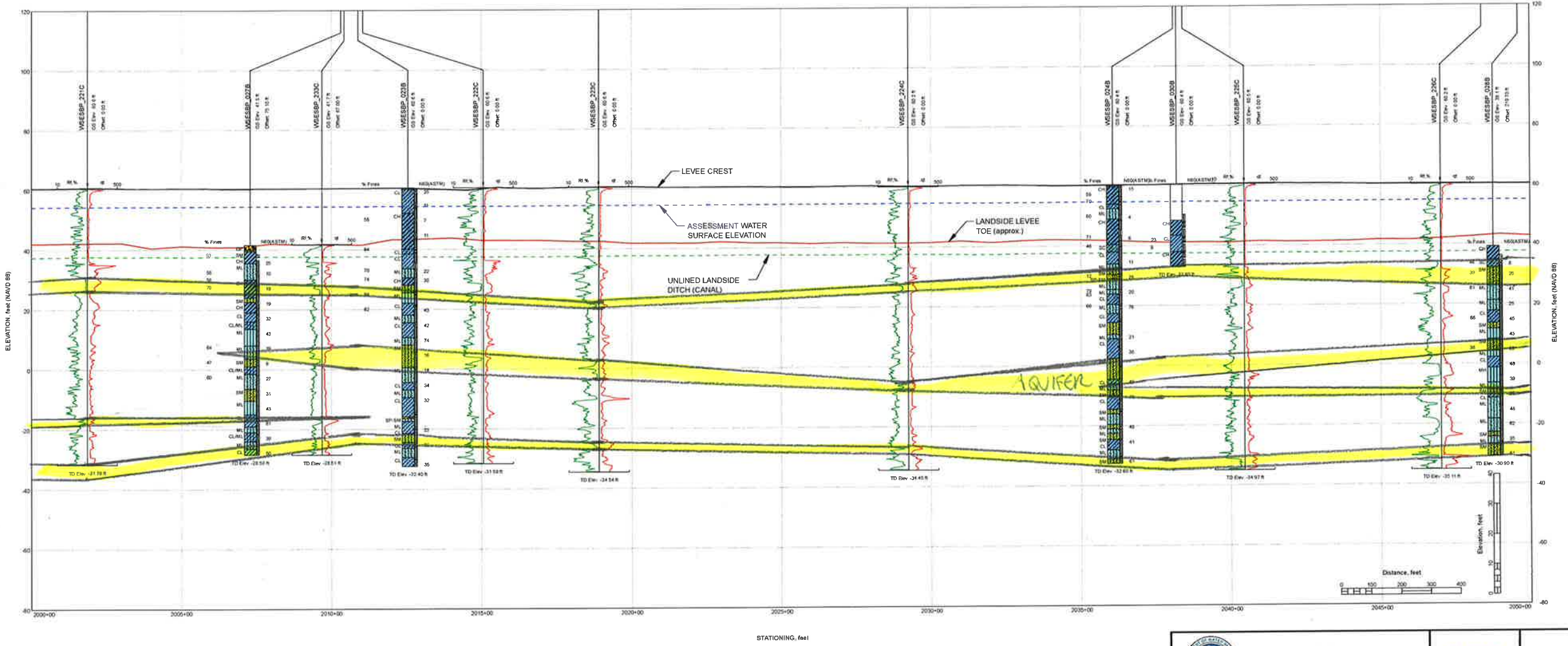

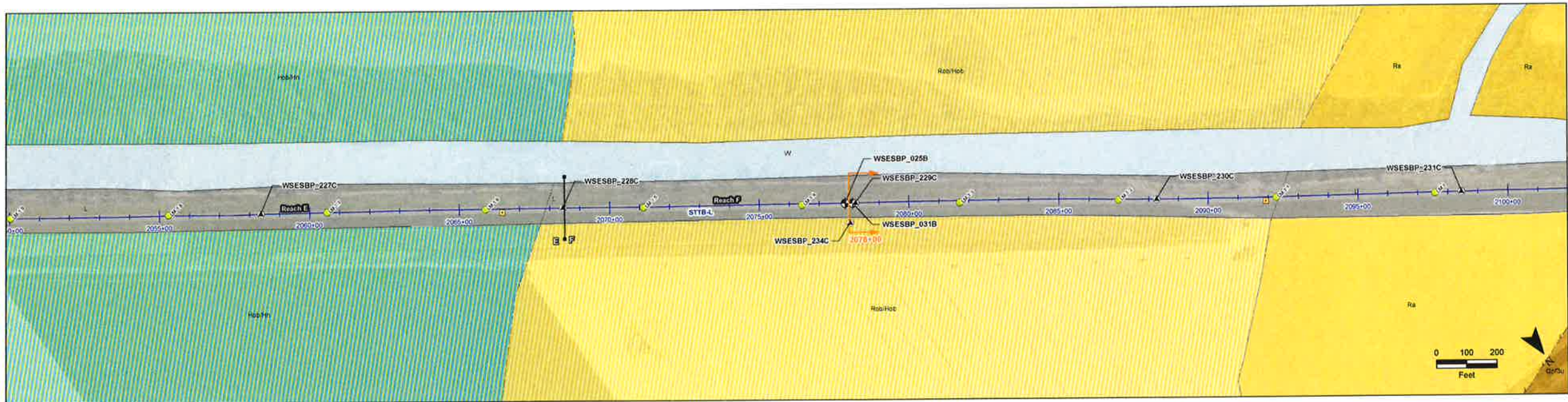

- NOTES:
- Elevations of levee crown and landside toe are approximate. These elevations were obtained from NULE LIDAR data and used for geotechnical analyses and report purpose only.
 - AWSEs are not available due to the 2- to 3-foot levee height, and no available 1995/97 design WSE.
 - Ditch bottom are shown from LIDAR data which reflects some areas of ditches were dry and other areas were filled with water when data was taken. See GOR for more information.
 - Locations of explorations are approximate. Stick logs represent general soil conditions encountered at the time of exploration. For more detailed information on the materials encountered, refer to boring and CPT logs in the Geotechnical Data Report for the Sutter Project. No warranty is provided regarding the continuity of soil conditions between individual explorations.
 - When reported, N_u (ASTM) refers to N_u (ASTM) = N field * Hammer Efficiency (%). See Geotechnical Data Report for the Sutter GOR Project for hammer efficiency data for individual borings.
 - USCS classification labels are not presented on the stick logs for soil lenses (thickness less than 1.5 feet).
 - This is a color figure. Black and white reproduction should not be relied upon as data will be lost.
 - To prevent scale distortion, this map should be printed on a "D" size sheet (22x34 inches).
 - Surficial geology was mapped at 1:24000 scale. (Source: SCDR for DWR ULE Project, URS, 2010).
 - The information provided in these plans and stick-log plates has been compiled from a variety of sources. URS does not attest to the accuracy, completeness, or reliability of geotechnical exploration and other subsurface data by others that are included or referenced in these plans.
 - These plans and stick-log plates are for the use and benefit of DWR, and their consultants in connection with the execution of the Sutter Project. Use by any other party is at their own discretion and risk. These figures should not be used as the sole basis for design, construction, remedial action, or major capital spending decisions.

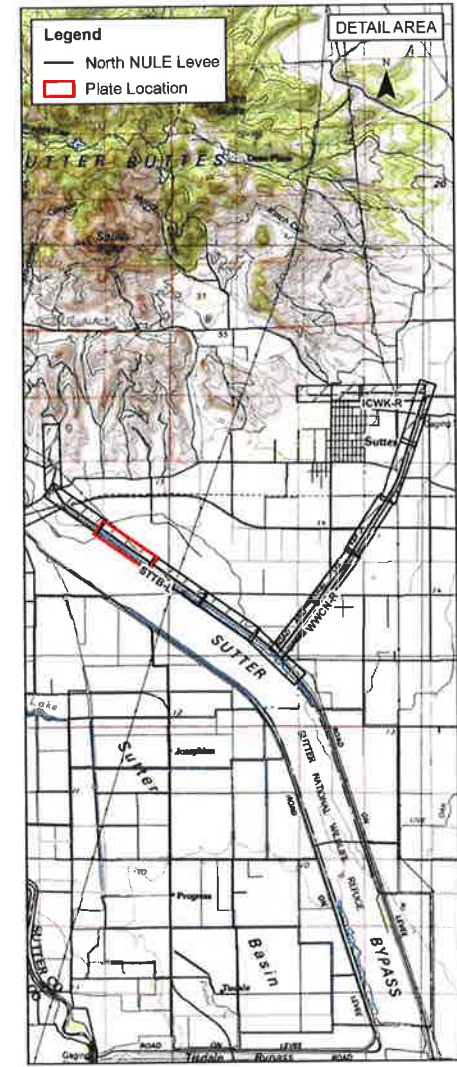
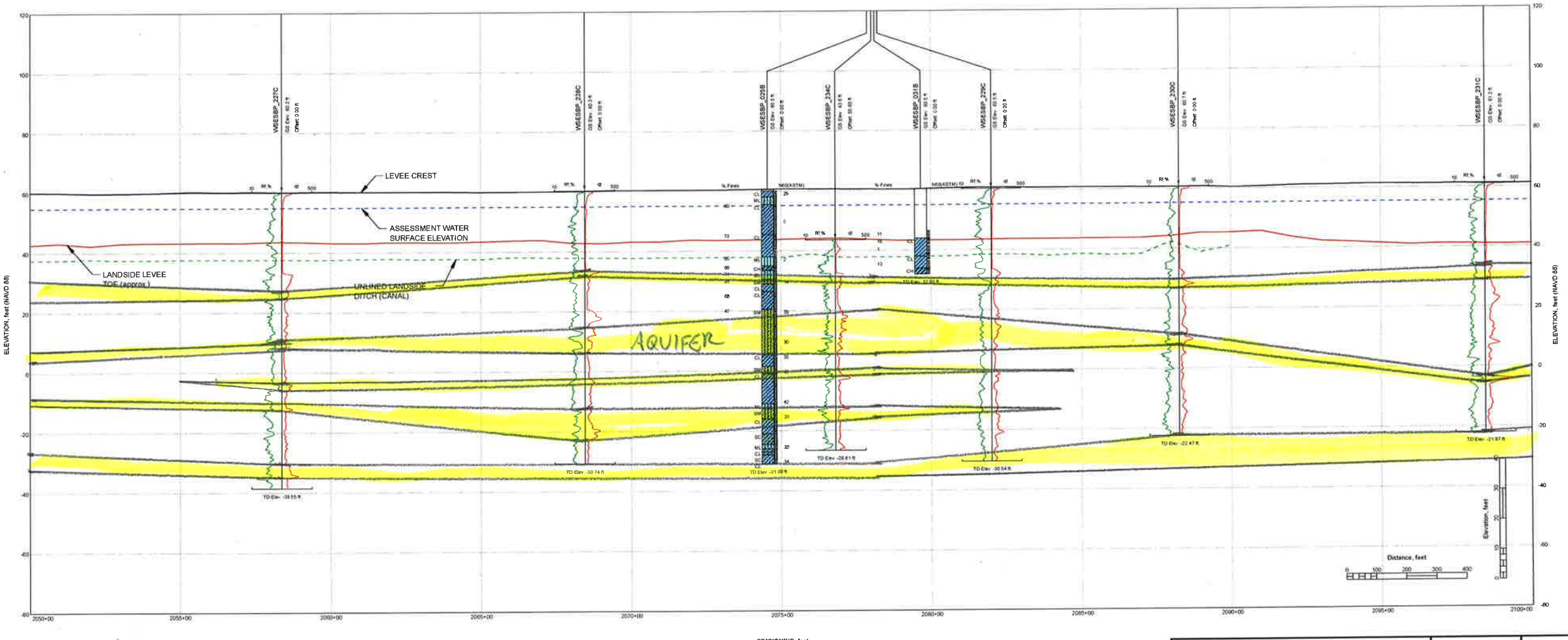

I:\sutter\GIS\Geotechnical\Map\Legend.mxd; User:GREGORY; Title: Geotechnical Overview Report; Date: 06/11/2013 10:34:33 AM

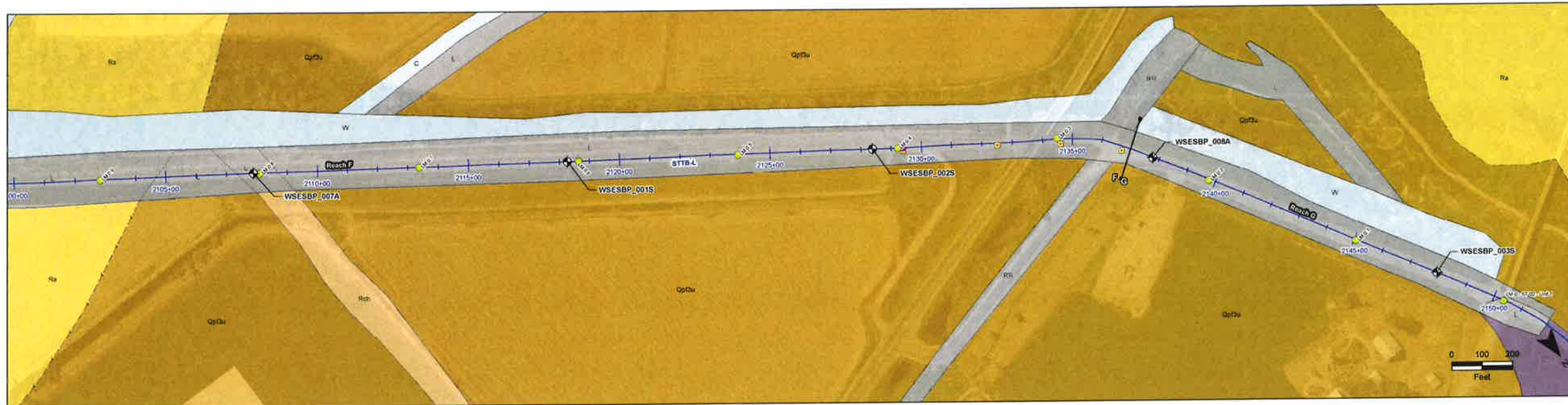

- NOTES:
- Elevations of levee crown and landside toe are approximate. These elevations were obtained from NULE LIDAR data and used for geotechnical analyses and report purpose only.
 - AWSEs are not available due to the 2- to 3-foot levee height, and no available 1950/57 design WSE.
 - Ditch bottom are shown from LIDAR data which reflects some areas if ditches were dry and other areas were filled with water when data was taken. See GOR for more information.
 - Locations of explorations are approximate. Stick logs represent general soil conditions encountered at the time of exploration. For more detailed information on the materials encountered, refer to boring and CPT logs in the Geotechnical Data Report for the Sutter Project. No warranty is provided regarding the continuity of soil conditions between individual explorations.
 - When reported, N_{60} (ASTM) refers to N_{60} (ASTM) = N field * Hammer Efficiency (%). See Geotechnical Data Report for the Sutter GOR Project for hammer efficiency data for individual borings.
 - USCS classification labels are not presented on the stick logs for soil lenses (thickness less than 1.5 feet).
 - This is a color figure. Black and white reproduction should not be relied upon as data will be lost.
 - To prevent scale distortion, this map should be printed on a "D" size sheet (22x34 inches).
 - Surficial geology was mapped at 1:24,000 scale. (Source: SODR for DWR ULE Project, URS, 2010)
 - The information provided in these plans and stick-log plates has been compiled from a variety of sources. URS does not attest to the accuracy, completeness, or reliability of geotechnical exploration and other subsurface data by others that are included or referenced in these plates.
 - These plans and stick-log plates are for the use and benefit of DWR, and their consultants in connection with the execution of the Sutter Project. Use by any other party is at their own discretion and risk. These figures should not be used as the sole basis for design, construction, remedial action, or major capital spending decisions.

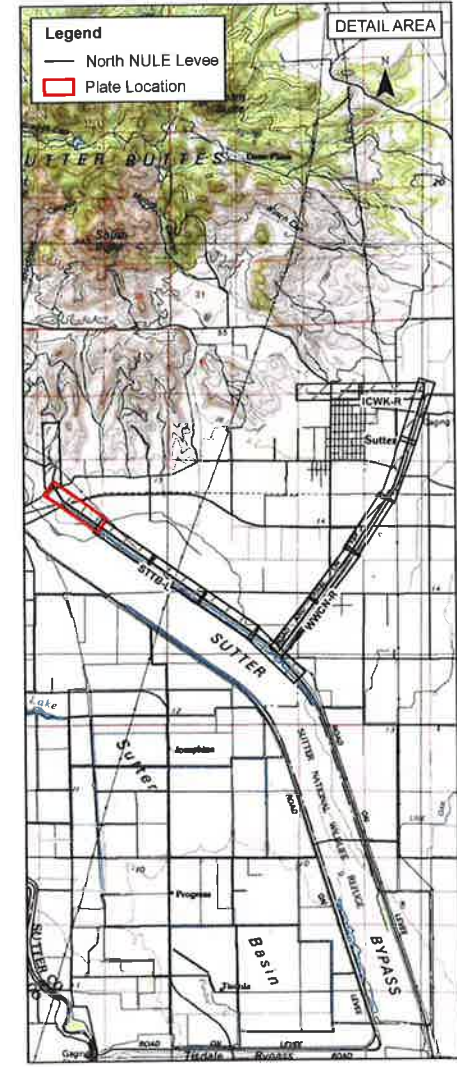
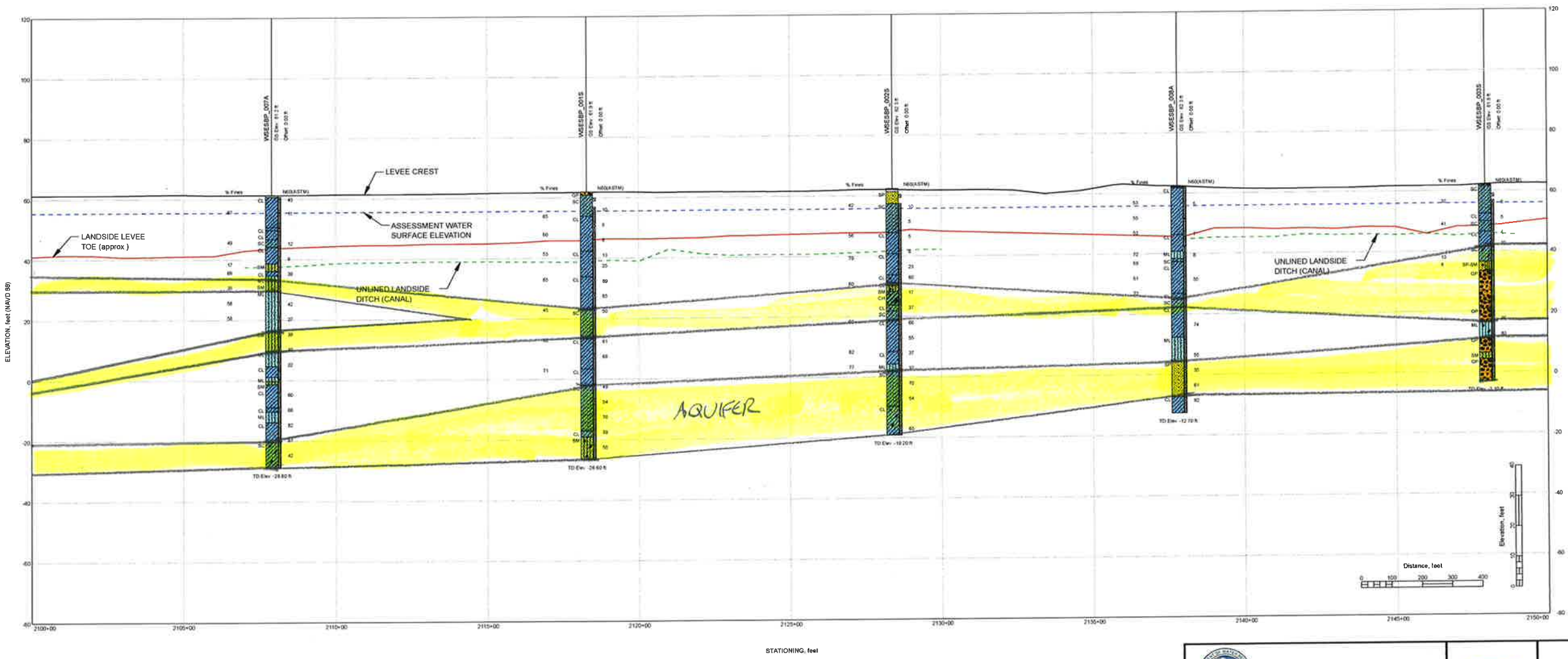



- NOTES:
1. Elevations of levee crown and landside toe are approximate. These elevations were obtained from NULE LIDAR data and used for geotechnical analyses and report purpose only.
 2. AWSEs are not available due to the 2- to 3-foot levee height, and no available 1955/57 design WSE.
 3. Ditch bottom are shown from LIDAR data which reflects some areas of ditches were dry and other areas were filled with water when data was taken. See GOR for more information.
 4. Locations of explorations are approximate. Slick logs represent general soil conditions encountered at the time of exploration. For more detailed information on the materials encountered, refer to boring and CPT logs in the Geotechnical Data Report for the Sutter Project. No warranty is provided regarding the continuity of soil conditions between individual explorations.
 5. When reported, N_{60} (ASTM) refers to N_{60} (ASTM) = N field * Hammer Efficiency (%). See Geotechnical Data Report for the Sutter GOR Project for hammer efficiency data for individual borings.
 6. USCS classification labels are not presented on the slick logs for soil lenses (thickness less than 1.5 feet).
 7. This is a color figure. Black and white reproduction should not be relied upon as data will be lost.
 8. To prevent scale distortion, this map should be printed on a "D" size sheet (22x34 inches).
 9. Surficial geology was mapped at 1:24000 scale. (Source: SGDR for DWR ULE Project, URS 2010).
 10. The information provided in these plans and stick-log plates has been compiled from a variety of sources. URS does not attest to the accuracy, completeness, or reliability of geotechnical exploration and other subsurface data by others that are included or referenced in these plates.
 11. These plans and stick-log plates are for the use and benefit of DWR, and their consultants in connection with the execution of the Sutter Project. Use by any other party is at their own discretion and risk. These figures should not be used as the sole basis for design, construction, remedial action, or major capital spending decisions.

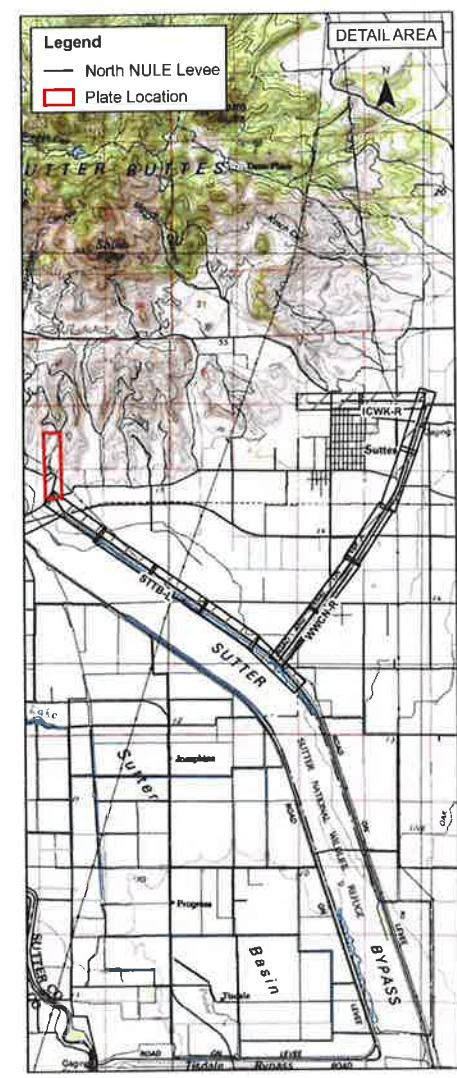
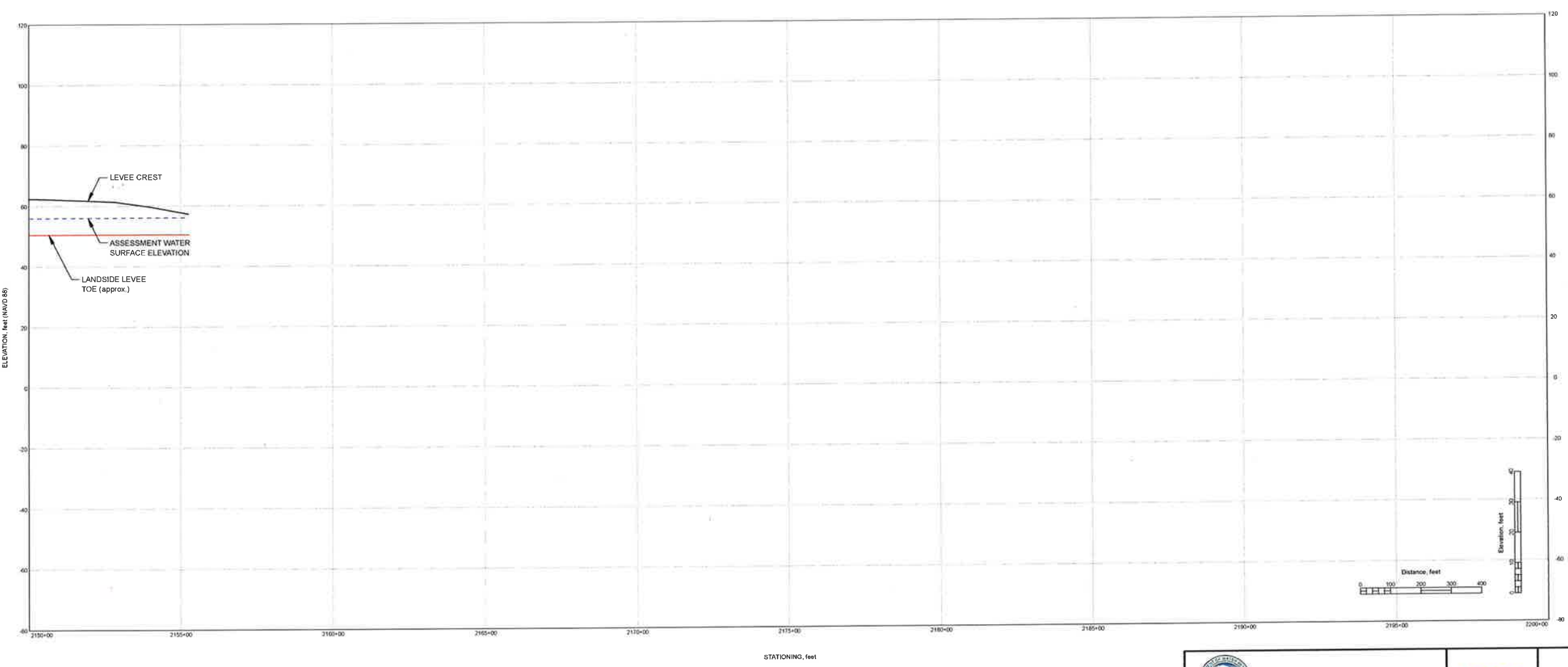

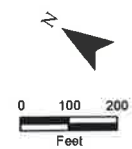
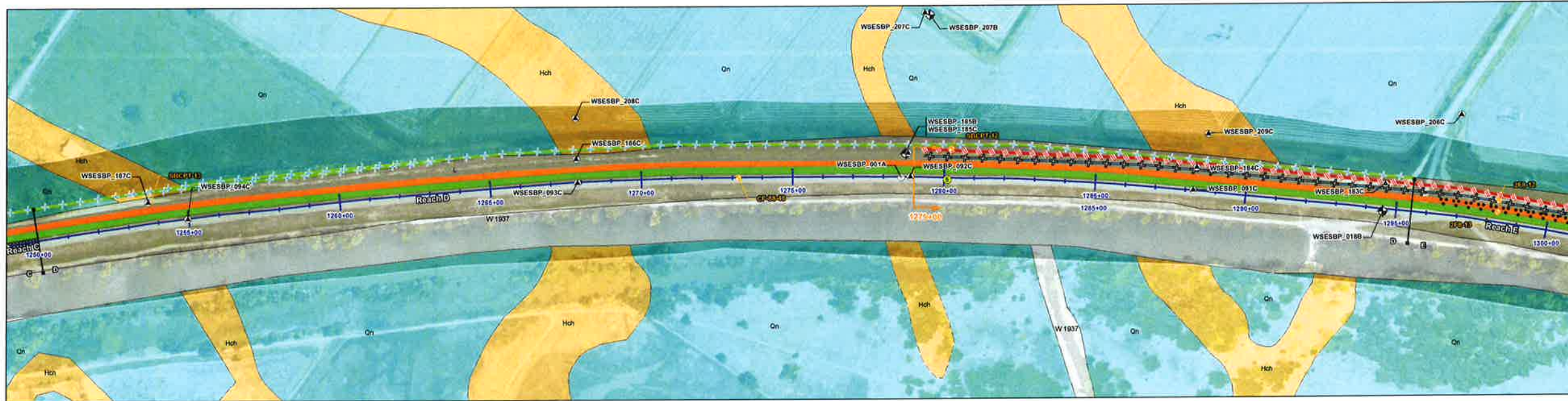

- NOTES:
1. Elevations of levee crown, landside toe, and landside depression/ditch are approximate.
 2. Stratigraphy between explorations may differ from that shown at exploration locations.
 3. Only explorations through the levee crown are shown on the profile.
 4. Historical borings on the profile are denoted by an asterisk (*) after the boring name. Historical boring locations and profiles are based on available information. Some historical explorations are shown on the plan but not in the profile if the log was not available or was close to a new exploration.
 5. USCS classification labels are not presented on the profiles for soil lenses (thickness less than 1.5 ft).
 6. This is a color figure. Black and white reproductions should not be relied upon as data will be lost.
 7. To prevent scale distortion, this map should be printed on a "D" size sheet (22x34 inches).
 8. Surficial geology was mapped at 1:20,000.

NO BATHYMETRY

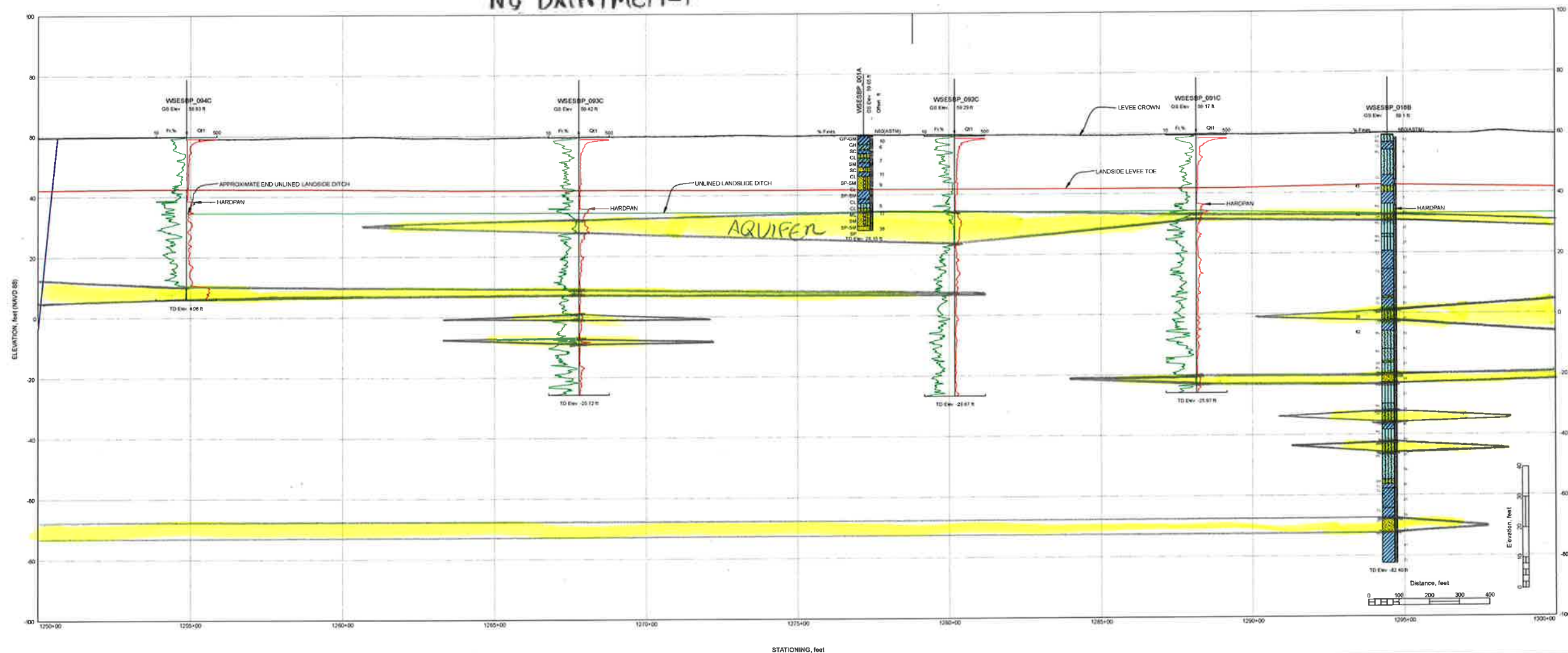

DETAIL AREA

- Legend
- Urban Project Levee
 - Plate Location

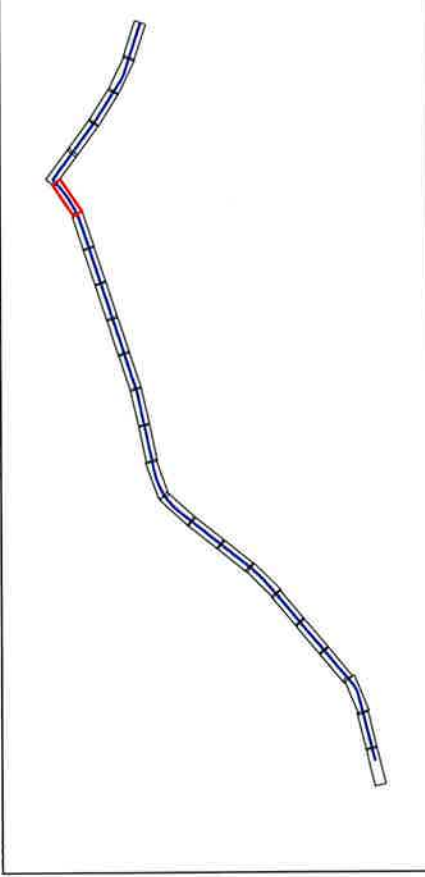

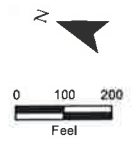
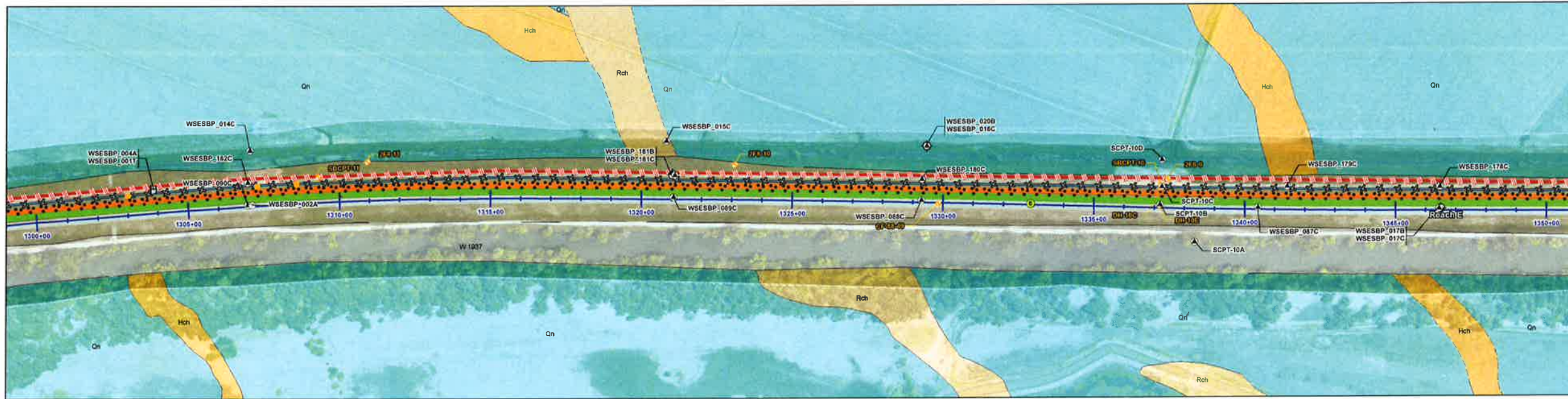

- NOTES:
- Elevations of levee crown, landside toe, and landside depression/ditch are approximate.
 - Stratigraphy between explorations may differ from that shown at exploration locations.
 - Only explorations through the levee crown are shown on the profile.
 - Historical borings on the profile are denoted by an asterisk (*) after the boring name. Historical boring locations and profiles are based on available information. Some historical explorations are shown on the plan but not in the profile if the log was not available or was close to a new exploration.
 - USCS classification labels are not presented on the profiles for soil lenses (thickness less than 1.5 ft).
 - This is a color figure. Black and white reproductions should not be relied upon as data will be lost.
 - To prevent scale distortion, this map should be printed on a "D" size sheet (22x34 inches).
 - Surficial geology was mapped at 1:20,000.

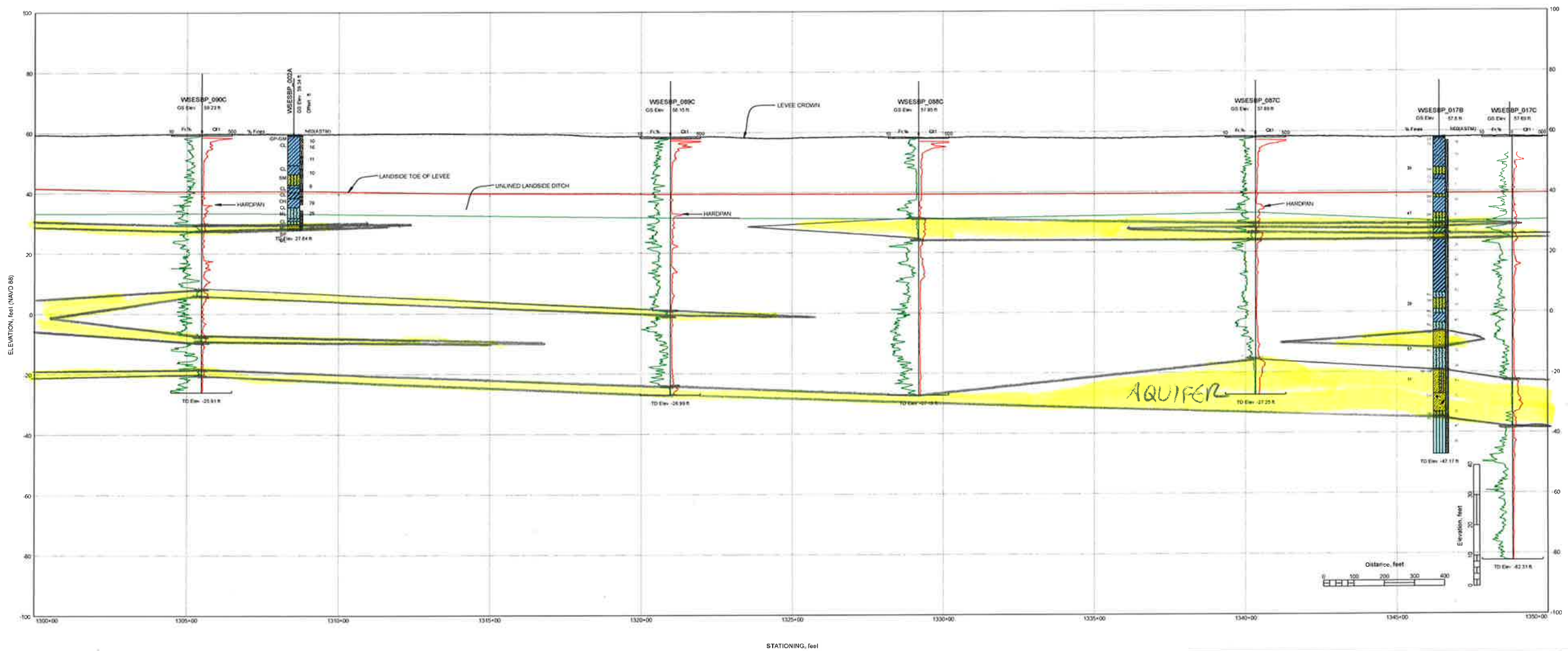

DETAIL AREA

- Legend
- Urban Project Levee
 - Plate Location

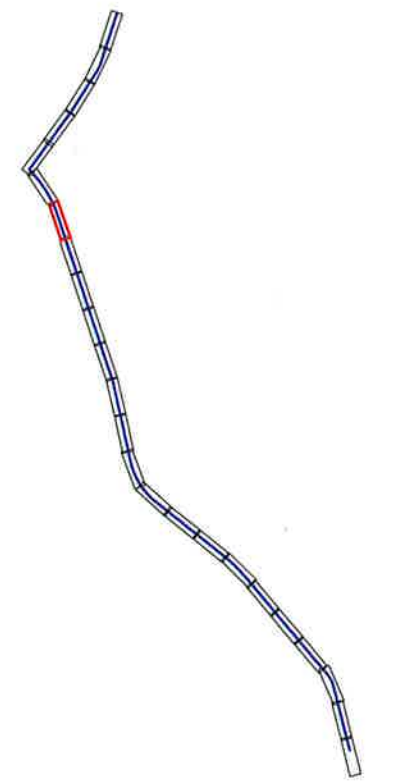

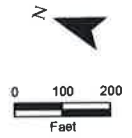
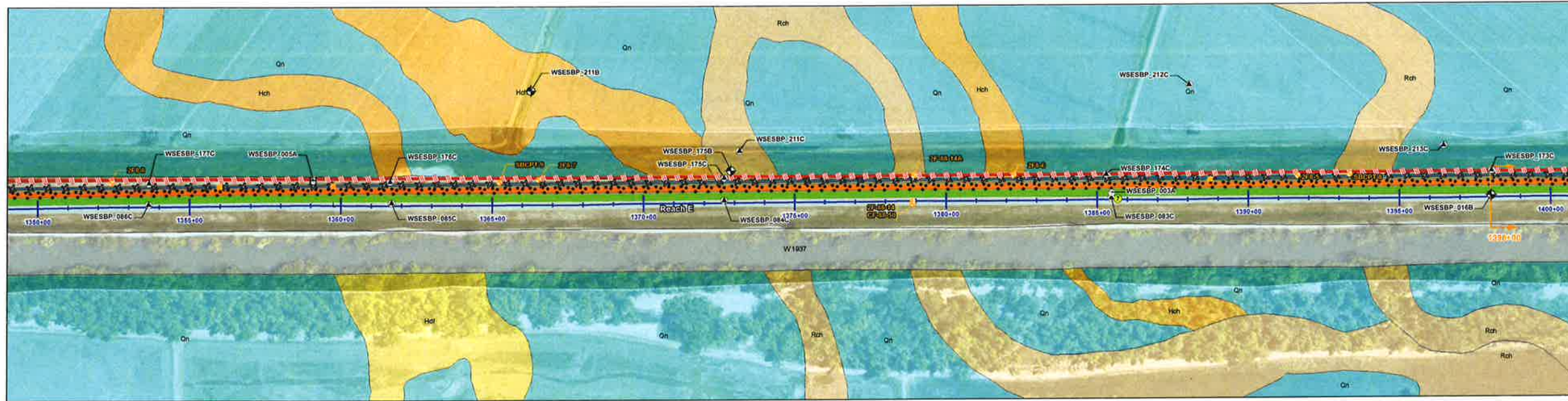

- NOTES:
- Elevations of levee crown, landside toe, and landside depression/ditch are approximate.
 - Stratigraphy between explorations may differ from that shown at exploration locations.
 - Only explorations through the levee crown are shown on the profile.
 - Historical borings on the profile are denoted by an asterisk (*) after the boring name. Historical boring locations and profiles are based on available information. Some historical explorations are shown on the plan but not in the profile if the log was not available or was close to a new exploration.
 - USCS classification labels are not presented on the profiles for soil lenses (thickness less than 1.5 ft).
 - This is a color figure. Black and white reproductions should not be relied upon as data will be lost.
 - To prevent scale distortion, this map should be printed on a "D" size sheet (22x34 inches).
 - Surficial geology was mapped at 1:20,000.

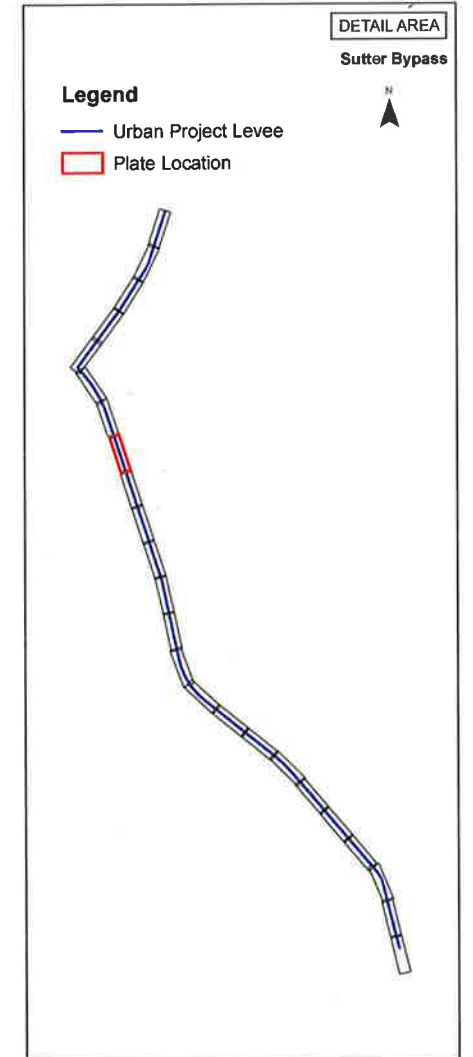
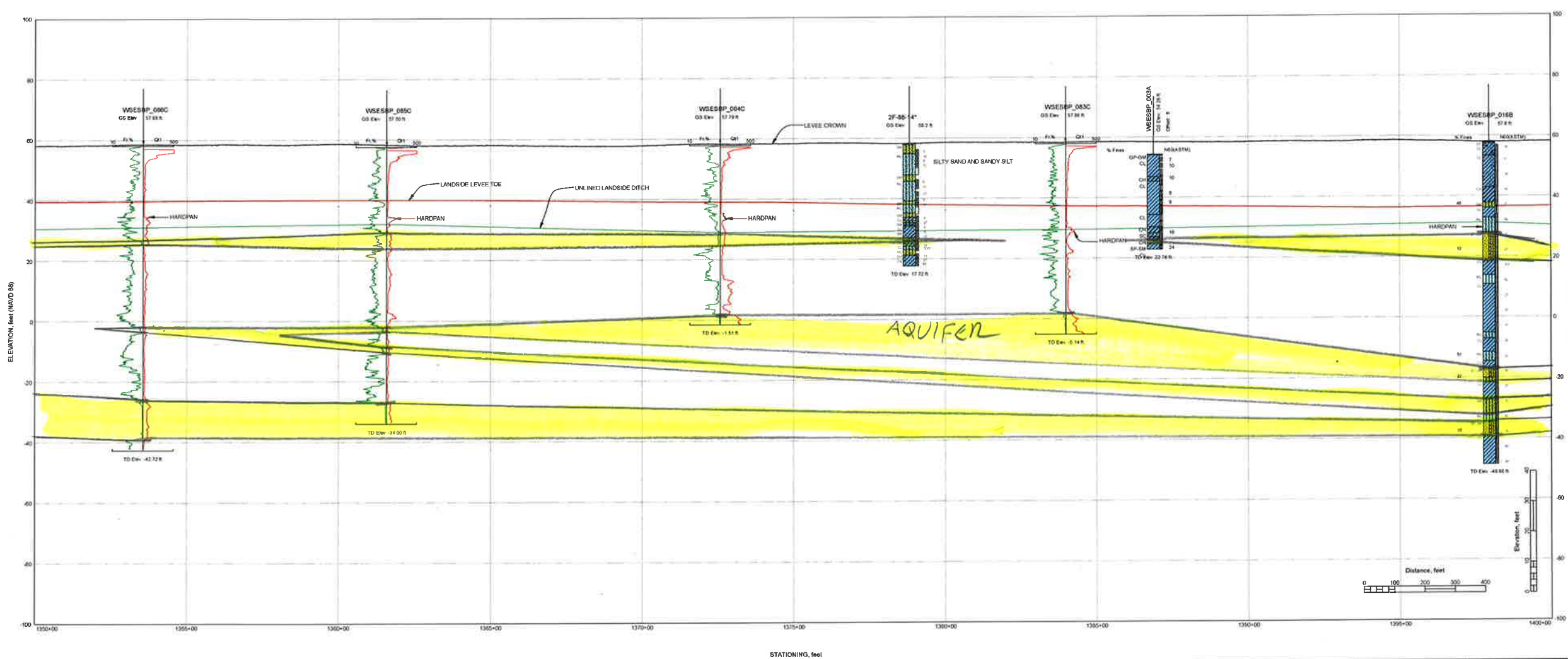

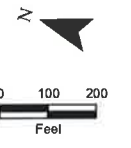
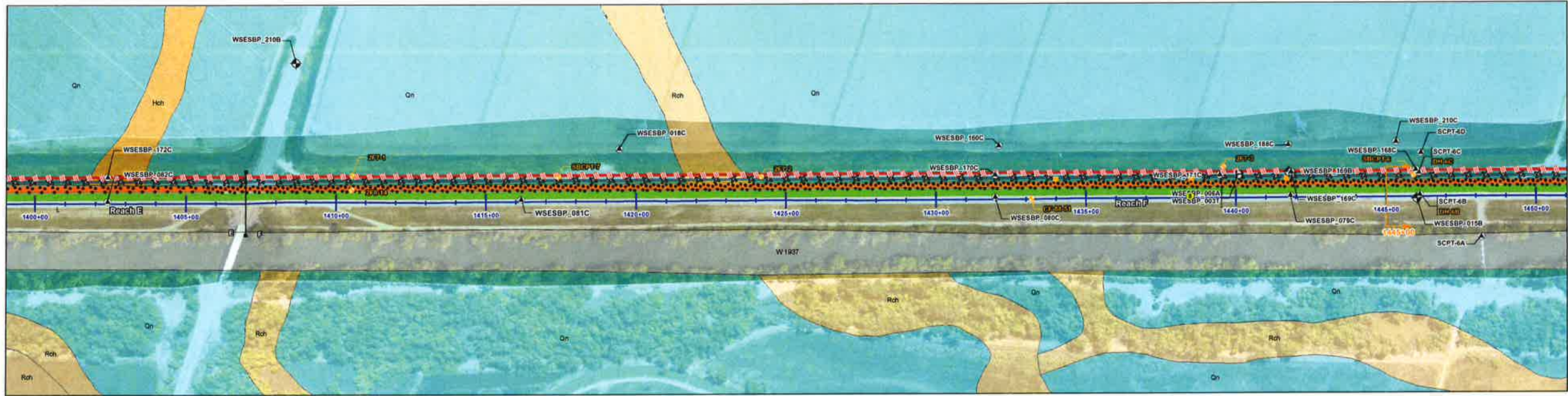

- NOTES:
1. Elevations of levee crown, landside toe, and landside depression/ditch are approximate.
 2. Stratigraphy between explorations may differ from that shown at exploration locations.
 3. Only explorations through the levea crown are shown on the profile.
 4. Historical borings on the profile are denoted by an asterisk (*) after the boring name. Historical boring locations and profiles are based on available information. Some historical explorations are shown on the plan but not in the profile if the log was not available or was close to a new exploration.
 5. USCS classification labels are not presented on the profiles for soil lenses (thickness less than 1.5 ft).
 6. This is a color figure. Black and white reproductions should not be relied upon as data will be lost.
 7. To prevent scale distortion, this map should be printed on a "D" size sheet (22x34 inches).
 8. Surficial geology was mapped at 1:20,000.

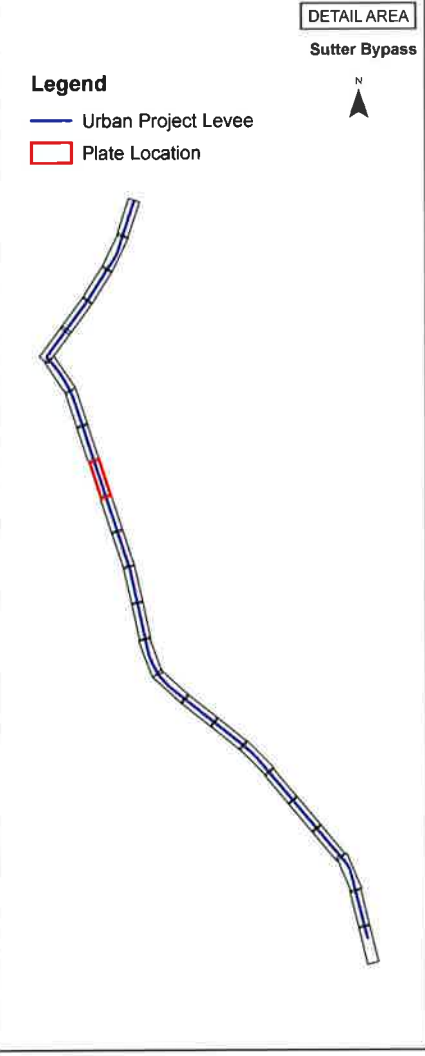
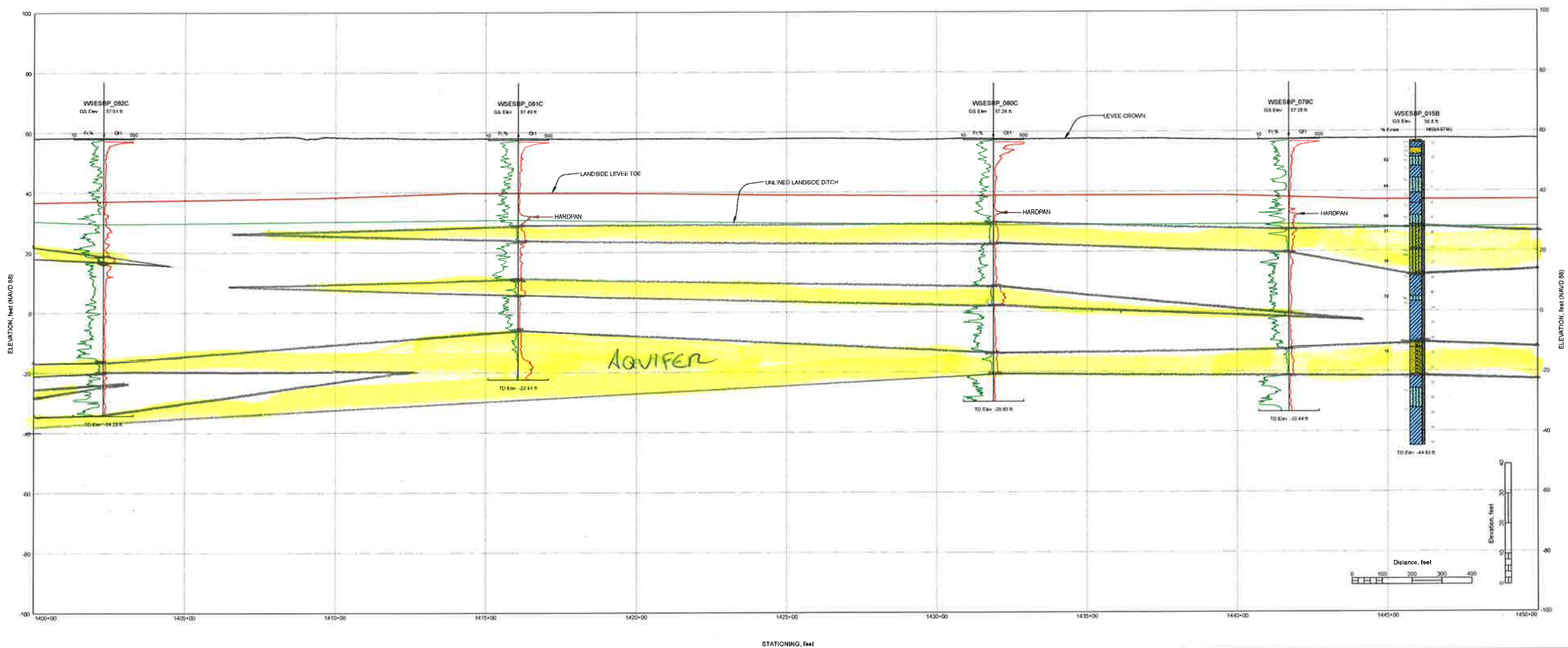

U:\Projects\2010\1000\SUTTER_BYPASS\GIS\GEO\GEOLOGICAL\GEOLOGICAL_PROFILE_11.dwg

Geotechnical Evaluation Report

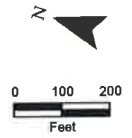
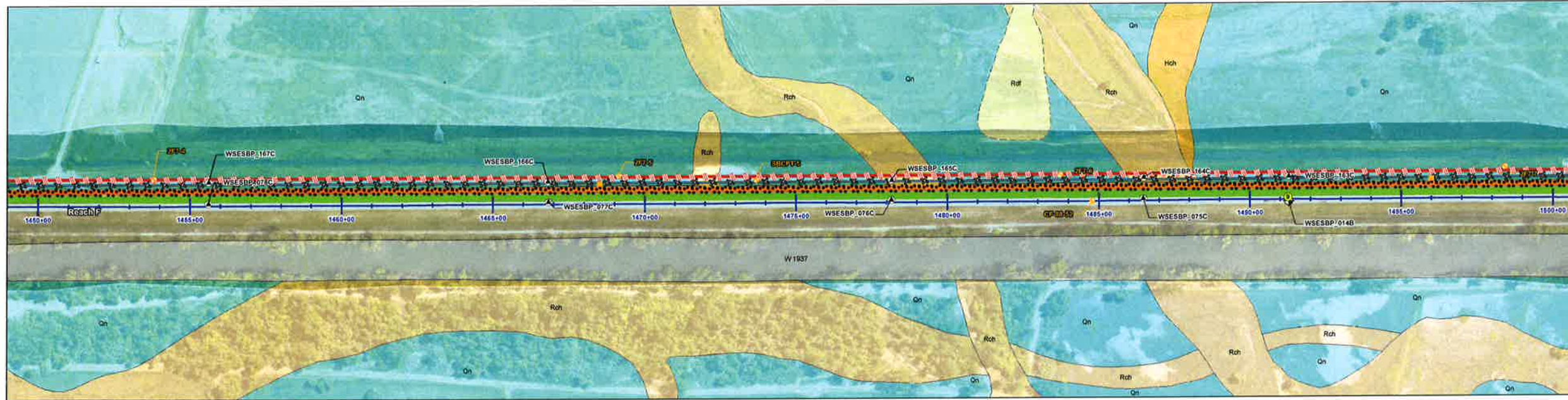

- NOTES:
1. Elevations of levee crown, landside toe, and landside depression/ditch are approximate.
 2. Stratigraphy between explorations may differ from that shown at exploration locations.
 3. Only explorations through the levee crown are shown on the profile.
 4. Historical borings on the profile are denoted by an asterisk (*) after the boring name. Historical boring locations and profiles are based on available information. Some historical explorations are shown on the plan but not in the profile if the log was not available or was close to a new exploration.
 5. USCS classification labels are not presented on the profiles for soil lenses (thickness less than 1.5 ft).
 6. This is a color figure. Black and white reproductions should not be relied upon as data will be lost.
 7. To prevent scale distortion, this map should be printed on a "D" size sheet (22x34 inches).
 8. Surficial geology was mapped at 1:20,000.

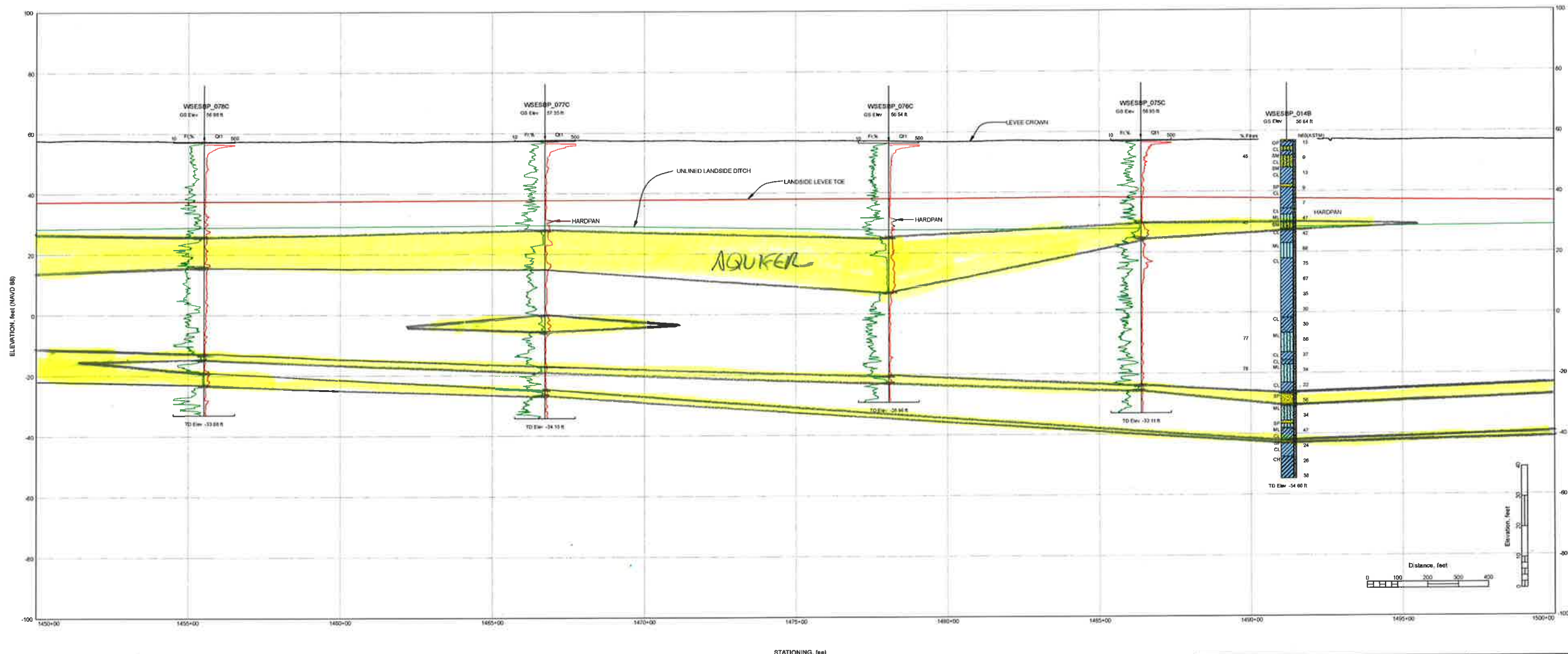

DETAIL AREA

Sutter Bypass

- Legend
- Urban Project Levee
 - Plate Location

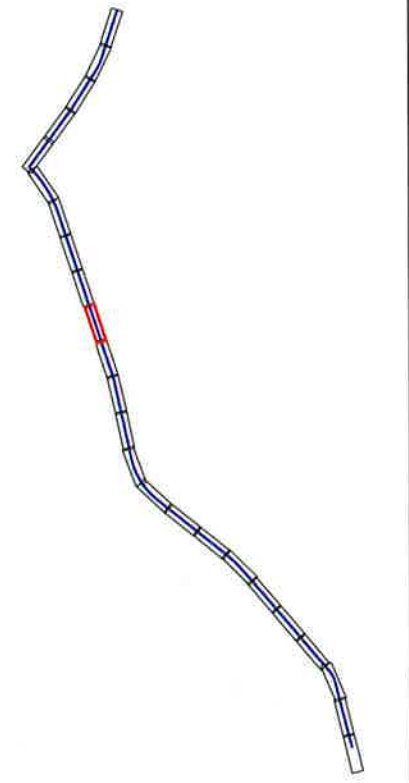

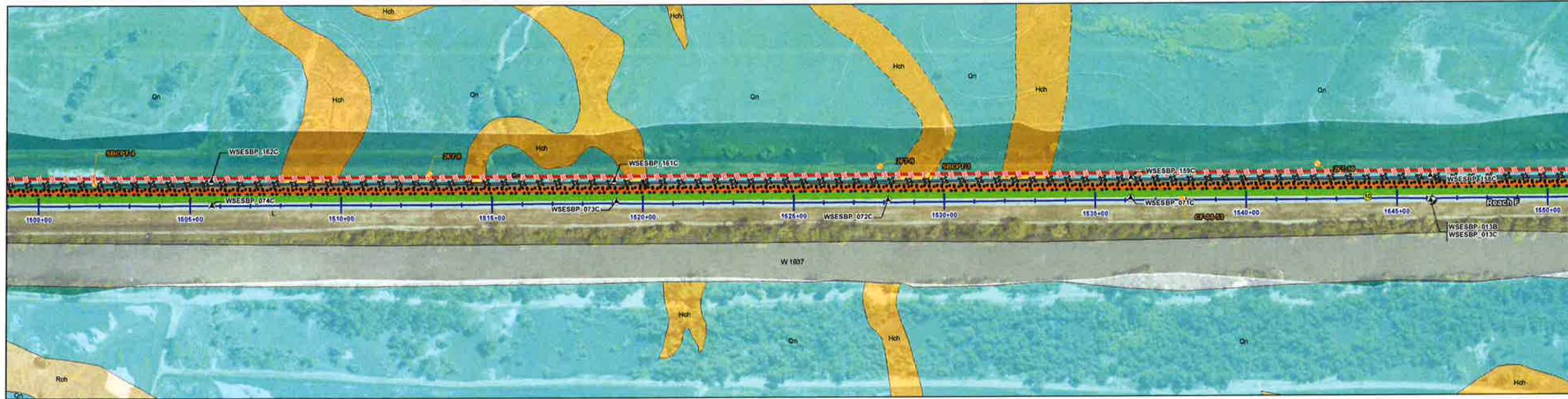

NOTES:

1. Elevations of levee crown, landside toe, and landside depression/ditch are approximate.
2. Stratigraphy between explorations may differ from that shown at exploration locations.
3. Only explorations through the levee crown are shown on the profile.
4. Historical borings on the profile are denoted by an asterisk (*) after the boring name. Historical boring locations and profiles are based on available information. Some historical explorations are shown on the plan but not in the profile if the log was not available or was close to a new exploration.
5. USCS classification labels are not presented on the profiles for soil lenses (thickness less than 1.5 ft).
6. This is a color figure. Black and white reproductions should not be relied upon as data will be lost.
7. To prevent scale distortion, this map should be printed on a 'D' size sheet (22x34 inches).
8. Surficial geology was mapped at 1:20,000.

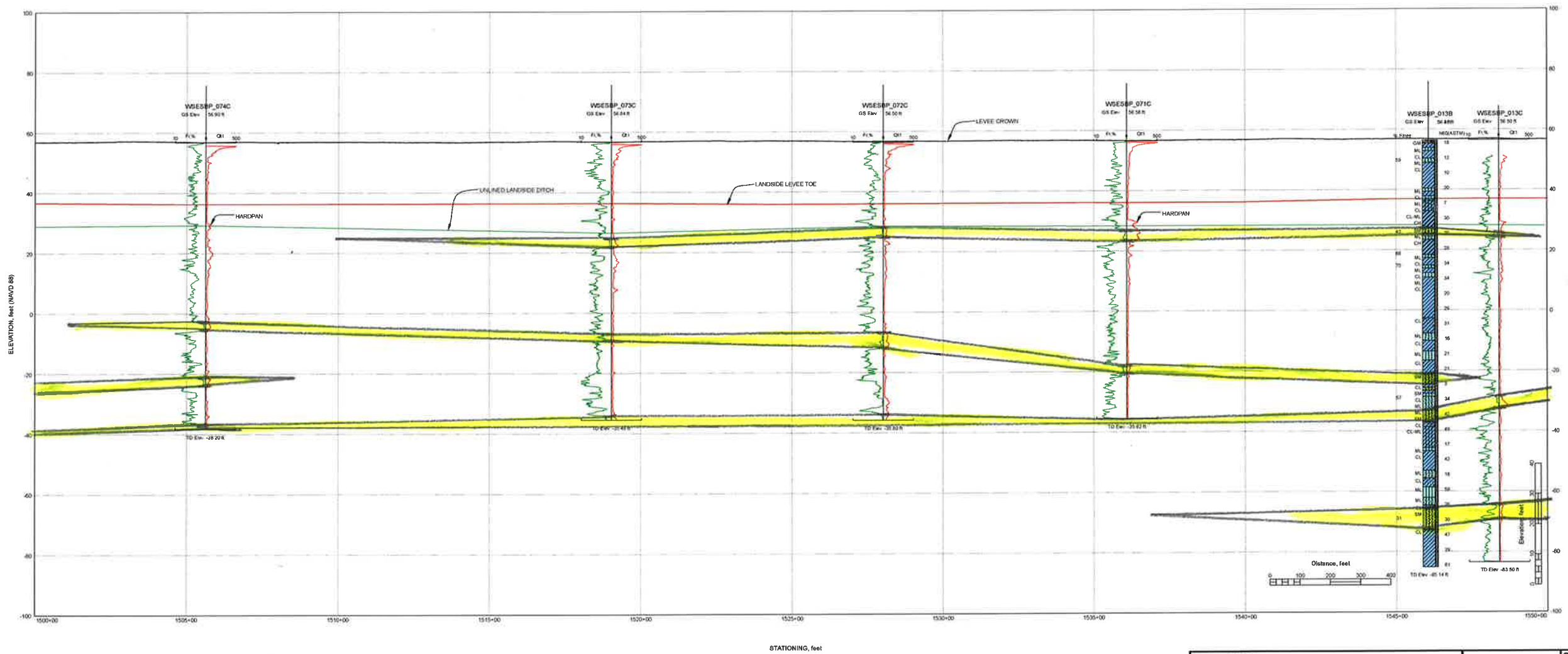

DETAIL AREA

Sutter Bypass

Legend

- Urban Project Levee
- Plate Location

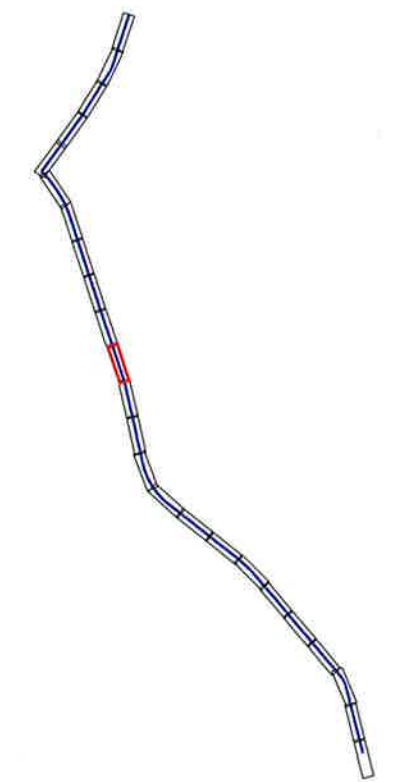

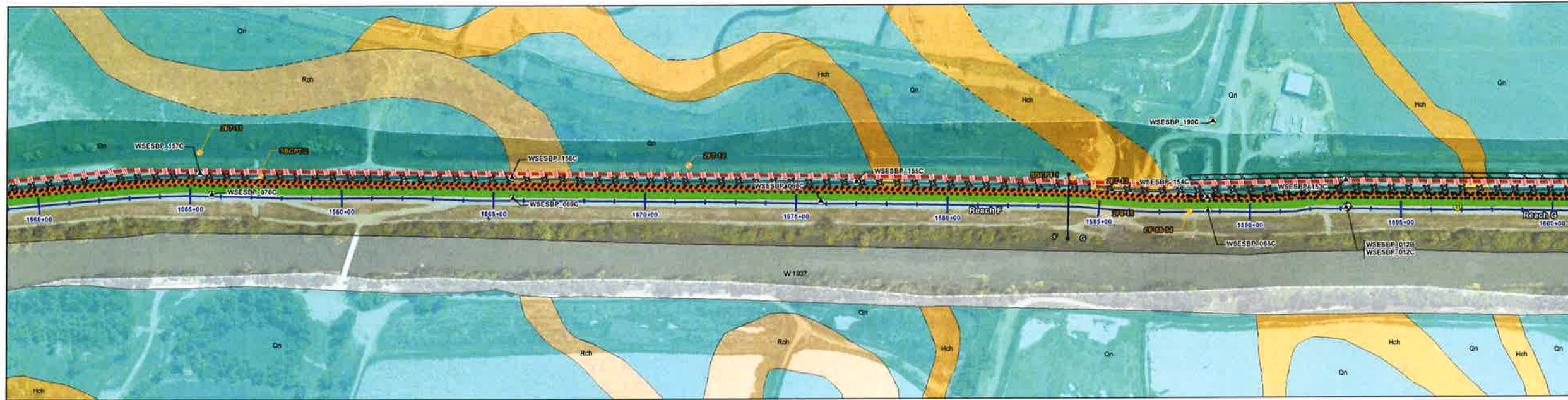

N

0 100 200
Feet

NOTES:

- Elevations of levee crown, landside toe, and landside depression/ditch are approximate.
- Stratigraphy between explorations may differ from that shown at exploration locations.
- Only explorations through the levee crown are shown on the profile.
- Historical borings on the profile are denoted by an asterisk (*) after the boring name. Historical boring locations and profiles are based on available information. Some historical explorations are shown on the plan but not in the profile if the log was not available or was close to a new exploration.
- USCS classification labels are not presented on the profiles for soil lenses (thickness less than 1.5 ft).
- This is a color figure. Black and white reproductions should not be relied upon as data will be lost.
- To prevent scale distortion, this map should be printed on a "D" size sheet (22x34 inches).
- Surficial geology was mapped at 1:20,000.

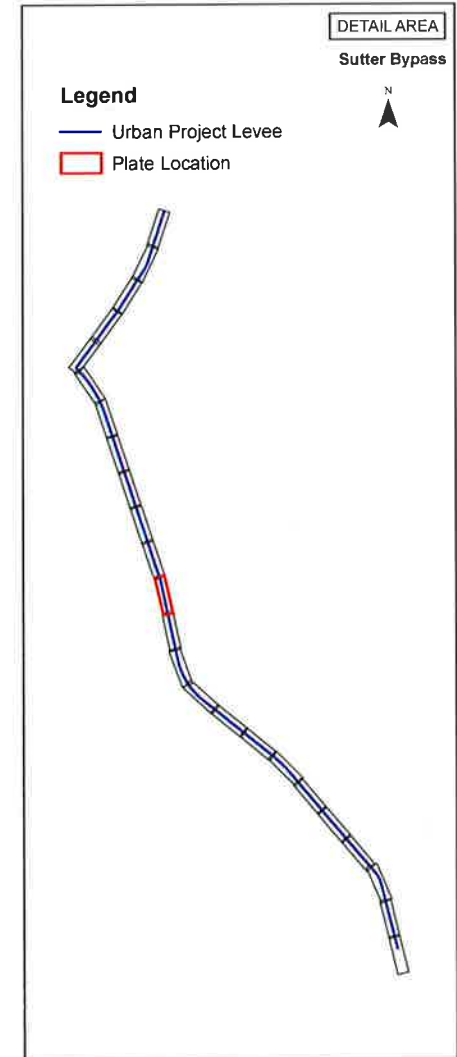
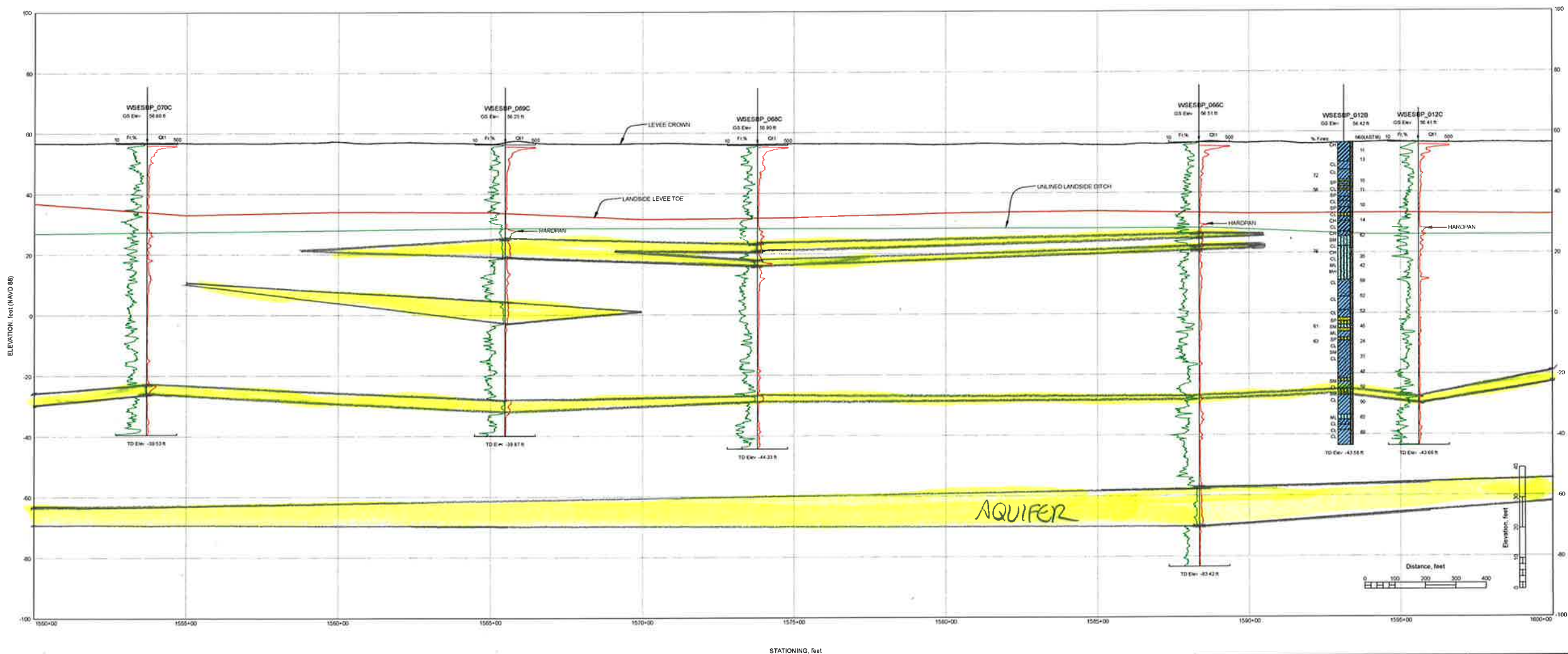

L:\projects\2014\2014_SutterBypass\GIS\141103C_SUTTER_BYPASS\WADSWORTH_CANAL\GEO\GEOEVAL\GEOEVAL_Plate 14.dwg

Geotechnical Evaluation Report

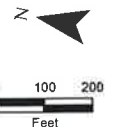
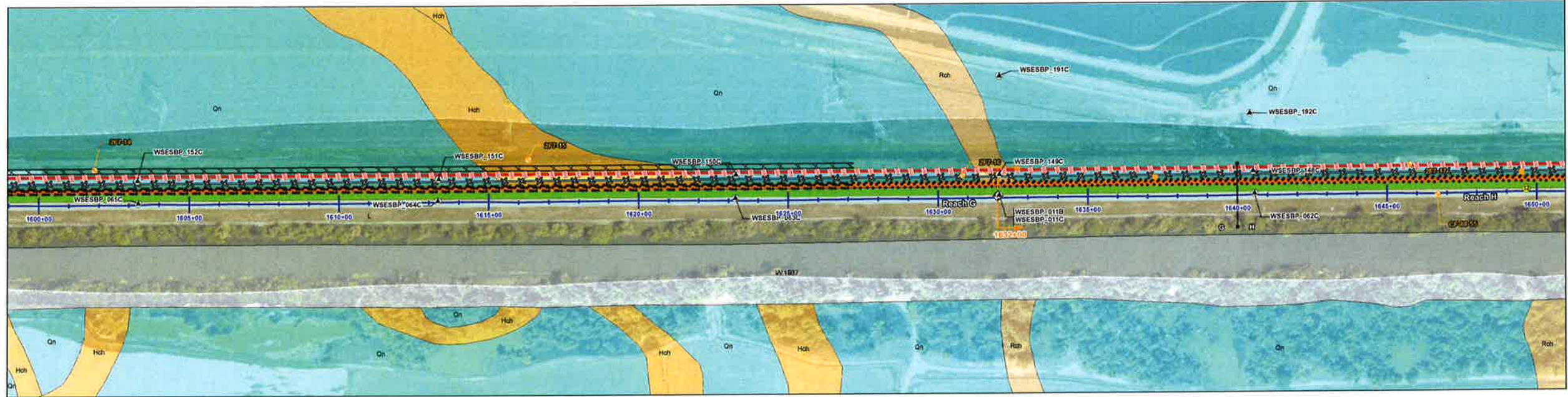

- NOTES:
1. Elevations of levee crown, landside toe, and landside depression/ditch are approximate.
 2. Stratigraphy between explorations may differ from that shown at exploration locations.
 3. Only explorations through the levee crown are shown on the profile.
 4. Historical borings on the profile are denoted by an asterisk (*) after the boring name. Historical boring locations and profiles are based on available information. Some historical explorations are shown on the plan but not in the profile if the log was not available or was close to a new exploration.
 5. USCS classification labels are not presented on the profiles for soil lenses (thickness less than 1.5 ft).
 6. This is a color figure. Black and white reproductions should not be relied upon as data will be lost.
 7. To prevent scale distortion, this map should be printed on a "D" size sheet (22x34 inches).
 8. Surficial geology was mapped at 1:20,000.

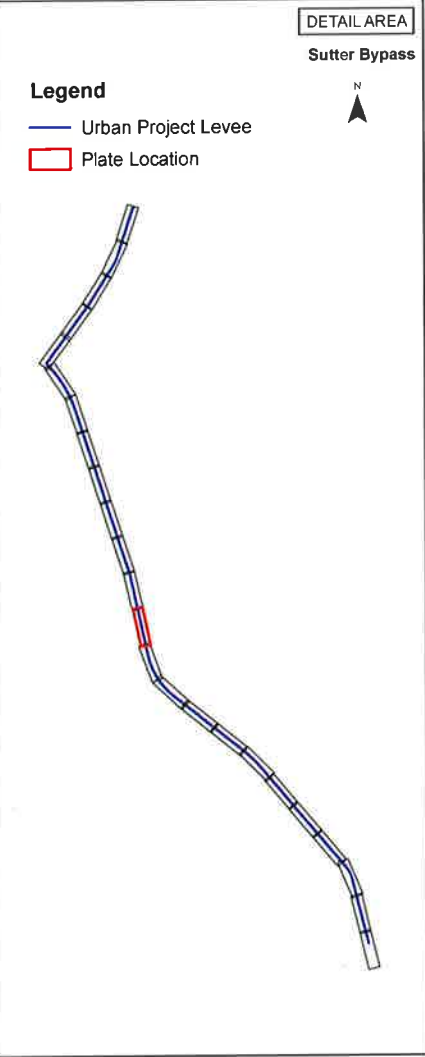
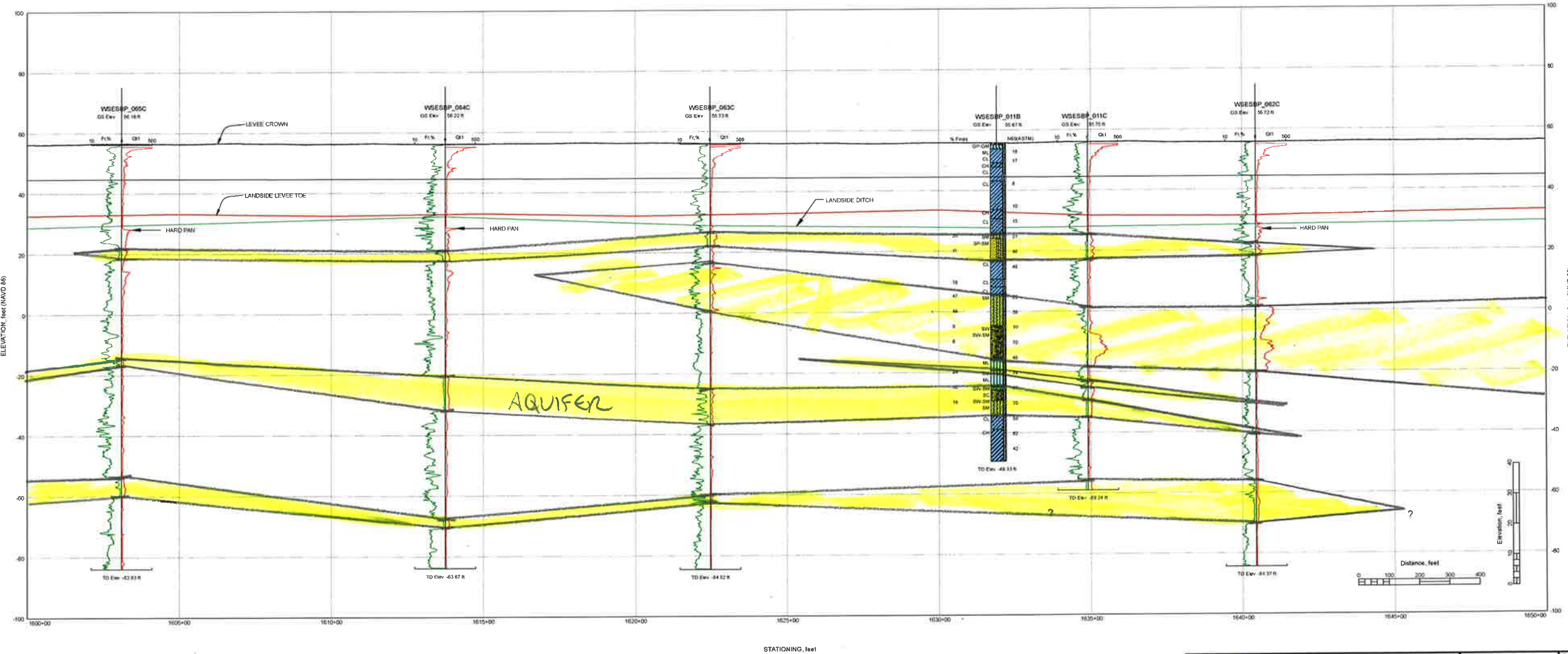

C:\Users\jmcott\Documents\Projects\Sutter Bypass\Drawings\Profile\Plate 15.dwg

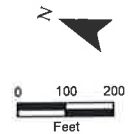
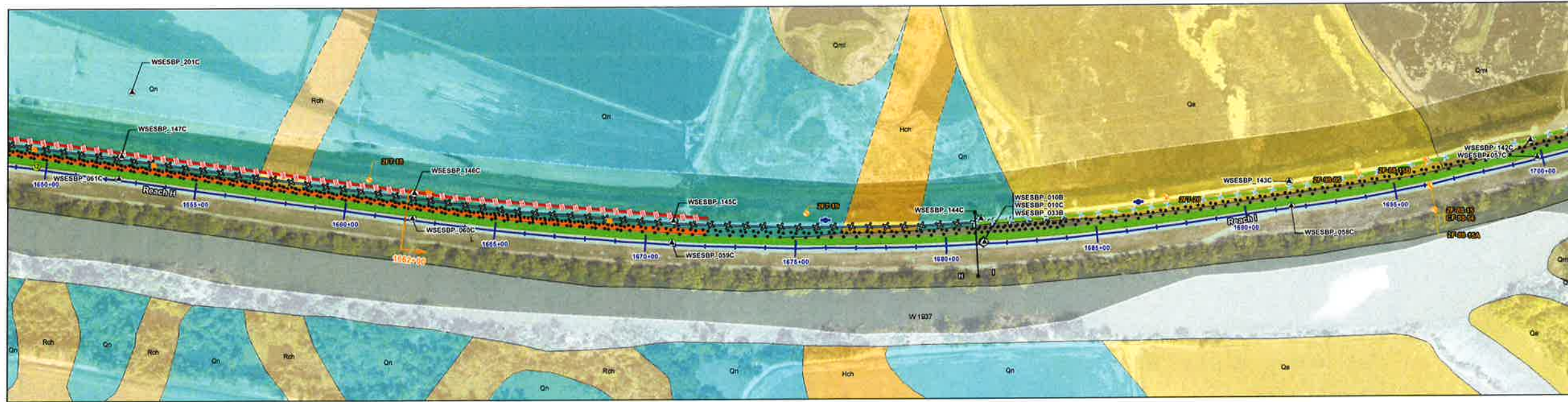

- NOTES:
1. Elevations of levee crown, landside toe, and landside depression/ditch are approximate.
 2. Stratigraphy between explorations may differ from that shown at exploration locations.
 3. Only explorations through the levee crown are shown on the profile.
 4. Historical borings on the profile are denoted by an asterisk (*) after the boring name. Historical boring locations and profiles are based on available information. Some historical explorations are shown on the plan but not in the profile if the log was not available or was close to a new exploration.
 5. USCS classification labels are not presented on the profiles for soil lenses (thickness less than 1.5 ft).
 6. This is a color figure. Black and white reproductions should not be relied upon as data will be lost.
 7. To prevent scale distortion, this map should be printed on a "D" size sheet (22x34 inches).
 8. Surficial geology was mapped at 1:20,000.

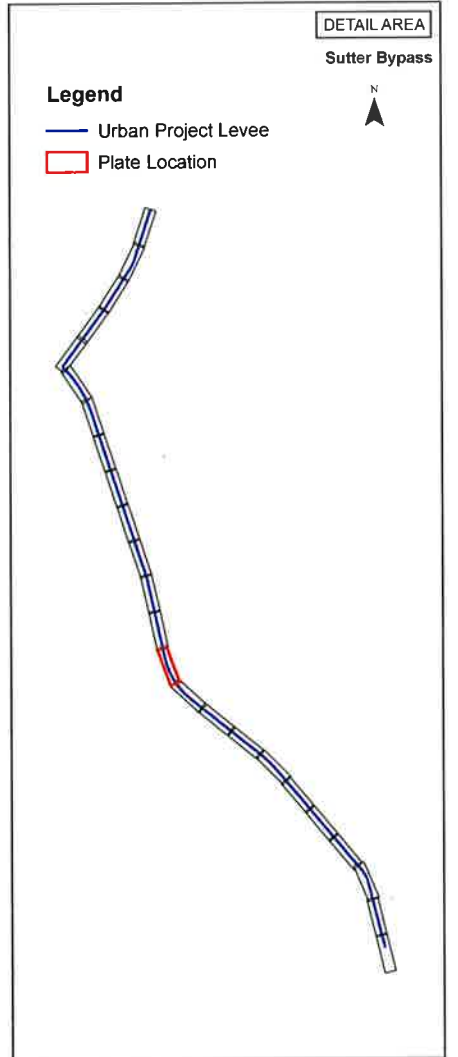
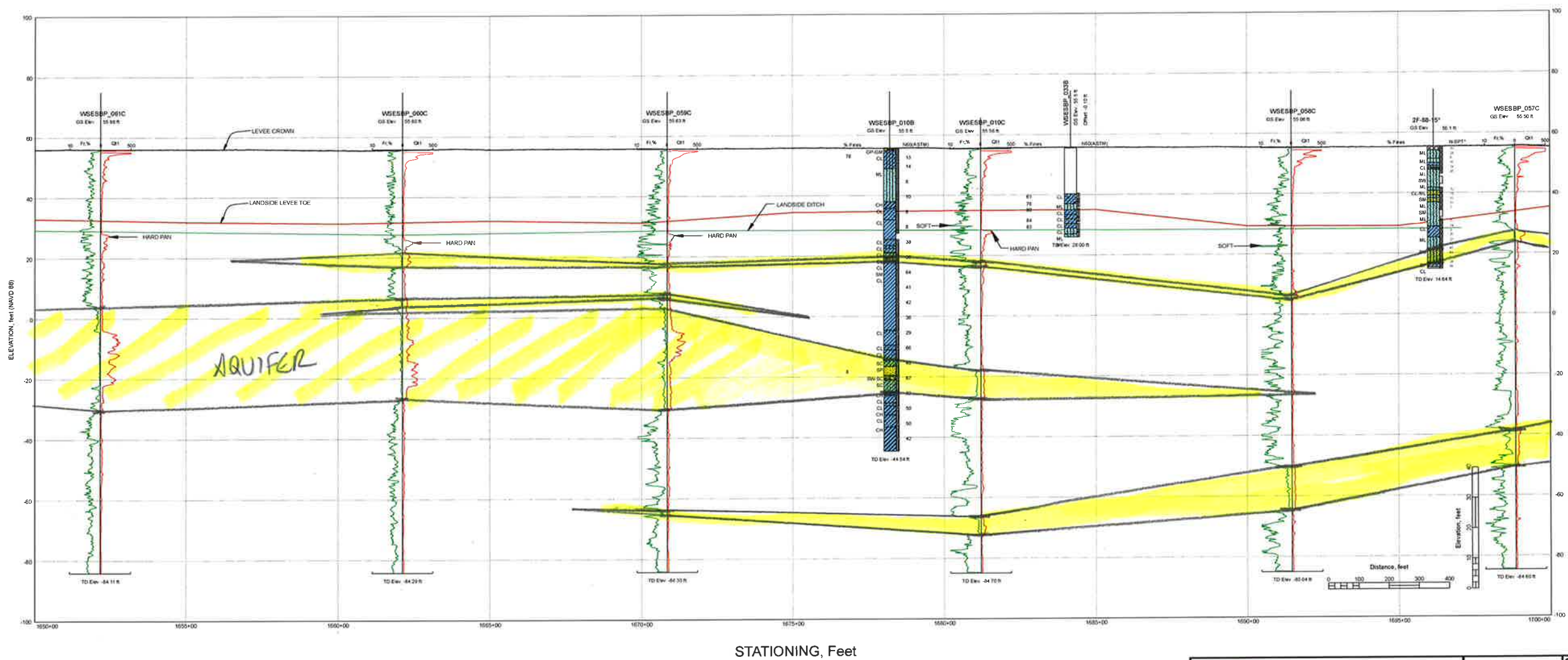

STATIONING, Feet

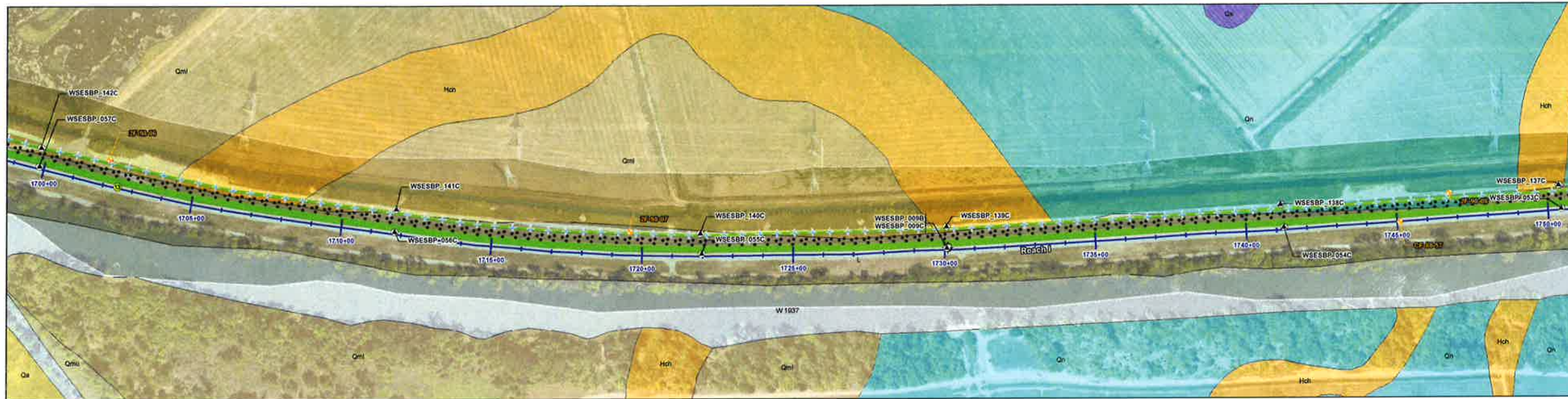

- NOTES:
1. Elevations of levee crown, landside toe, and landside depression/ditch are approximate.
 2. Stratigraphy between explorations may differ from that shown at exploration locations.
 3. Only explorations through the levee crown are shown on the profile.
 4. Historical borings on the profile are denoted by an asterisk (*) after the boring name. Historical boring locations and profiles are based on available information. Some historical explorations are shown on the plan but not in the profile if the log was not available or was close to a new exploration.
 5. USCS classification labels are not presented on the profiles for soil lenses (thickness less than 1.5 ft).
 6. This is a color figure. Black and white reproductions should not be relied upon as data will be lost.
 7. To prevent scale distortion, this map should be printed on a "D" size sheet (22x34 inches).
 8. Surficial geology was mapped at 1:20,000.

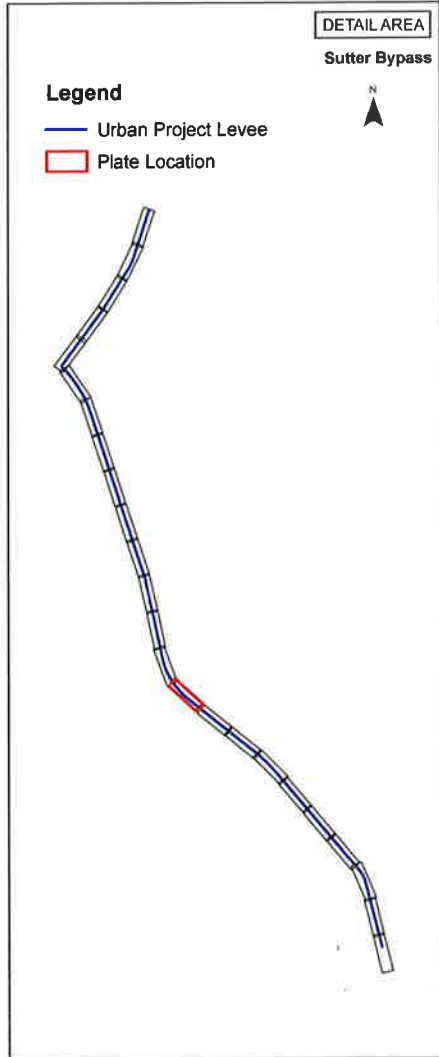
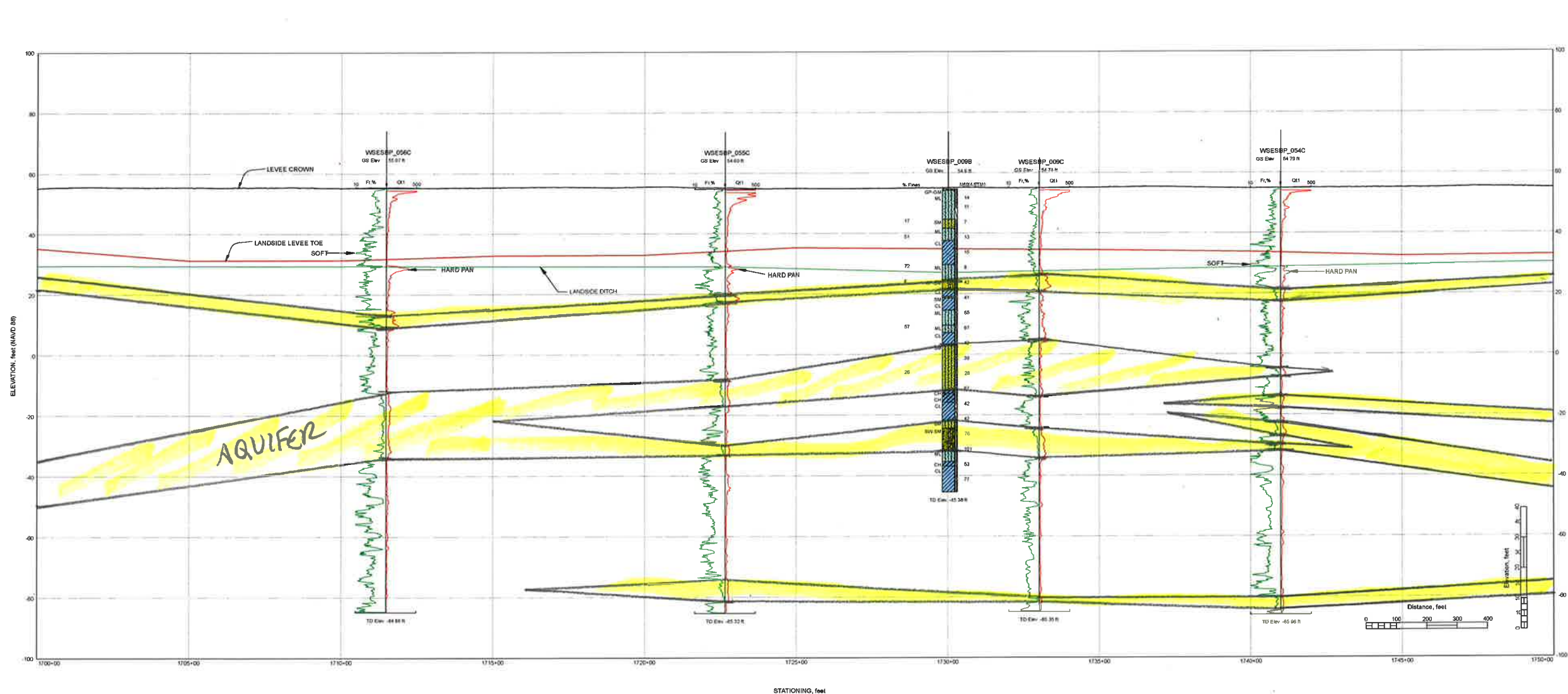

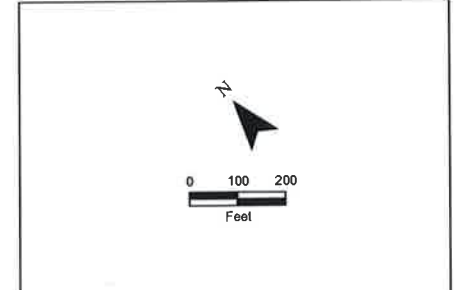
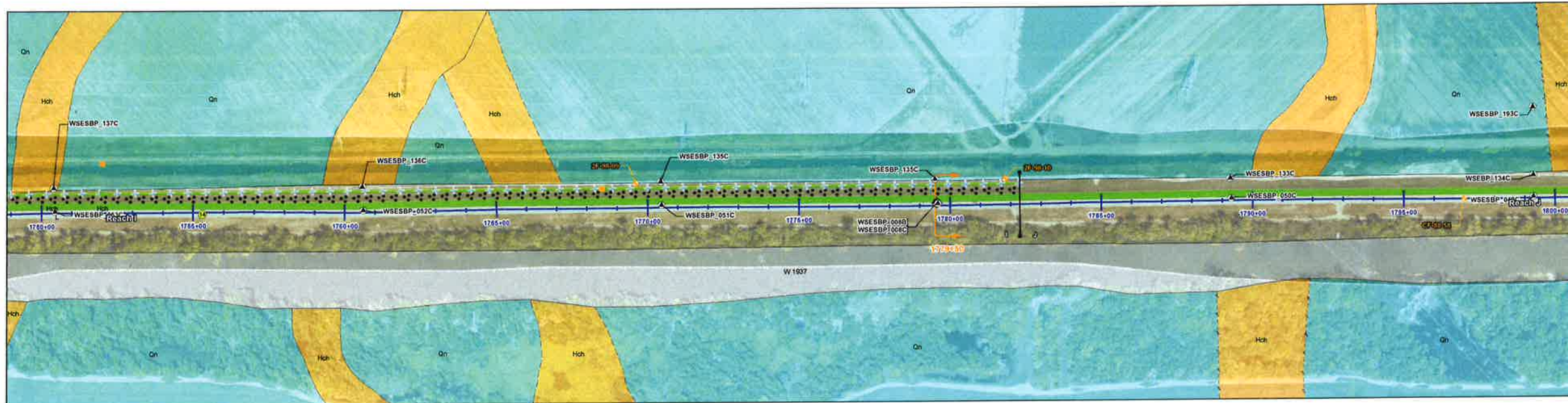

- NOTES:
1. Elevations of levee crown, landside toe, and landside depression/ditch are approximate.
 2. Stratigraphy between explorations may differ from that shown at exploration locations.
 3. Only explorations through the levee crown are shown on the profile.
 4. Historical borings on the profile are denoted by an asterisk (*) after the boring name. Historical boring locations and profiles are based on available information. Some historical explorations are shown on the plan but not in the profile if the log was not available or was close to a new exploration.
 5. USCS classification labels are not presented on the profiles for soil lenses (thickness less than 1.5 ft).
 6. This is a color figure. Black and white reproductions should not be relied upon as data will be lost.
 7. To prevent scale distortion, this map should be printed on a "D" size sheet (22x34 inches).
 8. Surficial geology was mapped at 1:20,000.

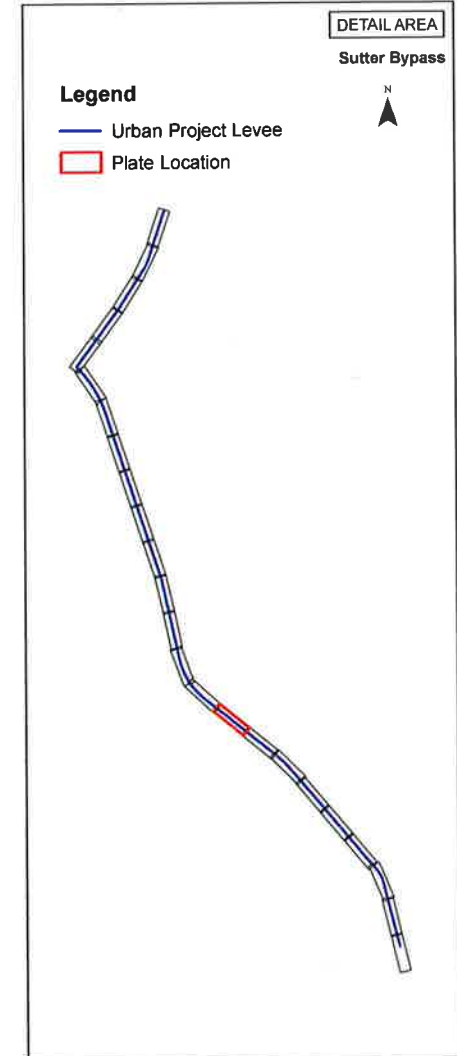
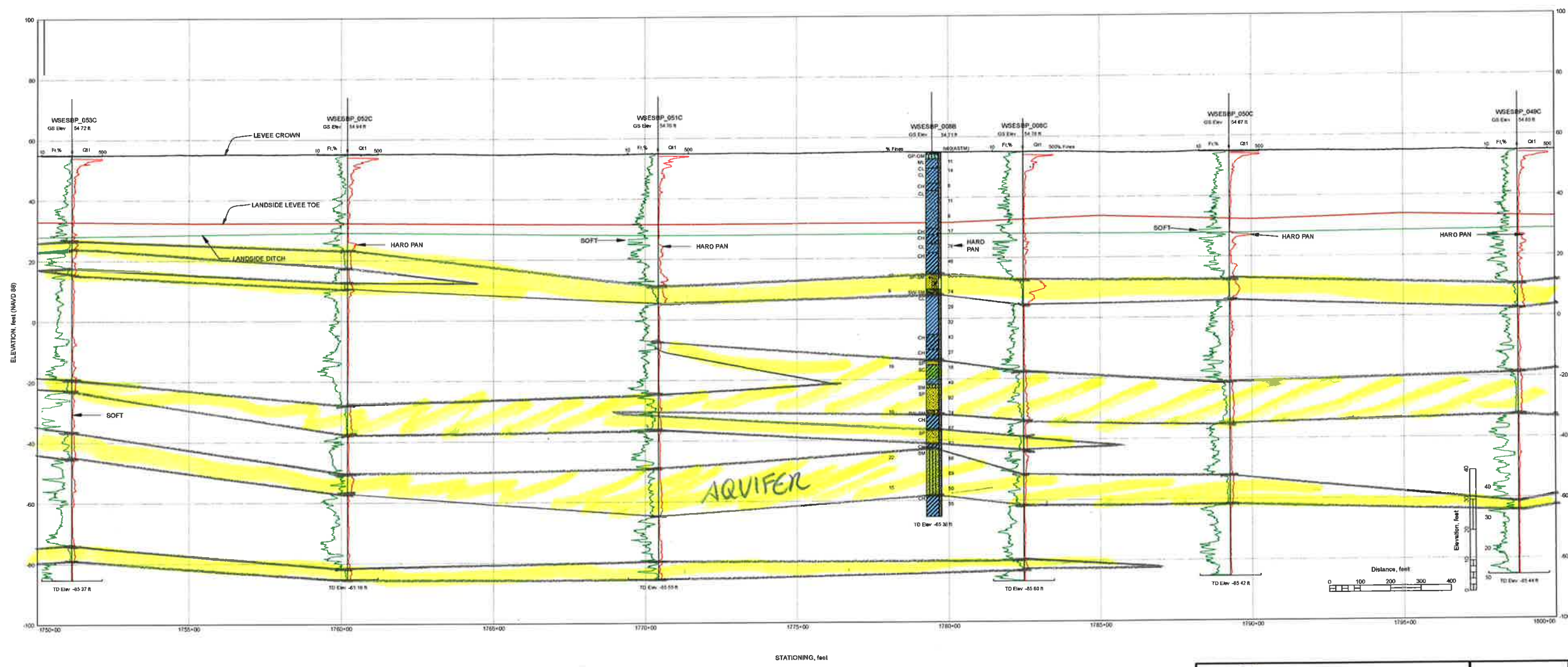

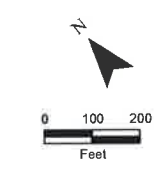
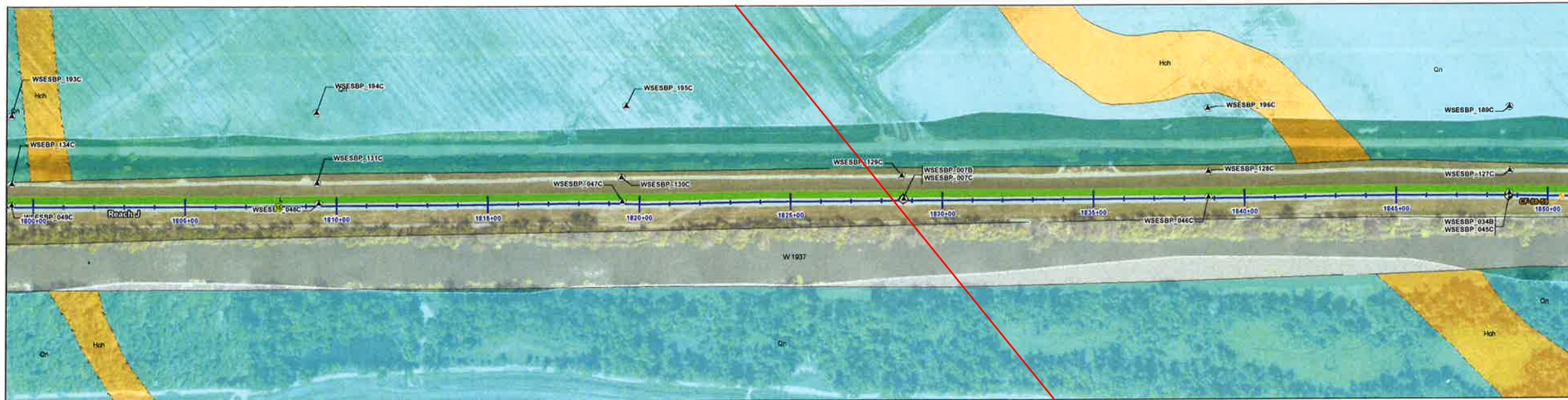

- NOTES:
- Elevations of levee crown, landside toe, and landside depression/ditch are approximate.
 - Stratigraphy between explorations may differ from that shown at exploration locations.
 - Only explorations through the levee crown are shown on the profile.
 - Historical borings on the profile are denoted by an asterisk (*) after the boring name. Historical boring locations and profiles are based on available information. Some historical explorations are shown on the plan but not in the profile if the log was not available or was close to a new exploration.
 - USCS classification labels are not presented on the profiles for soil lenses (thickness less than 1.5 ft).
 - This is a color figure. Black and white reproductions should not be relied upon as data will be lost.
 - To prevent scale distortion, this map should be printed on a "D" size sheet (22x34 inches).
 - Surficial geology was mapped at 1:20,000.

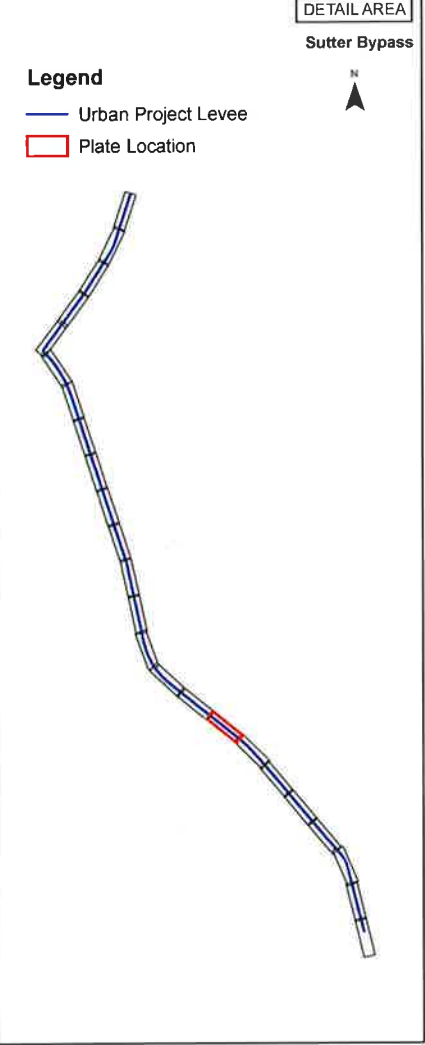
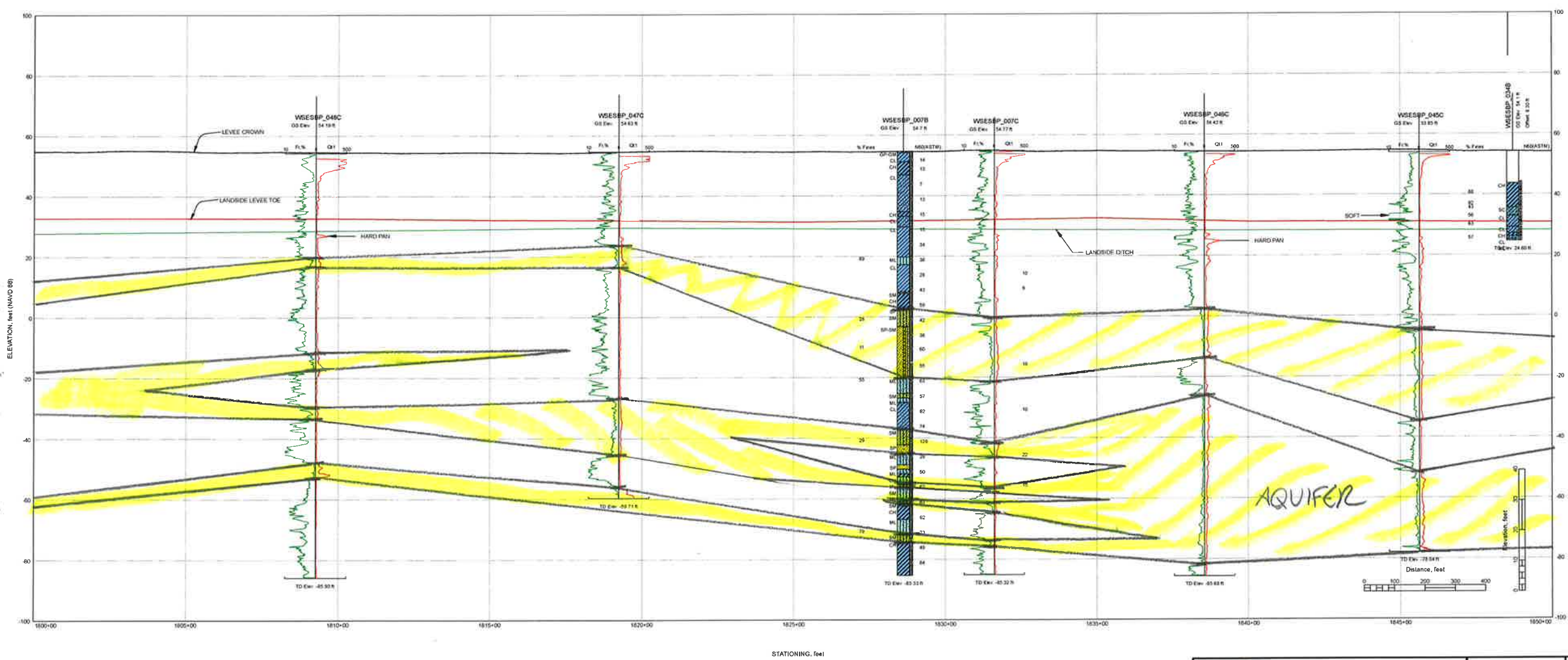

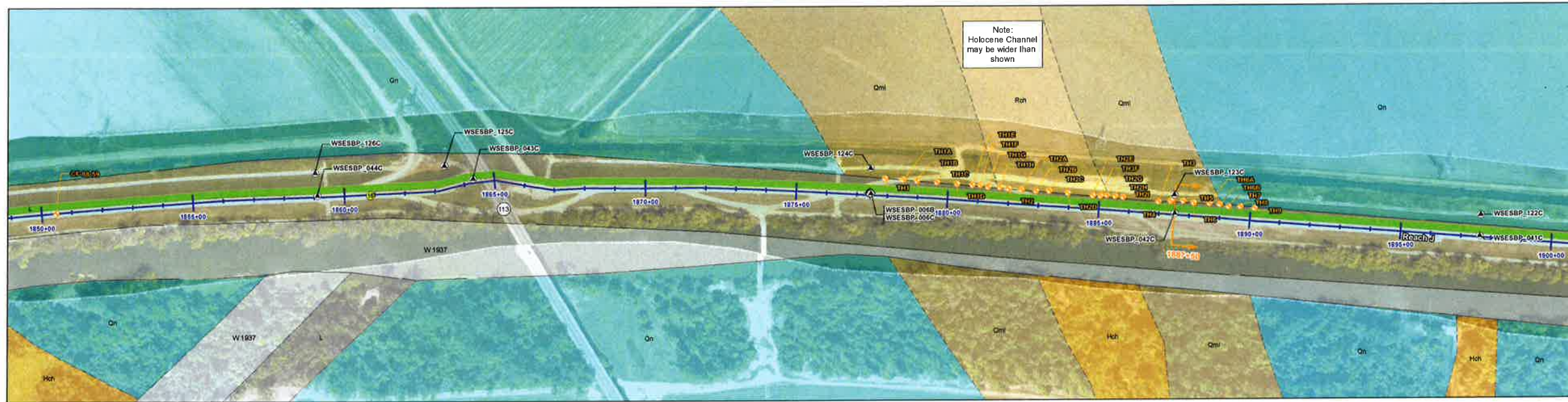

N
0 100 200
Feet

NOTES:

- Elevations of levee crown, landside toe, and landside depression/ditch are approximate.
- Stratigraphy between explorations may differ from that shown at exploration locations.
- Only explorations through the levee crown are shown on the profile.
- Historical borings on the profile are denoted by an asterisk (*) after the boring name. Historical boring locations and profiles are based on available information. Some historical explorations are shown on the plan but not in the profile if the log was not available or was close to a new exploration.
- USCS classification labels are not presented on the profiles for soil lenses (thickness less than 1.5 ft).
- This is a color figure. Black and white reproductions should not be relied upon as data will be lost.
- To prevent scale distortion, this map should be printed on a "D" size sheet (22x34 inches).
- Surficial geology was mapped at 1:20,000.

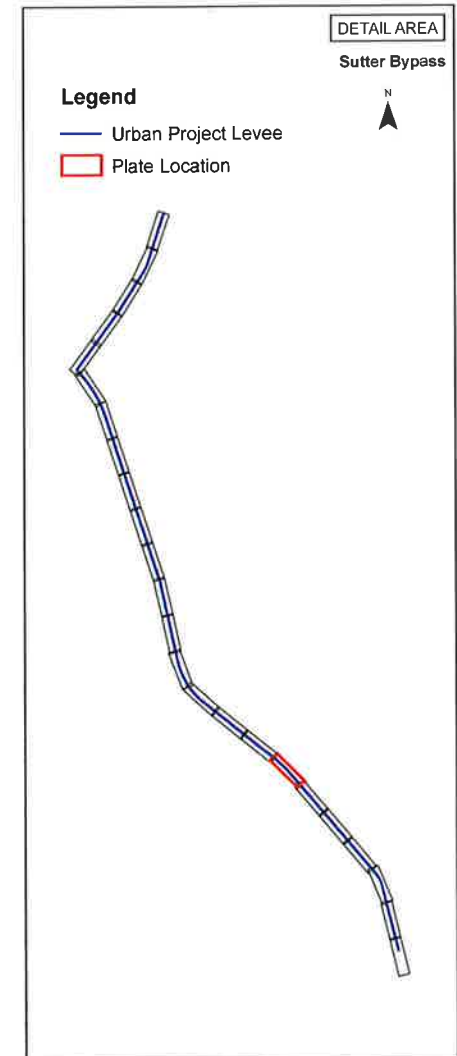
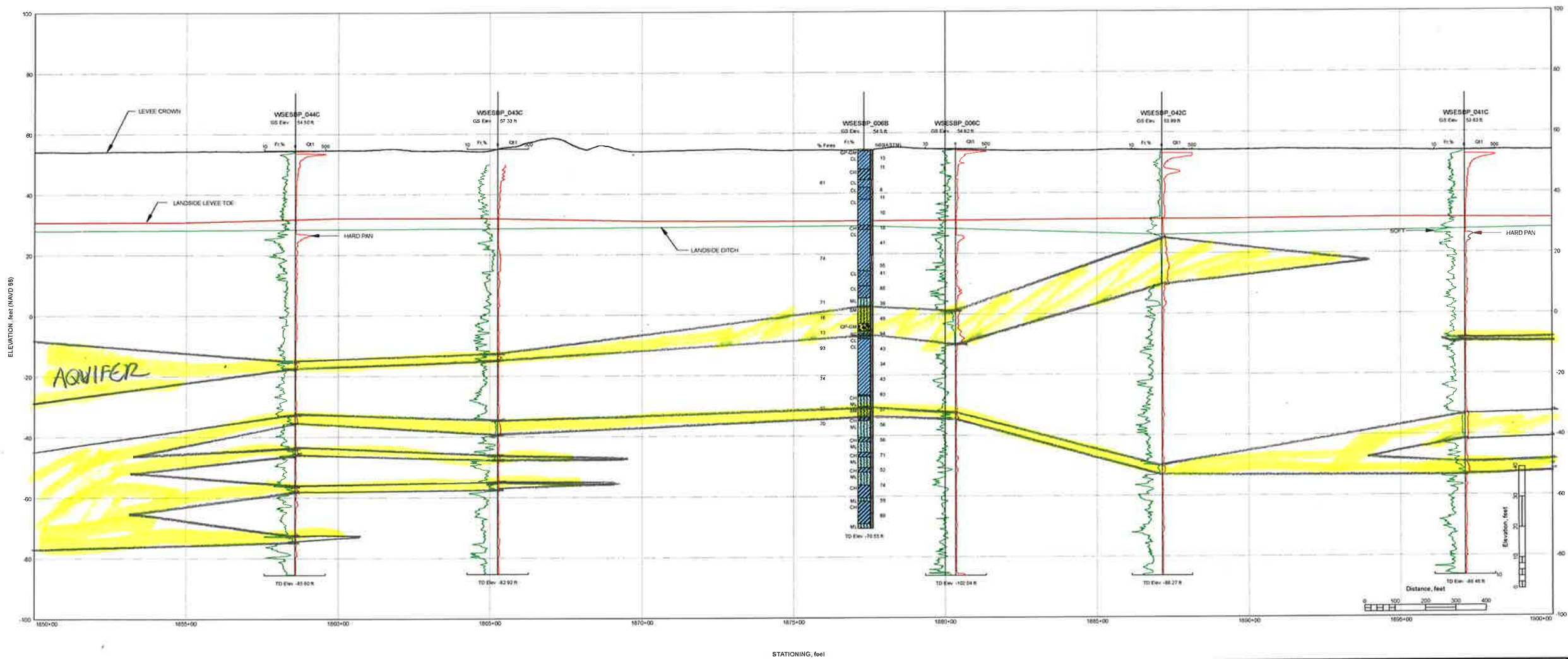

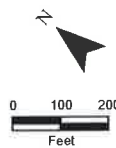

- NOTES:
1. Elevations of levee crown, landside toe, and landside depression/ditch are approximate.
 2. Stratigraphy between explorations may differ from that shown at exploration locations.
 3. Only explorations through the levee crown are shown on the profile.
 4. Historical borings on the profile are denoted by an asterisk (*) after the boring name. Historical boring locations and profiles are based on available information. Some historical explorations are shown on the plan but not in the profile if the log was not available or was close to a new exploration.
 5. USCS classification labels are not presented on the profiles for soil lenses (thickness less than 1.5 ft).
 6. This is a color figure. Black and white reproductions should not be relied upon as data will be lost.
 7. To prevent scale distortion, this map should be printed on a "D" size sheet (22x34 inches).
 8. Surficial geology was mapped at 1:20,000.

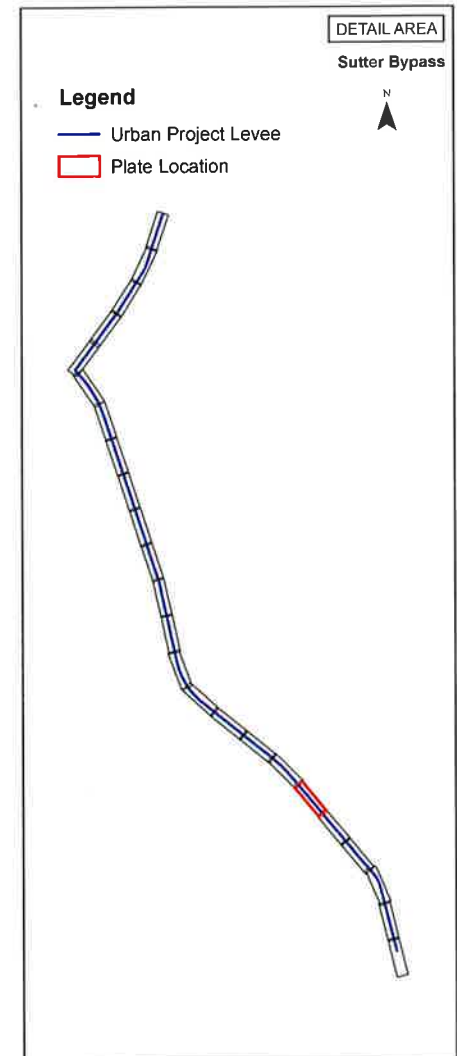
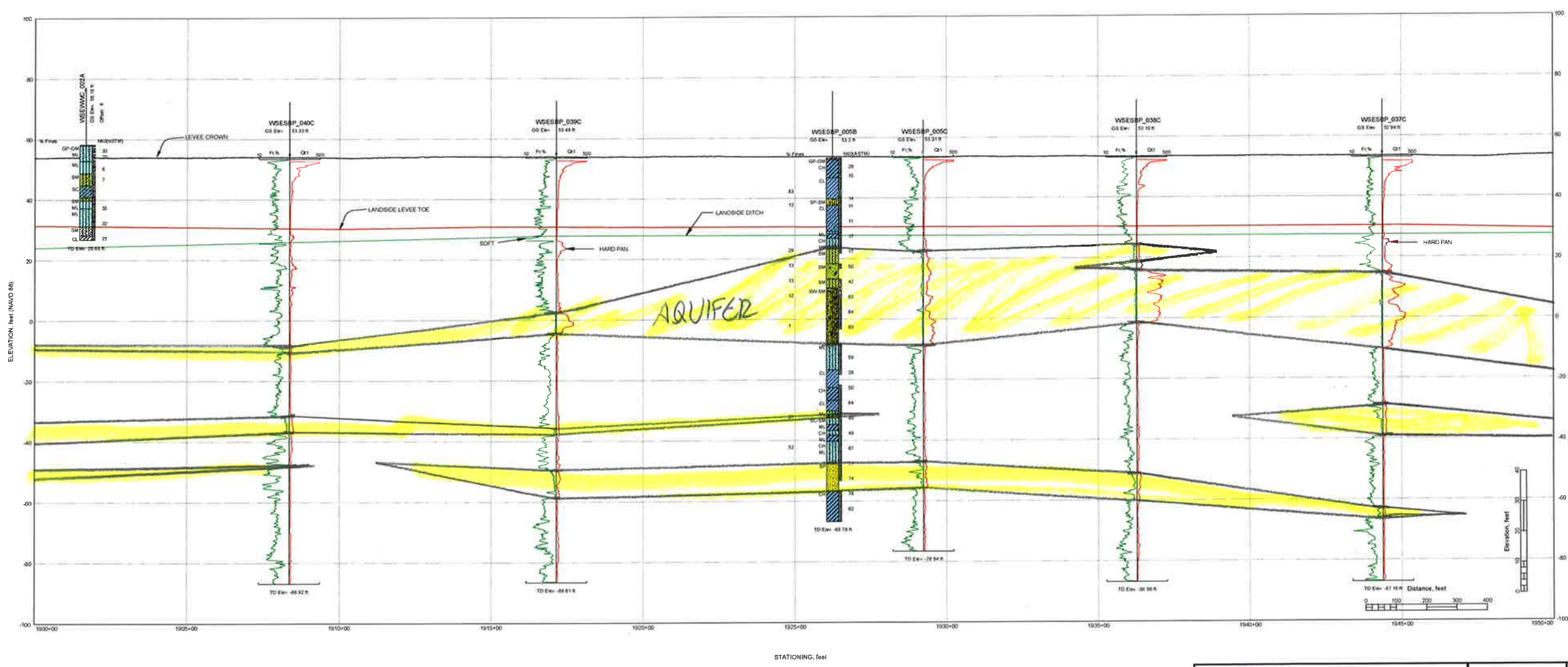

I:\Projects\2014\Wadsworth Canal\GIS\Map_Series\Map_Series_1\Map_Series_1.mxd
 11/11/2014 10:11:11 AM
 User: jgarcia

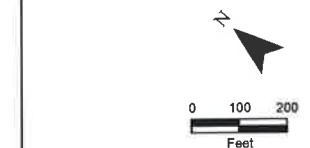
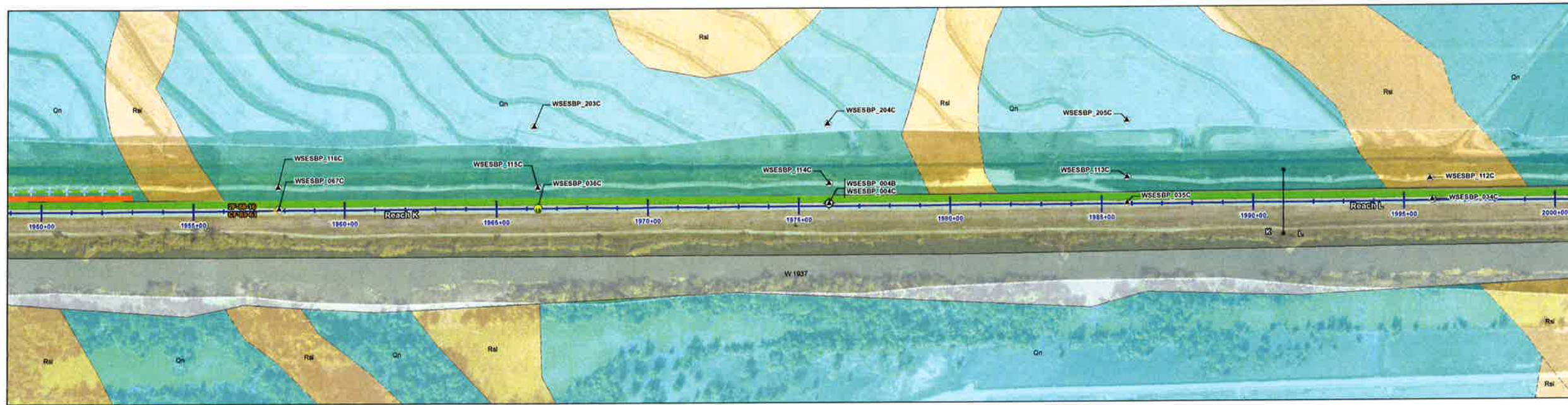

- NOTES:
1. Elevations of levee crown, landslide toe, end landslide depression/ditch are approximate.
 2. Stratigraphy between explorations may differ from that shown of exploration locations.
 3. Only explorations through the levee crown are shown on the profile.
 4. Historical borings on the profile are denoted by an asterisk (*) after the boring name. Historical boring locations and profiles are based on available information. Some historical explorations are shown on the plan but not in the profile if the log was not available or was close to a new exploration.
 5. USCS classification labels are not presented on the profiles for soil lenses (thickness less than 1.5 ft).
 6. This is a color figure. Black and white reproductions should not be relied upon as data will be lost.
 7. To prevent scale distortion, this map should be printed on a "D" size sheet (22x34 inches).
 8. Surficial geology was mapped at 1:20,000.

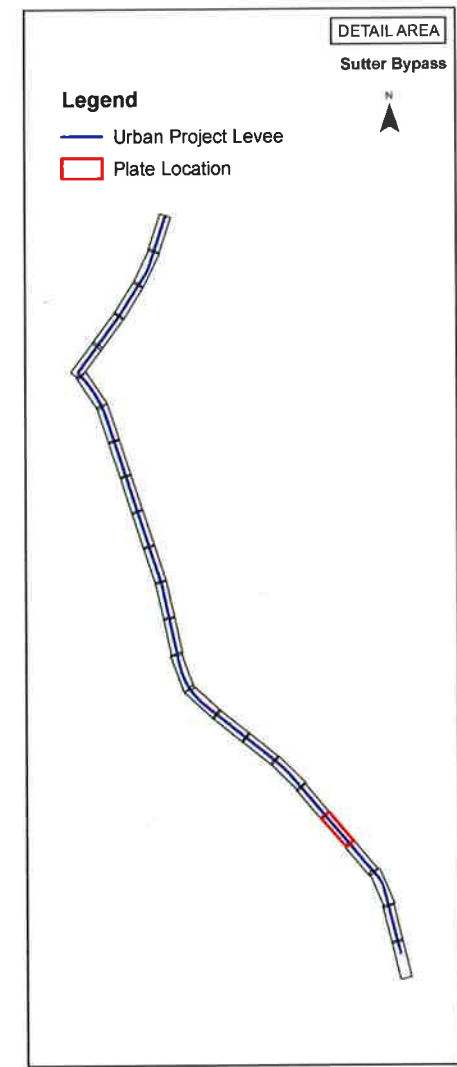
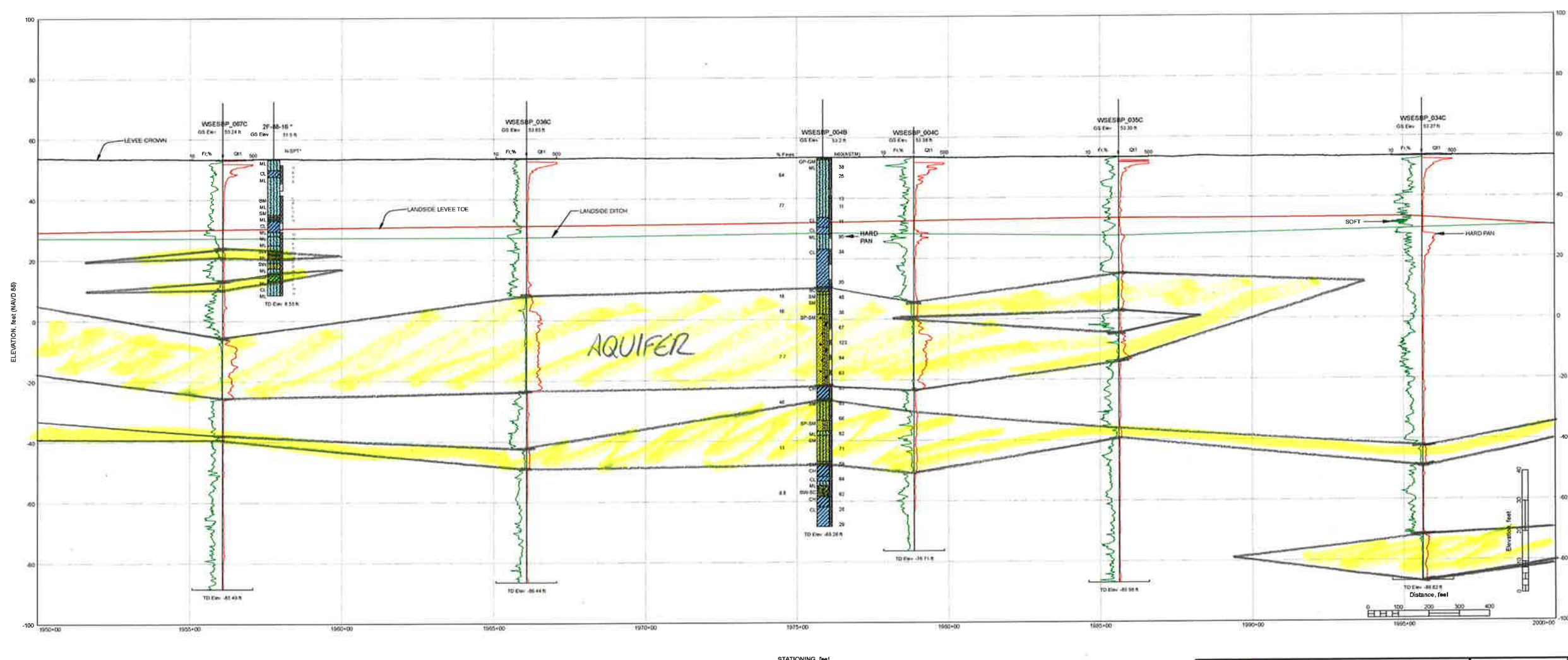

I:\projects\2013\Wadsworth Canal\GIS\Map_Series\Plate_22.mxd

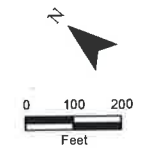
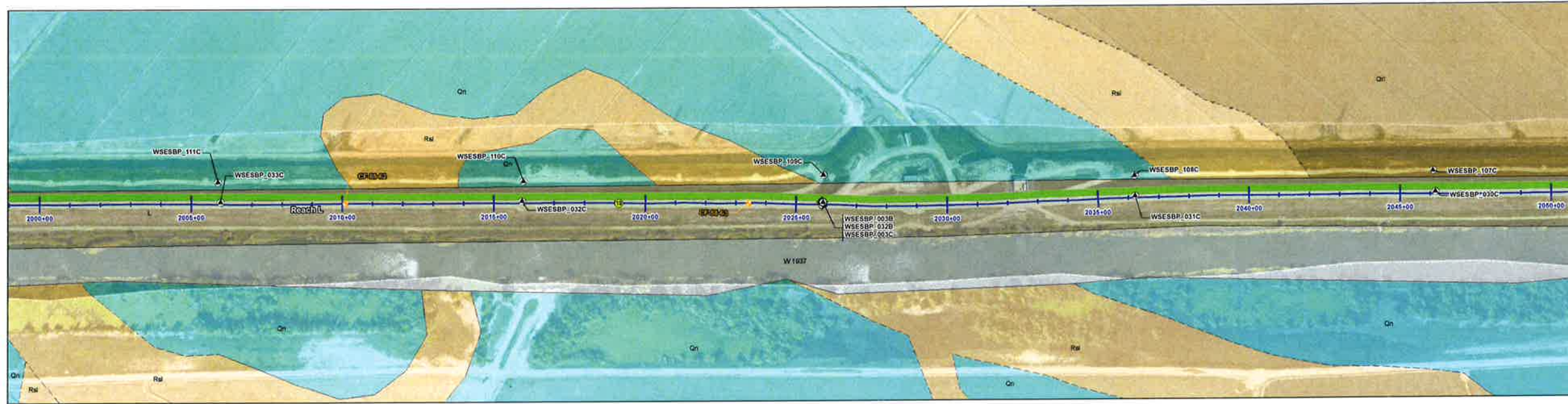

- NOTES:
- Elevations of levee crown, landside toe, and landside depression/ditch are approximate.
 - Stratigraphy between explorations may differ from that shown at exploration locations.
 - Only explorations through the levee crown are shown on the profile.
 - Historical borings on the profile are denoted by an asterisk (*) after the boring name. Historical boring locations and profiles are based on available information. Some historical explorations are shown on the plan but not in the profile if the log was not available or was close to a new exploration.
 - USCS classification labels are not presented on the profiles for soil lenses (thickness less than 1.5 ft).
 - This is a color figure. Black and white reproductions should not be relied upon as data will be lost.
 - To prevent scale distortion, this map should be printed on a "D" size sheet (22x34 inches).
 - Surficial geology was mapped at 1:20,000.

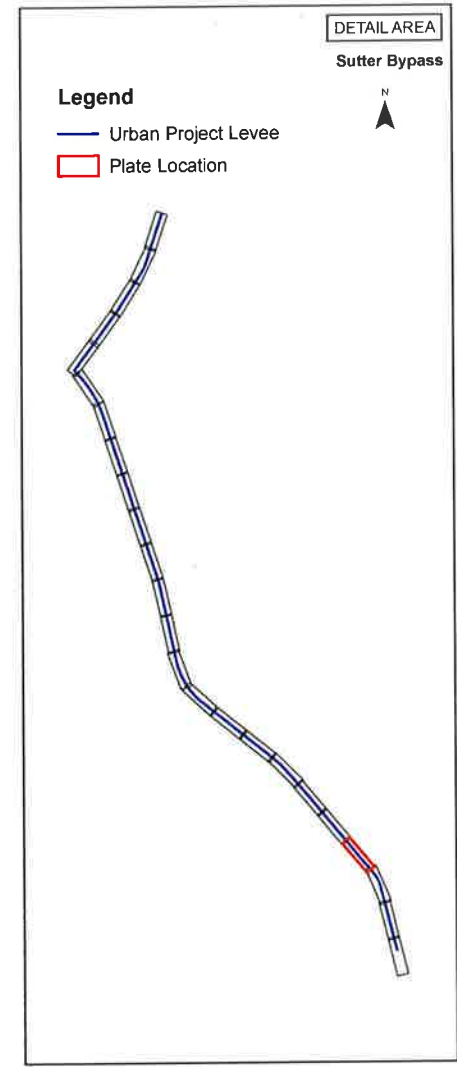
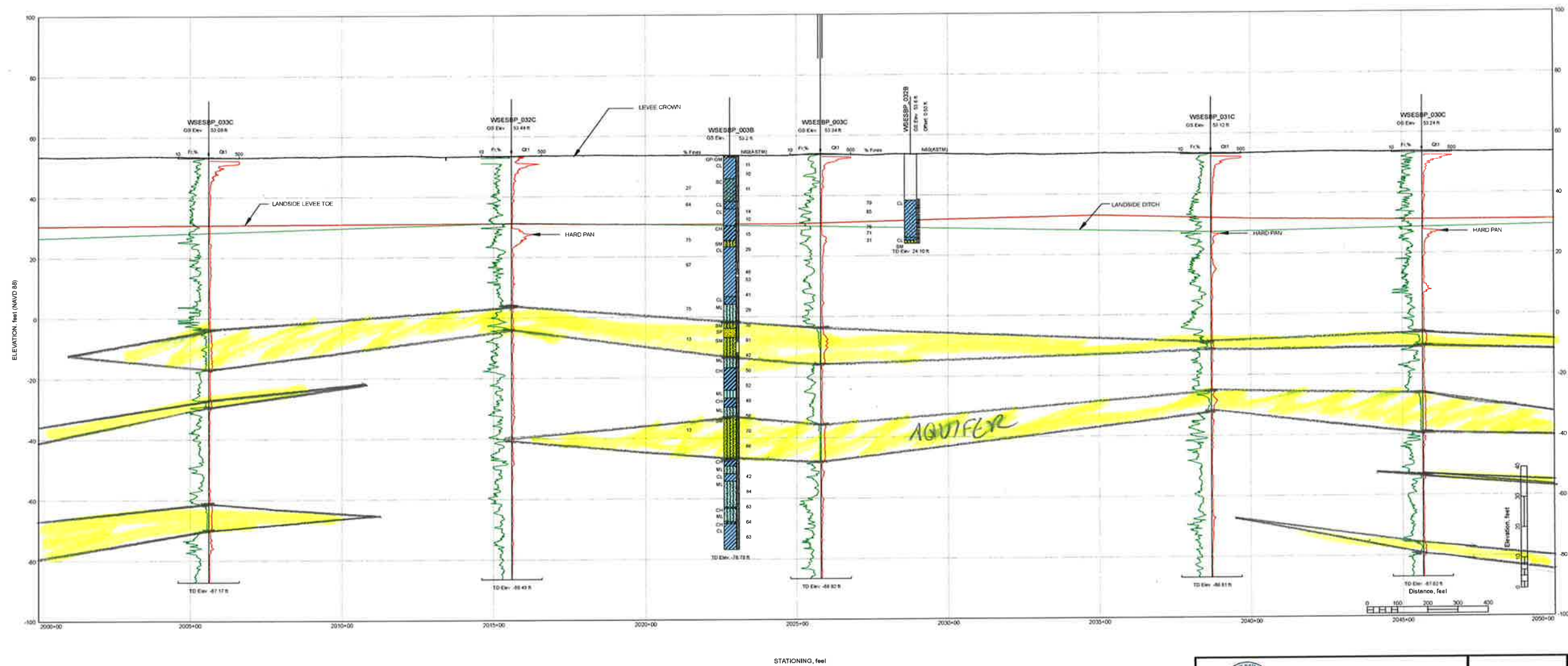

L:\projects\2008\20080127\20080127\RESULTS_GIS\1111000_BUTS_GIS\1111000\20080127\20080127.dwg

Geotechnical Evaluation Report

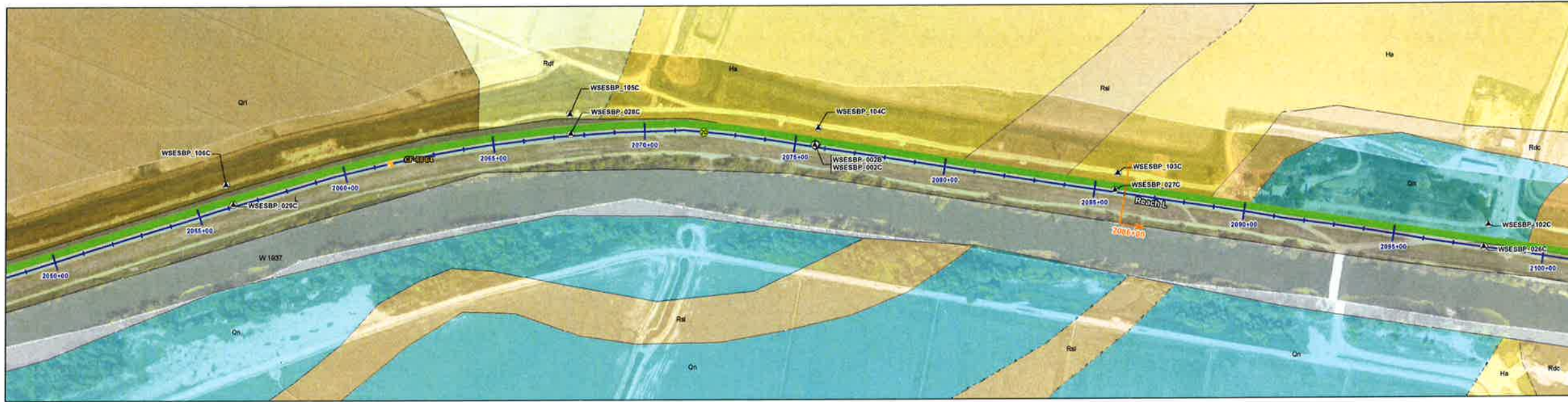

- NOTES:
1. Elevations of levee crown, landside toe, and landside depression/ditch are approximate.
 2. Stratigraphy between explorations may differ from that shown at exploration locations.
 3. Only explorations through the levee crown are shown on the profile.
 4. Historical borings on the profile are denoted by an asterisk (*) after the boring name. Historical boring locations and profiles are based on available information. Some historical explorations are shown on the plan but not in the profile if the log was not available or was close to a new exploration.
 5. USCS classification labels are not presented on the profiles for soil lenses (thickness less than 1.5 ft).
 6. This is a color figure. Black and white reproductions should not be relied upon as data will be lost.
 7. To prevent scale distortion, this map should be printed on a "D" size sheet (22x34 inches).
 8. Surficial geology was mapped at 1:20,000.

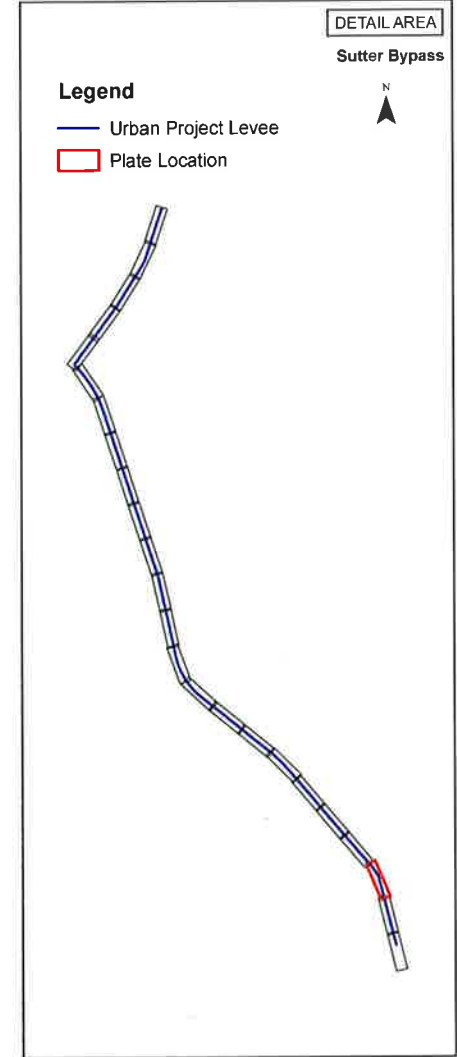
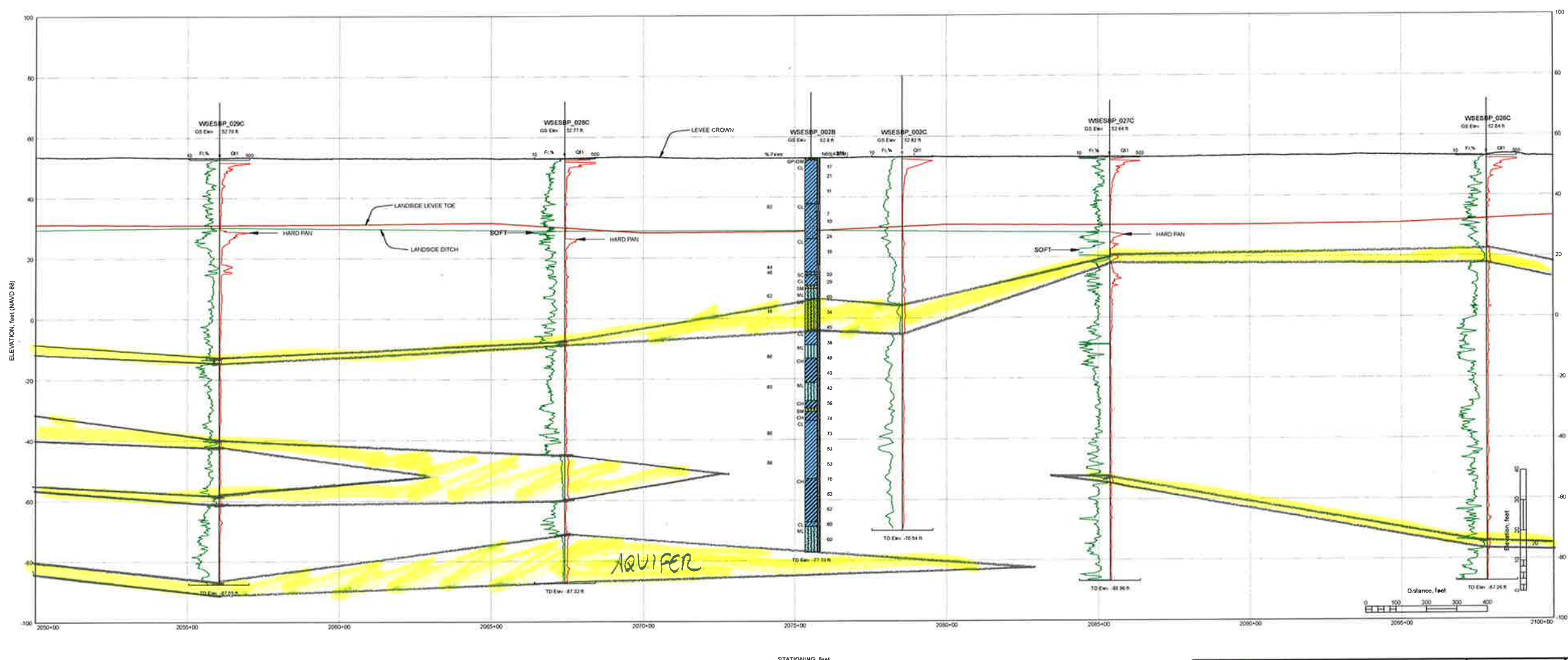

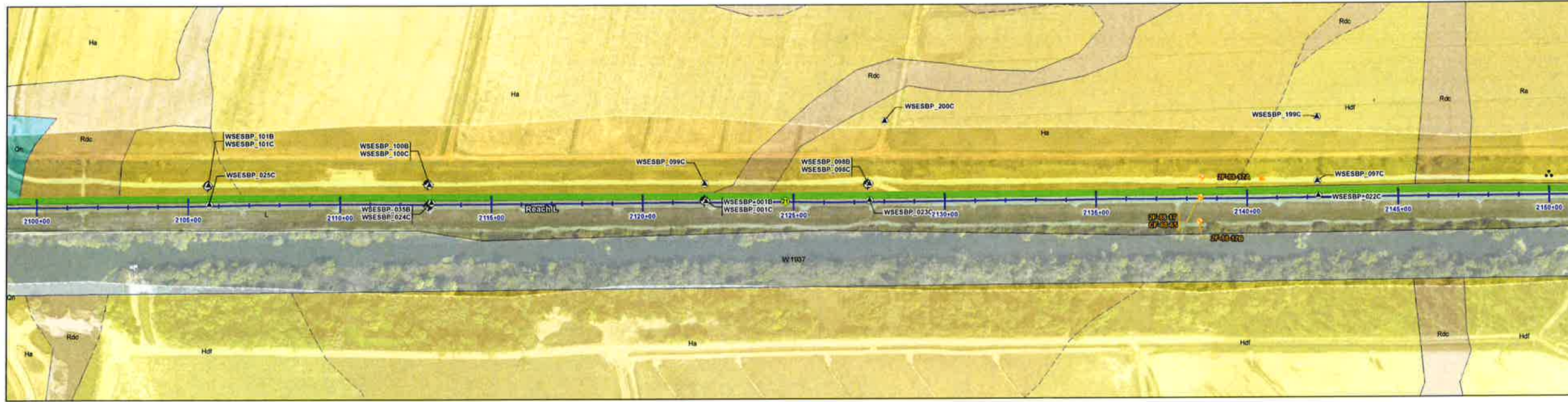

- NOTES:
- Elevations of levee crown, landside toe, and landside depression/ditch are approximate.
 - Stratigraphy between explorations may differ from that shown at exploration locations.
 - Only explorations through the levee crown are shown on the profile.
 - Historical borings on the profile are denoted by an asterisk (*) after the boring name. Historical boring locations and profiles are based on available information. Some historical explorations are shown on the plan but not in the profile if the log was not available or was close to a new exploration.
 - USCS classification labels are not presented on the profiles for soil lenses (thickness less than 1.5 ft).
 - This is a color figure. Black and white reproductions should not be relied upon as data will be lost.
 - To prevent scale distortion, this map should be printed on a "D" size sheet (22x34 inches).
 - Surficial geology was mapped at 1:20,000.

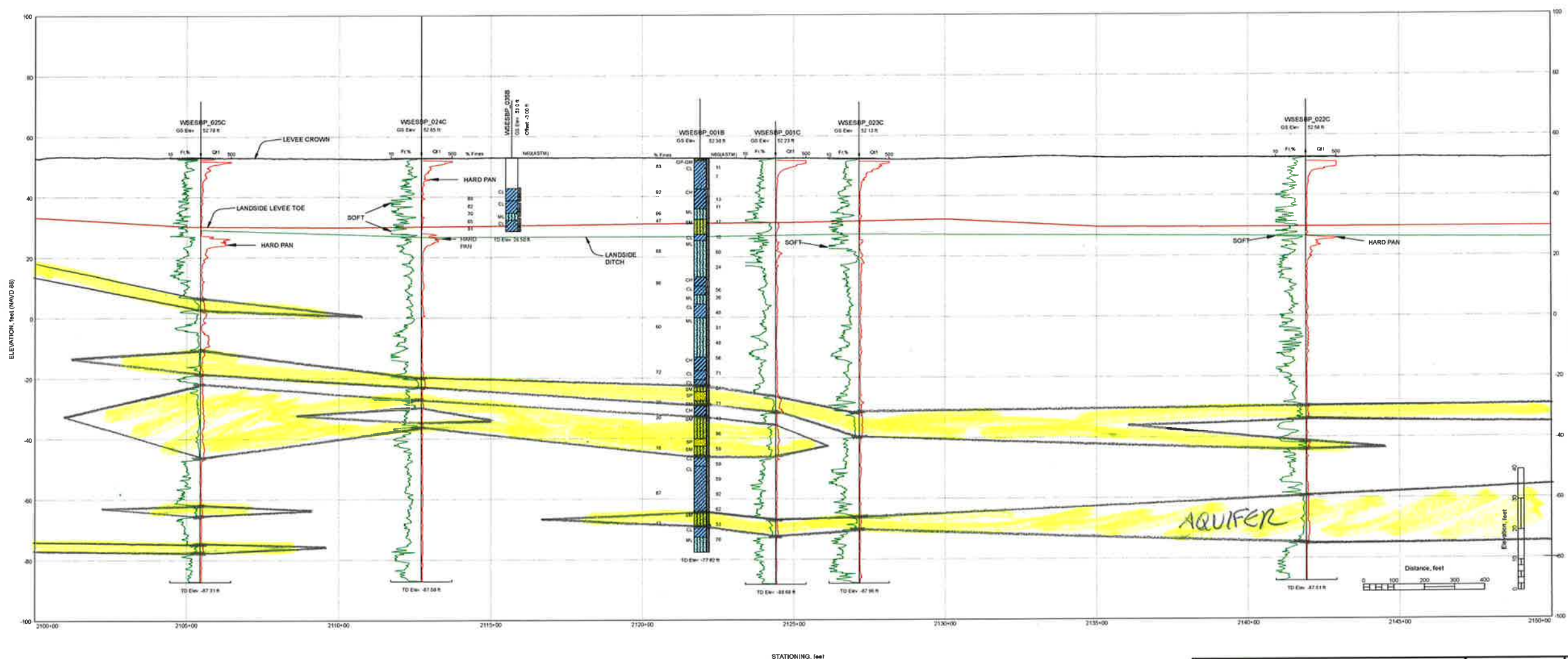

DETAIL AREA

Sutter Bypass

- Legend
- Urban Project Levee
 - Plate Location

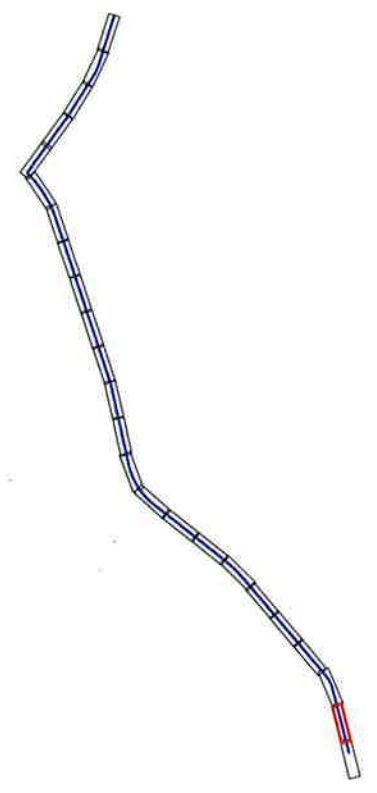

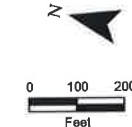

- NOTES:
1. Elevations of levee crown, landside toe, and landside depression/ditch are approximate.
 2. Stratigraphy between explorations may differ from that shown at exploration locations.
 3. Only explorations through the levee crown are shown on the profile.
 4. Historical borings on the profile are denoted by an asterisk (*) after the boring name. Historical boring locations and profiles are based on available information. Some historical explorations are shown on the plan but not in the profile if the log was not available or was close to a new exploration.
 5. USCS classification labels are not presented on the profiles for soil lenses (thickness less than 1.5 ft).
 6. This is a color figure. Black and white reproductions should not be relied upon as data will be lost.
 7. To prevent scale distortion, this map should be printed on a "D" size sheet (22x34 inches).
 8. Surficial geology was mapped at 1:20,000.

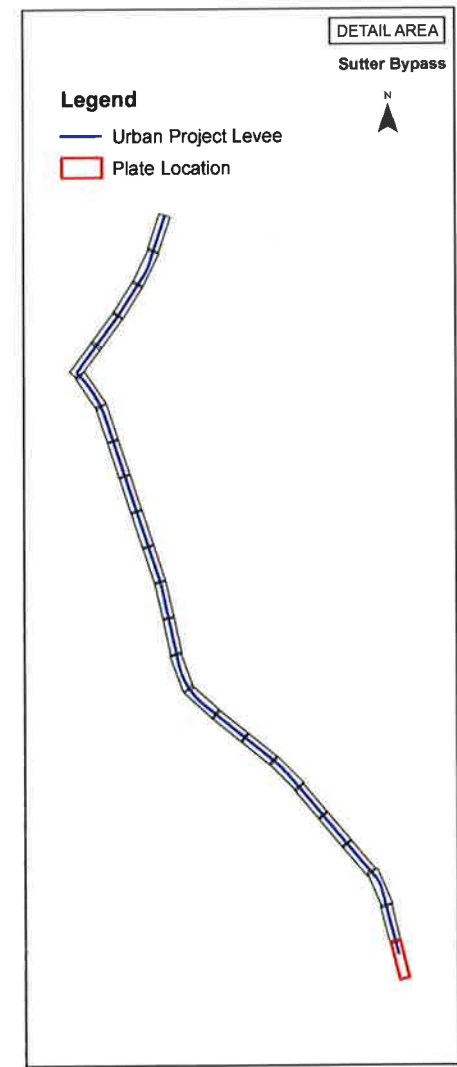
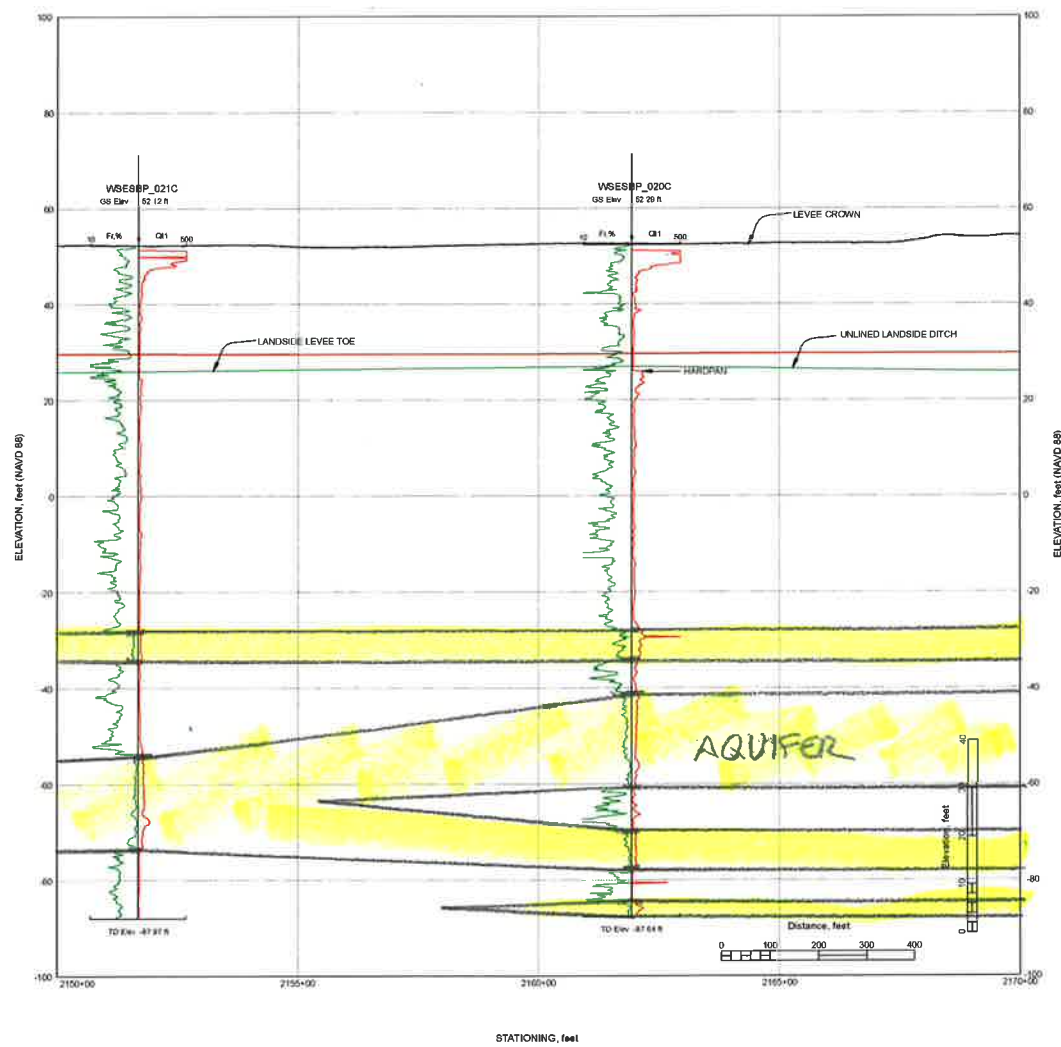

This page intentionally left blank.

Appendix 5-E
Complete Hydrographs for Nested Wells

This page intentionally left blank.

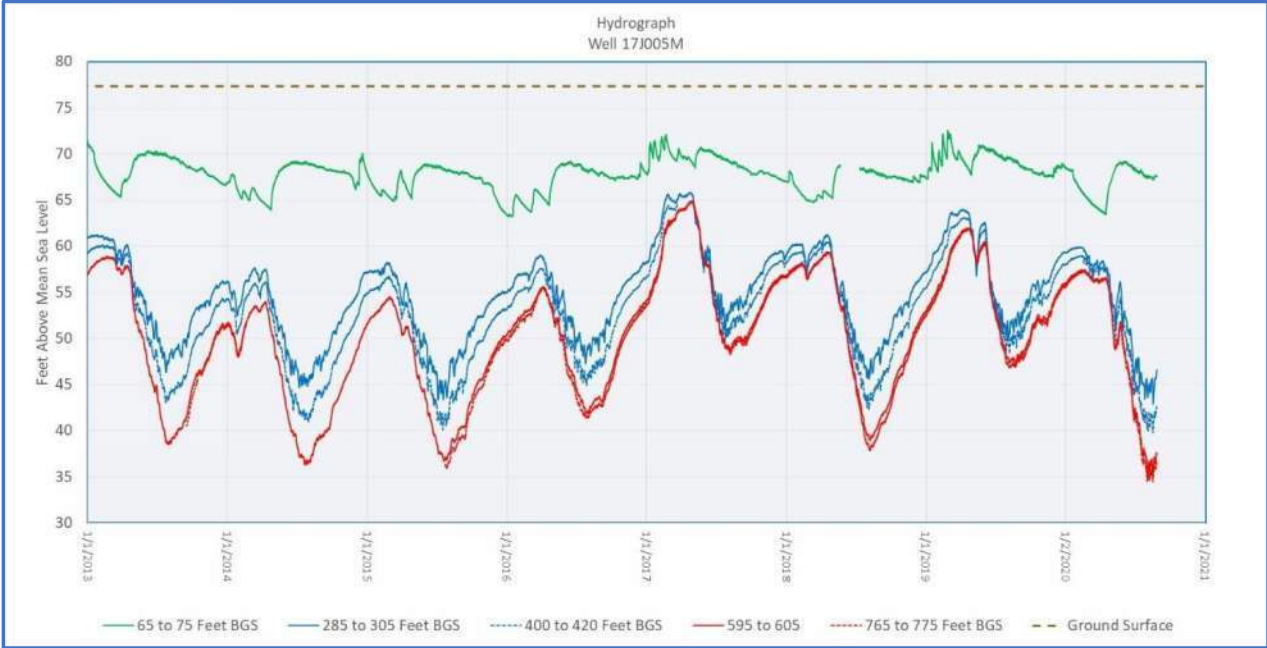
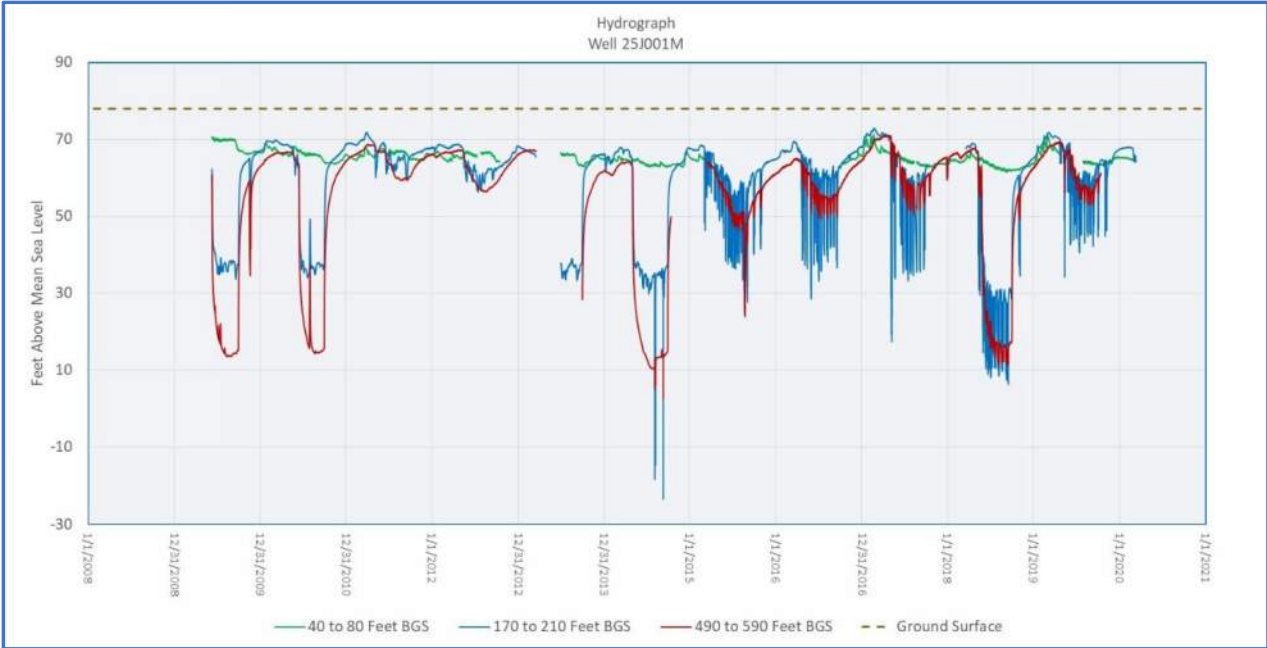

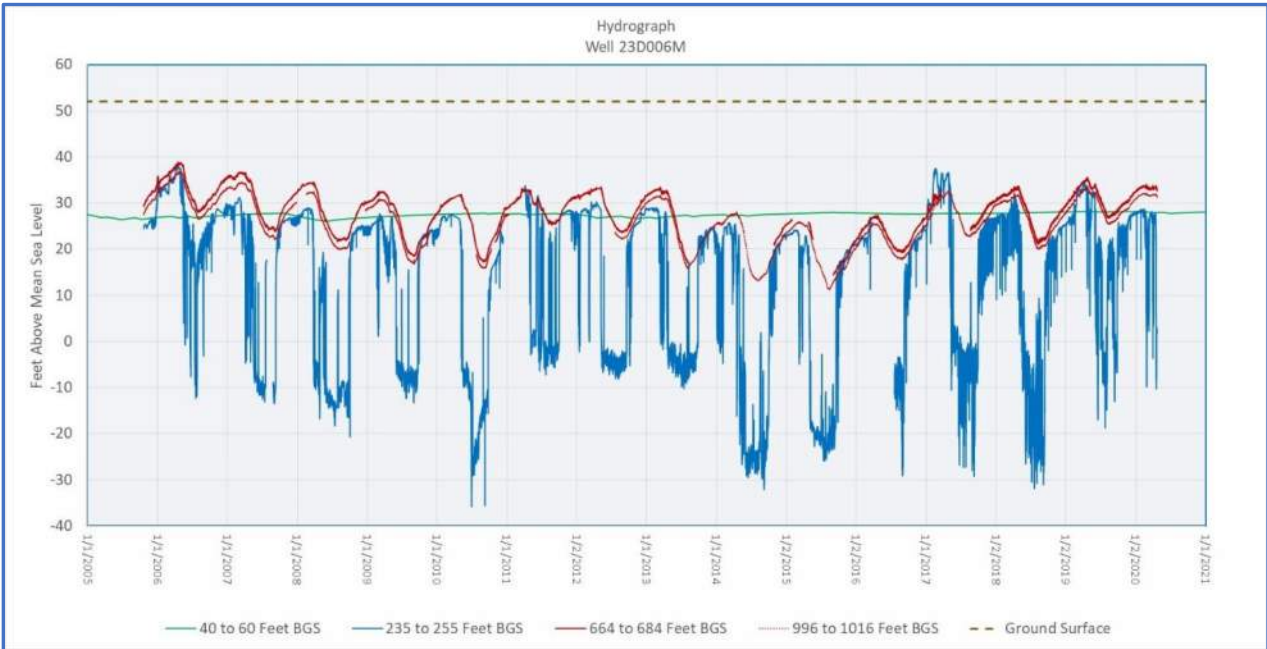
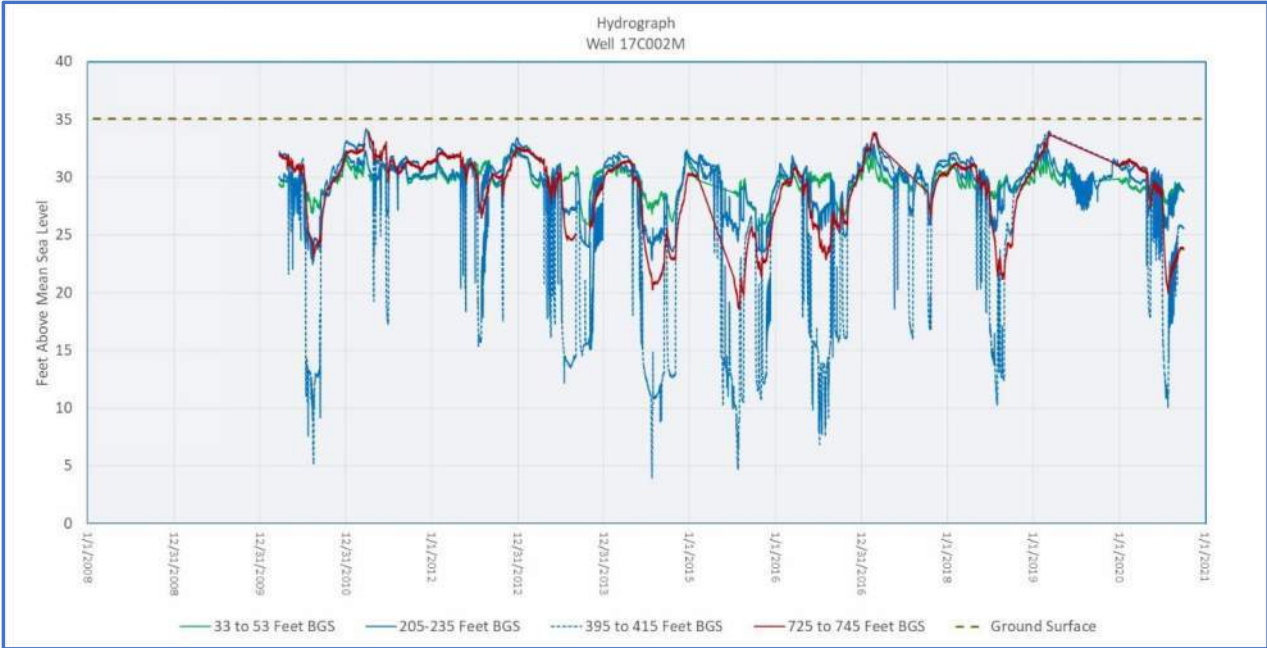



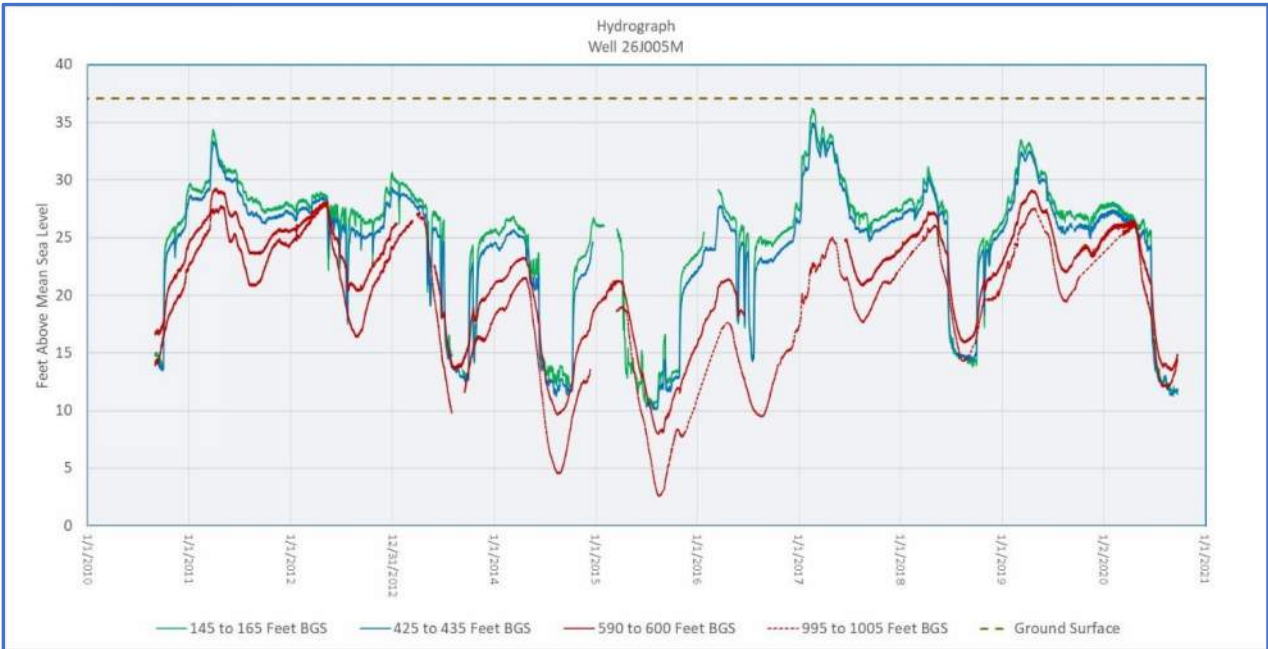
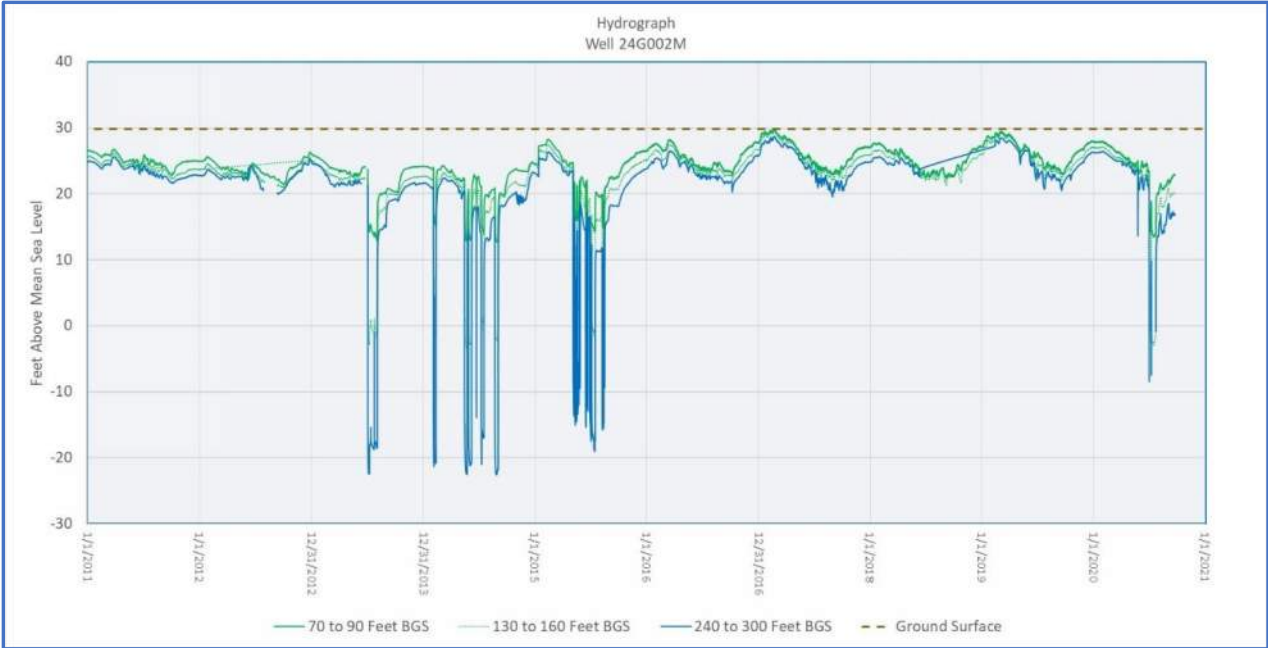

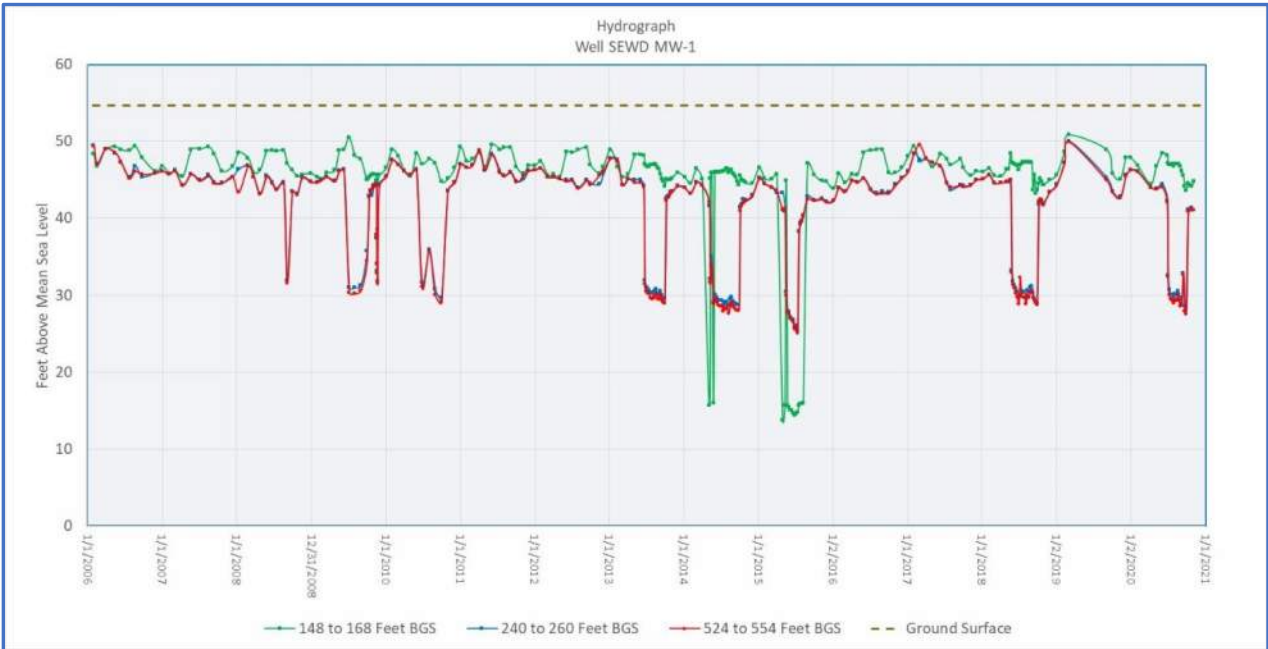
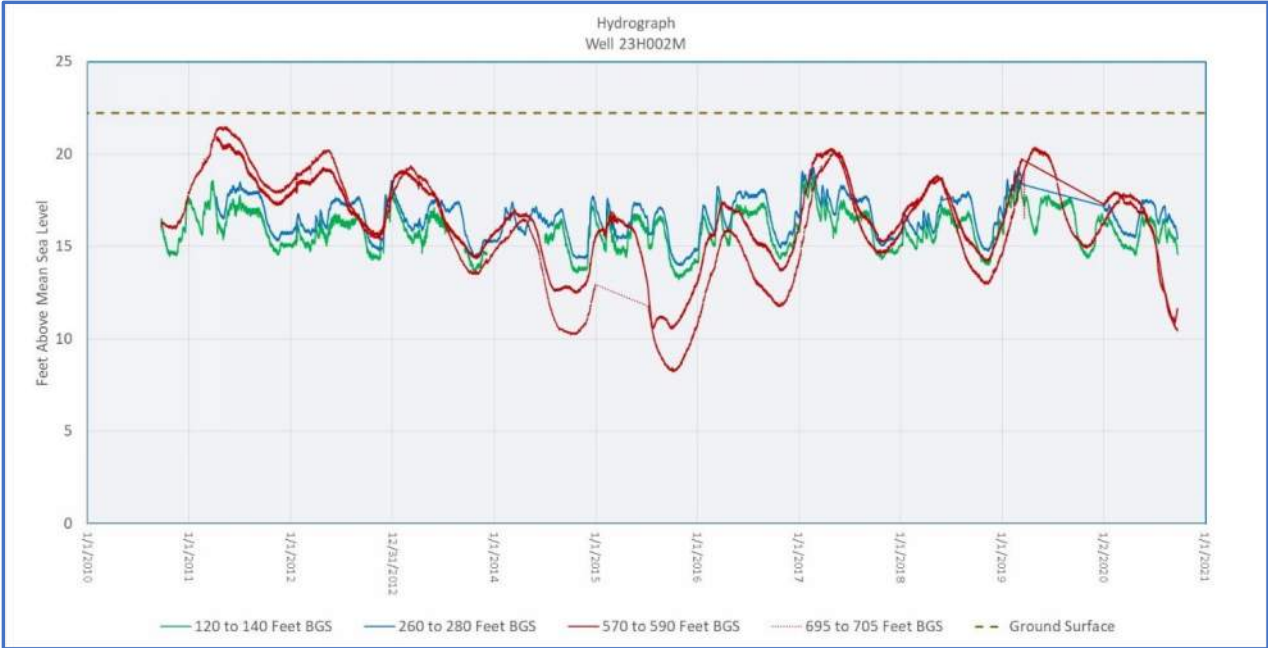

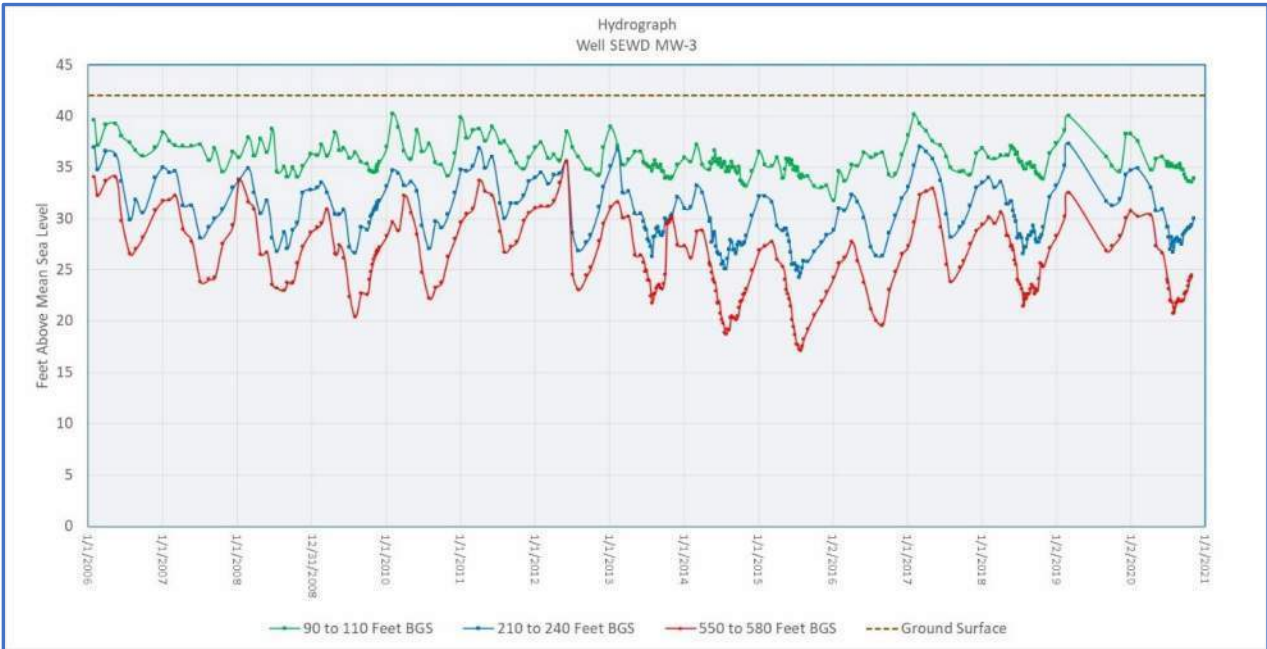
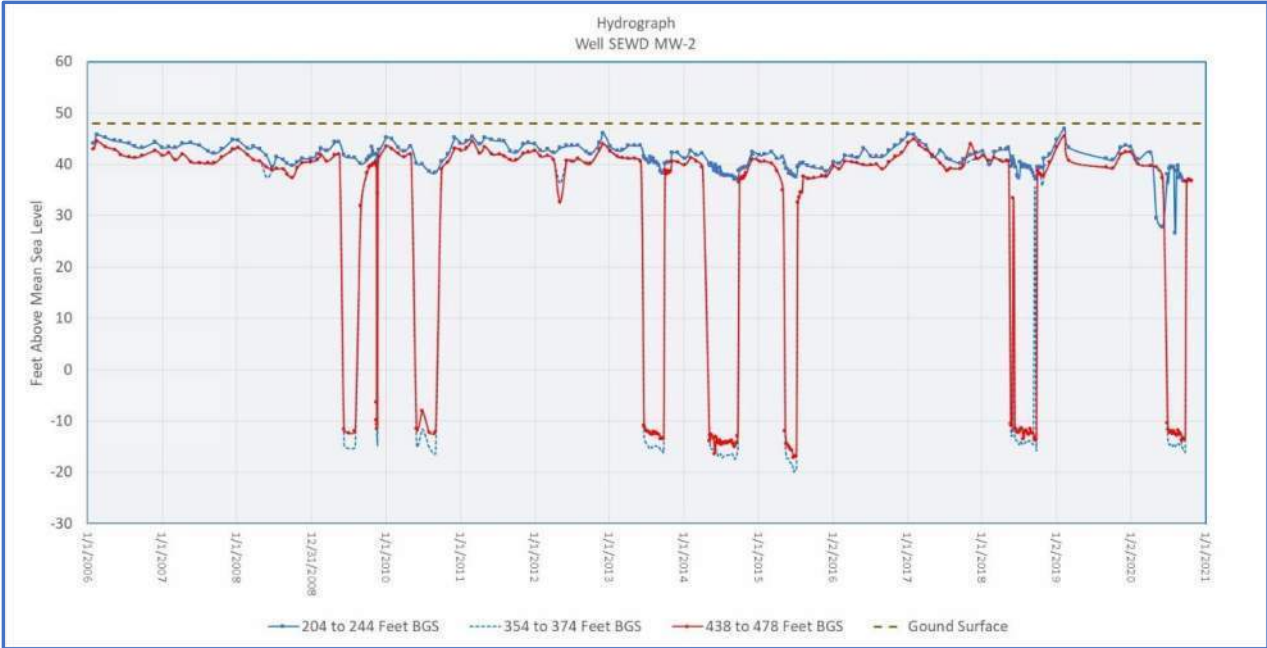

Appendix 5-F
Wells from DWR Database, Specific Capacities, and
Estimated T and K Values

This page intentionally left blank.

Specific Capacity Calculations
 Estimates of Transmissivity and Hydraulic Conductivity
 Sutter Subbasin GSP

Data From DWR Webpage: <https://dwr.maps.arcgis.com/apps/webappviewer/index.html?id=181078580a214c0986e2da28f8623b37>

Wells Completed in Aquifer Zone 1

Well Number	Well Location	Latitude	Longitude	Total Depth	Static Water Level	Total Drawdown	Pump Test Length	Pumping Rate	Specific Capacity	T (x200.52)	T (x 267.36)	Aquifer Zone	Thickness	K		
				Feet BGS	Feet BGS	Feet BGS	Hour	GPM	GPM/Ft	Ft2/Day	Ft2/Day		Ft	ft/day	x 1500	x 2000
WCR1995-005183	O'BANION RD	39.03262	-121.6626	60	6	35	8	600	17.14	3,437.49	4,583.31	1	150	23	31	
WCR2002-000570	3680 MAWSON RD	39.18167879	-121.9187762	60	11	50	1	200	4.00	802.08	1,069.44	1	150	5	7	
WCR2020-000998	2543 N Meridian RD	39.1620611	-121.9314566	65	8	20	40	700	35.00	7,018.20	9,357.60	1	150	47	62	
WCR2005-003899	3400 S BUTTE RD	39.14823668	-121.7099171	75	10	10	12	100	10.00	2,005.20	2,673.60	1	150	13	18	
WCR2019-011164	2833 Carmelita	39.1516936	-121.6679402	76	10.6	4	2	10	2.50	501.30	668.40	1	150	3	4	
WCR2010-000459	4912 BROADWAY	39.20234124	-121.6793316	80	10	80	2	50	0.63	125.33	167.10	1	150	1	1	
WCR2008-001304	6583 KENT AVE	39.22592	-121.64191	80	12	50	1	60	1.20	240.62	320.83	1	150	2	2	
WCR1995-005189	2272 SCHEIBER RD	38.91665737	-121.5666446	82	15	35	24	300	8.57	1,718.74	2,291.66	1	150	11	15	
WCR2012-000214	13184 S BUTTE RD	39.1461111	-121.8577778	88	18	60	2	50	0.83	167.10	222.80	1	150	1	1	
WCR2008-001384	7433 BURCH RD	39.01910958	-121.6492137	90	10	70	1	80	1.14	229.17	305.55	1	150	2	2	
WCR2011-000303	3705 MERIDIAN RD	39.18270902	-121.9393294	90	20	60	1	30	0.50	100.26	133.68	1	150	1	1	
WCR2004-004796	LOT 28 MAYOR RD	38.97442	-121.62558	95	58	8	12	25	3.13	626.63	835.50	1	150	4	6	
WCR2006-002741	2409 SCHEIBER RD	38.91888484	-121.5725354	95	10	16	5	45	2.81	563.96	751.95	1	150	4	5	
WCR2006-002865	2409 SCHEIBER RD	38.91674	-121.57021	95	10	16	5	45	2.81	563.96	751.95	1	150	4	5	
WCR2008-001311	BURCH RD	39.01182913	-121.6463455	99	19	60	8	1300	21.67	4,344.60	5,792.80	1	150	29	39	
WCR2006-002752	322 LEE RD	38.88147323	-121.6010323	100	8	21	4	35	1.67	334.20	445.60	1	150	2	3	
WCR2020-013577	None	39.110023	-121.72534	100	12	20	4	100	5.00	1,002.60	1,336.80	1	150	7	9	
WCR2019-012771	1779 Starr ST	39.0925217	-121.6478039	100	None	11	2	40	3.64	729.16	972.22	1	150	5	6	
WCR2019-011175	2611 Lincoln RD	39.1126113	-121.6642354	100	None	11	2	40	3.64	729.16	972.22	1	150	5	6	
WCR2008-001389	5272 FRANKLIN RD	39.12632497	-121.7142173	100	5	70	1	100	1.43	286.46	381.94	1	150	2	3	
WCR2019-011166	2717 Paseo RD	39.2528122	-121.6646209	100	12	7	1	10	1.43	286.46	381.94	1	150	2	3	
WCR2012-000308	3052 THOMPSON RD	38.99231418	-121.6768252	105	11	50	32.5	1500	30.00	6,015.60	8,020.80	1	150	40	53	
WCR2014-000103	174 LEE RD	38.8825313	-121.6062354	105	25	35	20	35	1.00	200.52	267.36	1	150	1	2	
WCR2006-002746	188 LEE RD	38.88242739	-121.6057253	105	12	21	4	26	1.24	248.26	331.02	1	150	2	2	
WCR2006-002747	220 LEE RD	38.88221964	-121.6047051	105	12	21	4	26	1.24	248.26	331.02	1	150	2	2	
WCR1990-007505	KARNACK RD	38.79913	-121.68223	105	None	40	1	40	1.00	200.52	267.36	1	150	1	2	
WCR2018-009923	None	39.2511562	-121.7289779	110	12	105	28	1000	9.52	1,909.71	2,546.29	1	150	13	17	
WCR2020-013147	None	38.981461	-121.653353	110	17	40	8	1200	30.00	6,015.60	8,020.80	1	150	40	53	
WCR2020-012008	5637 Seaton RD	39.2718	-121.71809	112	7	5	4	100	20.00	4,010.40	5,347.20	1	150	27	36	
WCR2008-001383	8851 GARDEN HWY	38.99968136	-121.6110539	115	18	60	1	50	0.83	167.10	222.80	1	150	1	1	
WCR2007-000582	None	38.87136953	-121.7022933	116	5	50	2	70	1.40	280.73	374.30	1	150	2	2	
WCR2011-000307	2941 RAILROAD AVE	39.08394536	-121.626216	118	30	60	4	100	1.67	334.20	445.60	1	150	2	3	
WCR2007-001067	None	38.86891486	-121.6103406	120	8	20	4	45	2.25	451.17	601.56	1	150	3	4	
WCR2010-000959	674 MORGAN ESTATES DR	39.07862192	-121.6186741	120	22	80	2	100	1.25	250.65	334.20	1	150	2	2	
WCR2008-001352	2082 PENNINGTON RD	39.27488926	-121.6528317	120	8	100	2	100	1.00	200.52	267.36	1	150	1	2	
WCR2008-001353	2351 PENNINGTON RD	39.2777034	-121.6573265	120	9	100	2	150	1.50	300.78	401.04	1	150	2	3	
WCR2018-000407	373 Shannon RD	39.0072827	-121.6105897	125	16	17.32	3	117	6.76	1,354.55	1,806.07	1	150	9	12	
WCR2010-000460	2198 FARMLAN RD	39.16288826	-121.9005293	130	12	53	30	2200	41.51	8,323.47	11,097.96	1	150	55	74	
WCR2004-005630	1198 3RD ST	39.14530641	-121.9150865	130	20	100	8	100	1.00	200.52	267.36	1	150	1	2	
WCR2007-001432	20832 CRANMORE RD	38.82443809	-121.7202187	130	20	80	4	500	6.25	1,253.25	1,671.00	1	150	8	11	
WCR2011-000299	980 OSWALD RD	39.06869717	-121.6268903	130	None	100	2	45	0.45	90.23	120.31	1	150	1	1	
WCR2013-000103	None	39.02994203	-121.6701727	130	15	70	2	200	2.86	572.91	763.89	1	150	4	5	
WCR1992-008199	None	39.18513397	-121.896449	135	20	21	48	600	28.57	5,729.14	7,638.86	1	150	38	51	
WCR2009-001111	833 TUDOR RD	39.00787811	-121.6208584	135	17	105	24	1800	17.14	3,437.49	4,583.31	1	150	23	31	
WCR2020-008504	0 VARNEY RD	38.8892064	-121.6368468	135	16	10	8	250	25.00	5,013.00	6,684.00	1	150	33	45	
WCR1999-001083	933 BARRY RD #A	39.07687141	-121.6262527	135	18	60	8	1000	16.67	3,342.00	4,456.00	1	150	22	30	
WCR2020-009702	0 VARNEY RD	38.889208	-121.636847	137	11	80	8	1200	15.00	3,007.80	4,010.40	1	150	20	27	
WCR2006-001088	None	39.18093503	-121.6920306	140	8	45	16	1000	22.22	4,456.00	5,941.33	1	150	30	40	
WCR2020-009284	0 VARNEY RD	38.8868226	-121.6445662	140	8	102	8	1000	9.80	1,965.88	2,621.18	1	150	13	17	
WCR2012-003642	None	39.05696199	-121.7567986	140	5	40	8	2500	62.50	12,532.50	16,710.00	1	150	84	111	
WCR2011-000308	4545 NUESTRO RD	39.18654404	-121.6986425	140	6	60	4	80	1.33	267.36	356.48	1	150	2	2	
WCR2006-002438	40 W ONSTOTT FRONTAGE F	39.19338659	-121.6361534	140	20	60	2	60	1.00	200.52	267.36	1	150	1	2	
WCR2004-004377	1703 S MERIDIAN RD	39.10414572	-121.8994558	140	20	30	1	40	1.33	267.36	356.48	1	150	2	2	
WCR2007-001199	None	39.29429054	-121.8056304	140	55	120	1	200	1.67	334.20	445.60	1	150	2	3	
WCR2008-001356	956 MERIDIAN RD	39.14291617	-121.9175521	145	19	135	1	70	0.52	103.97	138.63	1	150	1	1	
WCR1991-005613	None	38.99560533	-121.5915619	145	None	25	0.5	20	0.80	160.42	213.89	1	150	1	1	
WCR2007-001785	None	39.14440193	-121.9000493	148	6	67	42.5	5000	74.63	14,964.18	19,952.24	1	150	100	133	
WCR2007-000573	2303 VALENCIA ST	39.15416302	-121.6581839	150	20	60	1	100	1.67	334.20	445.60	1	150	2	3	
										Average	10	2,634	-	-	13	18
										Median	3	533	-	-	4	5
										Maximum	75	14,964	19,952	-	100	133
										Minimum	0.45	90.23	120.31	-	0.60	0.80

Wells Completed in Aquifer Zone 2

Well Number	Well Location	Latitude	Longitude	Total Depth	Static Water Level	Total Drawdown	Pump Test Length	Pumping Rate	Specific Capacity	T (x200.52)	T (x 267.36)	Aquifer Zone	Thickness	K	
				Feet BGS	Feet BGS	Feet BGS	Hour	GPM	GPM/Ft	Ft/Day	Ft/Day		Ft	ft/day	x 1500
WCR1997-000769	21729 KNIGHTS RD	38.80864188	-121.7140711	153	6	8	2	40	5.00	1,002.60	1,336.80	1 to 2	150	7	9
WCR2007-000578	BISHOP AVE	39.25822558	-121.6506121	155	12	52	38	1200	23.08	4,627.38	6,169.85	1 to 2	150	31	41
WCR2012-000217	None	39.08219609	-121.6226287	155	40	80	4	90	1.13	225.59	300.78	1 to 2	150	2	2
WCR2011-000820	GARMIRE RD & GIRDNER RD	39.07759	-121.82803	157	6	50	56	4000	80.00	16,041.60	21,388.80	1 to 2	150	107	143
WCR2006-002179	3229 CAMINITO AVE	39.08109721	-121.6226272	160	15	80	4	80	1.00	200.52	267.36	1 to 2	150	1	2
WCR2005-004042	15710 CENTRAL ST	39.141215	-121.9063643	160	30	80	4	100	1.25	250.65	334.20	1 to 2	150	2	2
WCR2013-000096	1201 CIVIC CENTER BLVD	39.14543292	-121.6380236	160	17	80	4	300	3.75	751.95	1,002.60	1 to 2	150	5	7
WCR2008-001113	None	39.02992886	-121.6666952	160	18	80	2	200	2.50	501.30	668.40	1 to 2	150	3	4
WCR2009-001082	4443 BROADWAY	39.19510881	-121.6779474	160	15	45	1	70	1.56	311.92	415.89	1 to 2	150	2	3
WCR2009-001107	CLARK RD	39.22592	-121.64191	170	22	67	28	1300	19.40	3,890.69	5,187.58	1 to 2	150	26	35
WCR1991-000844	1691 CORSICA DR	39.15723416	-121.641697	170	None	31	0.5	30	0.97	194.05	258.74	1 to 2	150	1	2
WCR2014-000436	10925 KREHE RD	39.2894444	-121.7261111	175	8	40	8	1000	25.00	5,013.00	6,684.00	1 to 2	150	33	45
WCR2019-005702	1708 E Paseo AVE	39.2506128	-121.6438122	180	6	20	8	300	15.00	3,007.80	4,010.40	2	220	14	18
WCR2004-004233	CENTRAL ST.	39.1512	-121.90293	180	17	60	4	100	1.67	334.20	445.60	2	220	2	2
WCR2008-001305	9119 S BUTTE RD	39.15803059	-121.7823026	180	13	90	2	100	1.11	222.80	297.07	2	220	1	1
WCR2019-007479	2292 Tierra Buena RD	39.1604887	-121.6627441	180	None	3	2	20	6.67	1,336.80	1,782.40	2	220	6	8
WCR2013-000113	None	39.10288078	-121.6483068	180	32	80	2	190	2.38	476.24	634.98	2	220	2	3
WCR2008-001732	8921 S BUTTE RD	39.15821167	-121.7797725	186	33	35	8	30	0.86	171.87	229.17	2	220	1	1
WCR2018-004926	O GARDEN HWY	38.967104	-121.616182	190	14	123	8	6000	48.78	9,781.46	13,041.95	2	220	44	59
WCR2020-007682	O MARCUSE	38.9630156	-121.6161123	190	14.7	70	8	2000	28.57	5,729.14	7,638.86	2	220	26	35
WCR1997-006078	5087 S TOWNSHIP RD	39.05202017	-121.6945067	192	4	85	18	3000	35.29	7,077.18	9,436.24	2	220	32	43
WCR2014-001730	11 CYPRESS AVE	38.94826538	-121.5882352	195	22	69	5	1750	25.36	5,085.65	6,780.87	2	220	23	31
WCR2006-003037	10935 GLEDHILL RD	38.96854014	-121.621549	195	9	20	4	50	2.50	501.30	668.40	2	220	2	3
WCR2008-001307	3022 SANDERS RD	39.1977487	-121.6670223	195	18	77	3.5	1800	23.38	4,687.48	6,249.97	2	220	21	28
WCR2005-003519	STEWART RD	39.09118	-121.60675	198	25	68	16	1800	26.47	5,307.88	7,077.18	2	220	24	32
WCR2013-000107	3841 MAWSON RD	39.18537787	-121.9123859	200	10	41	26	1600	39.02	7,825.17	10,433.56	2	220	36	47
WCR2005-004035	16403 BURRIS RD	39.15456071	-121.9193635	200	15	100	4	150	1.50	300.78	401.04	2	220	1	2
WCR2003-000977	3934 BROADWAY	39.18740237	-121.679834	200	14	30	1	300	10.00	2,005.20	2,673.60	2	220	9	12
WCR2010-001077	None	39.11012862	-121.8311121	205	8	59	32	4000	67.80	13,594.58	18,126.10	2	220	62	82
WCR2014-000437	PASEO RD	39.24815207	-121.6705429	210	6	65	8	1000	15.38	3,084.92	4,113.23	2	220	14	19
WCR2007-001435	21711 KNIGHTS RD	38.80953396	-121.7140424	210	20	65	4	100	1.54	308.49	411.32	2	220	1	2
WCR2008-001299	None	39.28546248	-121.8869516	215	9	105	74	3000	28.57	5,729.14	7,638.86	2	220	26	35
WCR2002-000569	TOF FRONTAG,E, N OF EAGE	39.1968	-121.64192	215	36	70	17	1200	17.14	3,437.49	4,583.31	2	220	16	21
WCR2009-001077	5236 BUTTE HOUSE RD	39.16123882	-121.7096227	222	6	81	24	4000	49.38	9,902.22	13,202.96	2	220	45	60
WCR2008-001385	3678 E BUTTE RD	39.18189905	-121.7211997	225	26	91	52	4500	49.45	9,915.82	13,221.10	2	220	45	60
WCR2009-001113	None	39.14686643	-121.7424419	225	19	60	38	1500	25.00	5,013.00	6,684.00	2	220	23	30
WCR2019-006771	2891 Paseo AVE	39.2504751	-121.6679899	225	7	78	20	900	11.54	2,313.69	3,084.92	2	220	11	14
WCR2019-007439	O paseo AVE	39.2503366	-121.6371429	225	8	28	8	300	10.71	2,148.43	2,864.57	2	220	10	13
WCR2009-001075	2760 ENCINAL RD	39.21648436	-121.6657935	227	13	93	15	700	7.53	1,509.29	2,012.39	2	220	7	9
WCR2013-000098	None	39.17817882	-121.6994276	240	6	56	37	2900	51.79	10,384.07	13,845.43	2	220	47	63
WCR2008-001110	6670 PENNINGTON RD	39.26811267	-121.7357304	240	1	100	2	250	2.50	501.30	668.40	2	220	2	3
WCR2019-007443	9413 S butte RD	39.1796728	-121.7896338	245	23	57	8	30	0.53	105.54	140.72	2	220	0.480	1
WCR2014-000441	None	39.19577205	-121.7031714	251	8	90	20	3200	35.56	7,129.60	9,506.13	2	220	32	43
WCR2007-001193	GIRDNER RD	39.07836	-121.86536	260	10	60	1	150	2.50	501.30	668.40	2	220	2	3
WCR2000-006758	5087 S TOWNSHIP RD	39.05202017	-121.6945067	262	7	65	2	700	10.77	2,159.45	2,879.26	2	220	10	13
WCR2008-001355	None	39.27778204	-121.7003741	275	7	68	24	1500	22.06	4,423.24	5,897.65	2	220	20	27
WCR2006-002186	None	39.0702972	-121.872433	280	15	60	4	2500	41.67	8,355.00	11,140.00	2	220	38	51
WCR2010-000958	2661 ENCINAL RD	39.21878373	-121.6630068	285	13	71	71	2000	28.17	5,648.45	7,531.27	2	220	26	34
WCR2009-001080	5852 BOGUE RD	39.09666271	-121.7219911	285	4	59	45.5	5000	84.75	16,993.22	22,657.63	2	220	77	103
WCR2011-000300	PASS RD	39.17767406	-121.7625015	285	37	135	24	210	1.56	311.92	415.89	2	220	1	2
WCR2009-001105	BOGUE RD	39.10555	-121.71733	290	7	100	24	4500	45.00	9,023.40	12,031.20	2	220	41	55
WCR2011-006626	20528 CRANMORE RD	38.83074388	-121.7231706	297	27	5	2.5	100	20.00	4,010.40	5,347.20	2	220	18	24
WCR2011-001906	23611 RECLAMATION RD	38.78484	-121.66381	298	2	80	4	500	6.25	1,253.25	1,671.00	2	220	6	8
WCR2011-000309	BUTTE HOUSE RD	39.1547222	-121.6744444	300	18	60	28.5	800	13.33	2,673.60	3,564.80	2	220	12	16
WCR2013-006633	None	38.94578907	-121.7875966	305	9	74	1	5000	67.57	13,548.65	18,064.86	2	220	62	82
WCR2008-001306	5272 CLARK RD	39.22396128	-121.7128855	310	12	70	24	1800	25.71	5,156.23	6,874.97	2	220	23	31
WCR2014-000439	None	39.13621383	-121.7856852	314	7	143	8	2300	16.08	3,225.15	4,300.20	2	220	15	20
WCR2008-007172	None	38.80380578	-121.6861789	320	10	80	8	3000	37.50	7,519.50	10,026.00	2	220	34	46
WCR2012-000138	HWY 20 & FARMLAN RD	39.1455556	-121.8905556	331	12	104	8	2700	25.96	5,205.81	6,941.08	2	220	24	32
WCR2019-007521	O W butte RD	39.1482831	-121.8262629	335	25	80	14	1000	12.50	2,506.50	3,342.00	2	220	11	15
WCR1994-005254	11727 N BUTTE RD	39.29649	-121.84514	340	30	108	10	2500	23.15	4,641.67	6,188.89	2	220	21	28
WCR2013-000532	9030 PASS RD	39.17992208	-121.7767283	340	31	130	4	160	1.23	246.79	329.06	2	220	1	1
WCR2014-000442	13030 MORONI RD	39.10630238	-121.8571684	378	8	70	48	2000	28.57	5,729.14	7,638.86	2	220	26	35
WCR2012-001199	None	38.8874419	-121.7870027	390	12	88	10	2800	31.82	6,380.18	8,506.91	2	220	29	39
WCR2013-000109	MOREHEAD RD	39.1505556	-121.8044444	400	12	86	52	1400	16.28	3,264.28	4,352.37	2	220	15	20
WCR2009-001078	14561 N BUTTE RD	39.30070686	-121.8962089	403	7	95	45	3500	36.84	7,387.58	9,850.11	2	220	34	45

Wells Completed in Aquifer Zone 3

Well Number	Well Location	Latitude	Longitude	Total Depth	Static Water Level	Total Drawdown	Pump Test Length	Pumping Rate	Specific Capacity	T (x200.52)	T (x 267.36)	Aquifer Zone	Thickness	K		
				Feet BGS	Feet BGS	Feet BGS	Hour	GPM	GPM/Ft	Ft2/Day	Ft2/Day		Ft	ft/day		
														x 1500	x 2000	
WCR1995-001276	2787 ENNIS RD	39.08724284	-121.8098937	480	12	129	6	2514	19.49	3,907.81	5,210.41	3	220	18	24	
WCR1995-001273	GARMIRE RD	39.06307	-121.82819	480	7	76	6	3008	39.58	7,936.37	10,581.83	3	220	36	48	
WCR2011-000310	8887 BIGELOW RD	39.29005432	-121.7781939	515	None	95	25	3300	34.74	6,965.43	9,287.24	3	220	32	42	
WCR2020-007645	None	38.993562	-121.785879	600	12.8	90.9	12	4000	44.00	8,823.76	11,765.02	3	220	40	53	
WCR2020-007653	None	38.985528	-121.7525	610	12.7	113.6	12	3800	33.45	6,707.54	8,943.38	3	220	30	41	
WCR2020-006713	None	38.990364	-121.782893	610	12	81	8	4200	51.85	10,397.33	13,863.11	3	220	47	63	
WCR2020-007067	None	38.987121	-121.778275	630	10.1	87.4	24	5500	62.93	12,618.54	16,824.71	3	220	57	76	
WCR2009-001108	None	39.25665072	-121.7146216	680	16	100	20	3700	37.00	7,419.24	9,892.32	3	220	34	45	
WCR1998-003770	PASS ROAD	39.19193	-121.93306	700	61	197	52	888	4.51	903.87	1,205.16	3	220	4	5	
WCR2010-002358	6900 S BUTTE RD	39.1494	-121.75397	930	9	98	37	2000	20.41	4,092.24	5,456.33	3	220	19	25	
									Average	35	6,977	9,303	-	-	32	42
									Median	36	7,192	9,590	-	-	33	44
									Maximum	63	12619	16825	-	-	57	76
									Minimum	4.51	904	1205	-	-	4	5

This page intentionally left blank.

Appendix 5-G
C2VSimFG-Sutter Model Report

This page intentionally left blank.

COMMITMENT & INTEGRITY
DRIVE RESULTS

801 T Street
Sacramento California 95811
www.woodardcurran.com

T 800.426.4262
T 916.999.8700
F 916.999.8701



C2VSIMFG - SUTTER

MODEL REPORT

December 2021

0011649.00
Sutter County

This page intentionally left blank.

TABLE OF CONTENTS

SECTION	PAGE NO.
1. INTRODUCTION.....	1
1.1 Goals of Model Development	1
1.2 Model Platform	1
1.3 Sutter Groundwater Subbasin	1
1.3.1 Sutter Subbasin in C2VSimFG-Sutter.....	5
2. MODEL ENHANCEMENTS	11
2.1 Historical Simulation Period.....	11
2.2 Initial Conditions	11
2.3 Irrigation Period	13
2.4 Reuse and Return Flow.....	13
2.5 Pondered Crop Inputs.....	14
2.6 Surface Water Diversions.....	14
2.6.1 New Diversions.....	15
2.6.1.1 Diversions by USBR Contractors	16
2.6.1.2 Diversions by DWR Projects	16
2.6.1.3 Other Diverters	16
2.6.2 Revised Diversions	16
3. MODEL CALIBRATION.....	19
3.1 Calibration of the IDC and Root Zone Parameters	19
3.2 Calibration of Aquifer Parameters	19
3.3 Calibration of Water Budgets.....	20
3.4 Streamflow Calibration	23
3.5 Groundwater Level Calibration	26
3.5.1 Calibration Statistics	29
3.6 Sensitivity Analysis	30
4. FUTURE REFINEMENTS	33
5. REFERENCES.....	34

TABLES

- Table 1: Average Monthly Ponding Depths Updated in C2VSimFG-Sutter
- Table 2: Diversions Added to C2VSimFG-Sutter
- Table 3: Diversions in C2VSimFG v1.0 Revised for C2VSimFG-Sutter
- Table 4: Summary of C2VSimFG-Sutter Aquifer Parameters
- Table 5: Summary of C2VSimFG-Sutter Streamflow Calibration Gages

FIGURES

- Figure 1: Location of the Sutter Subbasin
- Figure 2: Sutter Subbasin Boundaries
- Figure 3: C2VSimFG v1.0 Model Area
- Figure 4: C2VSimFG-Sutter Model Elements
- Figure 5: C2VSimFG-Sutter Model Nodes
- Figure 6: C2VSimFG-Sutter Streams
- Figure 7: C2VSimFG-Sutter Subareas
- Figure 8: Fall 1985 Initial Groundwater Head (Average of Layers 1-4)
- Figure 9: Return Flow Fractions in C2VSimFG-Sutter
- Figure 10: Sutter Subbasin Urban Land and Water Use Budget
- Figure 11: Sutter Subbasin Agricultural Land and Water Use Budget
- Figure 12: Sutter Subbasin Groundwater Budget
- Figure 13: Stream Gage Locations with Stream Node ID Labeled
- Figure 14: Sacramento River at Verona Simulated and Observed Stream Flows (Stream Node 4146)
- Figure 15: Sacramento River Below Wilkins Slough Simulated and Observed Stream Flows (Stream Node 3554)
- Figure 16: Hydrographs for Selected Calibration Wells
- Figure 17: Residual Histogram of C2VSimFG-Sutter Observations within Sutter Subbasin
- Figure 18: Scatter Plot of C2VSimFG-Sutter Observations within Sutter Subbasin
- Figure 19: Relative Differences in Residuals with Changing Aquifer Parameter
- Figure 20: Relative Differences in Residuals with Changing Soil Parameters

1. INTRODUCTION

1.1 Goals of Model Development

The C2VSimFG-Sutter model was designed to be used for groundwater management planning activities associated with the Sutter Subbasin Groundwater Sustainability Plan (GSP) to fulfill requirements under the Sustainable Groundwater Management Act (SGMA).

The C2VSimFG-Sutter model uses the C2VSimFG v1.0 released December 2020 with updates to better represent local conditions. C2VSimFG-Sutter runs the entire C2VSimFG model, but with data updates and calibration focused only on the area within and immediately surrounding Sutter Subbasin (Subbasin). The Subbasin plus a five-mile buffer was chosen as the calibration area for C2VSimFG-Sutter.

Unless specifically stated in this report, the C2VSimFG-Sutter model uses data from the C2VSimFG v1.0. The data and calibration of C2VSimFG v1.0 is described in a separate document (SGMO, 2020).

1.2 Model Platform

The C2VSimFG-Sutter model is a locally enhanced version of DWR's California Central Valley Groundwater-Surface Water Simulation Model (C2VSim) fine grid version 1.0. This version of the model was updated by DWR to support SGMA activities throughout the Central Valley at the regional scale (SGMO, 2020). The decision to use a locally refined version of C2VSimFG for Sutter Subbasin's SGMA effort was made based on the high degree of regional calibration the model had already achieved as well as consistency in methodology with groundwater planning efforts in surrounding subbasins.

IWFM is an open-source, finite element simulation code that supports triangular and quadrilateral elements (Dogrul, Kadir, & Brush, 2021). It was specifically designated in GSP regulations as being supported by DWR for water budget development and SGMA compliance.

The IWFM Demand Calculator (IDC) is the stand-alone root zone component of IWFM that simulates land surface and root zone flow processes (Dogrul, Kadir, & Brush, 2021). It calculates agricultural and urban water demands using inputs including climate conditions, soil parameters, and land use types and distribution. It can be run separately or combined with IWFM. IDC data development and results in this documentation are included as part of all other IWFM datasets and results.

1.3 Sutter Groundwater Subbasin

The Sutter Subbasin (5-021.62) is located in the Sacramento Valley Groundwater Basin and adjoins the following seven subbasins: Butte, Wyandotte, North Yuba, South Yuba, North American, Yolo, and Colusa (Figure 1). The northern boundary of the Sutter Subbasin consists of the Sutter County-Butte County line, except for the portion of Biggs-West Gridley Water District Groundwater Sustainability Agency (GSA) within Sutter County that is included within the Butte Subbasin. The eastern boundary consists primarily of the Sutter County-Yuba County line to its terminus just north of Nicolaus Census Designated Place (CDP), where the Feather River forms Sutter Subbasin's eastern boundary until the Feather River reaches the Yolo County line. The southern and western boundaries of the Sutter Subbasin follow the Sutter County boundary shared with Yolo and Colusa Counties (Figure 2).

The Sutter Subbasin is located within the Sacramento River watershed, which is bounded on the west by the Sacramento River and east by the Feather River (Wood Rodgers, 2012). The Sacramento River watershed includes tributaries originating in the Sierra Nevada, the Coast Range, and the Cascade Mountains. The major tributary to the Sacramento River that impacts surface water supplies within the Sutter Subbasin is Feather River.

The Sacramento River is the major surface water feature within the Sutter Subbasin, defining the western boundary of the Sutter Subbasin with the Butte, Colusa, and Yolo Subbasins. Running north-south along the western part of the Subbasin, the Sacramento River is the main drainage for the Sacramento Valley watershed on its way to the Sacramento-San Joaquin Delta and San Francisco Bay.

The Feather River is a major tributary of the Sacramento River and outlines Sutter Subbasin's eastern boundary shared with the North Yuba and South Yuba Subbasins. The river trends north-south along the northern and central portions of the Subbasin to the convergence with the Bear River, where it changes course and flows southwest through the south-central portion of the County until it intersects the Sutter Bypass and the Sacramento River.

The Sutter Bypass is another major surface water feature in the Sutter Subbasin. It is an artificial flood corridor constructed in the 1930s. Flows enter the bypass in the Butte Basin near the town of Colusa, running South through the center of Sutter Subbasin and flow out to the Sacramento River and Feather River at the southern tip of the Subbasin. During periods of heavy precipitation and runoff, a portion of the flow within the Sacramento River is diverted through the Sutter Bypass to alleviate the flood control system along the Sacramento River.

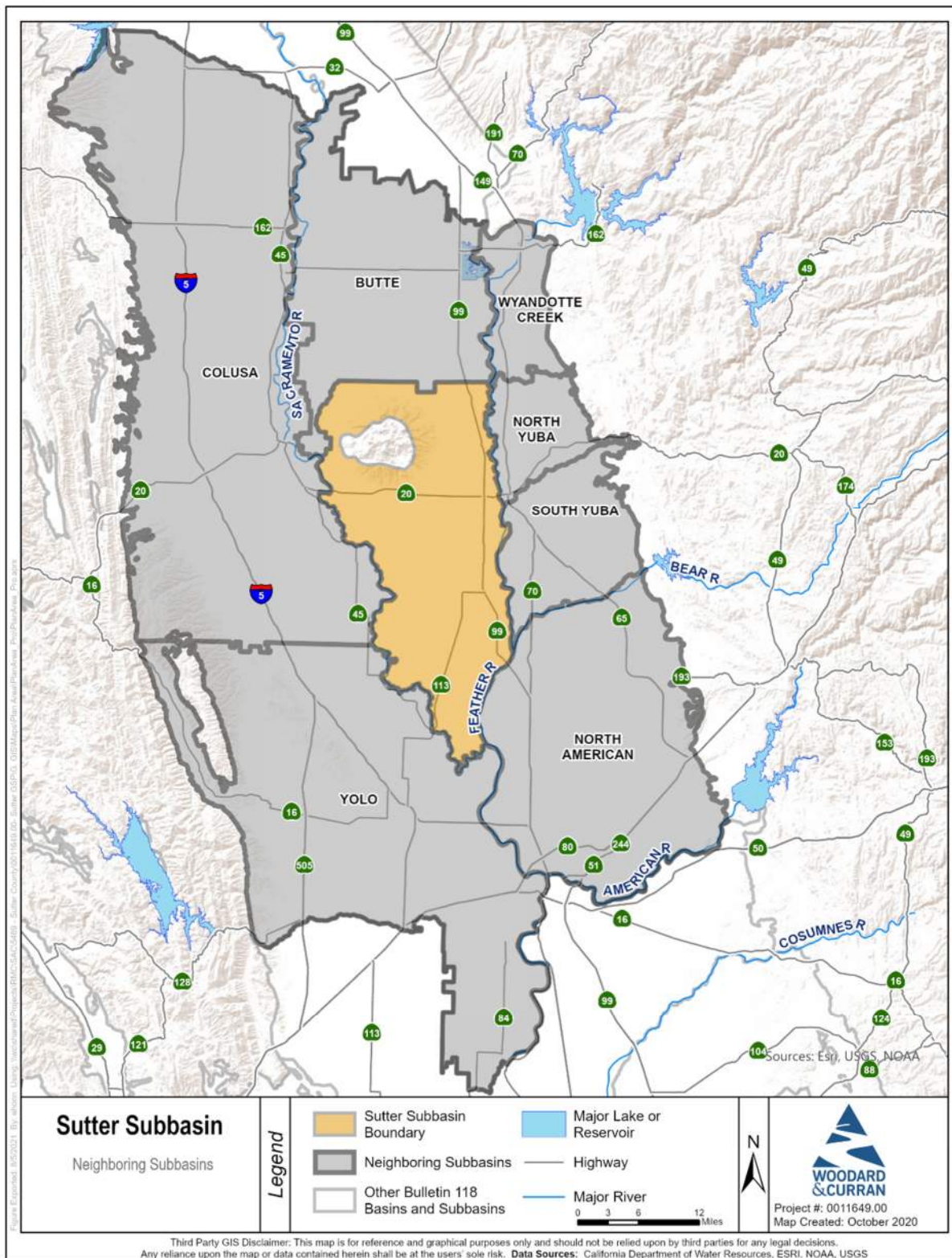

Figure 1: Location of the Sutter Subbasin



Figure 2: Sutter Subbasin Boundaries

1.3.1 Sutter Subbasin in C2VSimFG-Sutter

Sutter Subbasin lies within C2VSimFG Subregions 4 and 5 with the Sutter Bypass making up the subregion border (Figure 3).

The finite element grid of the C2VSimFG-Sutter is unchanged from C2VSimFG v1.0. The model grid contains 32,537 elements and 30,179 groundwater nodes with an average element area of 0.64 square miles (Figure 4 and Figure 5). The total area of the model is 20,742 square miles and contains 4 stratigraphic layers. Calibration of C2VSimFG-Sutter was focused on the area within a 5-mile buffer of the Subbasin, an area which totaled 1,070 square miles, covering 2,555 elements and 2,309 groundwater nodes. 4,634 stream nodes characterize the surface water hydrology within the model with 498 stream nodes within the calibration area. Simulated streams are shown in Figure 6..

The C2VSimFG-Sutter calibration area model elements are grouped into 23 model subareas that are used to analyze model results and confirm input data. Subarea borders were delineated using boundaries including city spheres of influence, water agencies, subbasin, and county lines. These areas are shown in Figure 7. The area between the Subbasin boundary and the five-mile buffer boundary was considered an additional subarea during calibration.

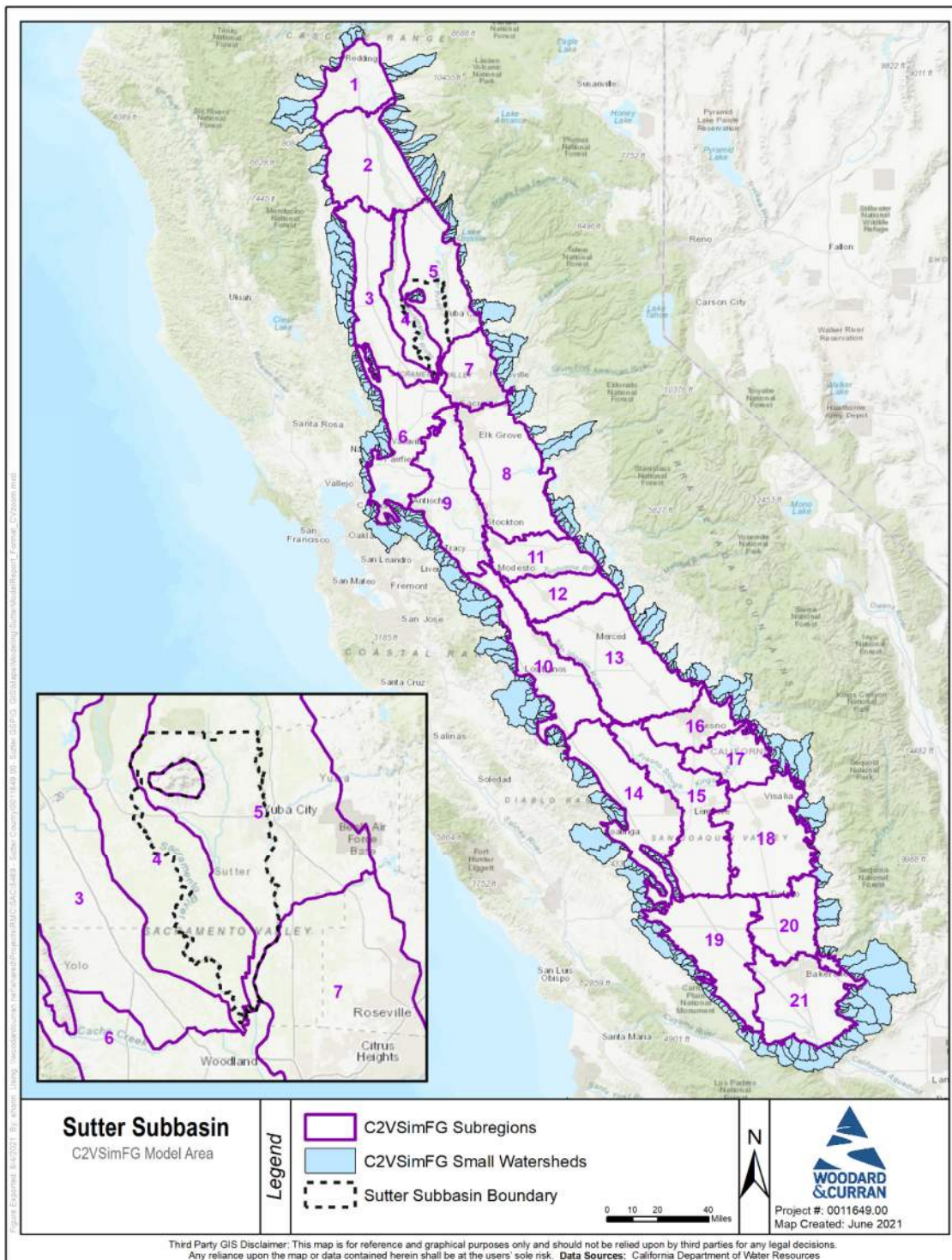

Figure 3: C2VSimFG v1.0 Model Area

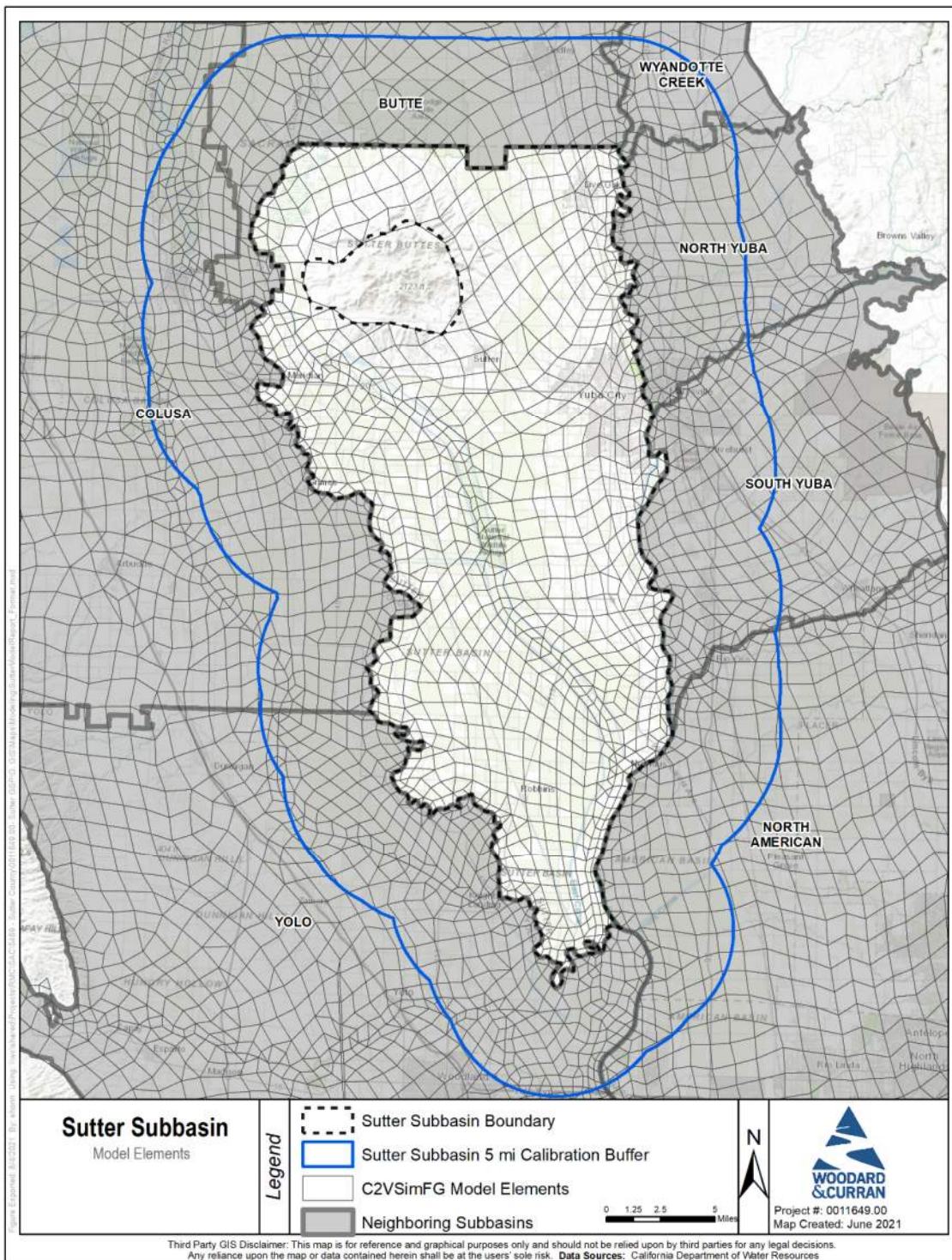

Figure 4: C2VSimFG-Sutter Model Elements

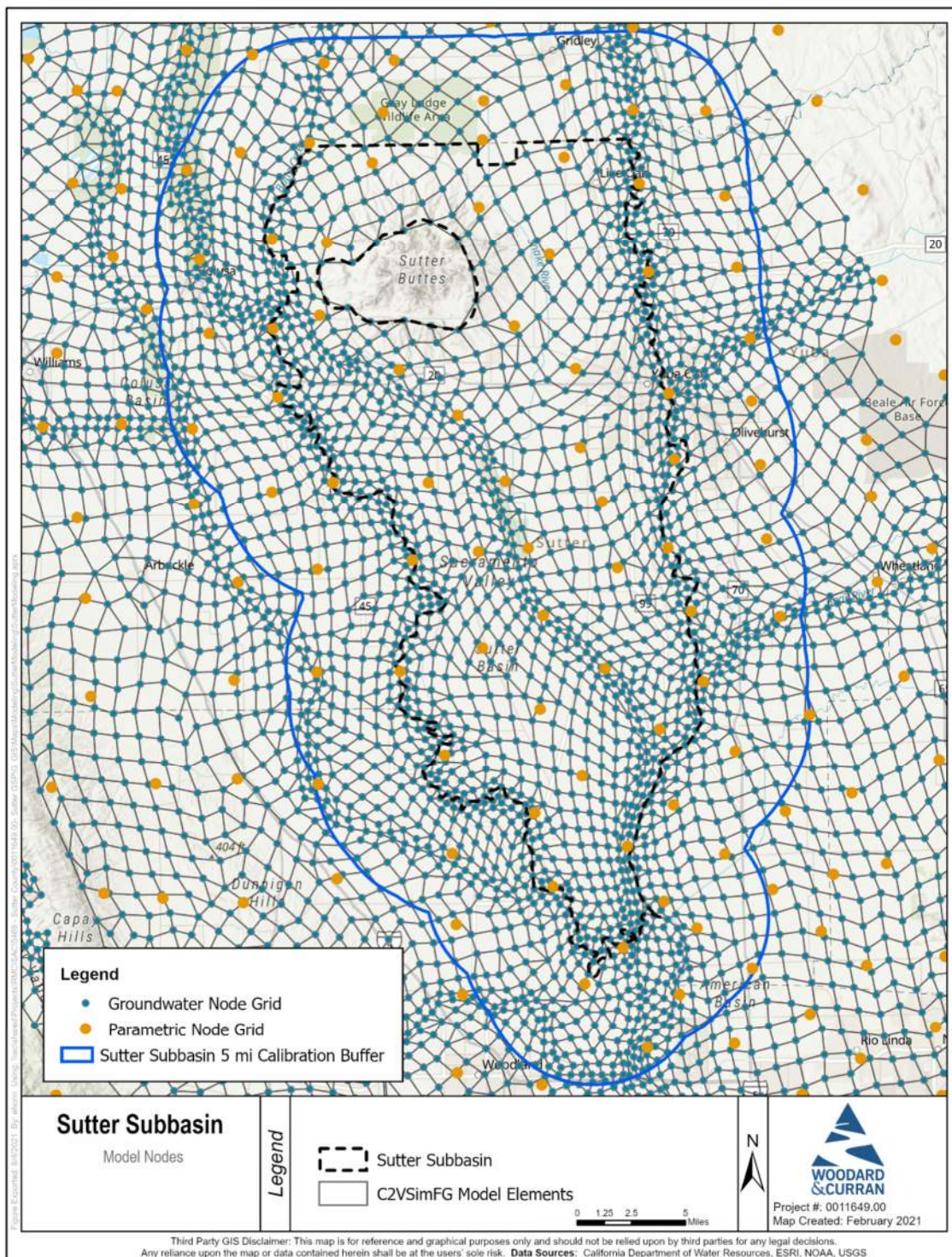

Figure 5: C2VSimFG-Sutter Model Nodes

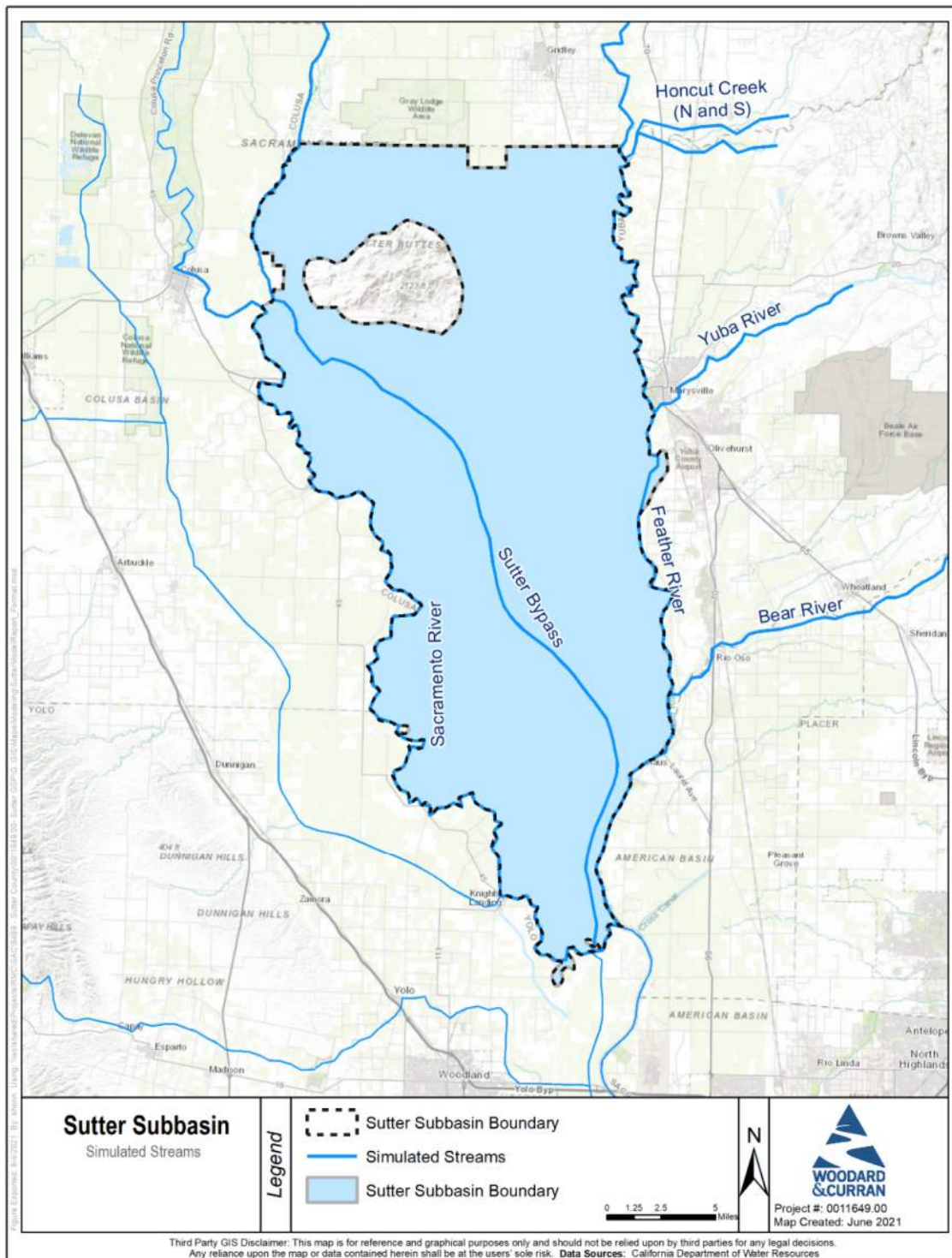

Figure 6: C2VSimFG-Sutter Streams

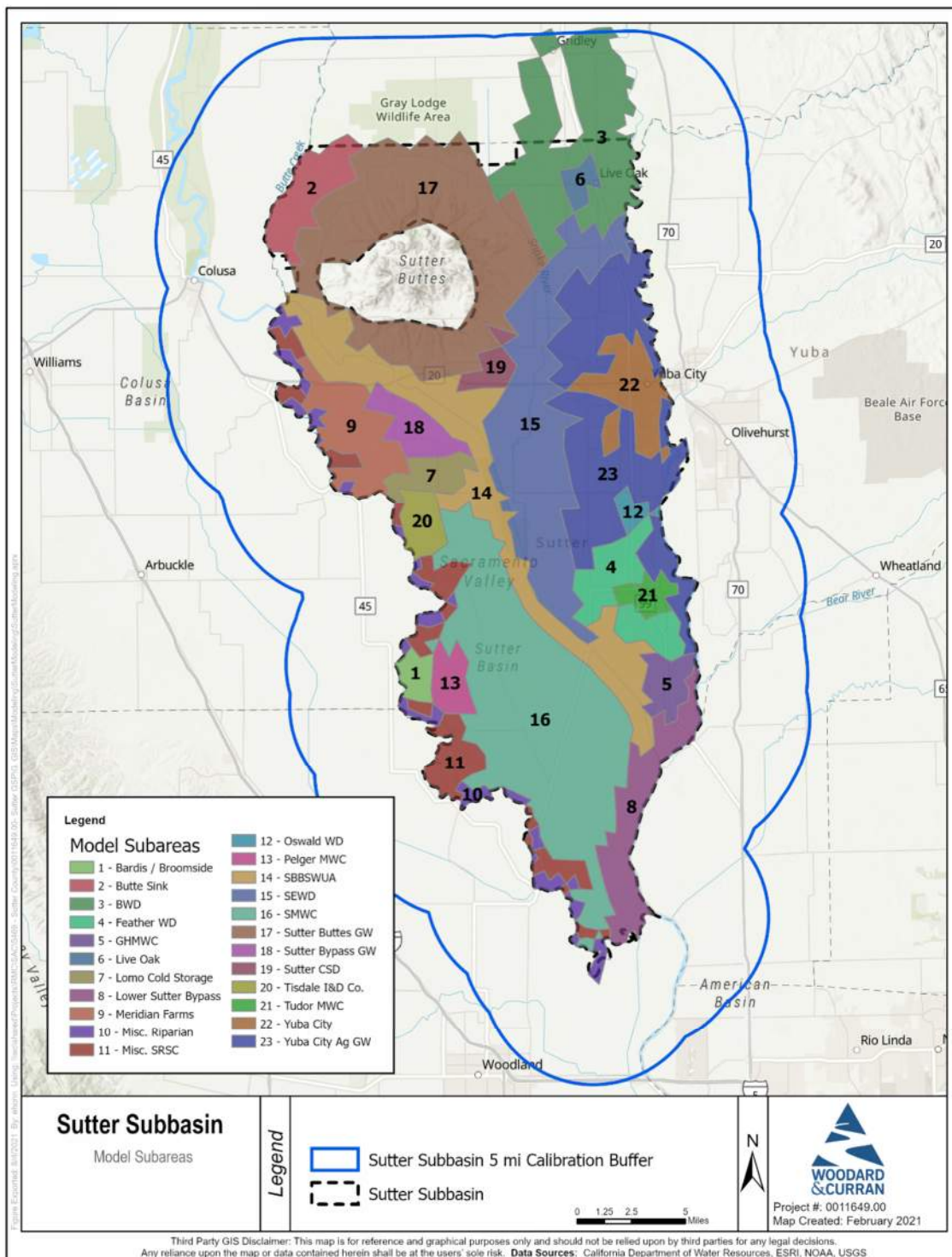

Figure 7: C2VSimFG-Sutter Subareas

2. MODEL ENHANCEMENTS

Specific enhancements made to C2VSimFG v1.0 include changes to the simulation period, initial groundwater elevation, soil properties, irrigation period, irrigation operations and efficiency, and surface water diversions. These changes are described in the sections below. Other changes made to calibrate specific root zone, stream, and aquifer characteristics are discussed further in Section 3. Unless otherwise noted, other inputs to the C2VSimFG v1.0 model were generally used directly in the C2VSimFG-Sutter model.

2.1 Historical Simulation Period

The historical C2VSimFG-Sutter simulates water years 1986 through 2015 (October 1, 1985 through September 30, 2015). All data and computations are performed on a monthly time step.

2.2 Initial Conditions

Initial groundwater elevations were updated to Fall 1985 to reflect a simulation start date of October 1, 1985. Groundwater elevations for Fall 1985 for each model node and each layer were first extracted from C2VSimFG v1.0 simulation results. These groundwater elevations were then compared to observed measurements at groundwater well locations. Areas where there was disagreement between the regional model simulated head and observed values were updated based on DWR's WDL database. To capture the most representative local conditions in the mid-1980s, the average of all measurements taken between 1984 and 1988 was interpolated to create a continuous surface raster from which groundwater elevations could be extracted at node locations. Differences in head between model layers was preserved from the C2VSimFG v1.0 simulated groundwater elevations. The groundwater level initial conditions for C2VSimFG-Sutter representing October 1985 are shown in Figure 8.

Initial soil moisture conditions for native vegetation, urban areas, and agricultural land was also updated to reflect the 1985 simulation start date.

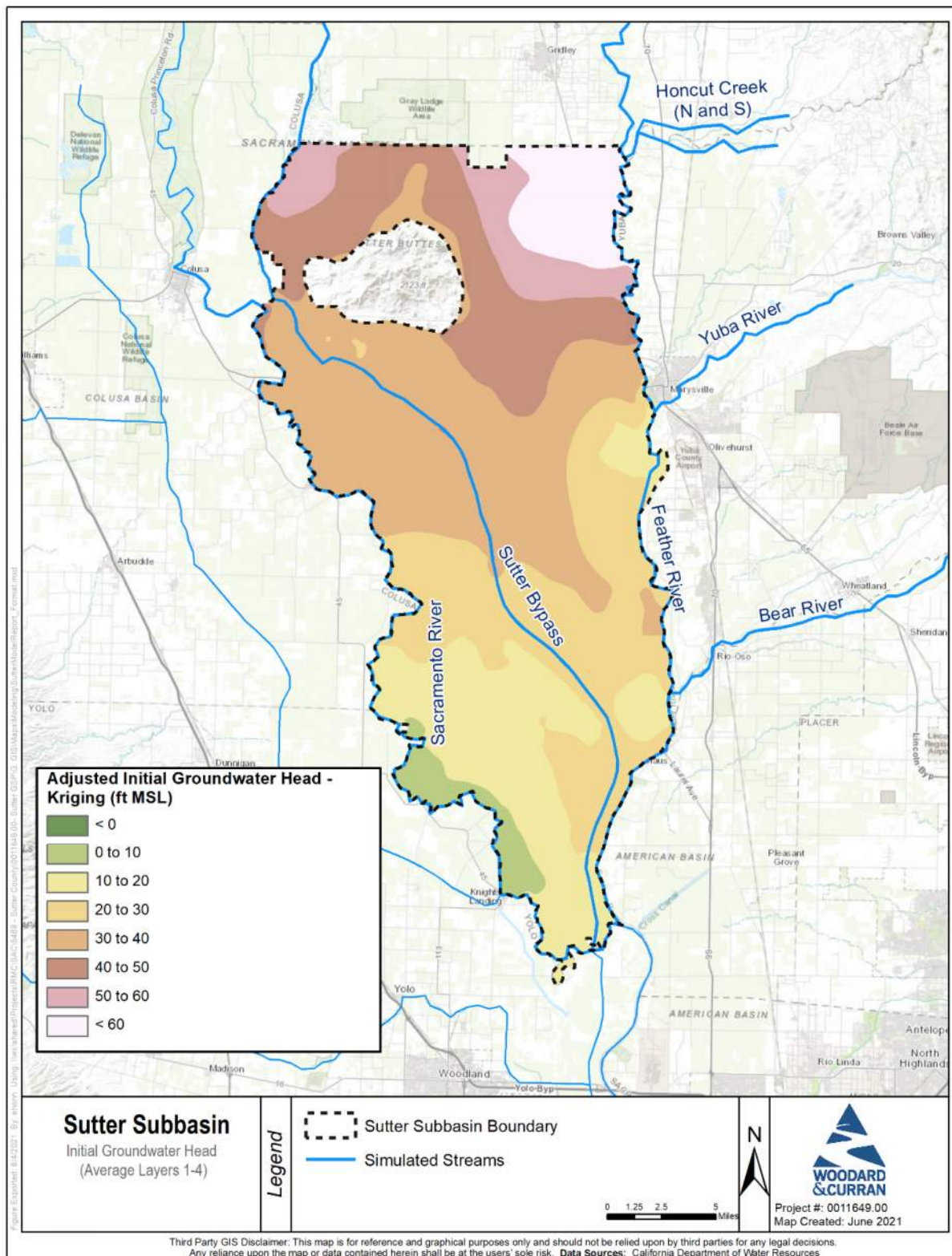

Figure 8: Fall 1985 Initial Groundwater Head (Average of Layers 1-4)

2.3 Irrigation Period

The irrigation period identifies the months during which irrigation is available to a crop or land use class. A value of one designates a month during which IDC calculates applied water demand for the land use class and simulates irrigation events, as needed. A value of zero designates a non-irrigation month during which IDC does not compute applied water and does not simulate irrigation for the land use class. Different monthly designations can be defined for different land use classes, if necessary.

In C2VSimFG-Sutter, the irrigation period was defined through time series inputs corresponding to typical crop irrigation seasons in the Sutter Subbasin. The irrigation period was also refined for rice in select months in order to better match the timing of planting and application of water in the winter months, according to local agricultural practices.

The irrigation periods were developed in conjunction with crop evapotranspiration (ETc) values that were derived from remote sensing analysis. The ETc values that were selected for use in the final modeling were not the same ETc values used to configure the irrigation periods. The selected ETc values were taken from C2VSimFG v1.0. The actual ET calculated in the model depends on both the irrigation period and ETc. It is recommended that these values be reviewed in future updates.

2.4 Reuse and Return Flow

The return flow fraction determines the proportion of applied water that can leave the land use area as runoff, while the reuse fraction determines the proportion of applied water that is captured and reused for irrigation. A value of one for each indicates that all applied water can leave as runoff, but that all applied water is captured and reused for irrigation. A value of zero for each indicates that no applied water leaves the land use cell, and that no water is reused for irrigation.

In C2VSimFG-Sutter, irrigation water return flow fractions were converted to timeseries inputs for all crops, with decreasing values that reflect changes in local irrigation practices over time, leading to reductions in runoff (Figure 9). Irrigation reuse fractions were unchanged from C2VSimFG v1.0, with values of 0 set for all crops.

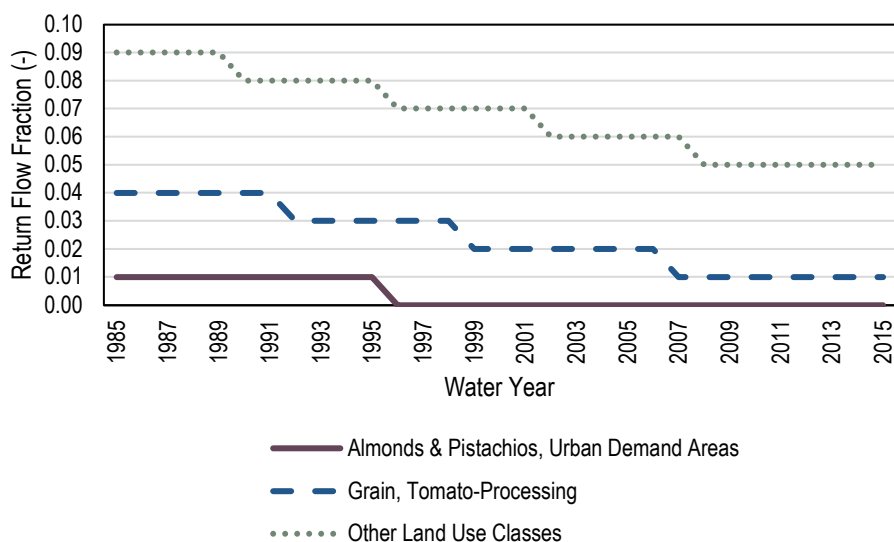

Figure 9: Return Flow Fractions in C2VSimFG-Sutter

2.5 Poned Crop Inputs

Ponding depth inputs to the model dictate the amount of water that is applied to ponded crops during irrigation. Monthly ponding depths for rice with flooded decomposition was refined in C2VSimFG-Sutter to more accurately match early and late-season water application rates in the Sutter Subbasin in recent years (Table 1). Other ponded depths were unchanged from the standard C2VSimFG v1.0 inputs.

Table 1: Average Monthly Ponding Depths Updated in C2VSimFG-Sutter

Month	Average Ponding Depth by Crop Type (ft; 1990-2015 Average)	
	Rice with Flooded Decomposition	Rice with No Decomposition
1	0.15	0.00
2	0.02	0.00
3	0.00	0.00
4	0.01	0.02
5	0.34	0.35
6	0.38	0.38
7	0.35	0.35
8	0.25	0.25
9	0.01	0.03
10	0.09	0.00
11	0.32	0.00
12	0.26	0.00

2.6 Surface Water Diversions

Diversions are specified in C2VSimFG-Sutter to quantify the volume of water available for deliveries to specific land use areas in the Sutter Subbasin. The diversion specifications are also used by the model to quantify the volumes of nonrecoverable loss to the atmosphere through evaporation and recoverable loss to the groundwater system through seepage (infiltration of surface water).

Diversions that are used within the Sutter Subbasin are generally quantified based on outside data sources, including: delivery records reported by the United States Bureau of Reclamation (USBR), delivery records from the State Water Project (SWP), groundwater management or water planning documents developed by water agencies including the Feather River Regional Agricultural Water Management Plan (FRRAWMP), data obtained directly from districts, and publicly available records maintained by the California State Water Resources Control Board (SWRCB) in the Electronic Water Rights Information Management System (eWRIMS). Some diversions were also based on modeled demand. Data sources and updates to specific diversion volumes and specifications are described below.

Diversions of supply used outside the Subbasin are generally assumed to be equal to diversions data specified in C2VSimFG v1.0. Deliveries are generally calculated by C2VSimFG-Sutter as the water supply used to meet simulated crop water demands, after accounting for seepage and evaporation of the diverted supply.

All diversions to lands entirely within the Sutter Subbasin in C2VSimFG v1.0 were removed from the model (i.e. turned off). New diversions were added to C2VSimFG-Sutter for diverters entirely within the Sutter Subbasin. Detail regarding added and revised diversions are described in the sections below.

2.6.1 New Diversions

New diversions were added to C2VSimFG-Sutter to specify monthly deliveries to individual Central Valley Project (CVP) contractors, SWP diverters, and other diverters within the Sutter Subbasin. While many diversions were specified in C2VSimFG v1.0, the original model largely aggregated the diversion volumes and element groups across multiple diverters. The new diversions were specified to instead distinguish the diversion volume and distribution area for each of the major diverters.

Diversion data were downloaded from USBR for all diverters that receive water from the Sacramento River, and other CVP supplies. Diversion data were downloaded from SWP Bulletin 132 for historical years for all diverters that receive water from these projects. Diversion data from other sources were downloaded from eWRIMS, from FRRAWMP records, or were obtained from the district. Monthly data were quality controlled and reviewed for consistency. Where data were estimated, a monthly average was calculated and used for estimated years. The point of diversion was estimated to be the stream node closest to the element(s) where diversions were applied, as identified from GIS data and satellite imagery.

The diversion specifications were updated for all new deliveries. The recoverable and nonrecoverable loss fraction of each new diversion was updated based on local water budget information, where available. The volumes of diversions from these sources added to C2VSimFG-Sutter are listed in **Table 2** in years when data were available (1985-2015).

Table 2: Diversions Added to C2VSimFG-Sutter

Diversion ID	Description	Data Source	Average Diversion Volume (AF per year, 1990-2015)
491	Bardis, Broomside, Cranmore Farms	USBR delivery reports (1994-2015); estimated other years	5,877
492	Butte Sink	Estimated based on modeled demand (1985-2015)	19,138
493	Thermalito Afterbay to Butte Water District	FRRAWMP (1985-2014); estimated other year	100,537
494	Feather Water District	SWP delivery reports (1985-2012); eWRIMS (2013,2015); estimated other year	8,886
495	Garden Highway Mutual Water Company	SWP delivery reports (1991-2015); estimated other years	14,294
496	Lomo Cold Storage	USBR delivery reports (1989-1993, 2001-2015); estimated other years	3,345
497	Lower Sutter Bypass	Estimated based on modeled demand (1985-2015)	23,403
498	Meridian Farms	USBR delivery reports (1985-2015)	24,762
499	Misc. Riparian	Estimated based on modeled demand (1985-2015)	8,319

Diversion ID	Description	Data Source	Average Diversion Volume (AF per year, 1990-2015)
500	Misc. Sacramento River Settlement Contractors	Estimated based on modeled demand (1985-2015)	18,728
501	Oswald Water District	SWP delivery reports (1985-2015)	942
502	Pelger Mutual Water Company	USBR delivery reports (1985-2015)	4,492
503	Sutter-Butte Butte Slough WUA	Estimated based on modeled demand (1985-2015)	62,070
504	Thermalito Afterbay to Sutter Extension Water District	FRRAWMP (1985-2015)	147,172
505	Sutter Mutual Water Company	USBR delivery reports (1985-2015)	188,934
506	Tisdale Irrigation & Drainage Company	USBR delivery reports (1985-2015)	6,648
507	Tudor Mutual Water Company	SWP delivery reports (1985-2015); estimated other years	3,153
508	Yuba City	Yuba City delivery records (1990-2015); estimated other years	12,968

2.6.1.1 Diversions by USBR Contractors

Diversions to Bardis, Broomside and Cranmore Farms (1994-2015), Lomo Cold Storage (1989-1993, 2001-2015), Meridian Farms (1985-2015), Pelger MWC (1985-2015), Sutter MWC (1985-2015), and Tisdale Irrigation and Drainage Co. (1985-2015) were updated with diversion data available from USBR (1985-2015).

2.6.1.2 Diversions by DWR Projects

DWR diversions were aggregated from data in the SWP Bulletin 132 for historical years. Diversions to Feather Water District were updated with diversion data available from the SWP (1985-2012), and with eWRIMS data for years which did not have SWP reported data available (2013, 2015). Diversions to Garden Highway MWC (1991-2015), Oswald WD (1985-2015), and Tudor MWC (1985-2015) were also updated with diversion data available from the SWP and estimated as a monthly average for remaining years in the model simulation.

2.6.1.3 Other Diverters

All other diversions were either obtained from local water records and planning documents, were obtained directly from districts, or were estimated based on modeled demand. Diversion data for both Butte WD and Sutter Extension WD from the Thermalito Afterbay were updated from the FRRAWMP. Diversions to Yuba City were updated with diversion records obtained directly from the City. For Butte Sink, Lower Sutter Bypass, Misc. Riparian and Misc. SRSC, and Sutter-Butte Butte Slough WUA, water use was based on modeled demand. The model was run to calculate the demand for these riparian areas. The amount of pumping for each of these areas was replaced with the same amount of diversion and the model was run again for final diversion quantities.

2.6.2 Revised Diversions

For diversions to lands partially within and partially outside the Subbasin, diversions were adjusted to deliver water only outside the subbasin and the diversion amount was prorated based on the relative area outside the Subbasin. Diversion specifications were revised for existing diversions, if needed. Distribution and recharge element groups were

revised to match the diverter's service area. Changes in how the diversions are distributed inside and outside the Sutter Subbasin were refined to exclude areas within or outside of the Subbasin, as needed. Table 3 identifies diversions originally in C2VSimFG v1.0 that were changed in C2VSimFG-Sutter.

Table 3: Diversions in C2VSimFG v1.0 Revised for C2VSimFG-Sutter

Diversion ID	Description in C2VSimFG v1.0	Revision in C2VSimFG-Sutter
52	Little Dry Creek to Richvale Irrigation District for Ag (11_SA2)	Maximum diversion amount set to 70% of original value
59	Feather River via Western Canal to Western Canal WD for Ag (11_SA1)	Maximum diversion amount set to 70% of original value
60	Feather River via Joint Board Canal to Gray Lodge Wildlife Area (17N_PR)	Maximum diversion amount set to 70% of original value
61	Feather River via Joint Board Canal to Biggs-West-Gridley WD and Butte WD for Ag (11_SA3)	Maximum diversion amount set to 70% of original value
62	Feather River via Richvale Canal - Buttler Canal to Richvale ID for Ag (11_SA2)	Maximum diversion amount set to 70% of original value
63	Thermalito Afterbay via Western Canal to Western Canal WD for Ag (11_SA1)	Maximum diversion amount set to 70% of original value
64	Thermalito Afterbay via Joint Board Canal to Gray Lodge Wildlife Area (17N_PR)	Maximum diversion amount set to 70% of original value
65	Thermalito Afterbay via Joint Board Canal to Biggs-West-Gridley WD and Butte WD for Ag (11_SA3)	Maximum diversion amount set to 70% of original value
66	Thermalito Afterbay via Richvale Canal - Buttler Canal to Richvale ID for Ag (11_SA2)	Maximum diversion amount set to 70% of original value
67	Thermalito Afterbay via Western Canal to Upper Butte Basin Wildlife Area – Howard Slough Unit (11_PR)	Maximum diversion amount set to 70% of original value
68	Thermalito Afterbay via Richvale Canal - Buttler Canal to Upper Butte Basin Wildlife Area – Little Dry Creek Unit (11_PR)	Maximum diversion amount set to 70% of original value
71	Feather River RM 39 (Sunset Pumps) via Sutter-Butte Extension Canal to Sutter Extension WD for Ag (11_SA4)	Maximum diversion amount set to 70% of original value
72	Feather River RM 39 (Sunset Pumps) via Sutter-Butte Extension Canal to Sutter NWR (17S_PR)	Maximum diversion amount set to 70% of original value
73	Feather River RM 31 to City of Yuba City WTP for Urban (16_PU)	Diversion no longer used*
75	Feather River RM 21 to Feather WD for Ag (16_PA)	Diversion no longer used*
76	Feather River RM 21 to Garden Highway Mutual Water Company for Ag (16_SA)	Diversion no longer used*
78	Feather River RM 18 to Tudor ID for Ag (16_SA)	Diversion no longer used*
79	Feather River to Oswald WD for Ag (16_SA)	Diversion no longer used*
80	Feather River RM 8 to minor riparian and appropriate diversions for Ag (16_SA)	Diversion no longer used*
81	Feather River RM 3 to miscellaneous RB diverters downstream of Niclaus Gage for Ag (17S_SA)	Diversion no longer used*
100	Butte Creek diversion by RD 1004 for Ag (09_SA2)	Maximum diversion amount set to 89% of original value

Diversion ID	Description in C2VSimFG v1.0	Revision in C2VSimFG-Sutter
101	Butte Slough to Miscellaneous Butte Slough diverters for Ag (18_NA)	Diversion no longer used*
102	Sutter Bypass West Borrow Pit to Butte Slough IC, part of Sutter Butte MWC, and non-district diverters for Ag (18_NA)	Diversion no longer used*
103	Sutter Bypass to Sutter NWR (17S_PR)	Diversion no longer used*
104	Sutter Bypass for Ag (17S_NA)	Diversion no longer used*
105	Sutter Bypass to lands within Sutter Bypass for Ag (11_NA)	Maximum diversion amount set to 55% of original value
106	Sutter Bypass for Ag (16_NA2)	Diversion no longer used*
115	Sacramento River LB diversions between Butte City and Colusa to RD 1004 (partial), Spence Ruth Ann (Spence Farms), Jane Cart	Maximum diversion amount set to 89% of original value
120	Sacramento River RM 136 miscellaneous non-CVP diversions for Ag (18_NA)	Diversion no longer used*
121	Sacramento River LB diversions between Colusa and Wilkins Slough to Tarke Stephen & Debra, Meridian Farms Water Company, Bev	Diversion no longer used*
123	Sacramento River LB diversions between Colusa and Wilkins Slough to Sutter MWC (94%), Oji Brothers Farm and miscellaneous se	Diversion no longer used*
125	Sacramento River LB diversions between Wilkins Slough and Knights Landing to Howald Farms, O'Brien Janice, Pelger MWC, Bardi	Diversion no longer used*
127	Sacramento River RB Miscellaneous non-CVP diversion for Ag (19_SA)	Diversion no longer used*
128	Sacramento River LB diversions between Wilkins Slough and Knights Landing to Sutter MWC (State Ranch Bend), Lockett, and mis	Diversion no longer used*
129	Sacramento River LB diversions between Knights Landing and Verona to MCM Properties, Sutter MWC, Byrd Anna C. & Osborne Jane	Diversion no longer used*
132	Sacramento River RM81 RB to miscellaneous non-project diverters for Ag (21_NA)	Maximum diversion amount set to 97% of original value

* All diversions to lands entirely within the Sutter Subbasin from C2VSimFG v1.0 were removed from the model (i.e. turned off). New diversions were added into C2VSimFG-Sutter for diverters entirely within the Sutter Subbasin.

3. MODEL CALIBRATION

The C2VSimFG-Sutter model was refined from C2VSimFG v1.0 through enhancements to specific model inputs, assumptions, and parameters related to the surface water and groundwater systems, discussed in the section above. Davids Engineering and Woodard & Curran refined and calibrated the surface and groundwater system water budgets for the portion of the model domain within and five miles surrounding the Sutter Subbasin. The calibration period is the same as the simulation of water years 1986 through 2015, though special focus was placed on the 26 years from 1990 through 2015.

3.1 Calibration of the IDC and Root Zone Parameters

Root zone parameters were refined, as needed, through an iterative process to determine reasonable agricultural demand and develop the components of a balanced root zone budget by C2VSimFG-Sutter subarea. This part of the calibration effort focused primarily on refining root zone parameters such as soil hydraulic conductivity (with separate values for rice and non-rice agricultural areas), pore size distribution index, and target soil moisture. These parameters were iteratively refined by comparing against information by hydrologic soil group and soil moisture by crop type due to differing irrigation practices.

Saturated soil hydraulic conductivity, the measurement of saturated soil's ability to transmit water, is used by C2VSimFG-Sutter to facilitate the movement of water through the root zone system. This parameter, especially for rice areas, was refined through the course of model calibration to allow the potential for more water applied to lands as part of rice growing operations to possibly percolate into the groundwater system. After refinements, the average soil hydraulic conductivity in the Sutter Subbasin is 0.007 feet per day for rice areas, ranging 0.005 to 0.03 feet per day. For non-rice areas, the soil hydraulic conductivity ranged from 0.02 to 1.21 feet per day with an average of 0.10 feet per day.

Pore size distribution index, which controls the overall distribution of flow channel sizes, is a typical calibration parameter that can control root zone system water movement. After refinements, the average pore size distribution index in the Sutter Subbasin is 0.36 (with a range of 0.02 to 1.211).

The TSM specifies the irrigation target soil moisture as a fraction of field capacity, and is used by C2VSimFG-Sutter to compute irrigation depths for each land use in the model domain. Target soil moisture fractions in the calibrated model range from 0.9 to 1.0 (i.e., 90 to 100 percent of field capacity) for rice, to values generally between 0.76 and 1.00 (i.e., 76 to 100 percent of field capacity) for other nonponded crops. These values approximate soil moisture resulting from common irrigation practices in the Sacramento Valley.

3.2 Calibration of Aquifer Parameters

C2VSimFG-Sutter was calibrated using a parametric grid that was developed based on C2VSim Coarse Grid (C2VSimCG) nodes and elements. The parametric grid nodes are spaced approximately 3.5 miles apart. Aquifer parameters are assigned to each parametric node and interpolated to the nearby C2VSimFG-Sutter groundwater nodes. Figure 5 shows the parametric grid nodes used to calibrate Sutter Subbasin. After regional calibration using the parametric grid, local calibration was made by changing aquifer parameters at each C2VSimFG-Sutter model node.

The initial aquifer parameters were from C2VSimFG v1.0 model. Through analysis of subregion water budgets and groundwater level hydrographs at the calibration wells, aquifer parameters were adjusted either model-wide or by node in particular areas. The parameters resulting from the calibration process are listed in Table 4.

Table 4: Summary of C2VSimFG-Sutter Aquifer Parameters

Layer	Horizontal Hydraulic Conductivity (ft/day)	Specific Storage (1/ft)	Specific Yield (-)	Aquifer Vertical Hydraulic Conductivity (ft/day)
1	4 – 92	9.12E-06 – 1.00E-05	3.17E-02 – 0.14	0.10 – 9.80
2	0 – 84	8.37E-06 – 1.00E-05	1.98E-05 – 0.15	0 – 9.84
3	0 – 64	9.70E-6 - 1.00E-05	1.89E-05 – 0.14	0 – 9.94
4	0 – 56	7.26E-06 – 1.00E-05	1.74E-05 – 0.17	0 – 9.97

The horizontal hydraulic conductivity in the C2VSimFG-Sutter varies across the horizontal direction and across model layers. The fully calibrated values for model layers 1 through 4 range from 0 ft/day to 92 ft/day.

The aquifer vertical hydraulic conductivity facilitates the separation between the unconfined and confined aquifers within the C2VSimFG-Sutter and controls the flow of groundwater between the materials making up the different modeled aquifer layers. Analysis of the groundwater levels in each layer for calibration wells (i.e., nested calibration wells spanning multiple layers) determined that greater separation between layers was needed in some areas and resulted in a range of 0 ft/day to about 10 ft/day across the model layers.

3.3 Calibration of Water Budgets

Many local agencies and districts develop their own water budgets in order to track and account for water demand and supply within their service areas. Local water budgets in Sutter Subbasin were compiled and analyzed as part of model calibration to evaluate how C2VSimFG-Sutter compares. To facilitate these comparisons, the historical C2VSimFG-Sutter 5-mile calibration area was divided into 23 subareas within the Subbasin, several of which represent the service areas of specific water agencies and organizations (Figure 7). The portion of the calibration area that is outside of the Subbasin, but within the 5-mile buffer was also examined.

The land use budget supply and demand was evaluated separately for agricultural and urban lands. Urban groundwater pumping, surface water deliveries, and demand are shown over the simulation period in Figure 10. Both supply and demand are lower in drier years and higher in wetter years. Water year types are from the Sacramento Valley Water Year Hydrologic Classification, which classifies water years 1901 through 2020 as wet, above normal, below normal, dry, and critical based on inflows to major reservoirs or lakes (DWR, 2021). Agricultural groundwater pumping and surface water deliveries includes both ponded crops (rice) and non-ponded crops (other crops besides rice) pumping and deliveries, shown in Figure 11. Supplies are shown as positive and demand is shown as negative in these figures.

The groundwater budget is shown in Figure 12 displaying the different inflows and outflows accounted for in C2VSimFG-Sutter’s groundwater system. Inflows include deep percolation (from rainfall or applied water), boundary inflows (from outside of the Sutter Subbasin, including flows from the Sutter Buttes), recharge from canal seepage, and inflow to the groundwater system. Outflows include outflow to streams, groundwater pumping, and net subsurface flow to other subbasins, which is predominantly flowing out of the Sutter Subbasin. Additionally, the annual change in groundwater storage is included and is either an inflow or an outflow depending on the year. The black line indicates the cumulative change in groundwater storage throughout the simulation period.

Deep percolation is the largest inflow with an annual average of 184 TAF and groundwater pumping is the largest annual outflow with 135 TAF on average. Losses of groundwater to the stream system (Sacramento River, Feather River, or Sutter Bypass) are estimated to be 81 TAF on average annually. As shown in the land use budgets, the majority of this groundwater pumping is for agricultural use.

Overall, the annual average change in groundwater storage is about 4,500 AF. Over time, this results in a net loss in groundwater storage of 146 TAF over the 30 years of the C2VSimFG-Sutter simulation.

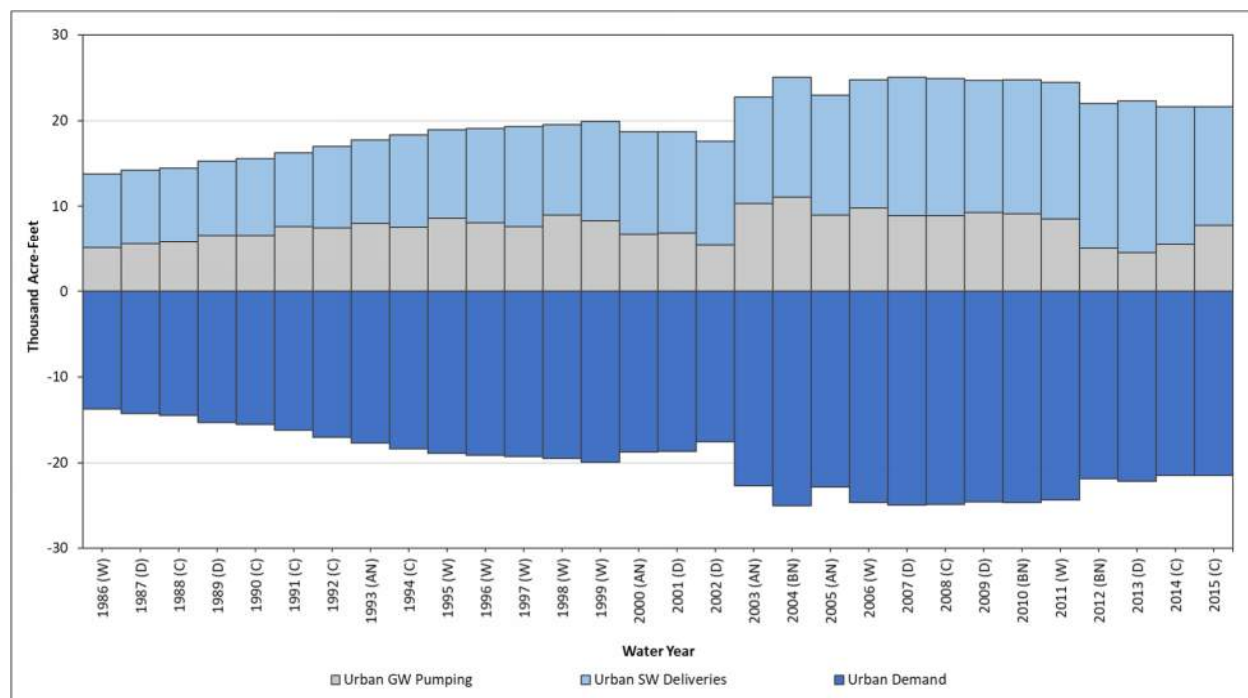

Figure 10: Sutter Subbasin Urban Land and Water Use Budget

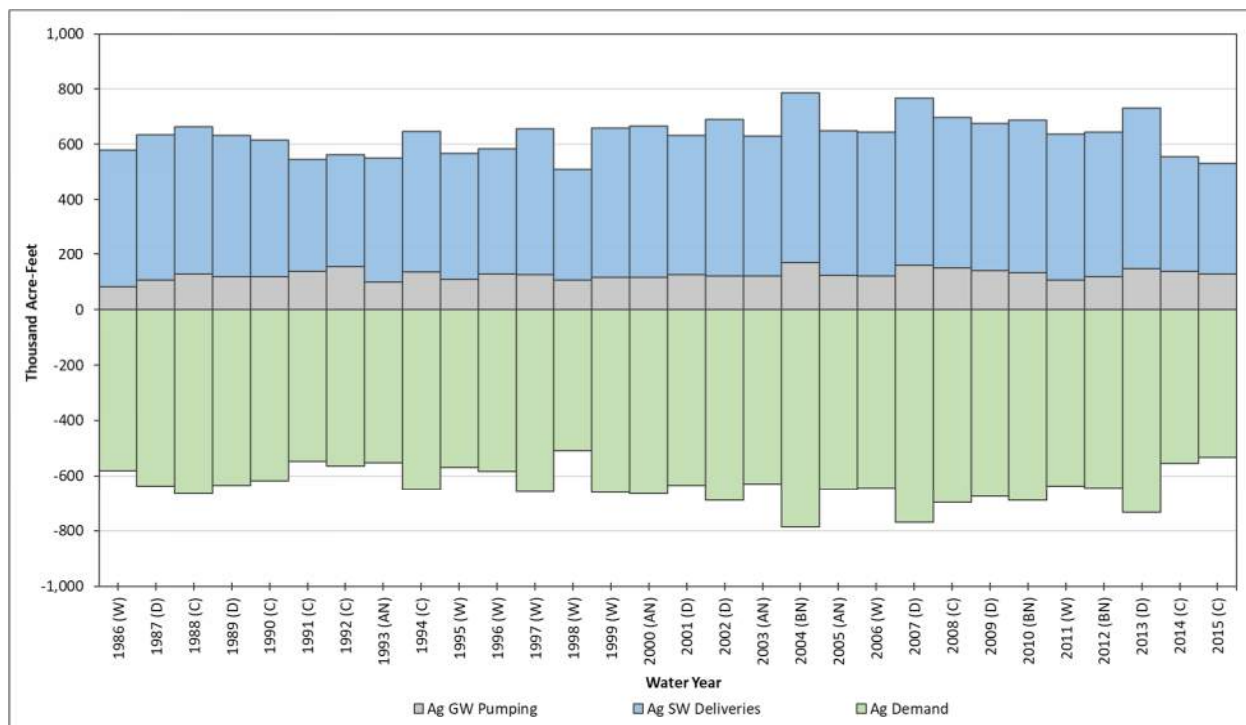

Figure 11: Sutter Subbasin Agricultural Land and Water Use Budget

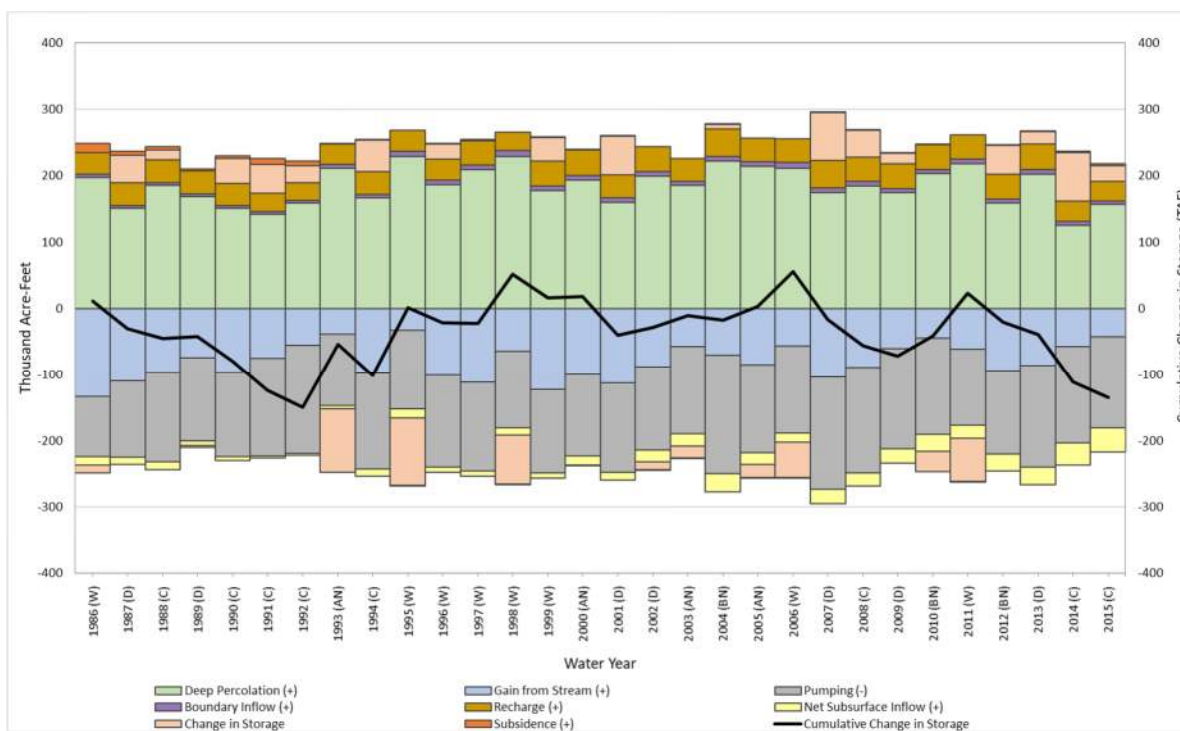

Figure 12: Sutter Subbasin Groundwater Budget

3.4 Streamflow Calibration

The major streams in the C2VSimFG-Sutter are Sacramento River, Feather River, and Sutter Bypass. Streamflow calibration is primarily performed by comparing the simulated streamflow at 5 locations with local data from stream gages (Table 5 and Figure 13). Data for these gages came from the United States Geological Survey (USGS) and California Data Exchange Center (CDEC). Simulated streamflow at additional stream gages in surrounding subbasins was also briefly compared to observed to verify the quality of the calibration on a regional scale.

Table 5: Summary of C2VSimFG-Sutter Streamflow Calibration Gages

Stream	Stream Node	Agency	Gage Name	Period of Record
Sacramento River	3502	USGS	USGS 11389500: Sacramento River at Colusa, CA	April 1921 to present
		CDEC	CDEC COL: Sacramento River at Colusa	January 1984 to present
Sacramento River	3554	USGS	USGS 11390500: Sacramento River Below Wilkins Slough Near Grimes, CA	October 1938 to present
		CDEC	CDEC WLK: Sacramento River Below Wilkins Slough	January 1984 to present
Sacramento River	4146	USGS	USGS 11425500: Sacramento River at Verona, CA	October 1929 to April 2021
		CDEC	CDEC VON: Sacramento River at Verona	January 1984 to present
Feather River	3974	USGS	USGS 11407150: Feather River Near Gridley, CA	October 1964 to September 1998
		CDEC	CDEC GRL: Feather River Near Gridley	January 1984 to present
Feather River	4061	USGS	USGS 11421700: Feather River Below Shanghai Bend Near Olivehurst, CA	October 1969 to September 1980
		CDEC	CDEC FSB: Feather River at Boyd's Landing Above Star Bend	November 2008 to present

Streamflow calibration included analysis of the streambed hydraulic conductivity, rating tables and stream geometry, and stream gain from or loss to the groundwater system. Simulated stream flows were compared with observed records and exceedance charts were also used to check the model performance when simulating high and low flows at each gage location. The locations of the above stream gages are shown in Figure 13. Calibration results for select stream gages in Figure 14 and Figure 15.

While Sacramento River simulated flows lined up closely with observed measurements throughout calibration, Feather River required more focused improvements. Streambed elevations, rating tables, and streambed hydraulic conductivity were imported from the Yuba Groundwater Model (YGM) for North and South Honcut Creek, Yuba River, Bear River, and Feather River. YGM is a well-calibrated local model used for planning in the North and South Yuba Subbasins. It is a highly localized model that provided a higher level of refinement for the area than C2VSimFG. These adjustments resulted in Feather River stream flows more closely matching observed groundwater levels along the Feather River.

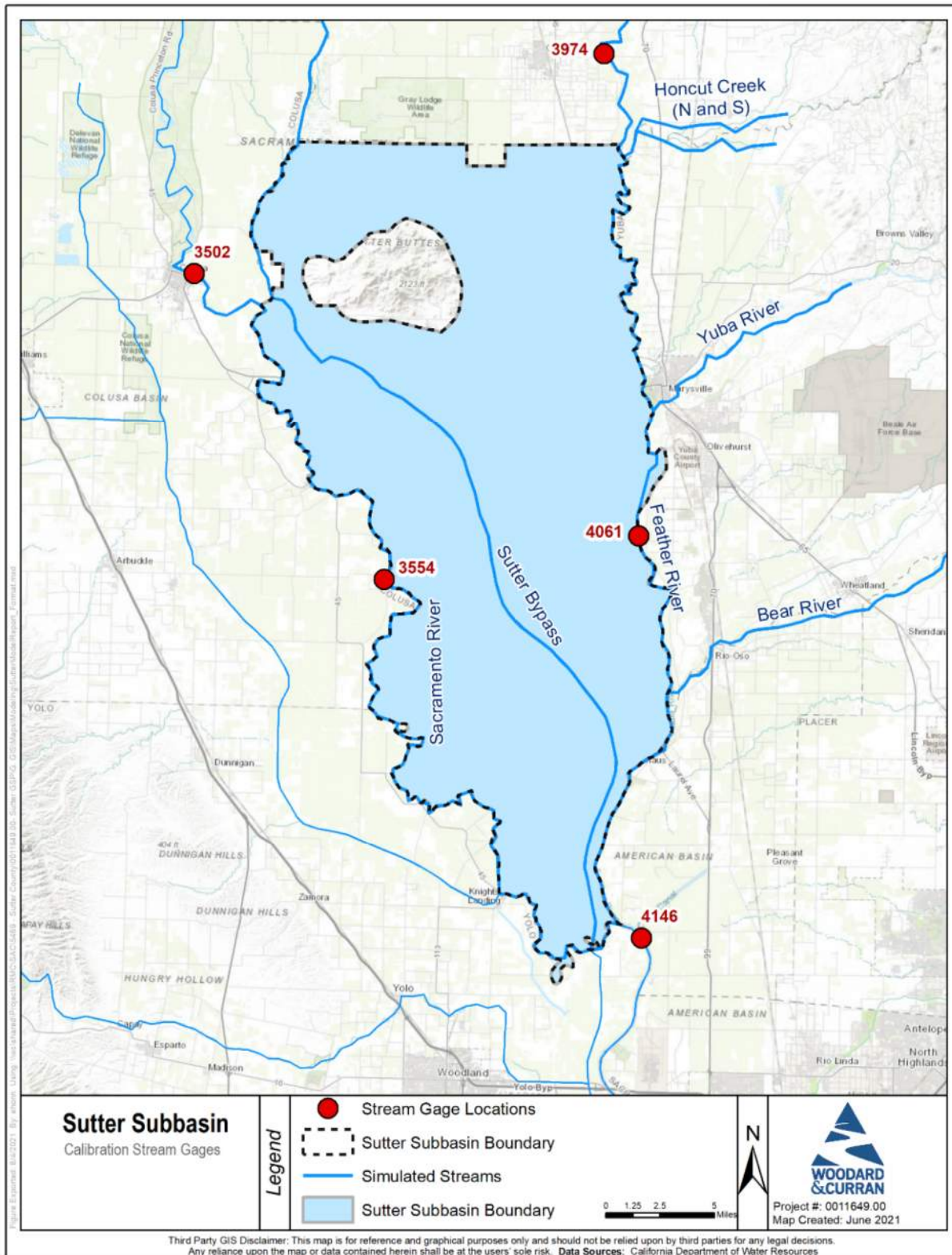

Figure 13: Stream Gage Locations with Stream Node ID Labeled

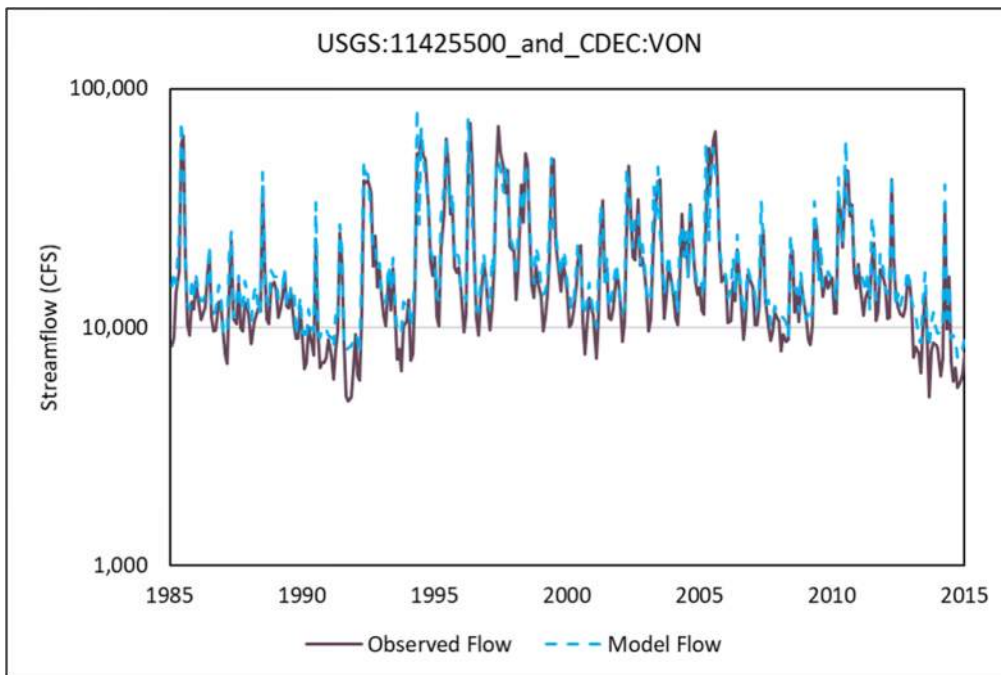

Figure 14: Sacramento River at Verona Simulated and Observed Stream Flows (Stream Node 4146)

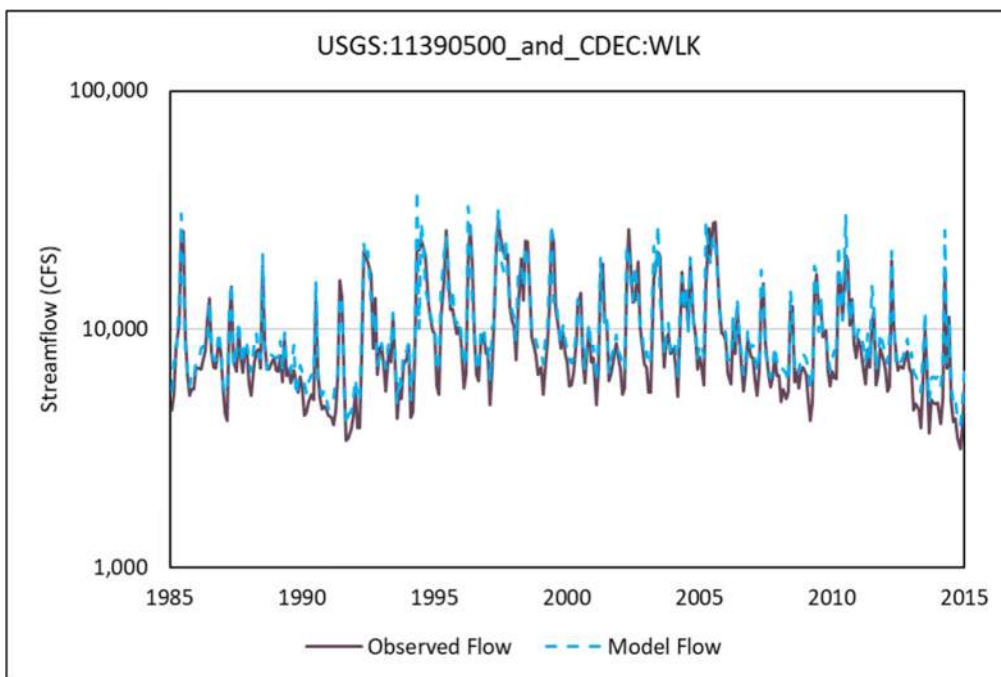

Figure 15: Sacramento River Below Wilkins Slough Simulated and Observed Stream Flows (Stream Node 3554)

3.5 Groundwater Level Calibration

Similar to streamflow calibration, the goal of groundwater level calibration is to achieve reasonable agreement between the simulated and observed groundwater levels at the selected groundwater calibration wells. Within Sutter Subbasin and a five-mile buffer around the Subbasin, 223 wells were evaluated for groundwater observation locations to track calibration at both a regional and local scale. These wells came from DWR's California Statewide Groundwater Elevation Monitoring (CASGEM) Program. The calibration wells were filtered based on their period of observation records, quality of observed data, number of measurements between 1990 and 2015, and spatial location. Among these wells were vetted calibration wells used in surrounding models, including Butte Basin Groundwater Model (BBGM), C2VSimFG-Colusa, Yuba Groundwater Model (YGM), Cosumnes-South American-North American (CoSANA) model, and C2VSimFG v1.0 calibration wells. Selected C2VSimFG-Sutter calibration well locations are shown in Figure 16.

Simulated groundwater levels were calibrated to observed groundwater levels through adjustments to model aquifer parameters including hydraulic conductivity, specific storage, and specific yield. The goal of groundwater level calibration is to achieve the maximum agreement between simulated and observed groundwater elevations at calibration wells while maintaining reasonable values for aquifer parameters. The groundwater level calibration was performed in two stages:

- The initial calibration effort was focused on the regional scale to verify hydrogeological assumptions made during model data development and confirm the accuracy of general groundwater flow directions. During this iteration, simulated groundwater elevation trends, flow directions, and groundwater gradients were compared to measured data.
- The second stage of calibration of groundwater levels was to analyze the simulated and observed groundwater levels by water supply type. The Subbasin includes large areas that are primarily served by groundwater and large areas that receive both surface water and groundwater. This comparison provides information on the overall model performance during the simulation period, focusing on the period of water years 1990 through 2015.

The results of the groundwater level calibration indicate that the C2VSimFG-Sutter reasonably simulates the long-term hydrologic responses under various hydrologic conditions in Sutter Subbasin. Figure 16 shows a selection of calibration wells with their resulting groundwater level hydrographs. Calibration statistics are provided in Figure 17 and Figure 18.

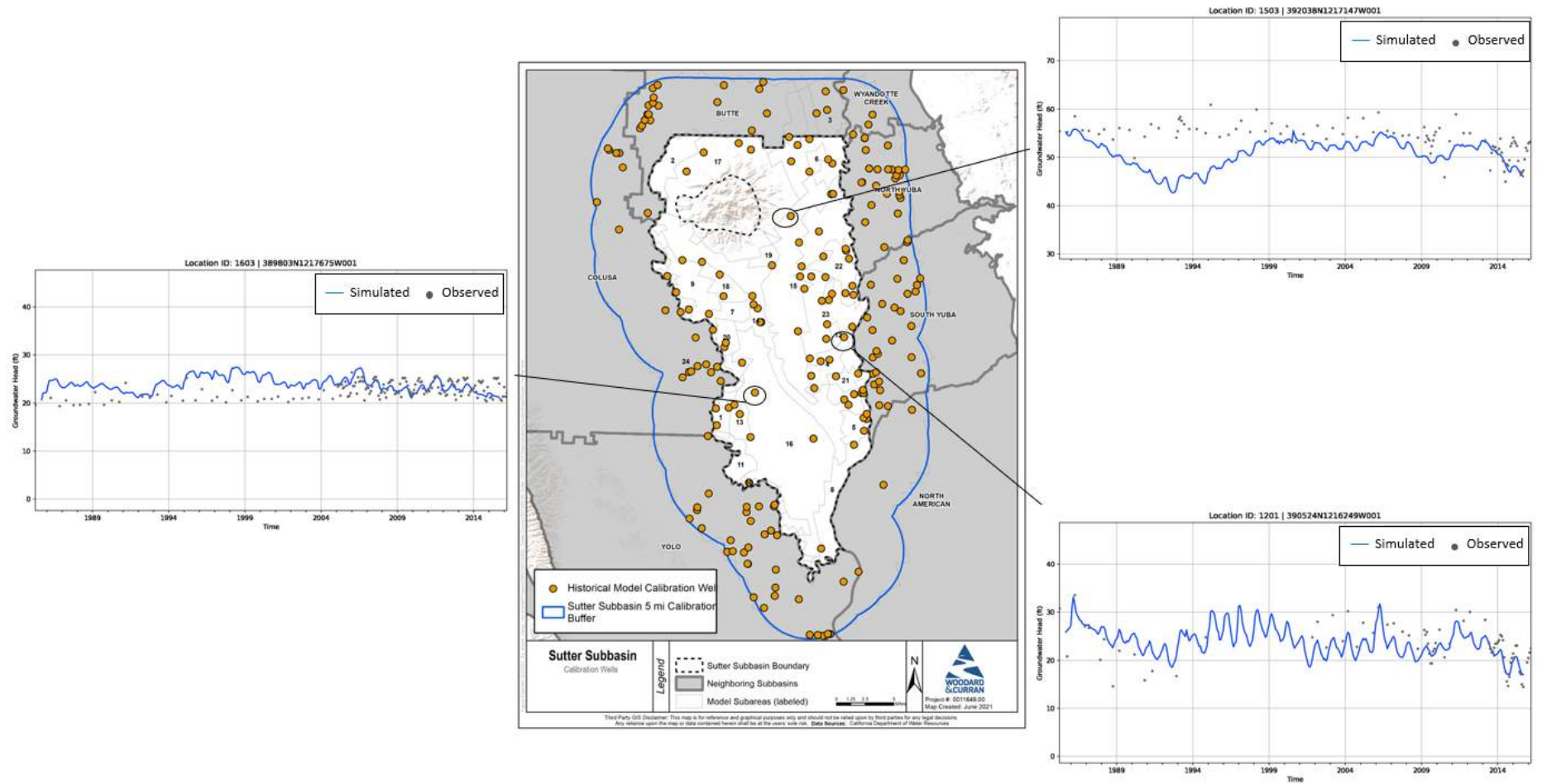

Figure 16: Hydrographs for Selected Calibration Wells

This page intentionally left blank.

3.5.1 Calibration Statistics

The C2VSim-Sutter simulated groundwater levels were evaluated to meet the American Standard Testing Method (ASTM) standards. The “Standard Guide for Calibrating a Groundwater Flow Model Application” (ASTM D5981) states that “the acceptable residual should be a small fraction of the head difference between the highest and lowest heads across the site.” The residual is defined as the simulated head minus the observed head. An analysis of all observed groundwater levels within the model area indicated the presence of approximately 200 feet of groundwater level changes in Sutter Subbasin. Assuming 10 percent as the small fraction, the acceptable residual level would be about 20 feet. Calibration goals for the groundwater level residuals were set such that no more than 10 percent of the observed groundwater levels would exceed the acceptable residual level of 20 feet.

- 83% of observed groundwater levels are within +/- 10 feet of its respective simulated values
- 98% of observed groundwater levels are within +/- 20 feet of its respective simulated values
- 99% of observed groundwater levels are within +/- 30 feet of its respective simulated values

The residual histogram for the monitoring wells selected to be part of the calibration dataset for C2VSimFG-Sutter is shown in Figure 17. Additionally, a scatter plot of simulated versus observed values is shown in Figure 18.

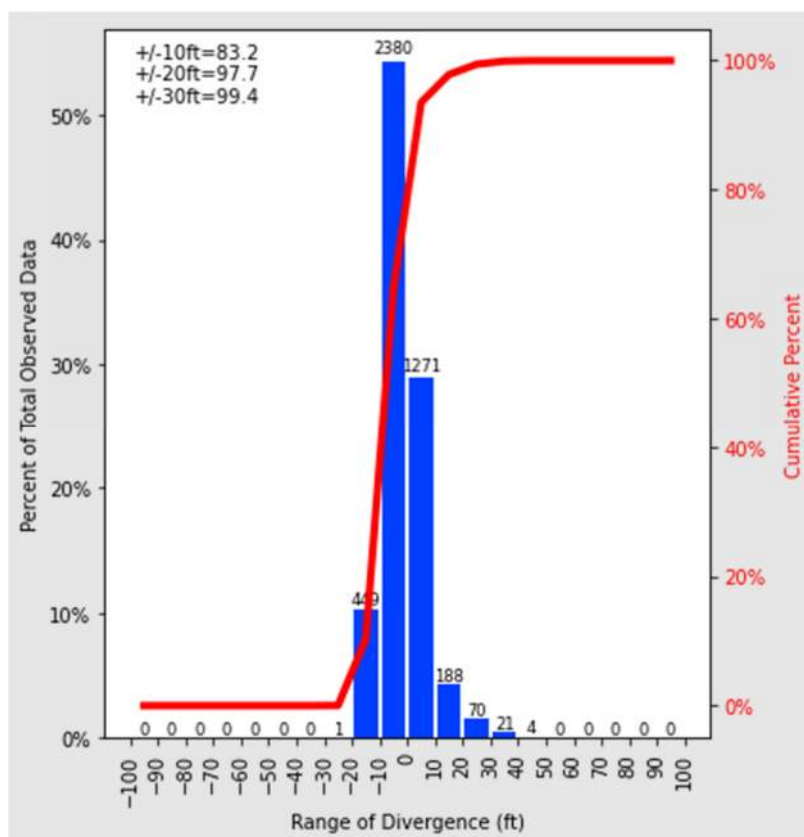

Figure 17: Residual Histogram of C2VSimFG-Sutter Observations within Sutter Subbasin

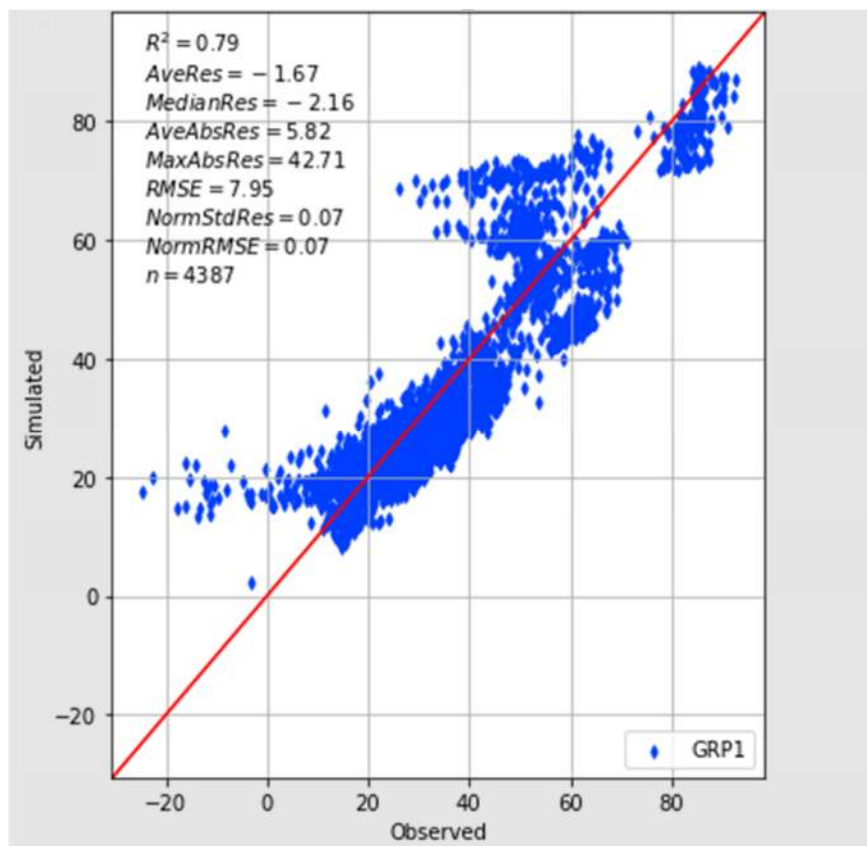

Figure 18: Scatter Plot of C2VSimFG-Sutter Observations within Sutter Subbasin

3.6 Sensitivity Analysis

Sensitivity analysis is an important step in the model development process. It is defined as “the study of distribution of dependent variables (e.g., groundwater elevations in a groundwater model) in response to changes in the distribution of independent variables, initial conditions, boundary conditions, and physical parameters” (AWWA, 2001). In general, a sensitivity analysis of an integrated groundwater and surface water model is performed for the following purposes:

- To test the robustness and stability of the model by establishing tolerance within which the model parameters can vary without significantly changing the model results;
- To understand the impact of inaccuracies in input data on model results (e.g., how model results can change because of a 10% error in the estimation of agricultural pumping); and
- To develop an understanding of the relative sensitivity of the components of the hydrologic cycle and data, so that an effective data collection and monitoring plan can be developed.

A sensitivity analysis was performed using the C2VSimFG-Sutter to assess the sensitivity of model results to specific model parameters. Adjustments to the following parameters were analyzed and evaluated using the resulting calibration well residuals.

- Aquifer Parameters
 - Horizontal Hydraulic Conductivity (Horizontal K)
 - Vertical Hydraulic Conductivity (Vertical K)
 - Specific storage
 - Specific yield
- Soil Parameters
 - Soil conductivity (for both non-ponded and ponded crops)
 - Lambda

The average of residuals between model simulated groundwater levels and observed groundwater levels was taken for all calibration wells within Sutter Subbasin for each sensitivity analysis run. The change in average residual for each sensitivity run due to the change in aquifer or soil parameter is shown. Analysis performed on aquifer parameters indicated that the model was fairly sensitive to changes in horizontal K, but less sensitive to changes in vertical K. There was a 1 ft increase and more than 2 ft decrease in the average residual across calibration wells in Sutter Subbasin when horizontal K in all layers was multiplied by 2 and divided by 2, respectively. In contrast, when vertical K was multiplied by the same factors, the average residual changed by less than 0.1 feet in both cases (Figure 19).

Specific storage and specific yield were found to not be sensitive to parameter changes in C2VSimFG-Sutter. The soil parameters of soil conductivity and lambda in C2VSimFG-Sutter were also found to have very little sensitivity to changes in relation to their base parameters (Figure 20).

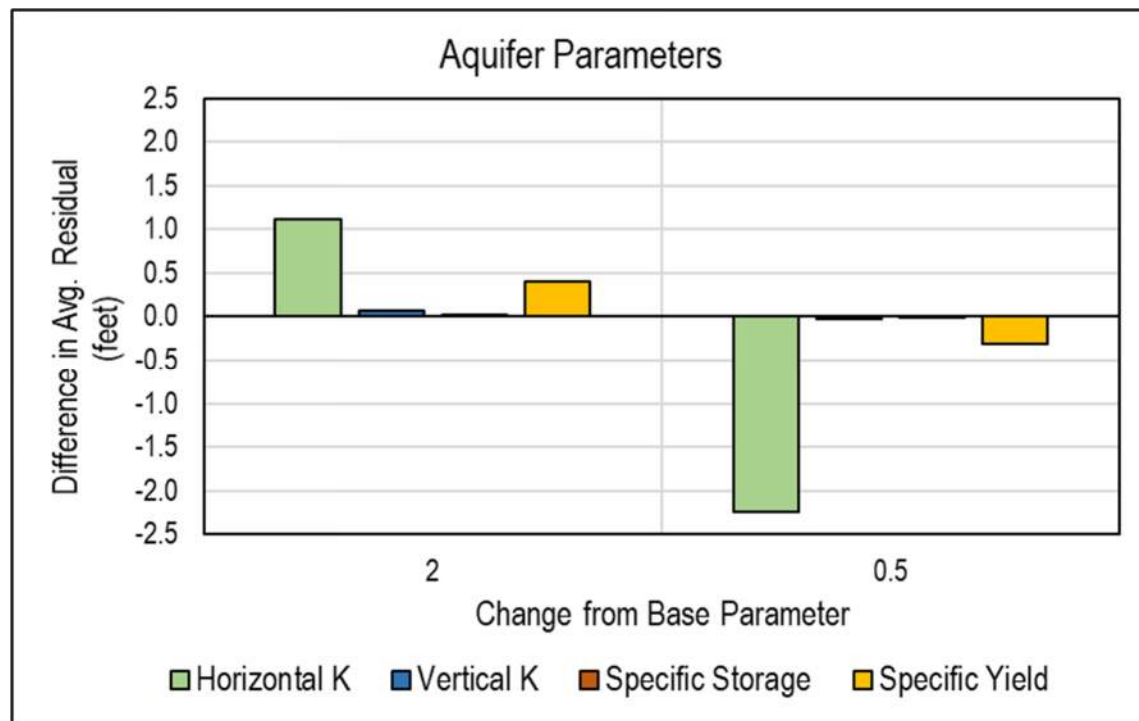

Figure 19: Relative Differences in Residuals with Changing Aquifer Parameter

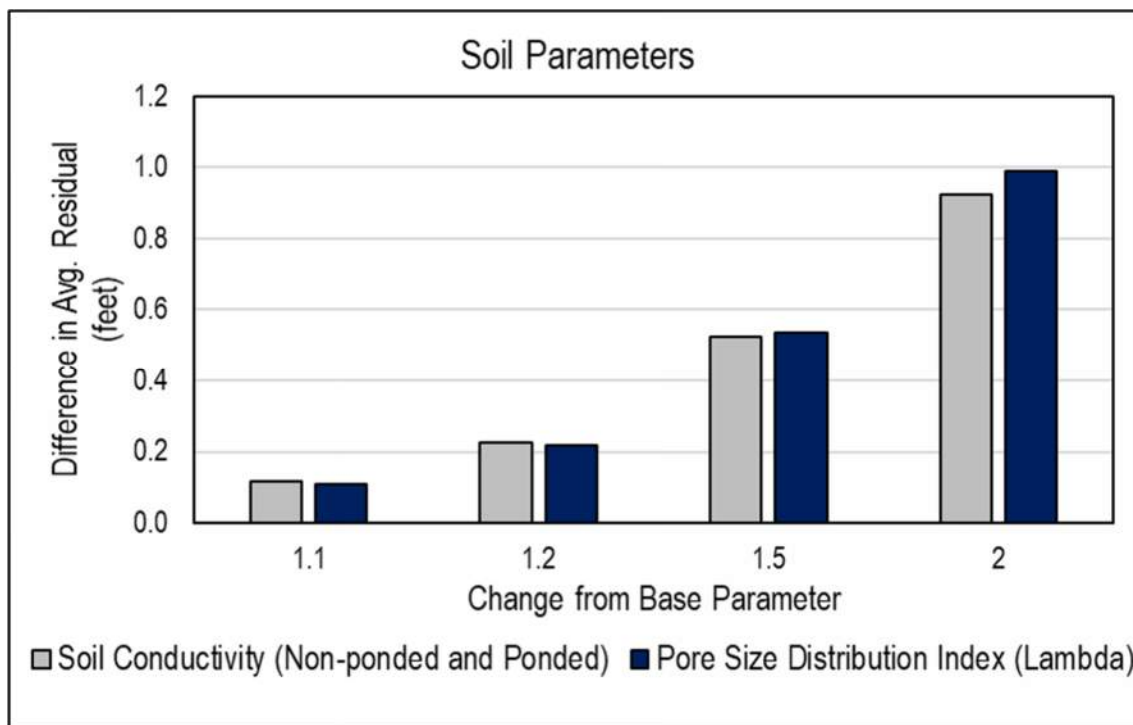

Figure 20: Relative Differences in Residuals with Changing Soil Parameters

4. FUTURE REFINEMENTS

The C2VSimFG-Sutter model is a well-calibrated regional integrated surface water and groundwater model that can be used effectively to analyze surface and groundwater conditions of the Sutter Subbasin.

C2VSimFG-Sutter model was developed based on DWR's C2VSimFG 1.0 model for the entire Central Valley of California for a simulation period ending in 2015. During development and calibration of C2VSimFG-Sutter model, several potential refinements were identified to may be included in future refinements to the model. These refinements may include:

- **Extension of time series data past WY 2015.** With the calibrated model, extending time series data (e.g., precipitation, land use, stream inflows, evapotranspiration, surface water diversions, urban demand, groundwater pumping) allows for use of more recent data and improved accuracy of the model for predicting near-term and future conditions in the Sutter groundwater subbasin.
- **Interbasin flows.** C2VSimFG-Sutter model groundwater levels show good calibration around the edges of the model. However, the streams bordering the Subbasin (Feather River and Sacramento River) tend to keep groundwater levels near the stream at a consistent level. Interbasin coordination with the surrounding groundwater subbasins as part of the GSP process can allow for sharing of information on stream-aquifer interaction on those shared streams as well as subsurface flows occurring between the subbasins.

5. REFERENCES

- AWWA. (2001). *Water Resources Planning. Manual of Water Supply Practices (M50) Second Edition*.
- Dogrul, E., Kadir, T., & Brush, C. (2021). *Integrated Water Flow Model Theoretical Documentation (IWF-2015), Revision 1129*. Retrieved from <https://water.ca.gov/Library/Modeling-and-Analysis/Modeling-Platforms/Integrated-Water-Flow-Model>
- DWR. (2021). *Chronological Reconstructed Sacramento and San Joaquin Valley Water Year Hydrologic Classifications Indices*. Retrieved from <https://cdec.water.ca.gov/reportapp/javareports?name=WSIHIST>
- SGMO. (2020). *California Central Valley Groundwater-Surface Water Simulation Model - Fine Grid (C2VSimFG) Development and Calibration Version 1.0*. California Department of Water Resources (DWR). Retrieved from <https://data.cnra.ca.gov/dataset/c2vsimfg-version-1-0/resource/4f904e97-a47b-4138-81df-9b74bd952948>
- Wood Rodgers. (2012). *Sutter County Groundwater Management Plan*. Retrieved from https://www.suttercounty.org/contents/pdf/pw/wr/gmp/Sutter_County_Final_GMP

This page intentionally left blank.



woodardcurran.com
COMMITMENT & INTEGRITY DRIVE RESULTS

Appendix 5-H
Projected Water Budget Climate Change Methodology

This page intentionally left blank.



**PROJECTED
WATER BUDGET
CLIMATE
CHANGE
METHODOLOGY**

Sutter Subbasin
Groundwater
Sustainability Plan

801 T Street
Sacramento, CA 95811
800.426.4262

woodardcurran.com
COMMITMENT & INTEGRITY DRIVE RESULTS

0011649.00
Sutter County
August 2021

TABLE OF CONTENTS

SECTION	PAGE NO.
EXECUTIVE SUMMARY	ES-1
1. CLIMATE CHANGE ANALYSIS.....	1-1
1.1 Regulatory Background	1-1
1.2 DWR Guidance and Climate Change Methodology	1-1
1.2.1 Streamflow under Climate Change	1-3
1.2.2 Precipitation and Evapotranspiration under Climate Change	1-8
1.2.2.1 Applying Change Factors to Precipitation	1-8
1.2.2.2 Applying Change Factors to Evapotranspiration	1-10
2. REFERENCES.....	2-12

TABLES

Table 1: DWR-Provided Datasets used in Sutter Subbasin GSP

Table 2: Sacramento Valley Water Year Type Designations

FIGURES

Figure 1: Sutter Subbasin Climate Change Analysis Process

Figure 2: C2VSimFG Sacramento River Inflow Hydrograph

Figure 3: C2VSimFG Sacramento River Inflow Exceedance Curve

Figure 4: C2VSimFG Feather River Inflow Hydrograph

Figure 5: C2VSimFG Feather River Inflow Exceedance Curve

Figure 6: Average Annual Total Precipitation Under Climate Change

Figure 7: Average Annual Total Precipitation Under Climate Change Exceedance Curve

Figure 8: Average Monthly Evapotranspiration for Select Crops Under Climate Change

1. CLIMATE CHANGE ANALYSIS

1.1 Regulatory Background

The Sustainable Groundwater Management Act (SGMA) requires the development of Groundwater Sustainability Plans (GSPs) that provide a pathway towards, and ensures the long-term management of, sustainable groundwater basins. In preparing these plans, the GSP Emergency Regulations require consideration of uncertainties associated with climate change. Consistent with Section 354.18(d)(3) and Section 354.18(e) of the GSP Emergency Regulations, an analysis was performed for the Sutter Subbasin evaluating the projected (future) water budget with and without climate change conditions.

Section 354.18(d)(3) of the GSP Emergency Regulations states:

“(d) The Agency shall utilize the following information provided, as available, by the Department pursuant to Section 353.2, or other data of comparable quality, to develop the water budget:

- (1) Historical water budget information for mean annual temperature, mean annual precipitation, water year type, and land use.*
- (2) Current water budget information for temperature, water year type, evapotranspiration, and land use.*
- (3) Projected water budget information for population, population growth, **climate change** [emphasis added], and sea level rise.”*

Section 354.18(e) states:

*“(e) Each Plan shall rely on the best available information and best available science to quantify the water budget for the basin in order to provide an understanding of historical and projected hydrology, water demand, water supply, land use, population, **climate change** [emphasis added], sea level rise, groundwater and surface water interaction, and subsurface groundwater flow. If a numerical groundwater and surface water model is not used to quantify and evaluate the projected water budget conditions and the potential impacts to beneficial uses and users of groundwater, the Plan shall identify and describe an equally effective method, tool, or analytical model to evaluate projected water budget conditions.”*

1.2 DWR Guidance and Climate Change Methodology

Climate change analysis is an area of continued evolution in terms of methods, tools, forecasted datasets, and the predictions of greenhouse gas concentrations in the atmosphere. The approach developed for the Sutter Subbasin GSP is based on the methodology in the California Department of Water Resources’ (DWR’s) guidance document *Guidance for Climate Change Data Use During Groundwater Sustainability Plan Development* (DWR, 2018a). The “best available information” related to climate change in the Sutter Subbasin was deemed to be the information provided by DWR combined with basin-specific modeling tools. The following resources from DWR were used in the climate change analysis:

- SGMA Data Viewer
- *Guidance for Climate Change Data Use During Sustainability Plan Development* and Appendices (Guidance Document)
- Water Budget Best Management Practices (BMP)

The SGMA Data Viewer contains climate change forecast datasets for download and use in GSP development (DWR, 2018b). The guidance document details the approach, development, applications, and limitations of the datasets available from the SGMA Data Viewer (DWR, 2018b). The Water Budget BMP, entitled *Handbook for Water*

Development With or Without Models, describes in greater detail how DWR recommends projected water budgets with climate change be estimated (DWR, 2016).

The methods suggested by DWR in the above resources were used, with modifications where needed, to ensure the results would be reasonable for the Sutter Subbasin and align with the assumptions of the C2VSimFG-Sutter. **Error! Reference source not found.** shows the overall process developed and adapted for the Subbasin consistent with the climate change resource guidance (DWR, 2018a) and describes workflow beginning with projected conditions inputs and assumptions to perturbed 2070 conditions for the projected conditions.

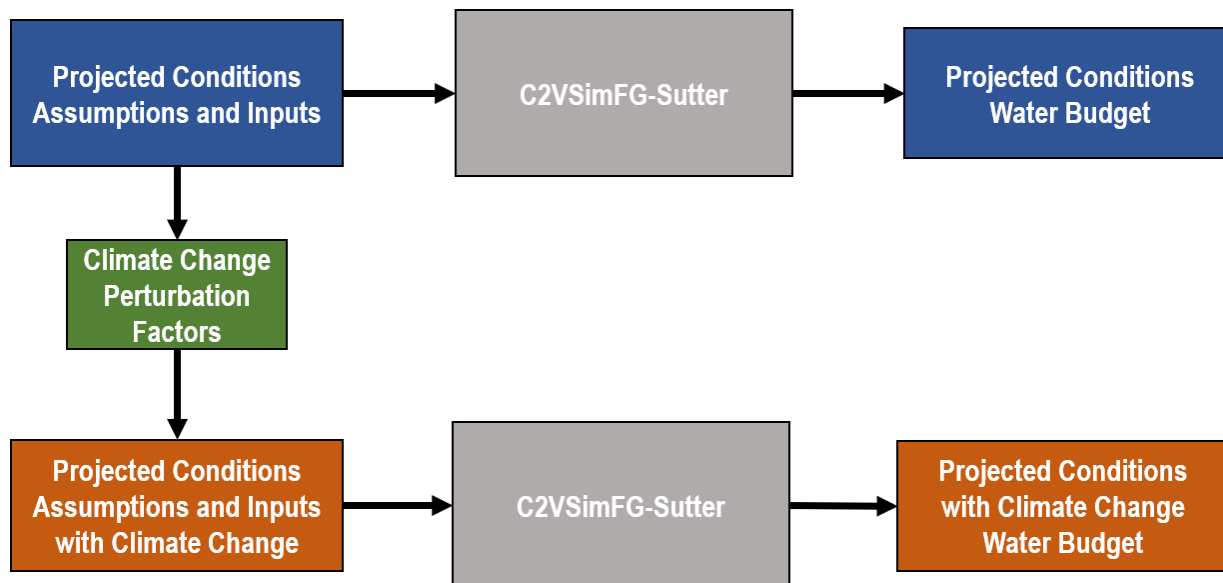

Figure 1: Sutter Subbasin Climate Change Analysis Process

The process described in Figure 1 enables the analysis to account for variability in demand and supply separate from the uncertainty associated with climate change forecasts. Table 1 summarizes the forecasted variable datasets provided by DWR that were used to carry out the climate change analysis (DWR, 2018a). The Variable Infiltration Capacity (VIC) model referred to in Table 1 is the fully mechanistic hydrologic model used by DWR to derive precipitation and evapotranspiration time series with and without and climate change conditions.

Table 1: DWR-Provided Datasets used in Sutter Subbasin GSP

Input Variable	DWR-Provided Dataset
Unimpaired Streamflow	Combined VIC model runoff and baseflow to generate change factors, provided by HUC 8 watershed geometry
Precipitation	VIC model-generated GIS grid with associated change factor time series for each cell
Reference ETo	VIC model-generated GIS grid with associated change factor time series for each cell

The following four climate change scenarios were provided by DWR:

- **2030 Central Tendency**: Ensemble of 10 global climate models (GCMs) recommended by the Climate Change Technical Advisory Group (CCTAG) to best represent California, run for both RCP¹ 4.5 (moderate level of climate change mitigation) and 8.5 (business as usual), representing near future conditions.
- **2070 Central Tendency**: Ensemble of 10 GCMs recommended by the CCTAG to best represent California, run for both RCP 4.5 and 8.5, representing late future conditions.
- **2070 Dry, Extreme Warming**: Extreme scenario with a single GCM (HadGEM2-ES) with RCP 8.5.
- **2070 Wet, Moderate Warming**: Extreme scenario with a single GCM (CNRM-CM5) with RCP 4.5.

Given water budget analyses and groundwater levels do not indicate widespread, long-term decline, the 2070 central tendency scenario (2070 CT) was chosen to estimate Sutter Subbasin's climate change projected conditions. This scenario was chosen for its useful long-term planning horizon (~50 years) and moderate climate change impact estimations. Accepted methods for estimating climate change impacts on groundwater are based on the assessment of impacts on the individual water resource system elements that directly link to groundwater. These elements include precipitation, streamflow, evapotranspiration and, for coastal aquifers, sea level rise as a boundary condition. For the Sutter Subbasin, sea level rise was not included as it does not apply.

As a cross-check, the 2070 dry, extreme warming scenario (2070 DEW) was also run and compared against the results utilizing the 2070 central tendency scenario (2070 CT) in order to evaluate a 'worst-case' scenario. The same methodology as the 2070 CT scenario, described in the following sections, was used for perturbing the streamflow, precipitation, and evapotranspiration input files for the 2070 DEW scenario. A comparison of these results, projected water budget with 2070 CT vs. 2070 DEW, is presented in each section.

1.2.1 Streamflow under Climate Change

Hydrologic forecasts for streamflow under various climate change scenarios are available from DWR as either a flow-based timeseries or a series of perturbation factors applicable to local data. DWR simulates volumetric flow in most regional surface water bodies by utilizing the Water Resource Integrated Modeling System (WRIMS, formally named CalSim II). Local tributaries and smaller streams within the Central Valley are simulated using adjustment factors developed by DWR for unregulated stream systems. The resolution of these perturbation factors is at the Hydrologic Unit Code 8 watershed scale.

With no reservoir operations directly contributing flows to Sutter Subbasin, DWR's watershed-based perturbation factors were used to simulate the impact of climate change on stream inflows to the model's calibration area. Streamflow contributions from runoff from the Sutter Buttes use the Integrated Water Flow Model (IWFM) small watershed package, whose climate change impacts are calculated internally based on changes due to climate change to precipitation and evapotranspiration inputs to the C2VSimFG-Sutter model.

¹ Representative Concentration Pathways (RCP) are "scenarios that include time series of emissions and concentrations of the full suite of greenhouse gases (GHGs) and aerosols and chemically active gases, as well as land use/land cover...The word representative signifies that each RCP provides only one of many possible scenarios that would lead to the specific radiative forcing characteristics. The term pathway emphasizes that not only the long-term concentration levels are of interest, but also the trajectory taken over time to reach that outcome" (IPCC, 2018).

Change factors were downloaded from SGMA Data Viewer for both the 2070 CT and the 2070 DEW scenarios. The projected conditions baseline input streamflow data was multiplied by the change factors to calculate perturbed flows. Water Year (WY) types are designated for each year based on the Sacramento Valley Runoff WY year type index (DWR, 2021). DWR uses five designations ranging from driest to wettest conditions: Critical, Dry, Below Normal, Above Normal, and Wet. Table 2 below shows the year type designations used to synthesize the remaining years (2011-2015).

DWR change factors are available through 2011; however, the model hydrologic period runs from Water Year 1986-2015. Flows for the remaining model years beyond 2011 were synthesized using the average change factor from all previous matching water year types available dataset.

Table 2: Sacramento Valley Water Year Type Designations

Water Year	Year Type
2011	Wet
2012	Below Normal
2013	Dry
2014	Critical
2015	Critical

Figure 2 shows the perturbed streamflow for the 2070 CT and DEW scenarios against the projected conditions baseline time series for the C2VSimFG Sacramento River inflow stream node approximately 100 miles north of Sutter Subbasin. Figure 3 presents the corresponding exceedance probability curve. The exceedance curve more clearly shows the differences between the projected conditions scenario and the climate change scenarios. Streamflow under the 2070 CT climate change scenario (light pink curve) is lower than the projected conditions baseline (dashed line) at intermediate to higher flows. At lower flows (below approximately 300 cubic feet/month), the 2070 CT and baseline scenarios have comparable flows. However, under the more extreme climate scenario (2070 DEW) (dark orange curve), all flows are expected to be lower than the no-climate change scenario. The exceedance curve shows that extreme peak events (the far-right side of the plot), however, may be minimally impacted by climate change in the Sacramento River.

Figure 4 and Figure 5 show a similar hydrograph and exceedance curve, but for a C2VSimFG Feather River inflow stream node approximately 25 miles north of Sutter Subbasin. On the Feather River, the hydrograph shows that low flows may not be as low under climate change in some years. However, the exceedance curve shows minimal impact of the 2070 CT scenario based on the change factors provided by DWR and only slightly lower flows overall in the extreme climate scenario.

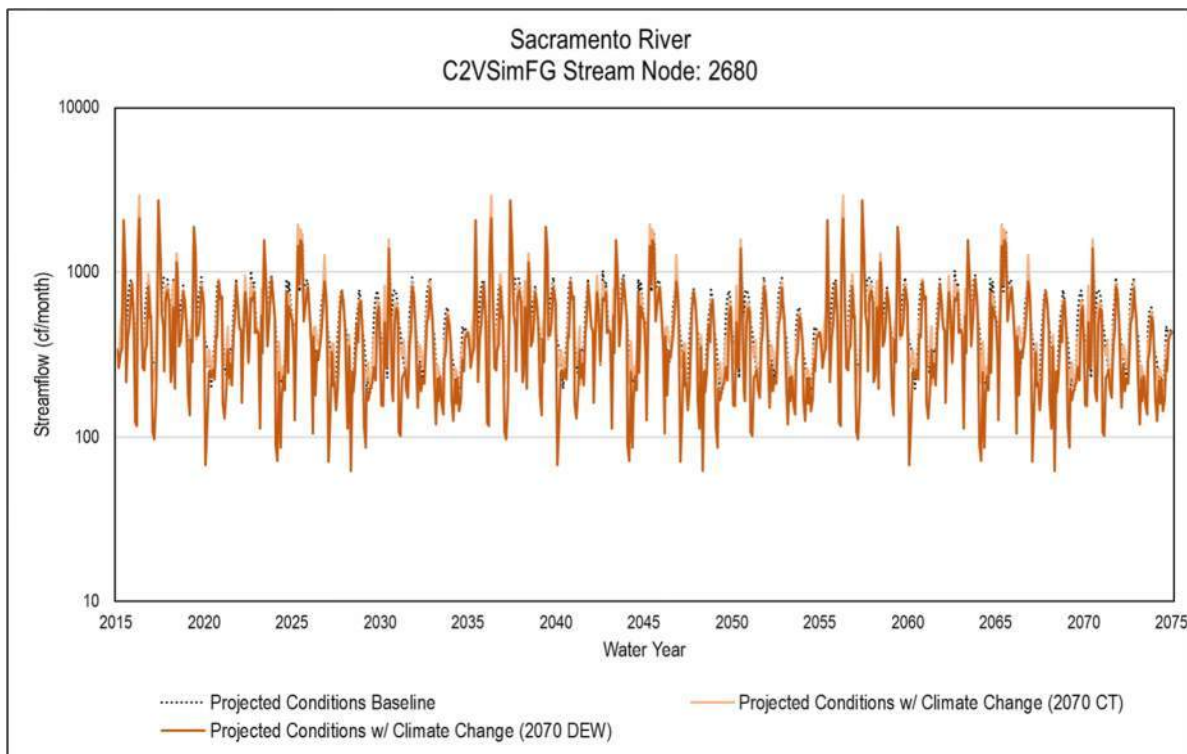

Figure 2: C2VSimFG Sacramento River Inflow Hydrograph

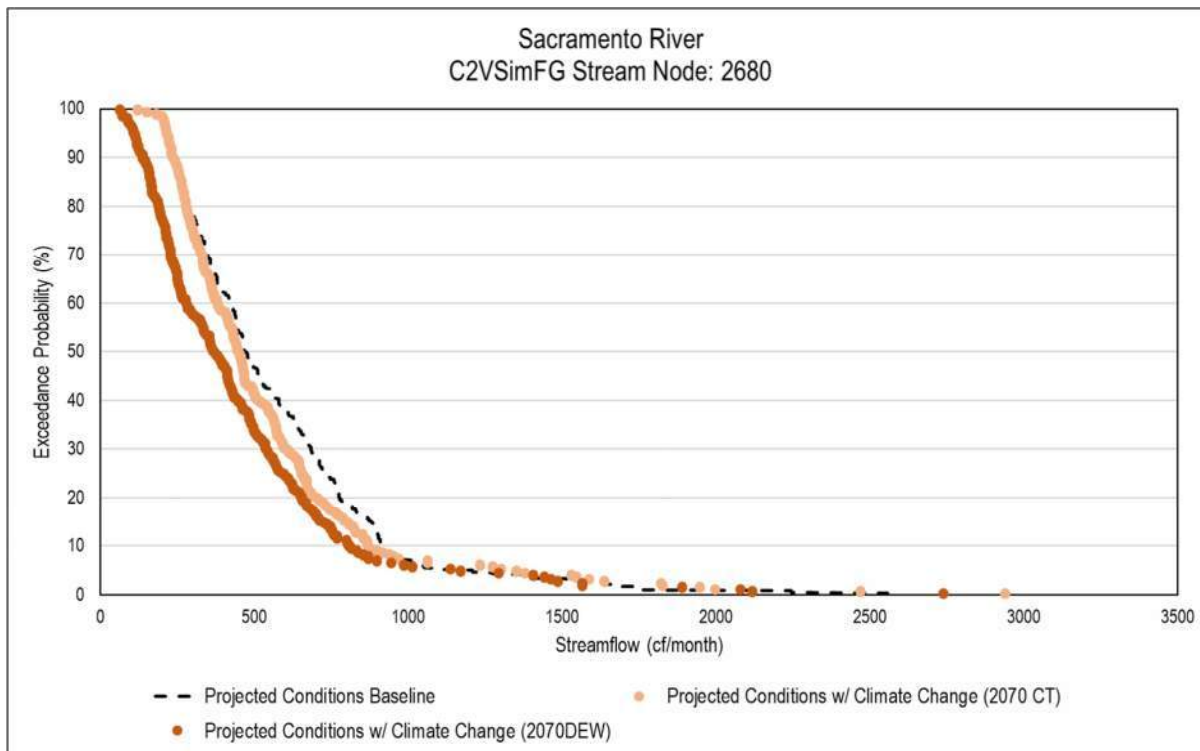

Figure 3: C2VSimFG Sacramento River Inflow Exceedance Curve

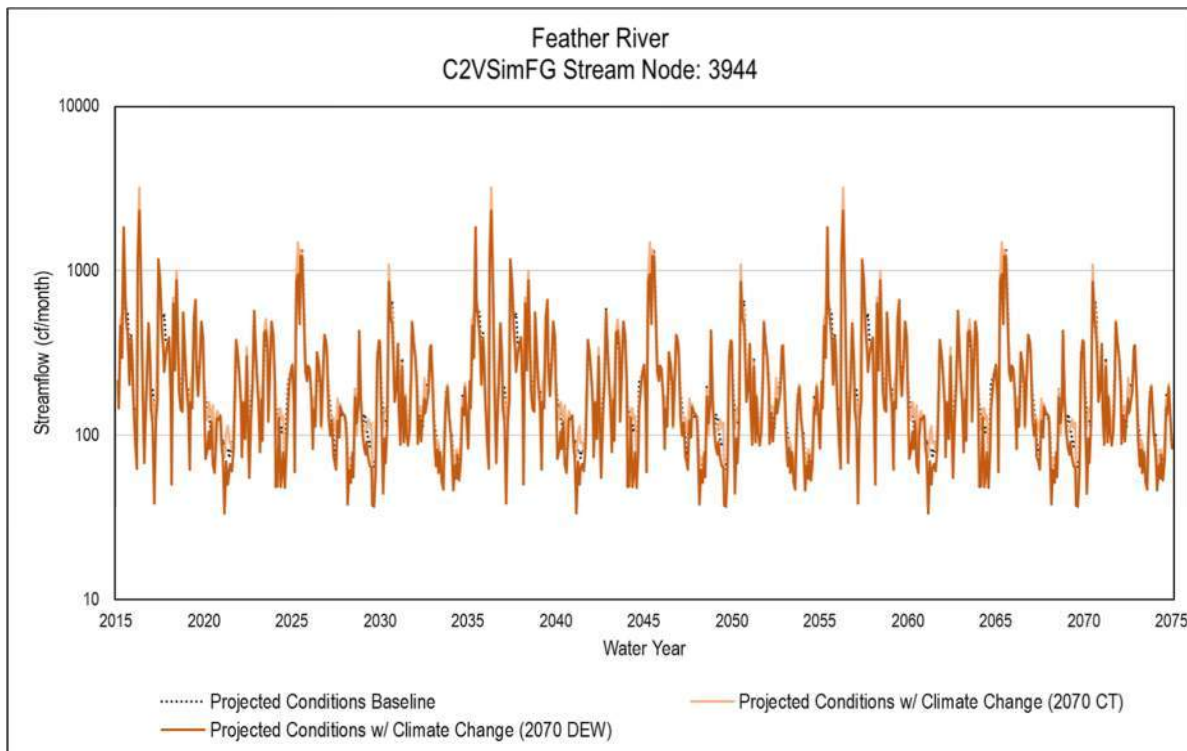

Figure 4: C2VSimFG Feather River Inflow Hydrograph

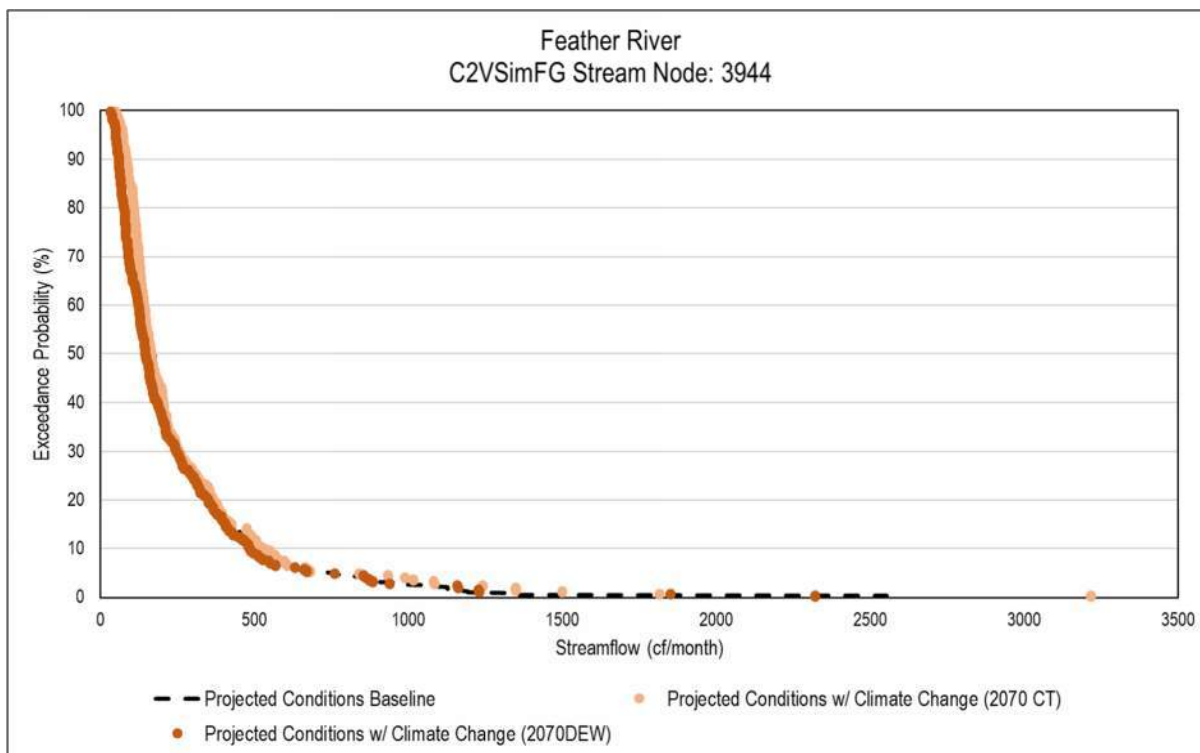

Figure 5: C2VSimFG Feather River Inflow Exceedance Curve

1.2.2 Precipitation and Evapotranspiration under Climate Change

Projected precipitation and evapotranspiration (ET_o) change factors were calculated by DWR using climate period analysis based on historical precipitation and ET_o from January 1915 to December 2011 (DWR, 2018a). DWR used a macroscale hydrologic model that solves the water balance of a watershed, called the VIC model. Change factors provided by DWR were calculated as a ratio of the value of a variable under a “future scenario” divided by a baseline. That baseline data are the 1995 Historical Temperature Detrended scenario downscaled from GCM climate data. The “future scenario” corresponds to VIC outputs of the simulation of future conditions using GCM forecasted hydroclimatic variables as inputs. These change factors are thus a simple perturbation factor that corresponds to the ratio of a future with climate change divided by the past without it. Change factors are available on a monthly time step and are spatially defined by the VIC model grid. Tables with the time series of perturbation factors are available from DWR for each grid cell.

1.2.2.1 Applying Change Factors to Precipitation

DWR change factors were multiplied by historical precipitation to generate projected precipitation under the 2070 central tendency scenario. Precipitation values were perturbed by change factors based on where they were spatially located within the VIC model grid. Small watershed precipitation time series were also perturbed based on which VIC grid fell at the centroid of the small watershed polygon.

Like for streamflow, DWR only includes change factors through 2011. The remaining four years of the time series (WY 2011-2015) were synthesized according to historically comparable water years. The comparable years that were used are presented in Table 2. The resulting perturbed precipitation values for both climate change scenarios and the

baseline precipitation values for the projected conditions without climate change are shown in Figure 6. Darker blue columns represent the 2070 DEW and lighter blue columns represent the 2070 CT, while the projected conditions without climate change are gray columns. In most years of the simulation period, total precipitation is expected to be slightly higher annually overall in the 2070 CT scenario. The extreme climate scenario simulates a future with less total precipitation overall in comparison to the baseline for dry and typical years. For very wet years under the 2070 DEW scenario, the years with peak precipitation in Sutter Subbasin is expected to be comparable than they would have been without the impact of climate change. The exceedance plot for these two times series is shown in Figure 7.

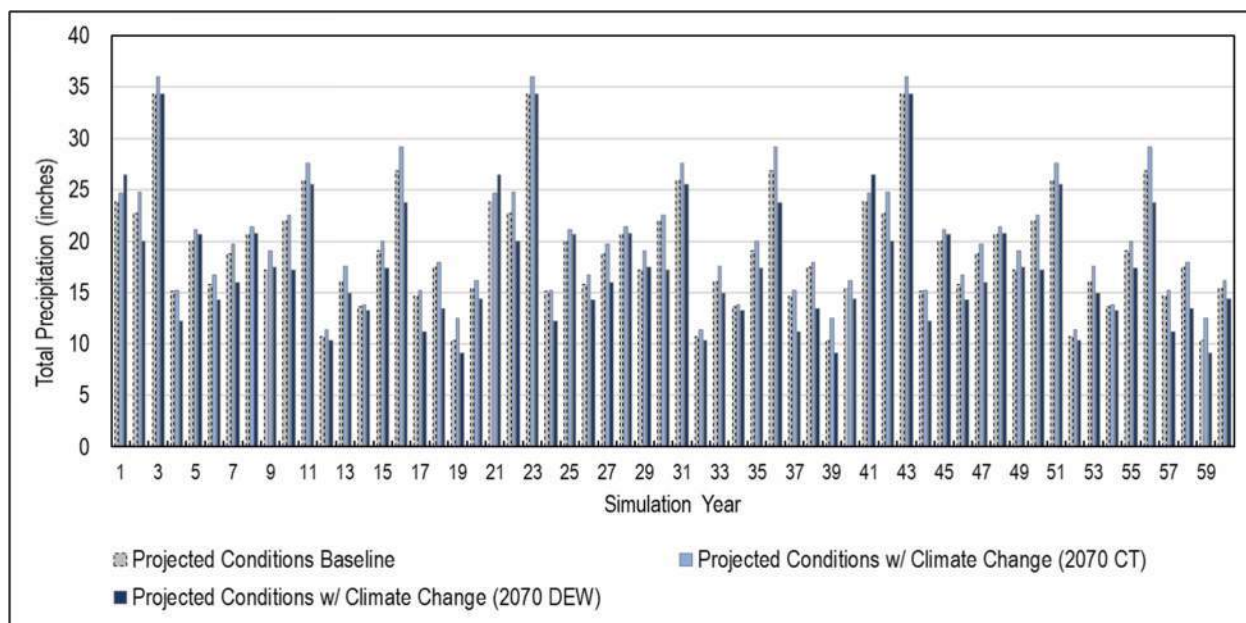

Figure 6: Average Annual Total Precipitation Under Climate Change

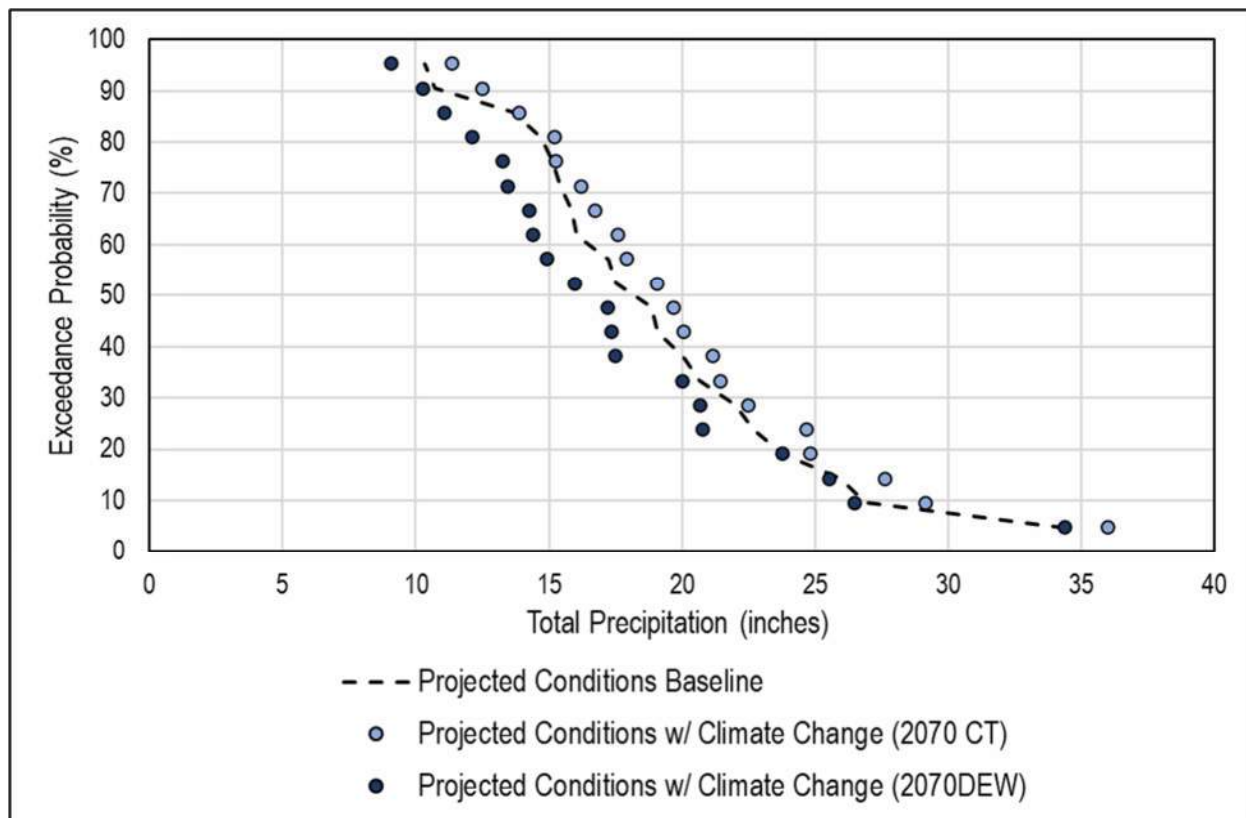

Figure 7: Average Annual Total Precipitation Under Climate Change Exceedance Curve

1.2.2.2 Applying Change Factors to Evapotranspiration

Potential ETo in the Subbasin varies geographically and by land use. DWR provides change factors for ETo that vary spatially based on the VIC model grid as described above. Perturbation of the projected conditions baseline was carried out at the subarea scale, a group of 23 zones determined based on water district and urban boundaries as well as water supply source used. These subareas are described in further detail in the model report (Appendix 5-G of the Sutter Subbasin GSP). All VIC grid ET change factor time series that overlapped each subarea were averaged to obtain one change factor time series for each climate change scenario for each subarea for each water year type. ETo values in all of the Sacramento Valley (C2VSim subregions 1-7) were perturbed. It is assumed that all crops will experience the same degree of impact of climate change and, therefore in this analysis, all crop ETs are perturbed using the same set of change factors. This is an assumption of this analysis that can be refined in future updates to this GSP based on local agricultural operations and observed climate change impact.

Figure 8 shows a sample of the results for select crops under the projected conditions baseline and under the projected conditions scenarios with climate change. Evapotranspiration, in inches, is plotted showing average monthly values across the simulation period for both the 2070 CT and 2070 DEW scenarios color-coded by crop. In Sutter Subbasin, evapotranspiration is expected to increase under both the moderate and extreme climate change scenarios, especially in the warmer months when evapotranspiration is already high. Scenario modeling results show the largest increases in evapotranspiration in June under both climate scenarios, but little change during winter months when evapotranspiration is typically at its lowest.

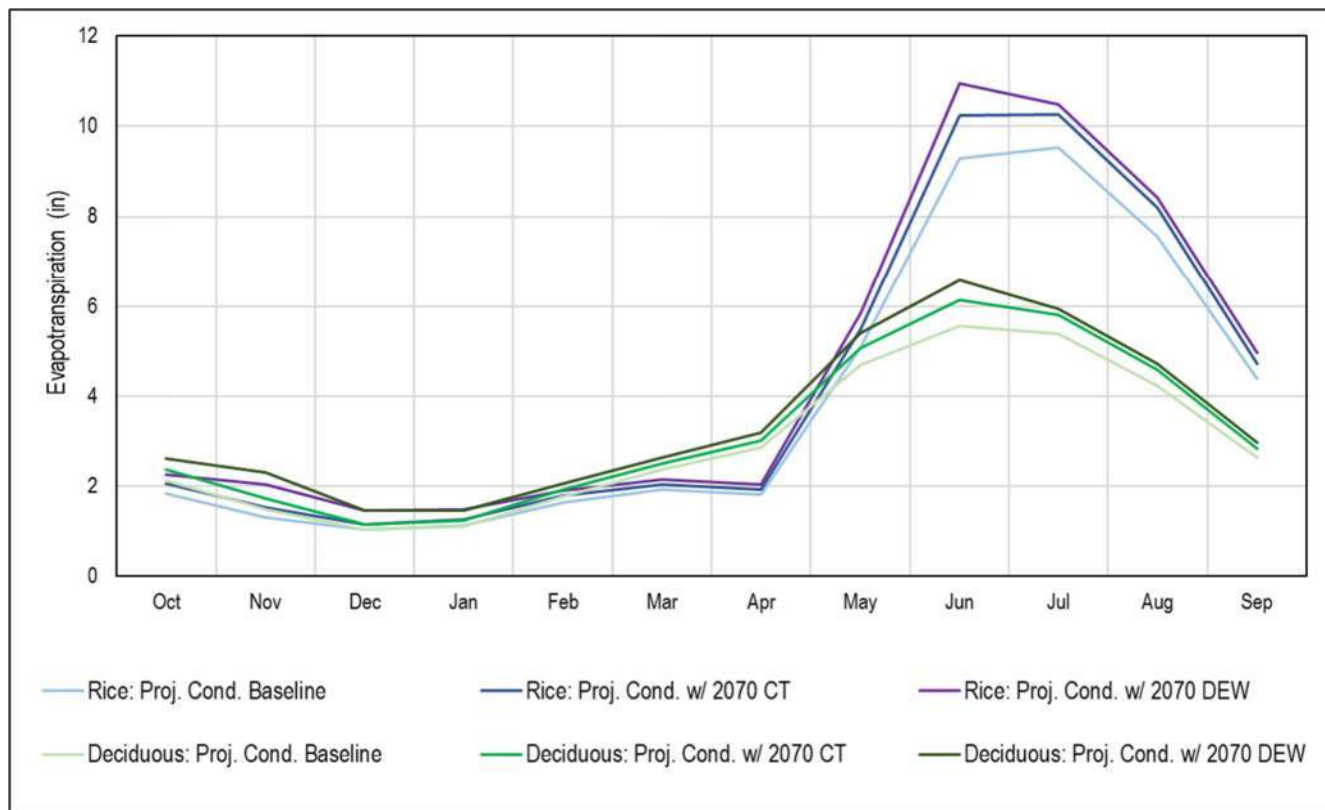

Figure 8: Average Monthly Evapotranspiration for Select Crops Under Climate Change

2. REFERENCES

- California Department of Water Resources (DWR). 2016. *Best Management Practices for the Sustainable Management of Groundwater: Water Budget*. https://water.ca.gov/-/media/DWR-Website/Web-Pages/Programs/Groundwater-Management/Sustainable-Groundwater-Management/Best-Management-Practices-and-Guidance-Documents/Files/BMP-4-Water-Budget_ay_19.pdf. Accessed: August 23, 2021.
- California Department of Water Resources (DWR). 2018a. *Guidance for Climate Change Data Use During Groundwater Sustainability Plan Development*. https://groundwaterexchange.org/wp-content/uploads/2020/09/Climate-Change-Guidance_Final_ay_19.pdf. Accessed: August 23, 2021.
- California Department of Water Resources (DWR). 2018b. *SGMA Data Viewer*. <https://sgma.water.ca.gov/webgis/?appid=SGMADataViewer#currentconditions>. Accessed: August 23, 2021.
- California Department of Water Resources (DWR). 201. Chronological Reconstructed Sacramento and San Joaquin Valley Water Year Hydrologic Classification Indices. <https://cdec.water.ca.gov/reportapp/javareports?name=WSIHIST>. Accessed: August 23, 2021.
- Intergovernmental Panel on Climate Change (IPCC). 2018. Annex I: Glossary [Matthews, J.B.R. (ed.)]. In: *Global Warming of 1.5°C. An IPCC Special Report on the impacts of global warming of 1.5°C above pre-industrial levels and related global greenhouse gas emission pathways, in the context of strengthening the global response to the threat of climate change, sustainable development, and efforts to eradicate poverty* [Masson-Delmotte, V., P. Zhai, H.-O. Pörtner, D. Roberts, J. Skea, P.R. Shukla, A. Pirani, W. Moufouma-Okia, C. Péan, R. Pidcock, S. Connors, J.B.R. Matthews, Y. Chen, X. Zhou, M.I. Gomis, E. Lonnoy, T. Maycock, M. Tignor, and T. Waterfield (eds.)]. In Press



woodardcurran.com
COMMITMENT & INTEGRITY DRIVE RESULTS

This page intentionally left blank.

Appendix 6-A
Hydrographs with Numeric SMCs for Chronic Lowering of
Groundwater Levels and Depletions of Interconnected
Surface Water Representative Monitoring Sites

This page intentionally left blank.

Chronic Lowering of Groundwater Levels

12N02E09B002M

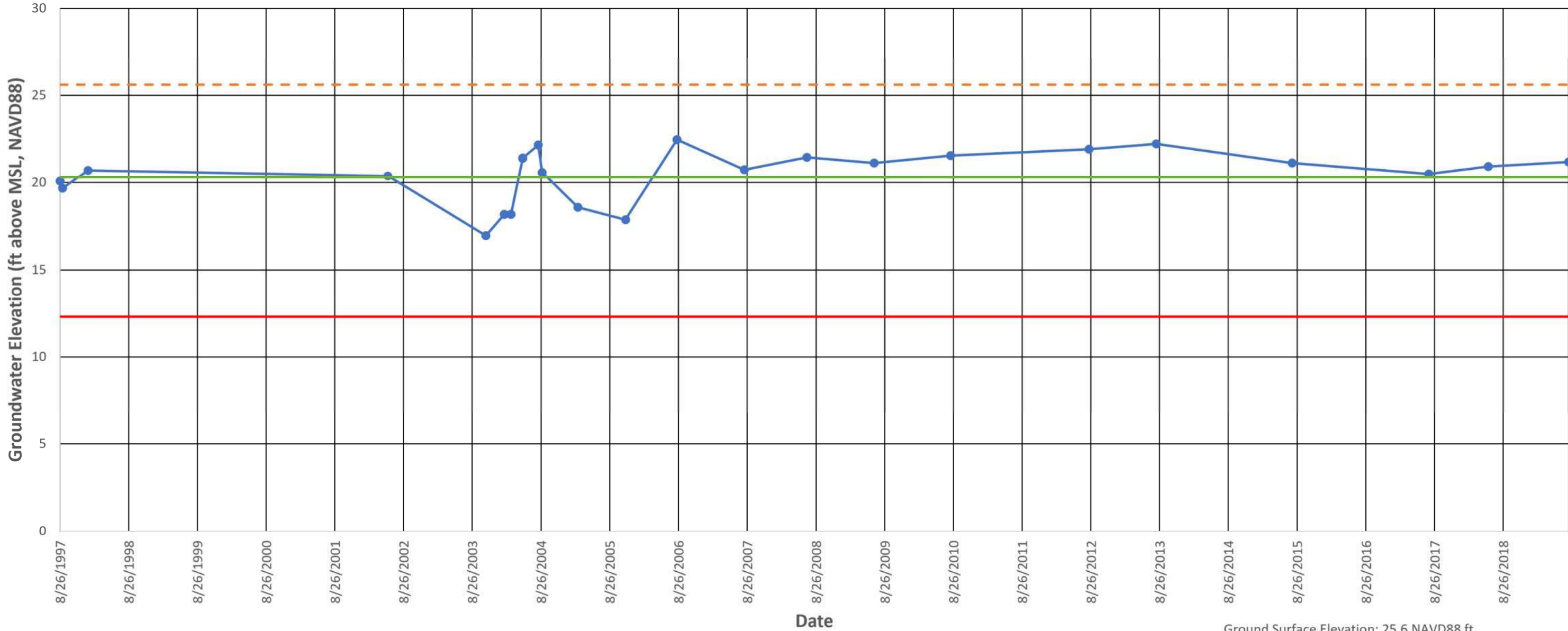

- Groundwater Level
- Ground Surface Elevation
- Measurable Objective
- Minimum Threshold

Operational Range: 8 ft
MT Method Selected: Minimum Operating Range

Site Code: N/A
SWN: 12N02E09B002M
Local ID: N/A
Other ID: USGS-385431121451401

Ground Surface Elevation: 25.6 NAVD88 ft
Depth: 29 ft bgs
Screen Interval - 1: N/A - N/A ft bgs
Screen Interval - 2: N/A - N/A ft bgs
Aquifer Zone: Shallow

12N03E18H001M

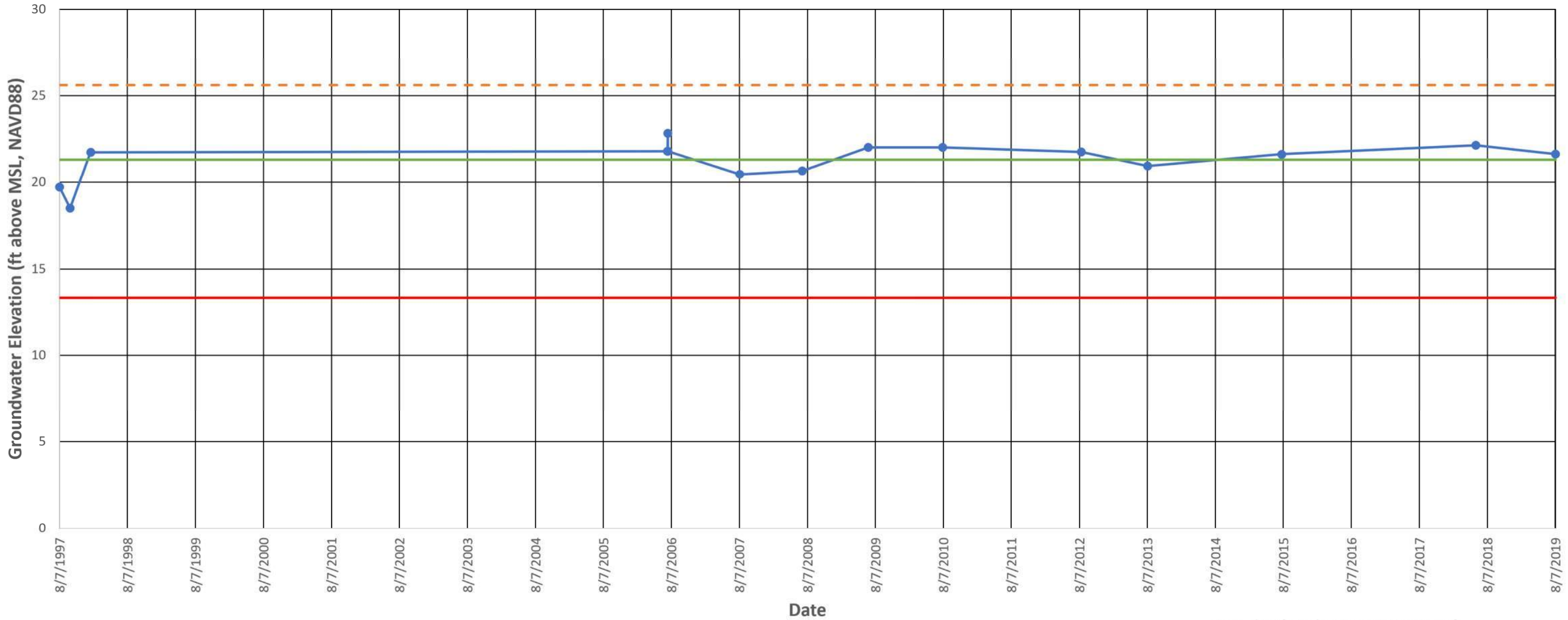

- Groundwater Level
- Ground Surface Elevation
- Measurable Objective
- Minimum Threshold

Operational Range: 8 ft
MT Method Selected: Minimum Operating Range

Site Code: N/A
SWN: 12N03E18H001M
Local ID: N/A
Other ID: USGS-385314121401701

Ground Surface Elevation: 25.6 NAVD88 ft
Depth: 50 ft bgs
Screen Interval - 1: N/A - N/A ft bgs
Screen Interval - 2: N/A - N/A ft bgs
Aquifer Zone: Shallow

14N02E10R001M

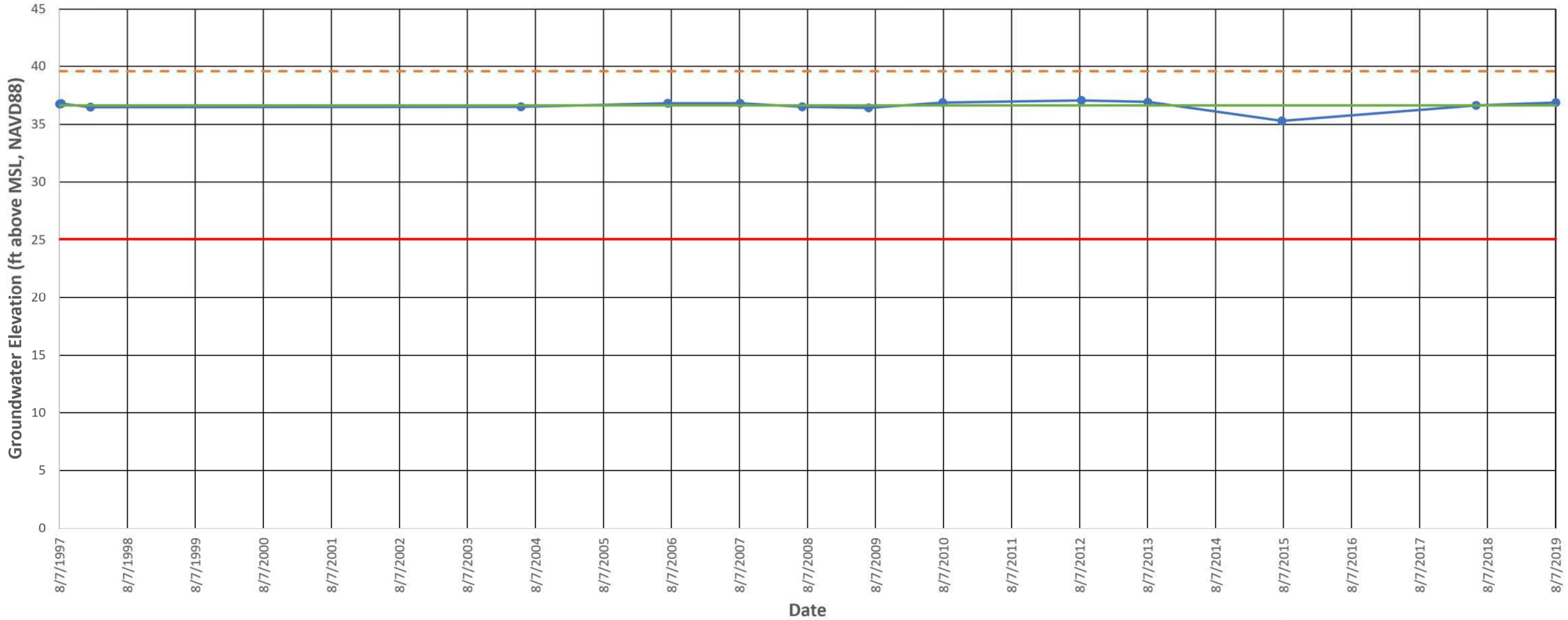

- Groundwater Level
- Ground Surface Elevation
- Measurable Objective
- Minimum Threshold

Operational Range: 11.55 ft
MT Method Selected: 90% avg projected elevation with +50% ET

Site Code: N/A
SWN: 14N02E10R001M
Local ID: N/A
Other ID: USGS-390416121433601

Ground Surface Elevation: 39.6 NAVD88 ft
Depth: 44 ft bgs
Screen Interval - 1: N/A - N/A ft bgs
Screen Interval - 2: N/A - N/A ft bgs
Aquifer Zone: Shallow

15N02E20D001M

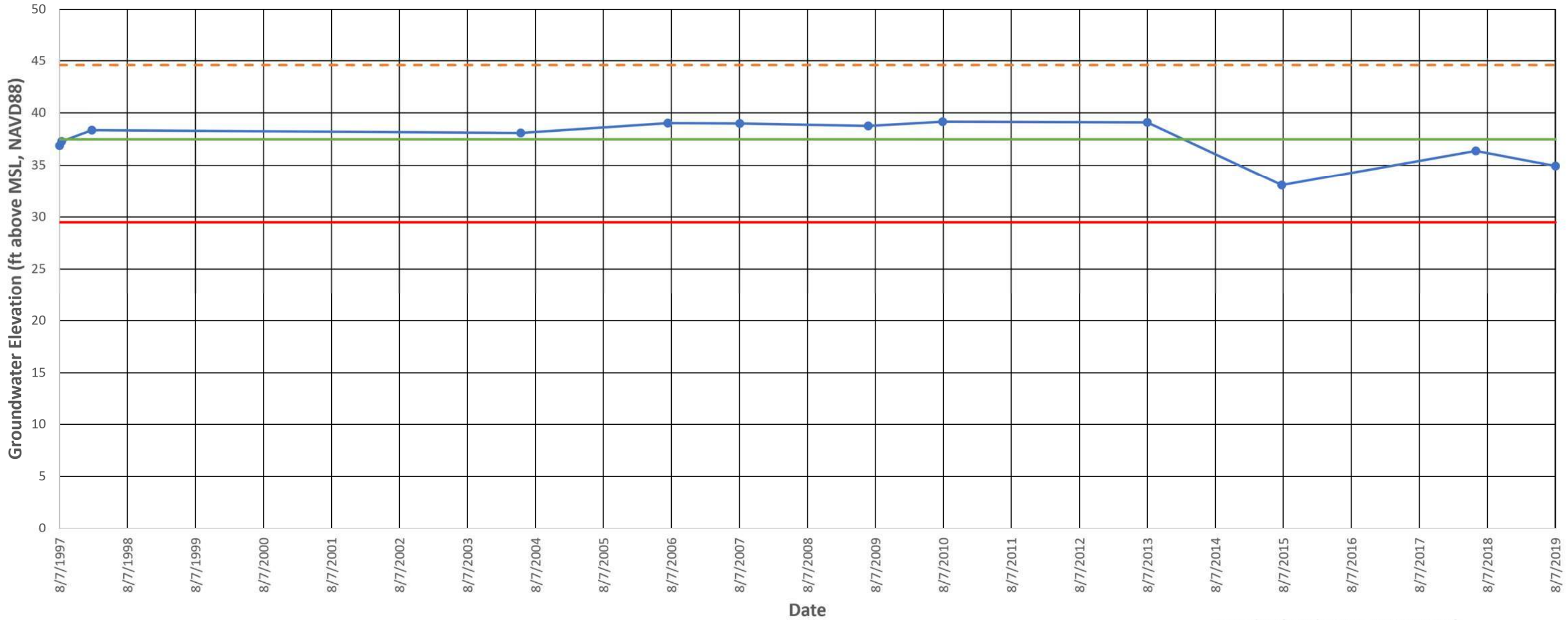

- Groundwater Level
- Ground Surface Elevation
- Measurable Objective
- Minimum Threshold

Operational Range: 8 ft
MT Method Selected: Minimum Operating Range

Site Code: N/A
SWN: 15N02E20D001M
Local ID: N/A
Other ID: USGS-390832121463601

Ground Surface Elevation: 44.6 NAVD88 ft
Depth: 35 ft bgs
Screen Interval - 1: N/A - N/A ft bgs
Screen Interval - 2: N/A - N/A ft bgs
Aquifer Zone: Shallow

16N01E31H001M

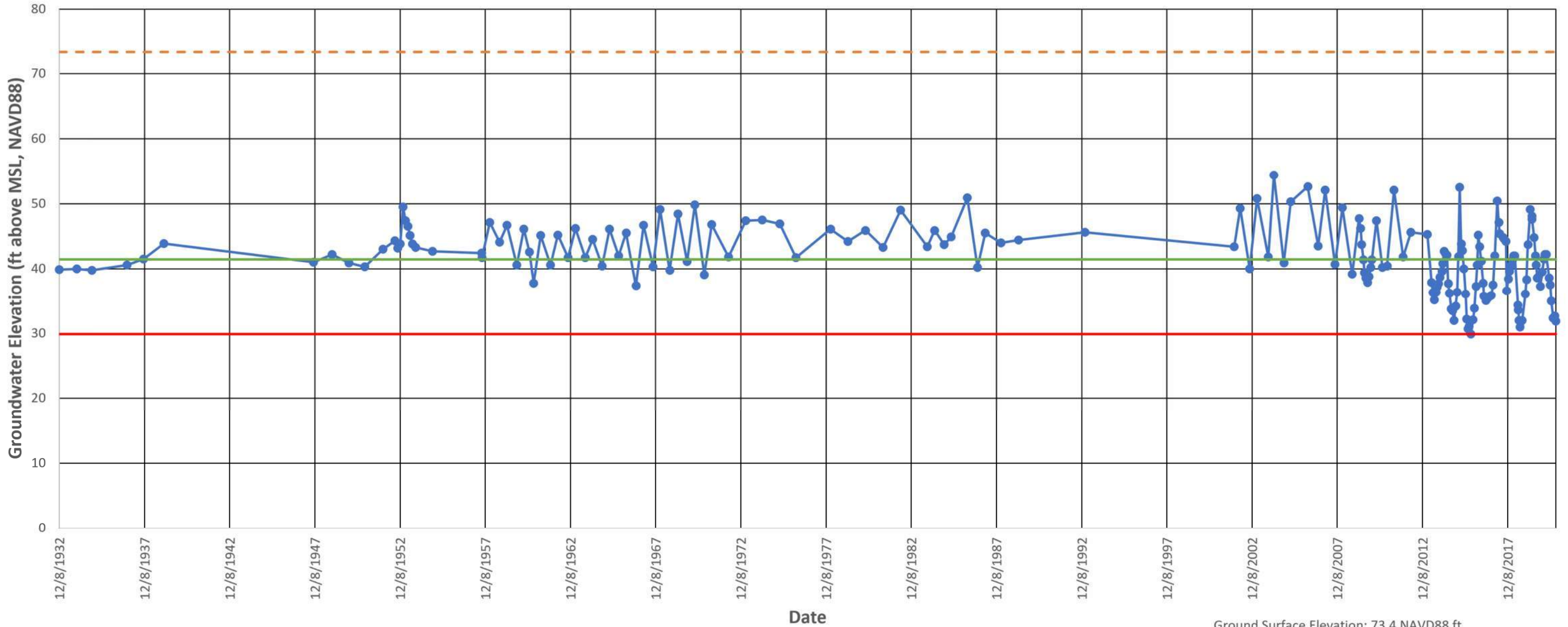

- Groundwater Level
- Ground Surface Elevation
- Measurable Objective
- Minimum Threshold

Operational Range: 11.56 ft
MT Method Selected: Historic Low

Site Code: 391975N1218937W001
SWN: 16N01E31H001M
Local ID: N/A
Other ID: N/A

Ground Surface Elevation: 73.4 NAVD88 ft
Depth: 0 ft bgs
Screen Interval - 1: N/A - N/A ft bgs
Screen Interval - 2: N/A - N/A ft bgs
Aquifer Zone: Shallow

16N03E21D002M

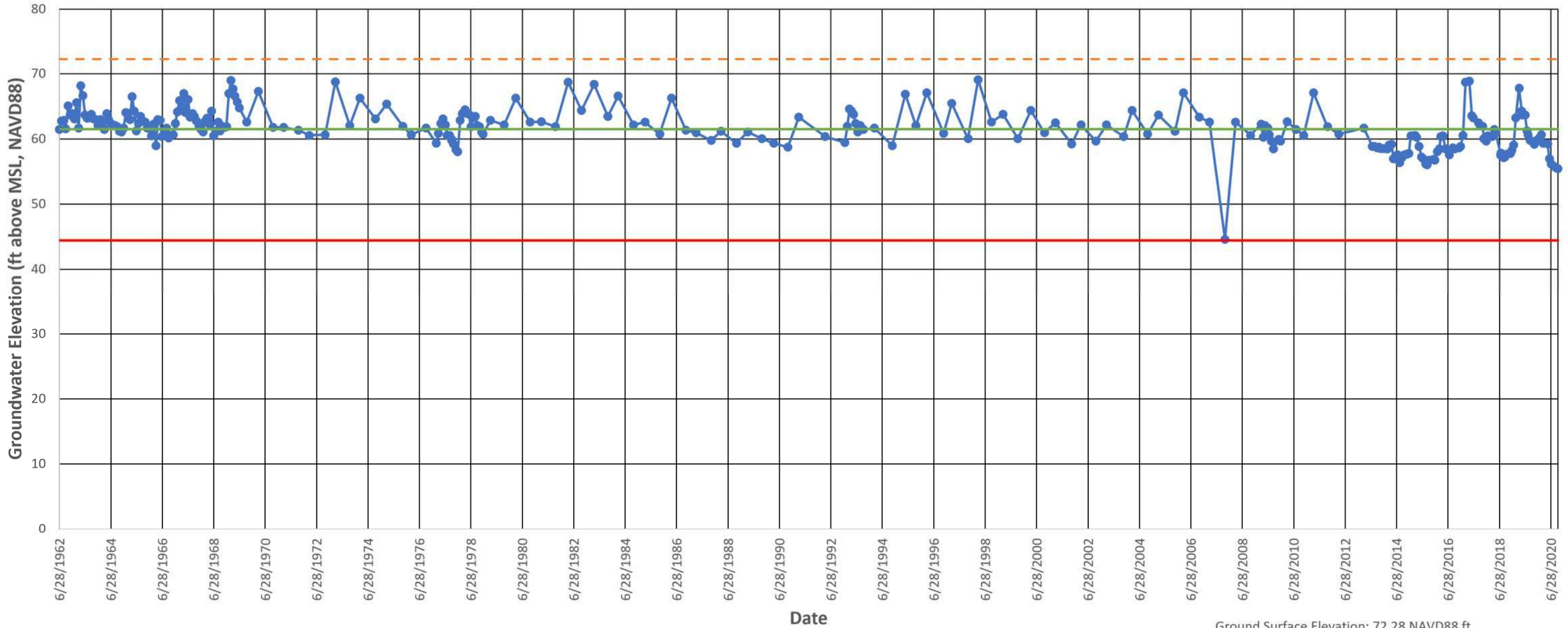

- Groundwater Level
- - - Ground Surface Elevation
- Measurable Objective
- Minimum Threshold

Operational Range: 17.1 ft
 MT Method Selected: 90% avg projected elevation with +50% ET

Site Code: 392328N1216469W001
 SWN: 16N03E21D002M
 Local ID: N/A
 Other ID: N/A

Ground Surface Elevation: 72.28 NAVD88 ft
 Depth: 0 ft bgs
 Screen Interval - 1: N/A - N/A ft bgs
 Screen Interval - 2: N/A - N/A ft bgs
 Aquifer Zone: Shallow

Sutter County MW-1A

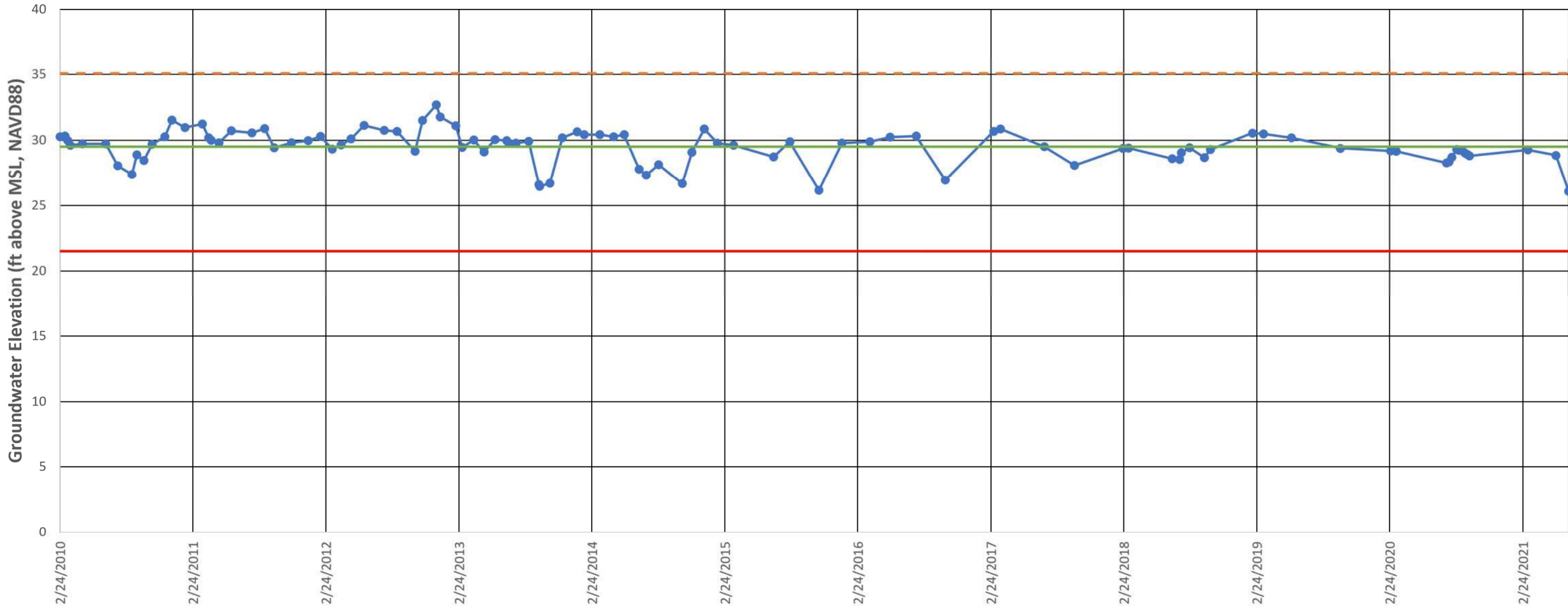

- Groundwater Level
- - - Ground Surface Elevation
- Measurable Objective
- Minimum Threshold

Operational Range: 8 ft
 MT Method Selected: Minimum Operating Range

Site Code: 390696N1217778W001
 SWN: 14N02E17C001M
 Local ID: Sutter County MW-1A
 Other ID: N/A

Ground Surface Elevation: 35.079 NAVD88 ft
 Depth: 60 ft bgs
 Screen Interval - 1: 30 - 50 ft bgs
 Screen Interval - 2: N/A - N/A ft bgs
 Aquifer Zone: Shallow

14N01E24N001M

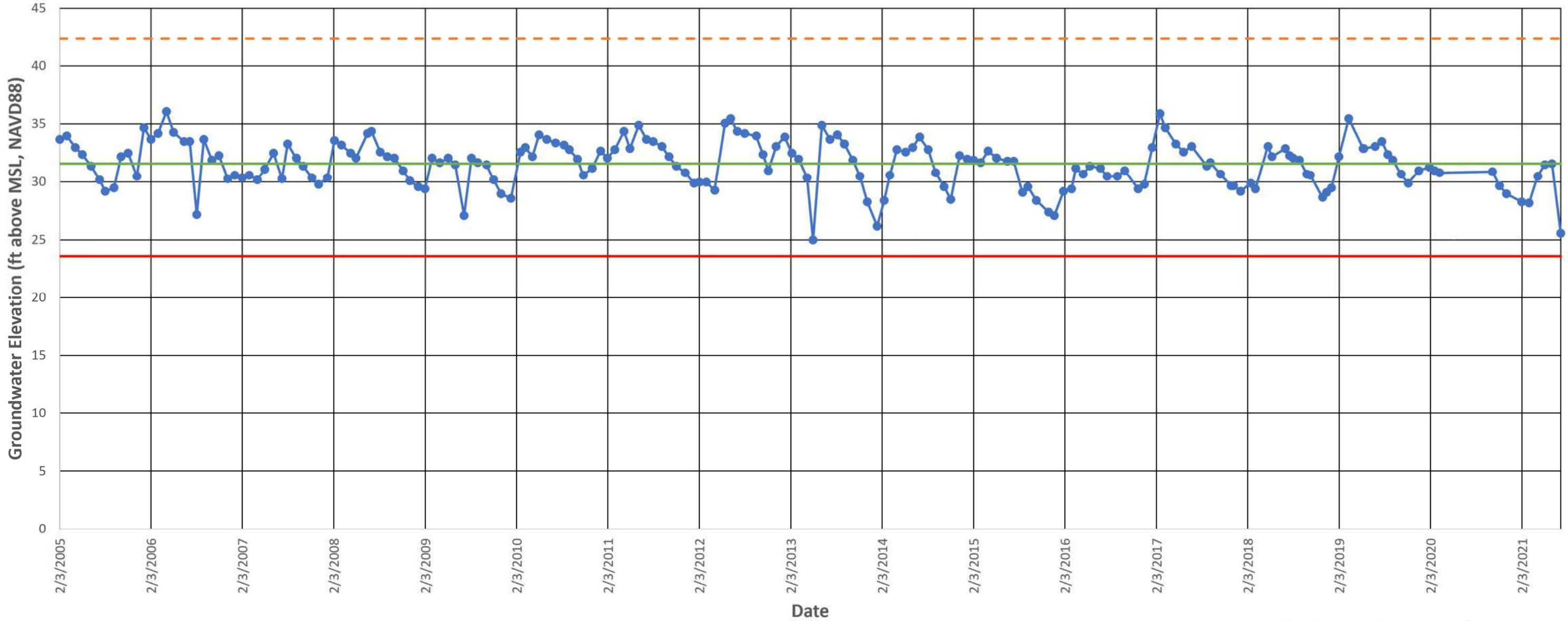

- Groundwater Level
- - - Ground Surface Elevation
- Measurable Objective
- Minimum Threshold

Operational Range: 8 ft
 MT Method Selected: Minimum Operating Range

Site Code: 390426N1218166W001
 SWN: 14N01E24N001M
 Local ID: N/A
 Other ID: N/A

Ground Surface Elevation: 42.38 NAVD88 ft
 Depth: 145 ft bgs
 Screen Interval - 1: N/A - N/A ft bgs
 Screen Interval - 2: N/A - N/A ft bgs
 Aquifer Zone: AZ-1

14N02E13L001M

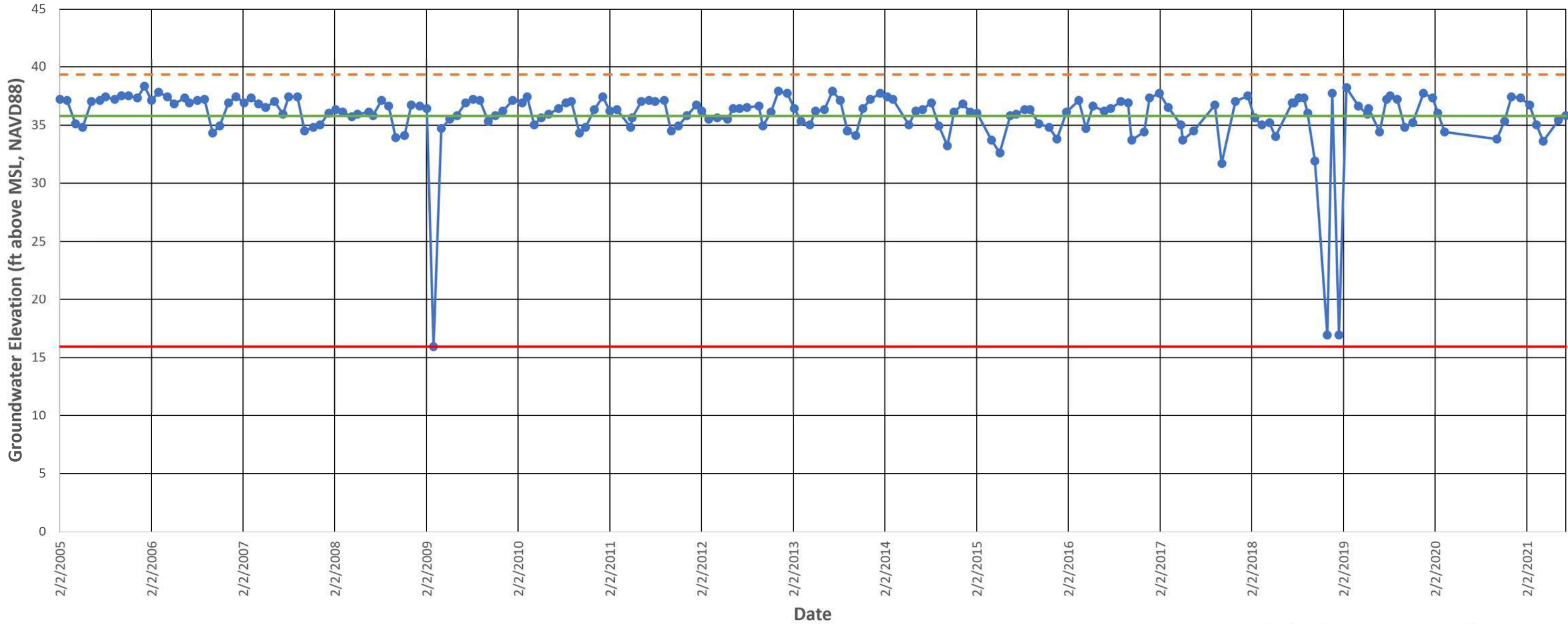

- Groundwater Level
- - - Ground Surface Elevation
- Measurable Objective
- Minimum Threshold

Operational Range: 19.87 ft
 MT Method Selected: Historic Low

Site Code: 390588N1217004W001
 SWN: 14N02E13L001M
 Local ID: N/A
 Other ID: N/A

Ground Surface Elevation: 39.33 NAVD88 ft
 Depth: 82 ft bgs
 Screen Interval - 1: 68 - 82 ft bgs
 Screen Interval - 2: N/A - N/A ft bgs
 Aquifer Zone: AZ-1

14N02E31K001M

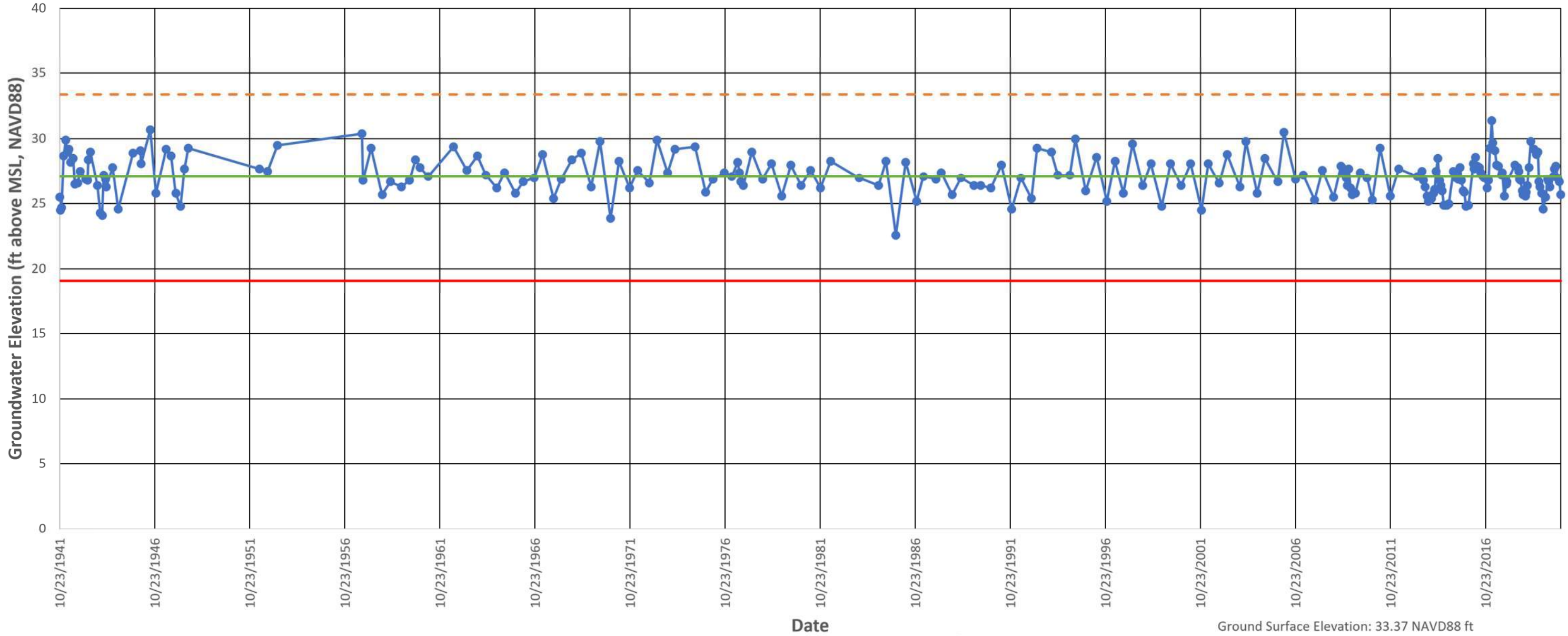

- Groundwater Level
- Ground Surface Elevation
- Measurable Objective
- Minimum Threshold

Operational Range: 8 ft
MT Method Selected: Minimum Operating Range

Site Code: 390176N1217902W001
SWN: 14N02E31K001M
Local ID: N/A
Other ID: N/A

Ground Surface Elevation: 33.37 NAVD88 ft
Depth: 131 ft bgs
Screen Interval - 1: N/A - N/A ft bgs
Screen Interval - 2: N/A - N/A ft bgs
Aquifer Zone: AZ-1

15N02E36L001M

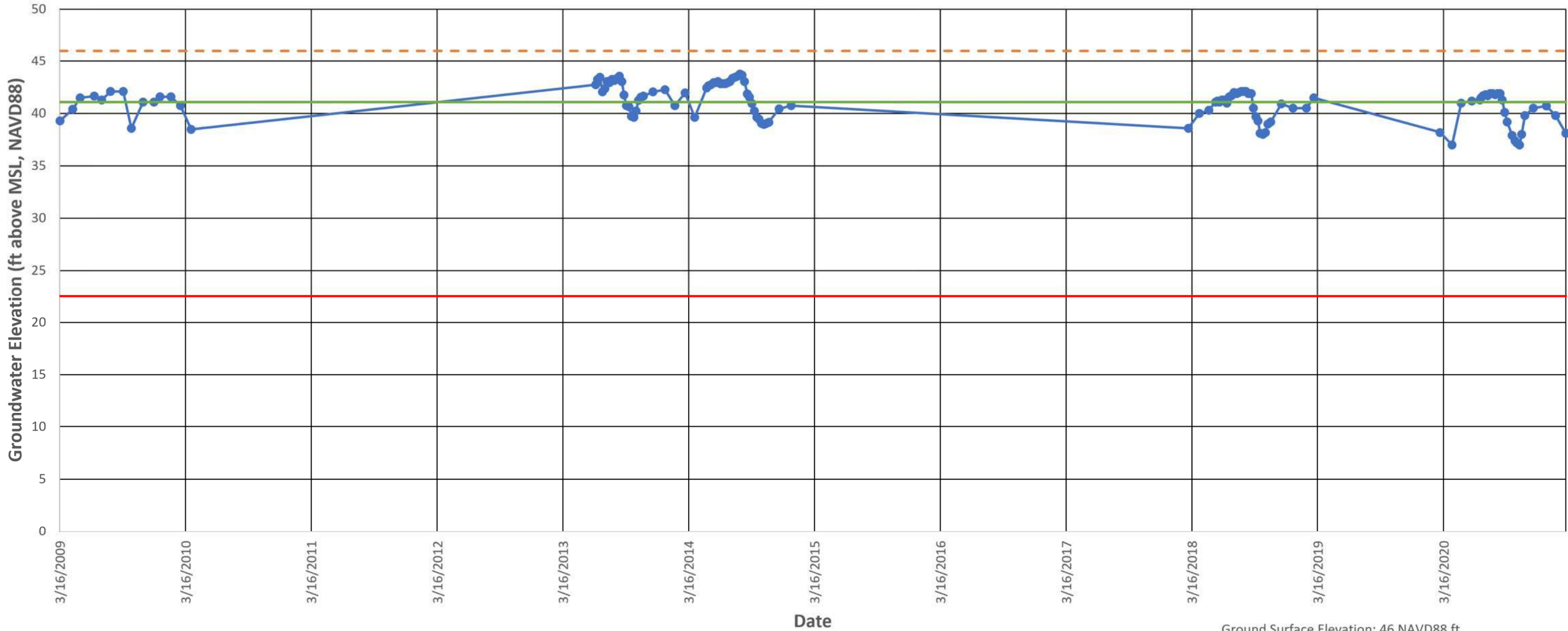

- Groundwater Level
- Ground Surface Elevation
- Measurable Objective
- Minimum Threshold

Operational Range: 18.55 ft
MT Method Selected: 90% avg projected elevation with +50% ET

Site Code: 391051N1217012W001
SWN: 15N02E36L001M
Local ID: N/A
Other ID: N/A

Ground Surface Elevation: 46 NAVD88 ft
Depth: 150 ft bgs
Screen Interval - 1: 100 - 150 ft bgs
Screen Interval - 2: N/A - N/A ft bgs
Aquifer Zone: AZ-1

16N03E04E001M



- Groundwater Level
- Ground Surface Elevation
- Measurable Objective
- Minimum Threshold

Operational Range: 8 ft
MT Method Selected: Minimum Operating Range

Site Code: 392712N1216493W001
SWN: 16N03E04E001M
Local ID: N/A
Other ID: N/A

Ground Surface Elevation: 61.27 NAVD88 ft
Depth: 70 ft bgs
Screen Interval - 1: N/A - N/A ft bgs
Screen Interval - 2: N/A - N/A ft bgs
Aquifer Zone: AZ-1

BWD MW-1C

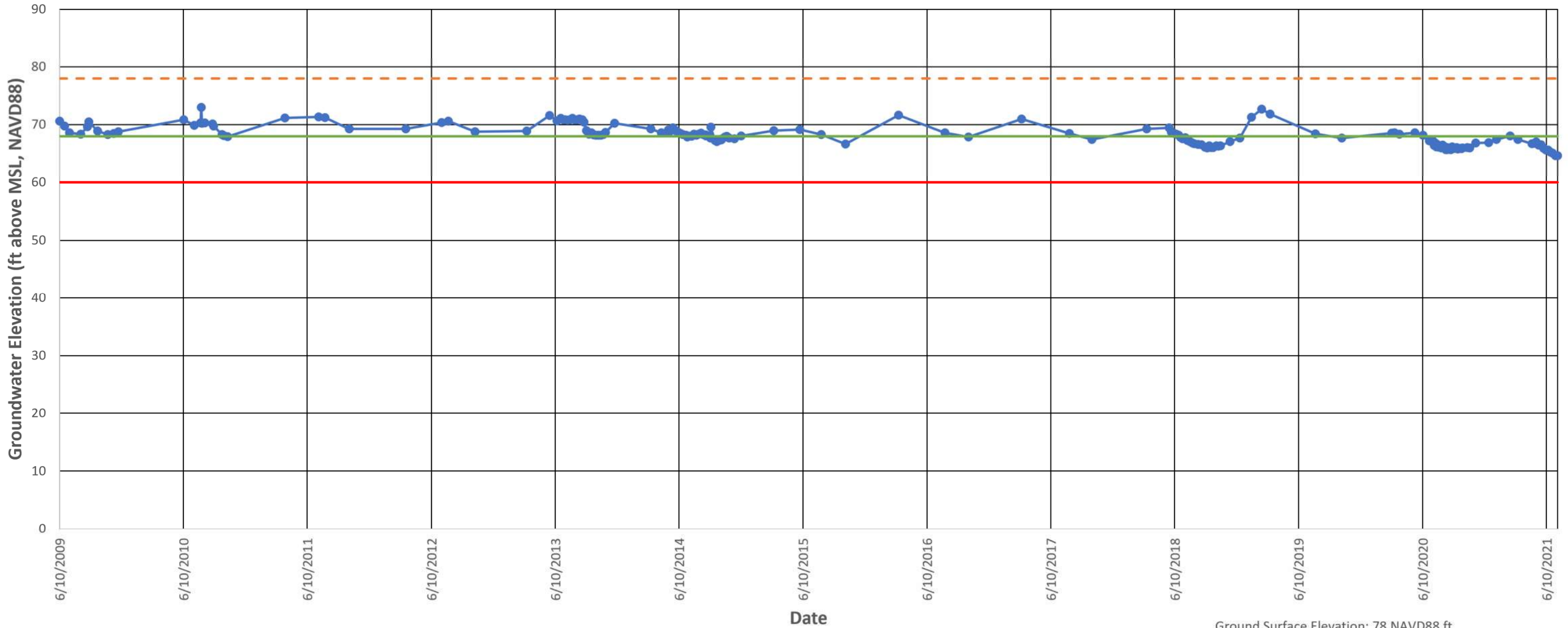

- Groundwater Level
- Ground Surface Elevation
- Measurable Objective
- Minimum Threshold

Operational Range: 8 ft
MT Method Selected: Minimum Operating Range

Site Code: 392970N1216907W003
SWN: 17N02E25J003M
Local ID: BWD MW-1C
Other ID: N/A

Ground Surface Elevation: 78 NAVD88 ft
Depth: 127 ft bgs
Screen Interval - 1: 70 - 90 ft bgs
Screen Interval - 2: N/A - N/A ft bgs
Aquifer Zone: AZ-1

Feather River MW-1A

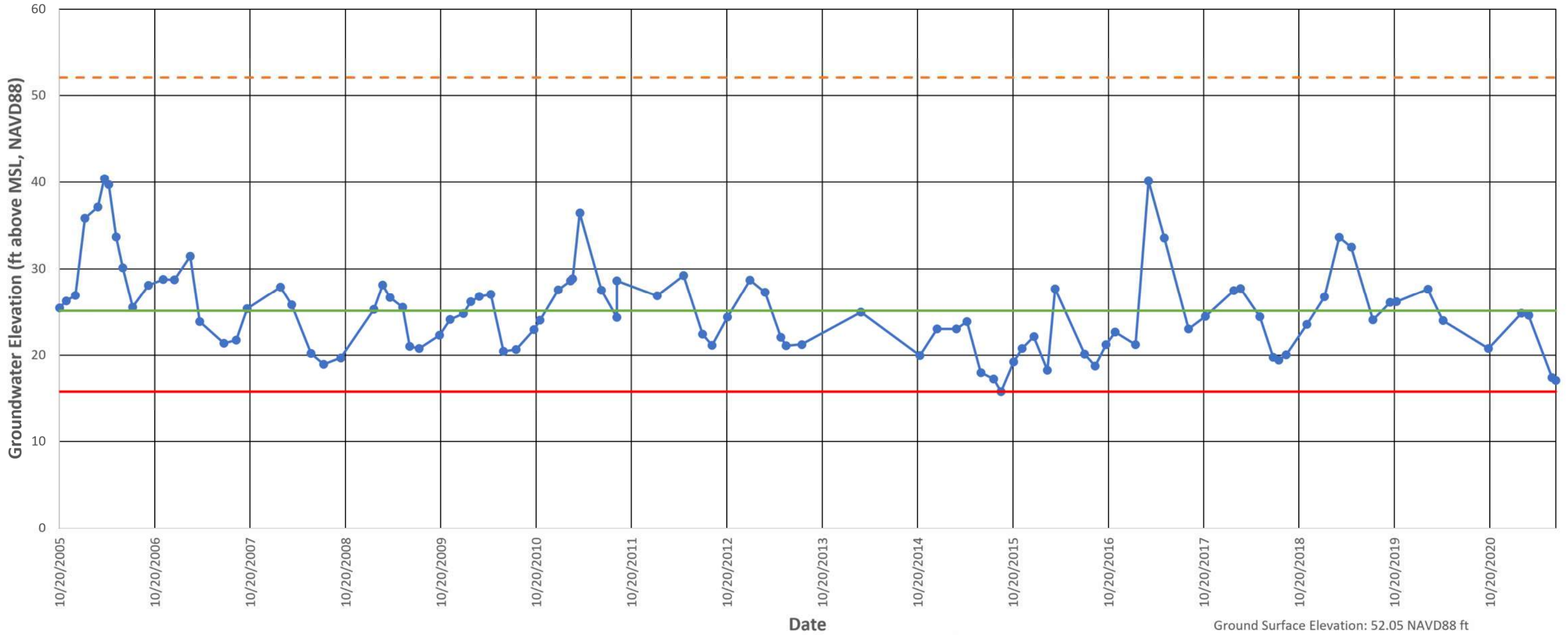

- Groundwater Level
- - - Ground Surface Elevation
- Measurable Objective
- Minimum Threshold

Operational Range: 9.36 ft
 MT Method Selected: Historic Low

Site Code: 390458N1216114W001
 SWN: 14N03E23D003M
 Local ID: Feather River MW-1A
 Other ID: N/A

Ground Surface Elevation: 52.05 NAVD88 ft
 Depth: 65 ft bgs
 Screen Interval - 1: 40 - 60 ft bgs
 Screen Interval - 2: N/A - N/A ft bgs
 Aquifer Zone: AZ-1

Flood MW-1C (shall)

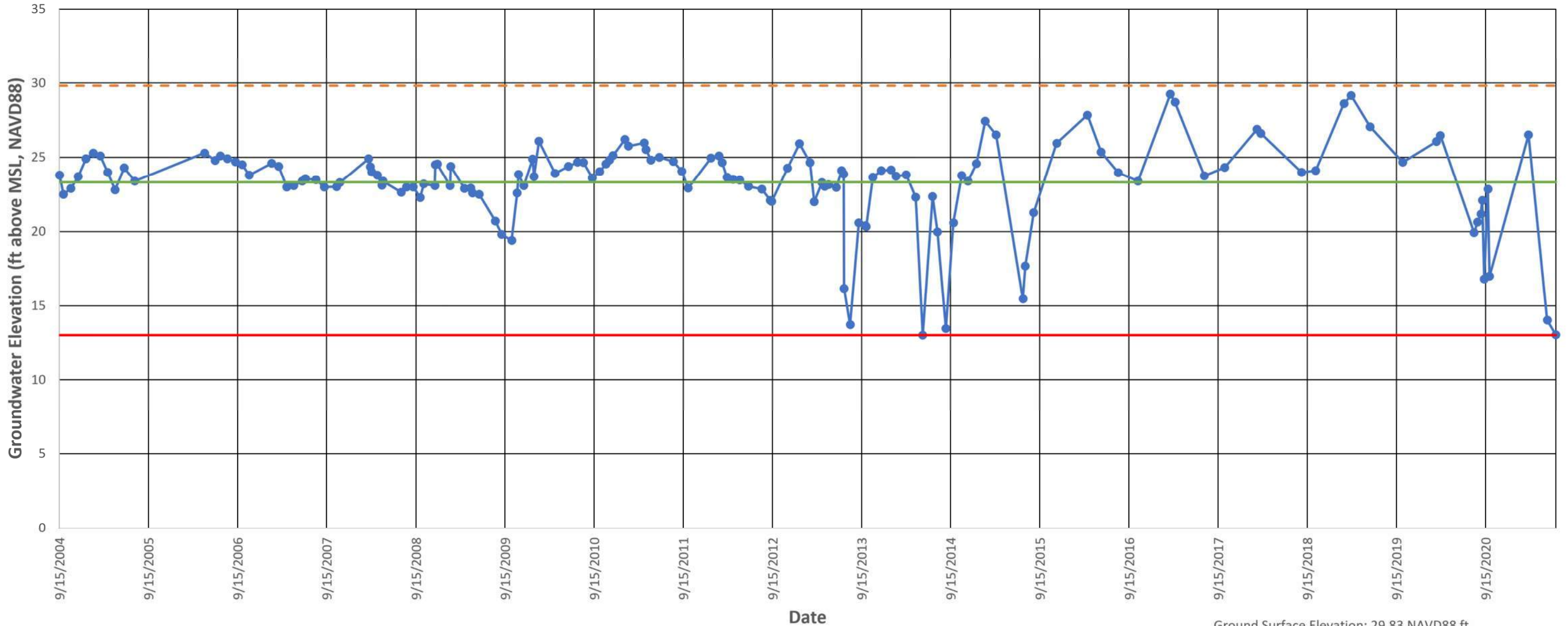

- Groundwater Level
- - - Ground Surface Elevation
- Measurable Objective
- Minimum Threshold

Operational Range: 10.33 ft
 MT Method Selected: Historic Low

Site Code: 389605N1218102W003
 SWN: 13N01E24G004M
 Local ID: Flood MW-1C (shall)
 Other ID: N/A

Ground Surface Elevation: 29.83 NAVD88 ft
 Depth: 100 ft bgs
 Screen Interval - 1: 70 - 90 ft bgs
 Screen Interval - 2: N/A - N/A ft bgs
 Aquifer Zone: AZ-1

GH Well 2

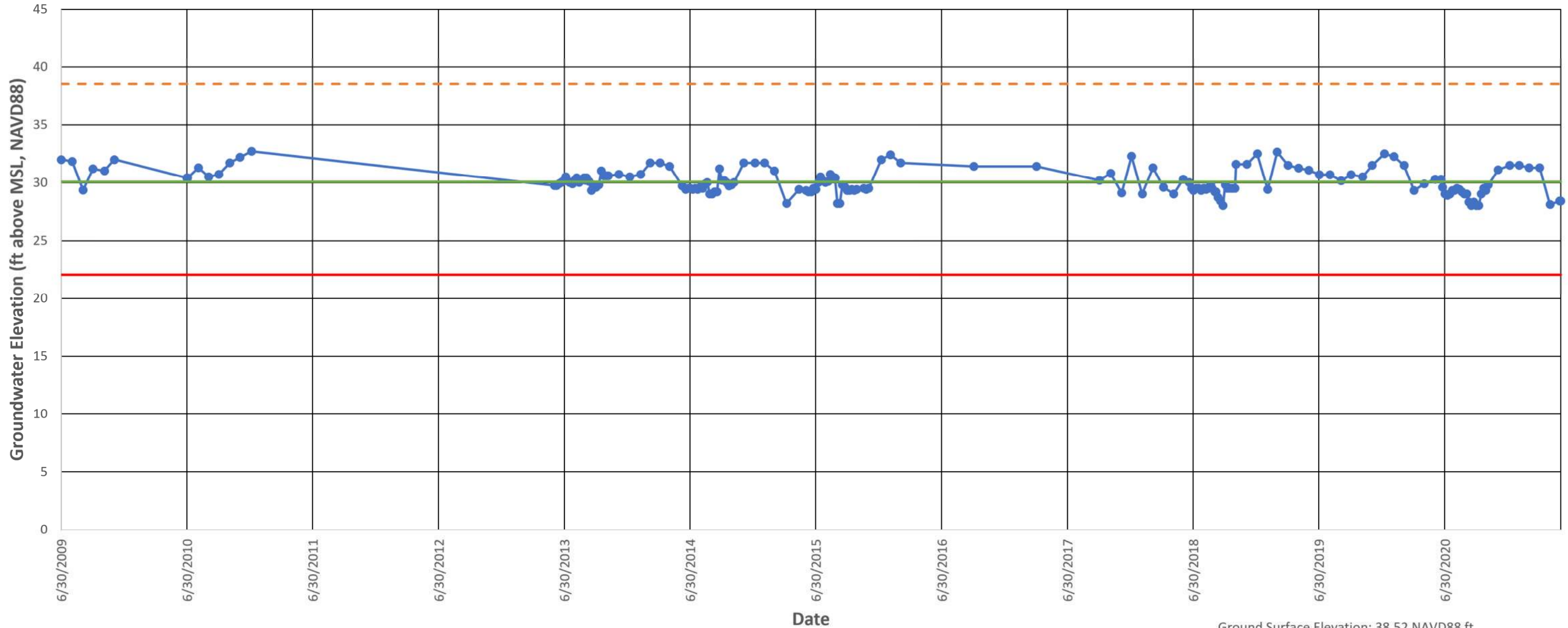

- Groundwater Level
- Ground Surface Elevation
- Measurable Objective
- Minimum Threshold

Operational Range: 8 ft
MT Method Selected: Minimum Operating Range

Site Code: 389453N1216159W001
SWN: N/A
Local ID: GH Well 2
Other ID: N/A

Ground Surface Elevation: 38.52 NAVD88 ft
Depth: 70 ft bgs
Screen Interval - 1: 50 - 70 ft bgs
Screen Interval - 2: N/A - N/A ft bgs
Aquifer Zone: AZ-1

MFWC Prop 50

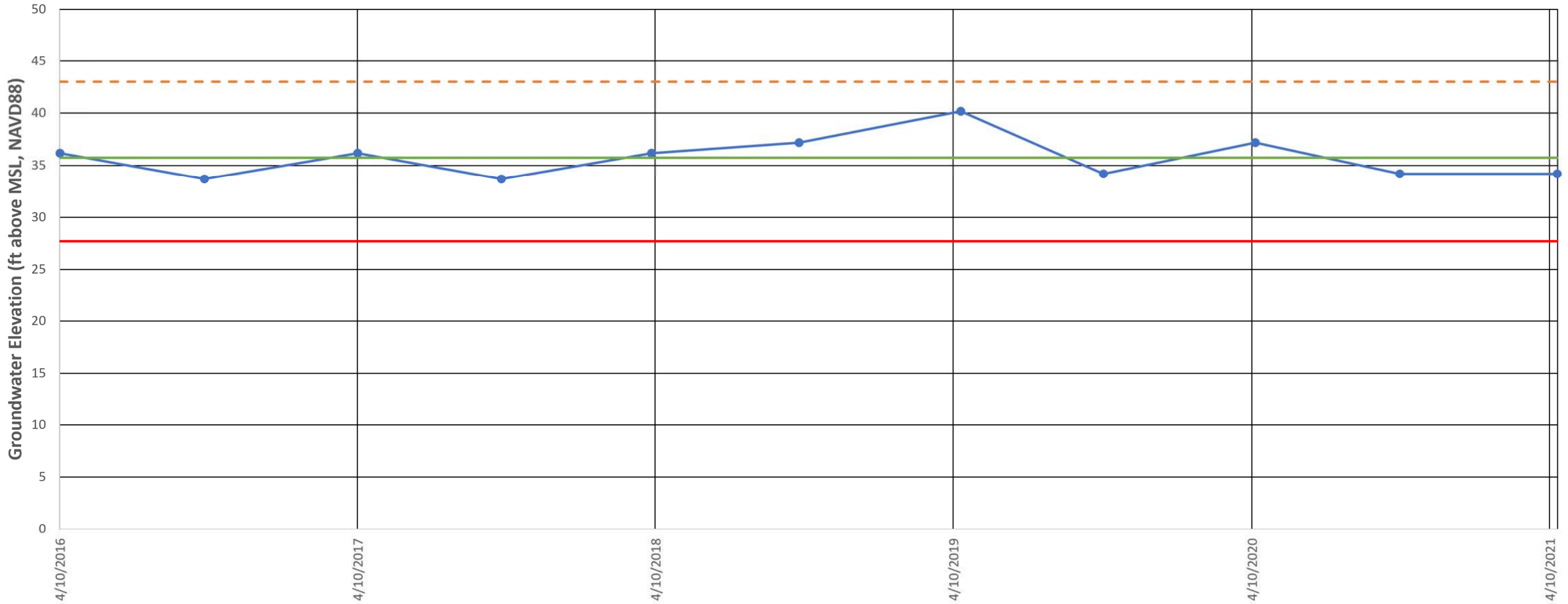

Date

- Groundwater Level
- Ground Surface Elevation
- Measurable Objective
- Minimum Threshold

Operational Range: 8 ft
MT Method Selected: Minimum Operating Range

Site Code: 391456N1218904W001
SWN: N/A
Local ID: MFWC Prop 50
Other ID: N/A

Ground Surface Elevation: 43.01 NAVD88 ft
Depth: 320 ft bgs
Screen Interval - 1: 125 - 155 ft bgs
Screen Interval - 2: 280 - 310 ft bgs
Aquifer Zone: AZ-1

RD 1500 Karnak

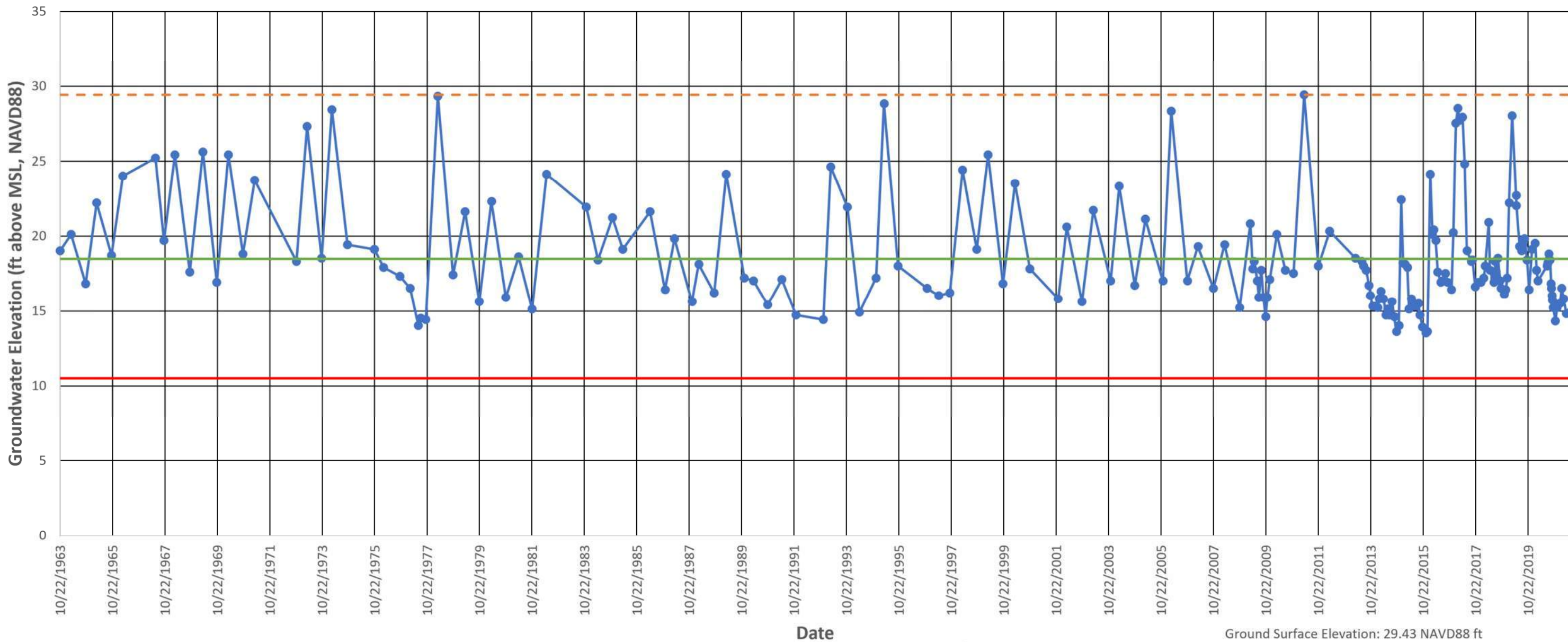

- Groundwater Level
- - - Ground Surface Elevation
- Measurable Objective
- Minimum Threshold

Operational Range: 8 ft
 MT Method Selected: Minimum Operating Range

Site Code: 387859N1216565W001
 SWN: 11N03E20H003M
 Local ID: RD 1500 Karnak
 Other ID: N/A

Ground Surface Elevation: 29.43 NAVD88 ft
 Depth: 165 ft bgs
 Screen Interval - 1: 135 - 156 ft bgs
 Screen Interval - 2: N/A - N/A ft bgs
 Aquifer Zone: AZ-1

SEWD MW-3A

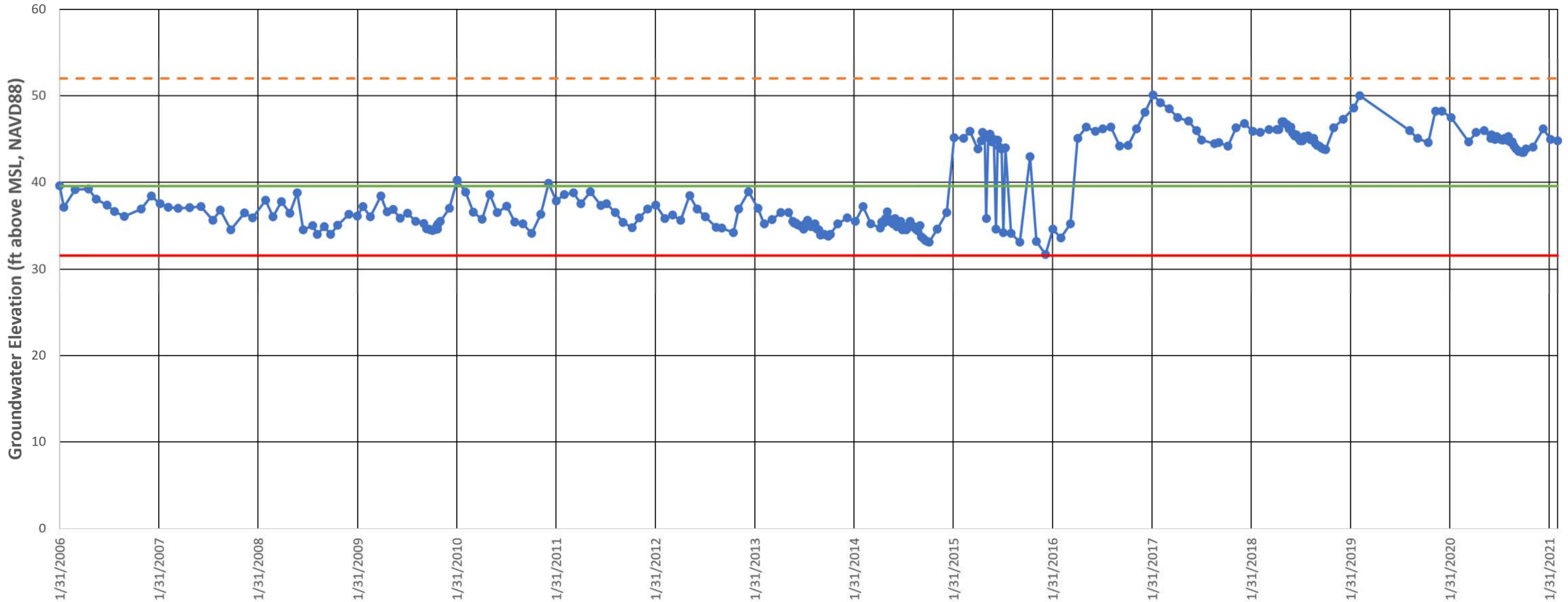

Date

- Groundwater Level
- - - Ground Surface Elevation
- Measurable Objective
- Minimum Threshold

Operational Range: 8 ft
 MT Method Selected: Minimum Operating Range

Site Code: 390682N1216901W001
 SWN: 14N02E13A003M
 Local ID: SEWD MW-3A
 Other ID: N/A

Ground Surface Elevation: 52 NAVD88 ft
 Depth: 115 ft bgs
 Screen Interval - 1: 90 - 110 ft bgs
 Screen Interval - 2: N/A - N/A ft bgs
 Aquifer Zone: AZ-1

SMWC MW-1A

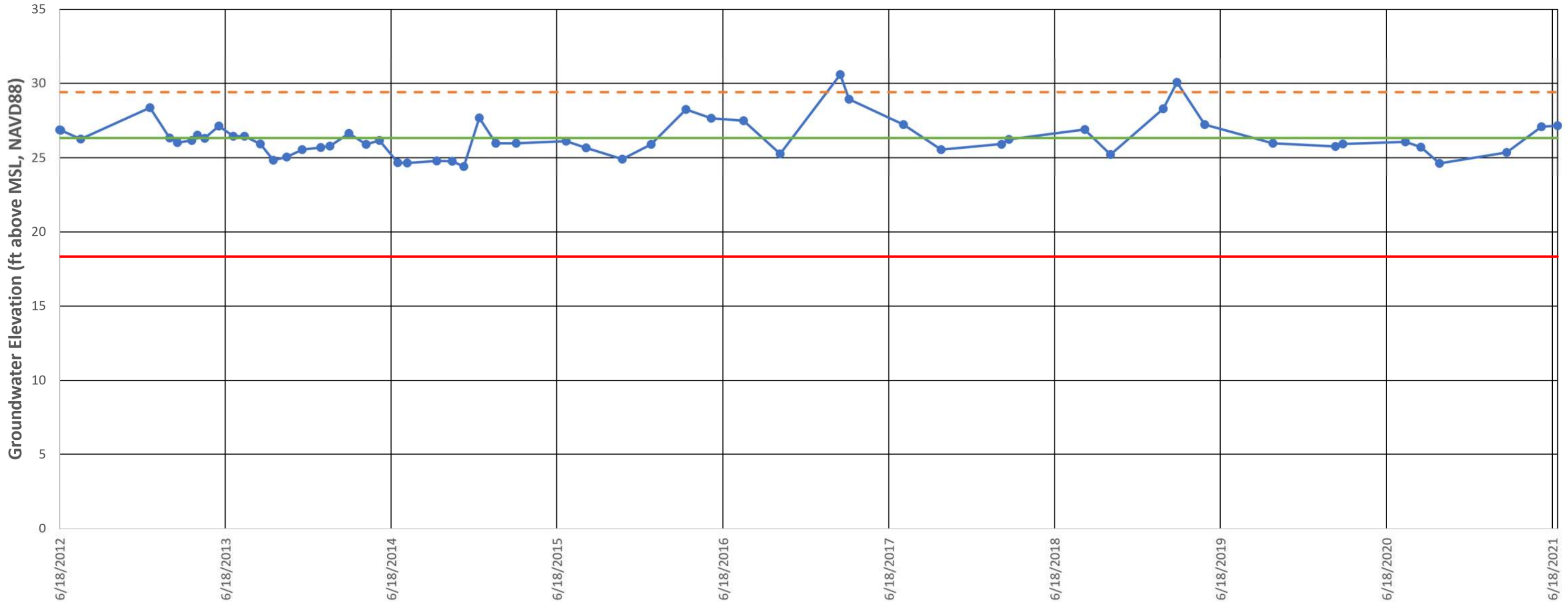

Date

- Groundwater Level
- - - Ground Surface Elevation
- Measurable Objective
- Minimum Threshold

Operational Range: 8 ft
 MT Method Selected: Minimum Operating Range

Site Code: 390244N1217813W001
 SWN: 14N02E32D001M
 Local ID: SMWC MW-1A
 Other ID: N/A

Ground Surface Elevation: 29.4 NAVD88 ft
 Depth: 64 ft bgs
 Screen Interval - 1: 34 - 54 ft bgs
 Screen Interval - 2: N/A - N/A ft bgs
 Aquifer Zone: AZ-1

Sutter County MW-2A

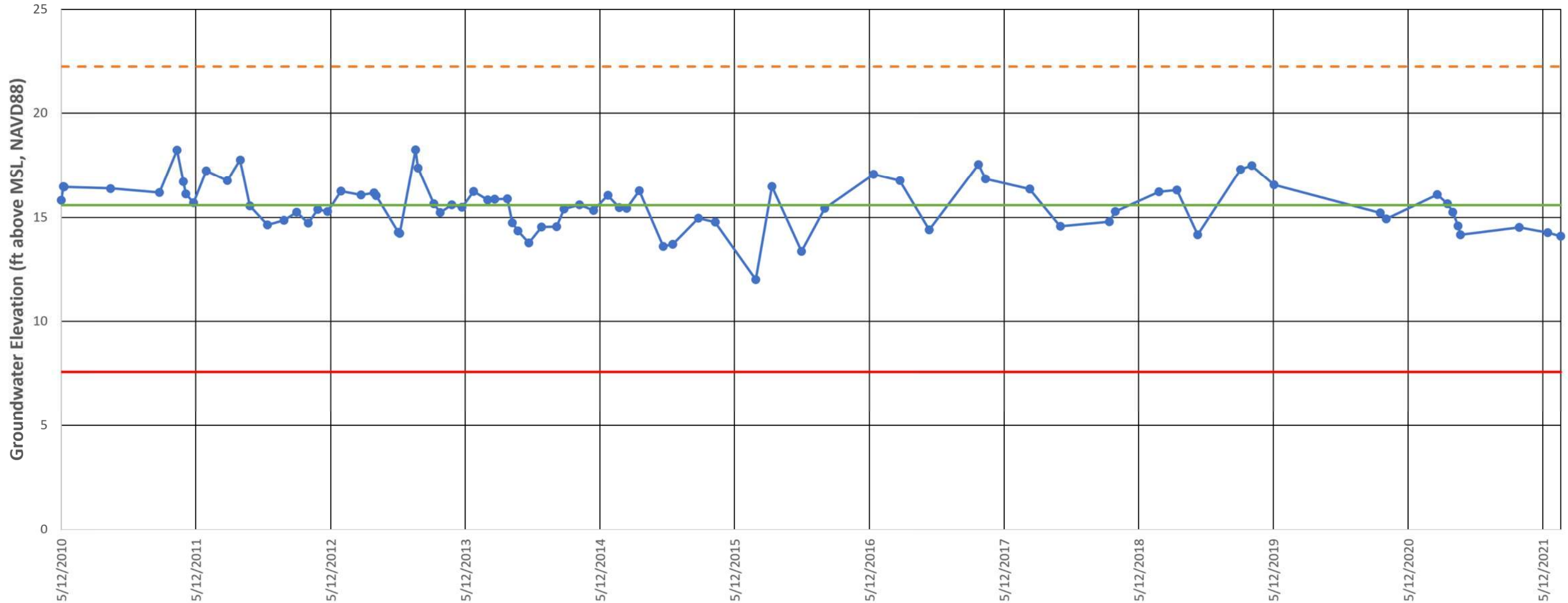

Date

- Groundwater Level
- - - Ground Surface Elevation
- Measurable Objective
- Minimum Threshold

Operational Range: 8 ft
 MT Method Selected: Minimum Operating Range

Site Code: 388761N1217094W001
 SWN: 12N02E23H001M
 Local ID: Sutter County MW-2A
 Other ID: N/A

Ground Surface Elevation: 22.236 NAVD88 ft
 Depth: 150 ft bgs
 Screen Interval - 1: 120 - 140 ft bgs
 Screen Interval - 2: N/A - N/A ft bgs
 Aquifer Zone: AZ-1

Sutter County MW-3A

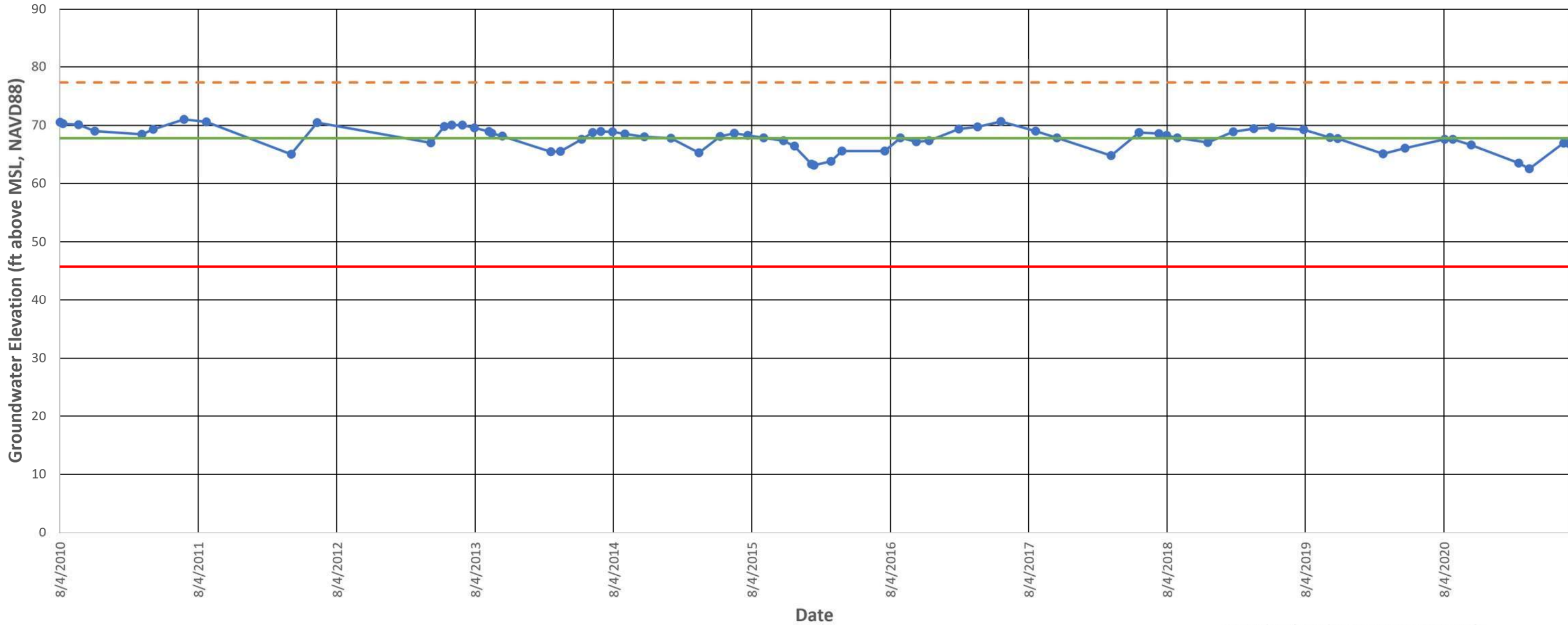

- Groundwater Level
- - - Ground Surface Elevation
- Measurable Objective
- Minimum Threshold

Operational Range: 22.02 ft
 MT Method Selected: 90% avg projected elevation with +50% ET

Site Code: 392394N1216509W001
 SWN: 16N03E17J001M
 Local ID: Sutter County MW-3A
 Other ID: N/A

Ground Surface Elevation: 77.35 NAVD88 ft
 Depth: 85 ft bgs
 Screen Interval - 1: 65 - 75 ft bgs
 Screen Interval - 2: N/A - N/A ft bgs
 Aquifer Zone: AZ-1

Sutter County MW-6A

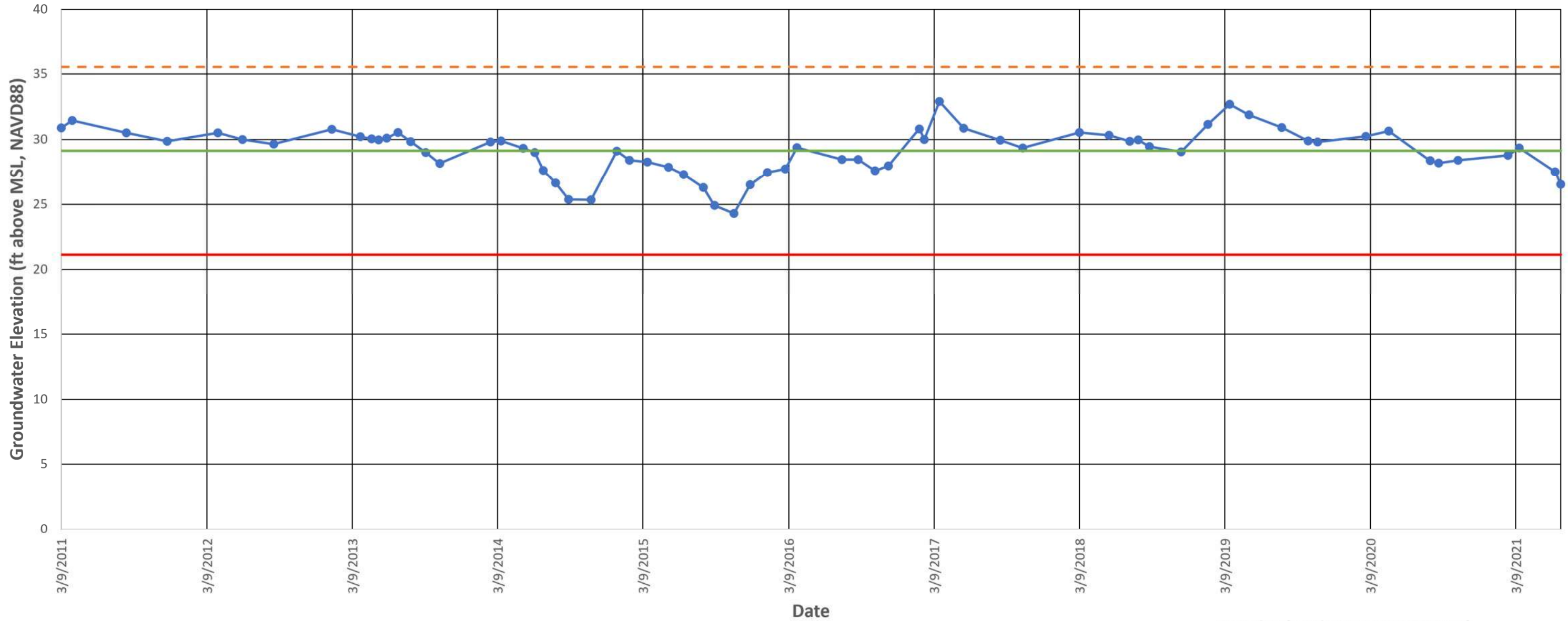

- Groundwater Level
- - - Ground Surface Elevation
- Measurable Objective
- Minimum Threshold

Operational Range: 8 ft
 MT Method Selected: Minimum Operating Range

Site Code: 390087N1216722W001
 SWN: 13N03E06A001M
 Local ID: Sutter County MW-6A
 Other ID: N/A

Ground Surface Elevation: 35.55 NAVD88 ft
 Depth: 65 ft bgs
 Screen Interval - 1: 45 - 55 ft bgs
 Screen Interval - 2: N/A - N/A ft bgs
 Aquifer Zone: AZ-1

Hillcrest Well #5

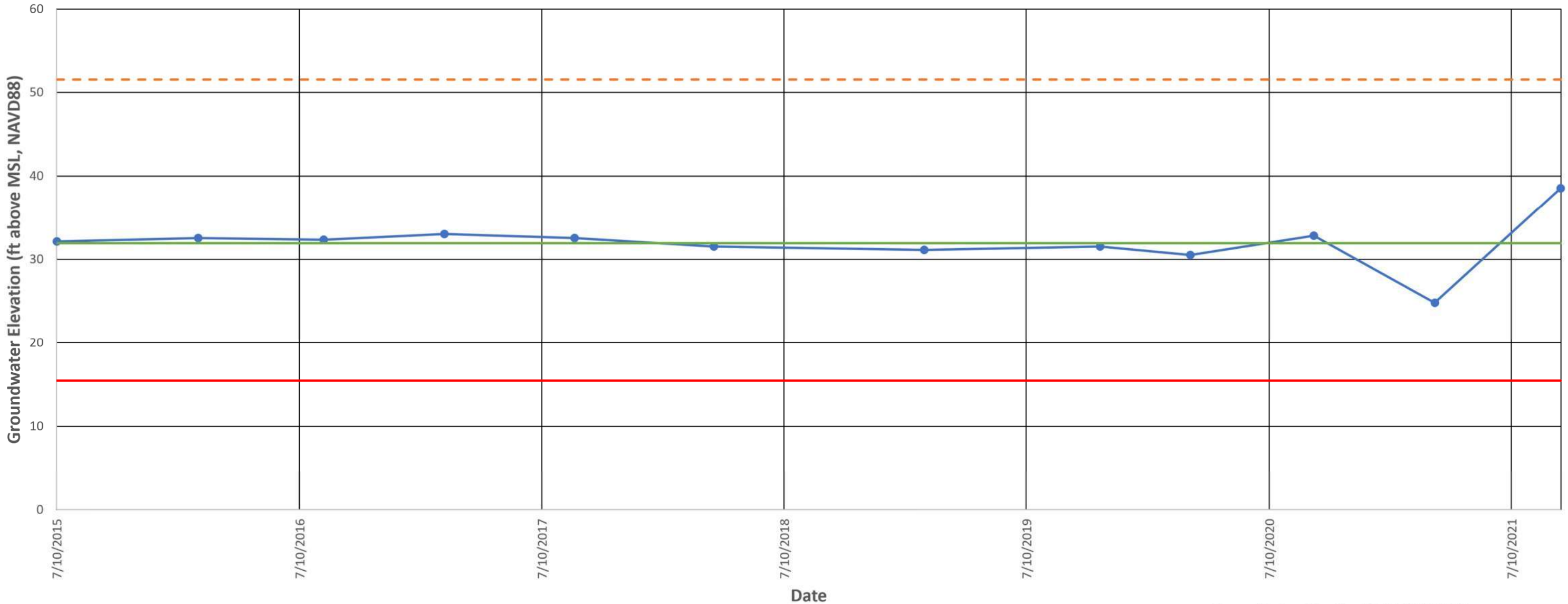

- Groundwater Level
- Ground Surface Elevation
- Measurable Objective
- Minimum Threshold

Operational Range: 16.5 ft
MT Method Selected: Minimum Operating Range

Site Code: N/A
SWN: N/A
Local ID: Hillcrest Well #5
Other ID: N/A

Ground Surface Elevation: 51.547 NAVD88 ft
Depth: 320 ft bgs
Screen Interval - 1: 94 - 118 ft bgs
Screen Interval - 2: 166 - 180 ft bgs
Screen Interval - 3: 264 - 288 ft bgs
Aquifer Zone: AZ-1 and AZ-2

15N02E22D001M

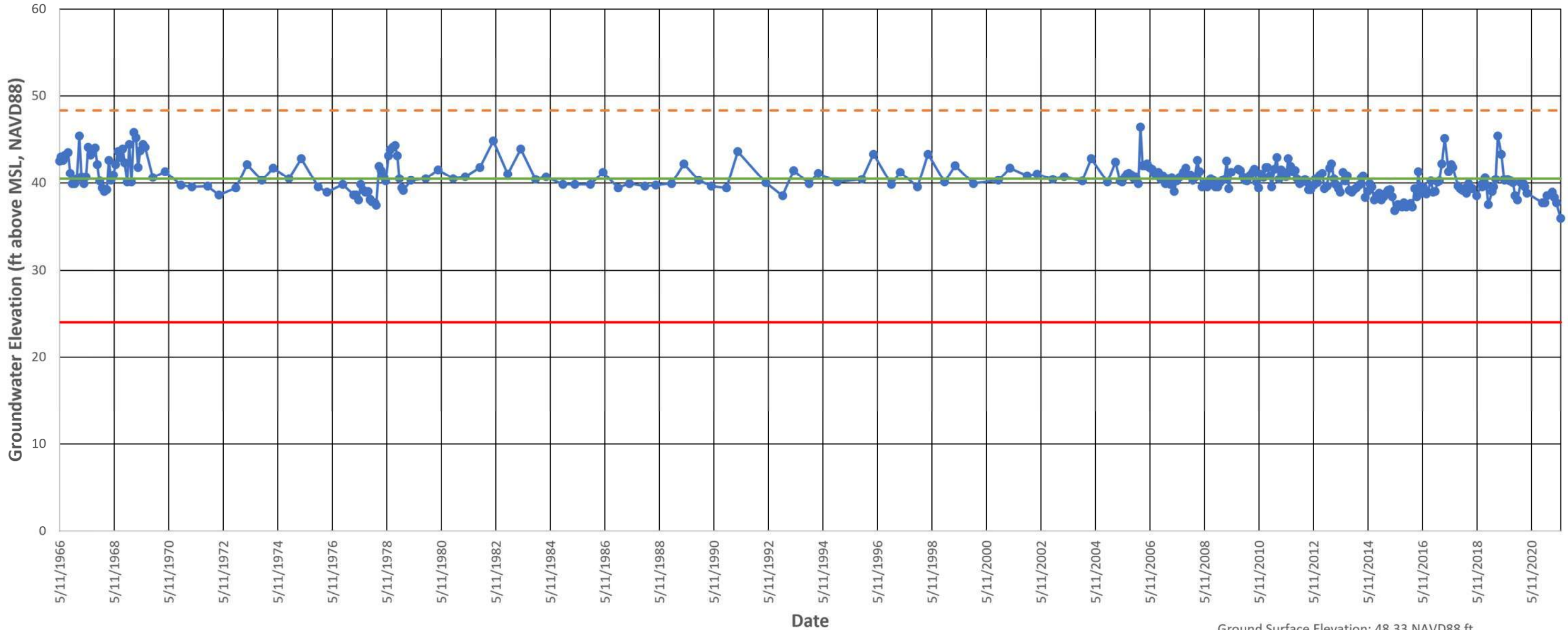

- Groundwater Level
- Ground Surface Elevation
- Measurable Objective
- Minimum Threshold

Operational Range: 16.5 ft
MT Method Selected: Minimum Operating Range

Site Code: 391414N1217442W001
SWN: 15N02E22D001M
Local ID: N/A
Other ID: N/A

Ground Surface Elevation: 48.33 NAVD88 ft
Depth: 302 ft bgs
Screen Interval - 1: N/A - N/A ft bgs
Screen Interval - 2: N/A - N/A ft bgs
Aquifer Zone: AZ-2

BS2-Franklin

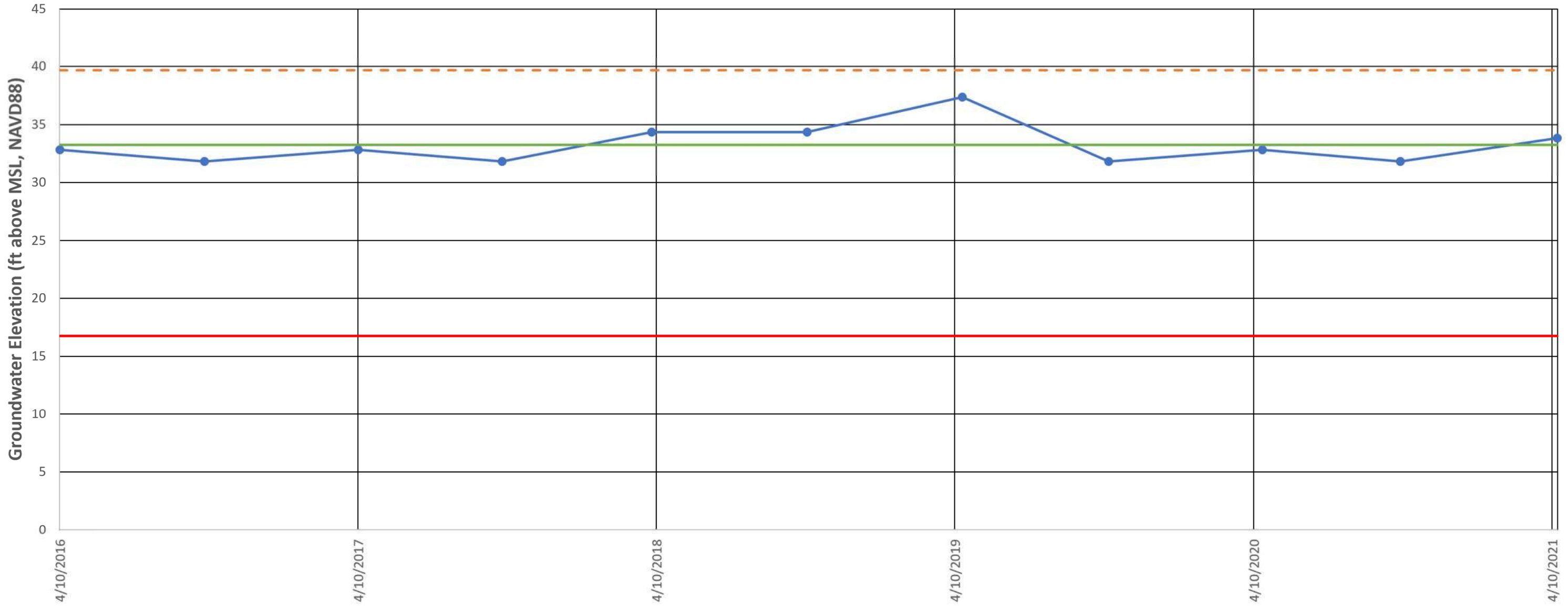

Date

- Groundwater Level
- Ground Surface Elevation
- Measurable Objective
- Minimum Threshold

Operational Range: 16.5 ft
MT Method Selected: Minimum Operating Range

Site Code: 391283N1218286W001
SWN: N/A
Local ID: BS2-Franklin
Other ID: N/A

Ground Surface Elevation: 39.69 NAVD88 ft
Depth: 300 ft bgs
Screen Interval - 1: N/A - N/A ft bgs
Screen Interval - 2: N/A - N/A ft bgs
Aquifer Zone: AZ-2

BWD MW-1B

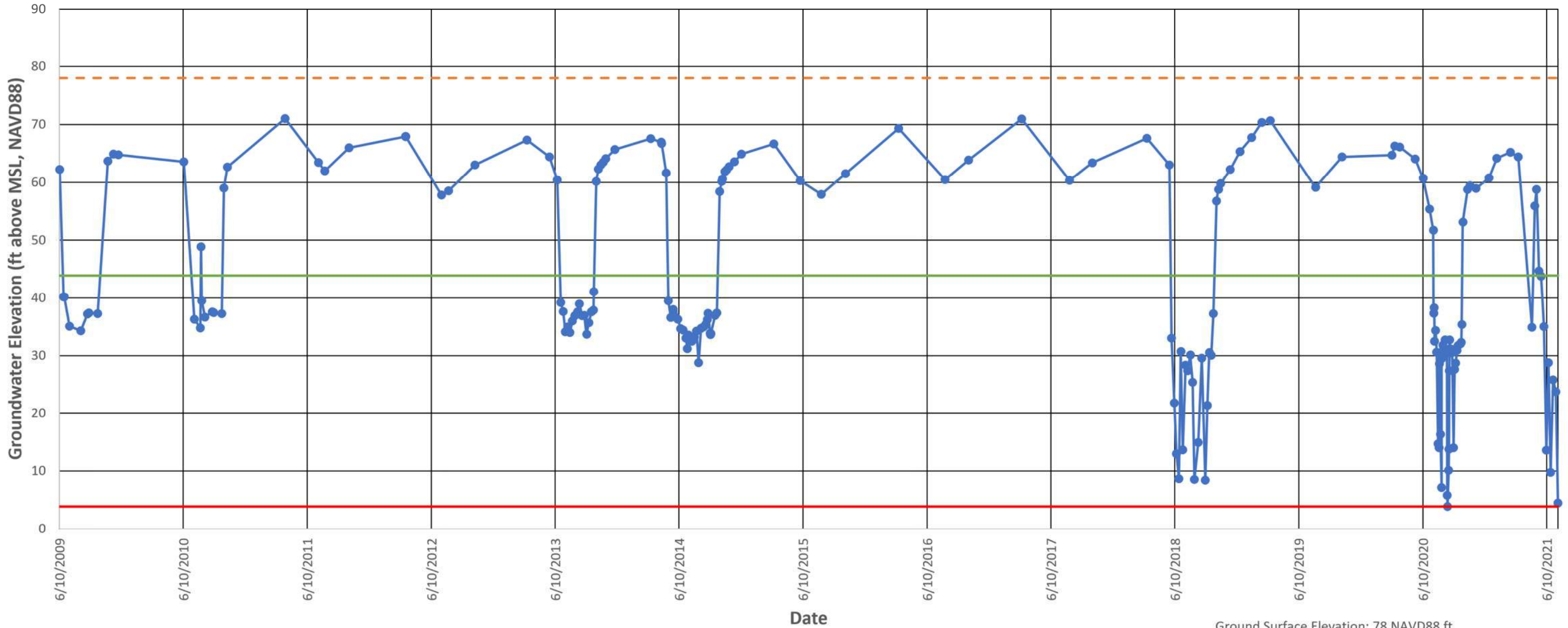

- Groundwater Level
- - - Ground Surface Elevation
- Measurable Objective
- Minimum Threshold

Operational Range: 39.99 ft
 MT Method Selected: Historic Low

Site Code: 392970N1216907W002
 SWN: 17N02E25J002M
 Local ID: BWD MW-1B
 Other ID: N/A

Ground Surface Elevation: 78 NAVD88 ft
 Depth: 370 ft bgs
 Screen Interval - 1: 320 - 360 ft bgs
 Screen Interval - 2: N/A - N/A ft bgs
 Aquifer Zone: AZ-2

Feather River MW-1B

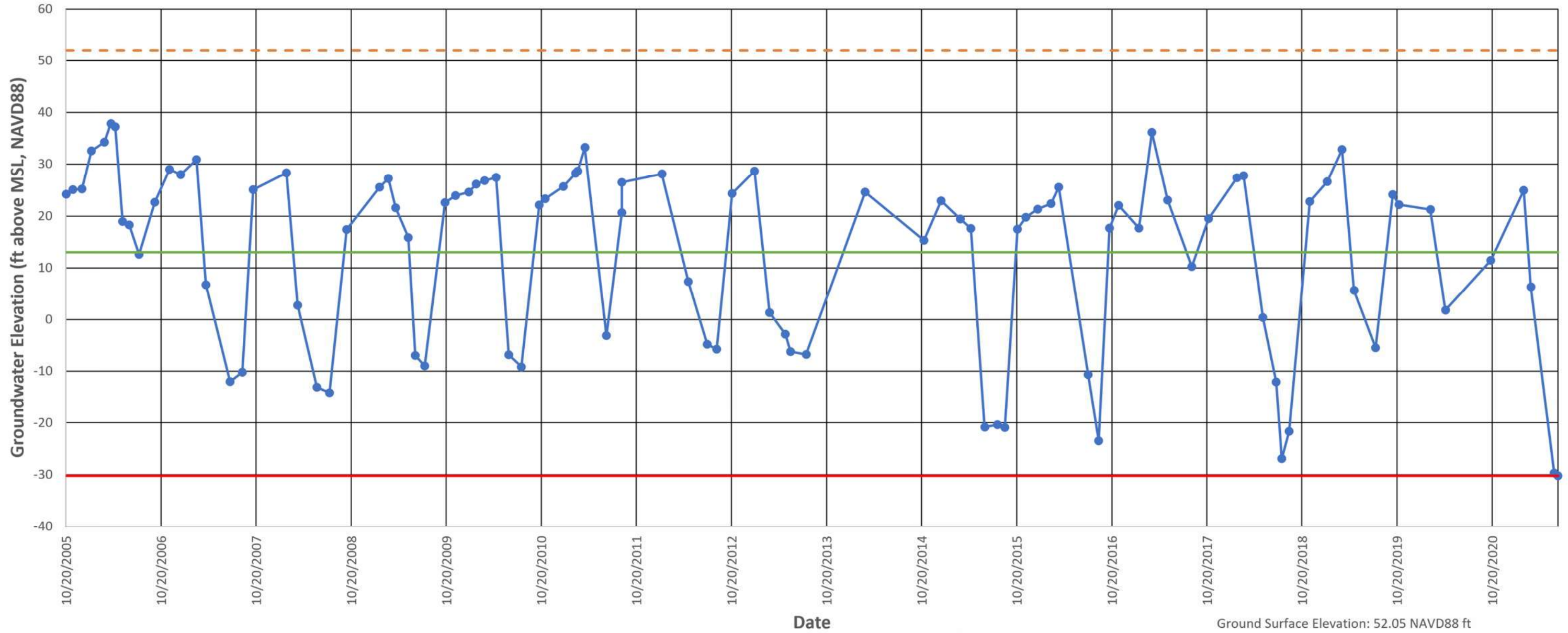

- Groundwater Level
- - - Ground Surface Elevation
- Measurable Objective
- Minimum Threshold

Operational Range: 43.19 ft
 MT Method Selected: Historic Low

Site Code: 390458N1216114W002
 SWN: 14N03E23D004M
 Local ID: Feather River MW-1B
 Other ID: N/A

Ground Surface Elevation: 52.05 NAVD88 ft
 Depth: 260 ft bgs
 Screen Interval - 1: 235 - 255 ft bgs
 Screen Interval - 2: N/A - N/A ft bgs
 Aquifer Zone: AZ-2

Flood MW-1A (deep)

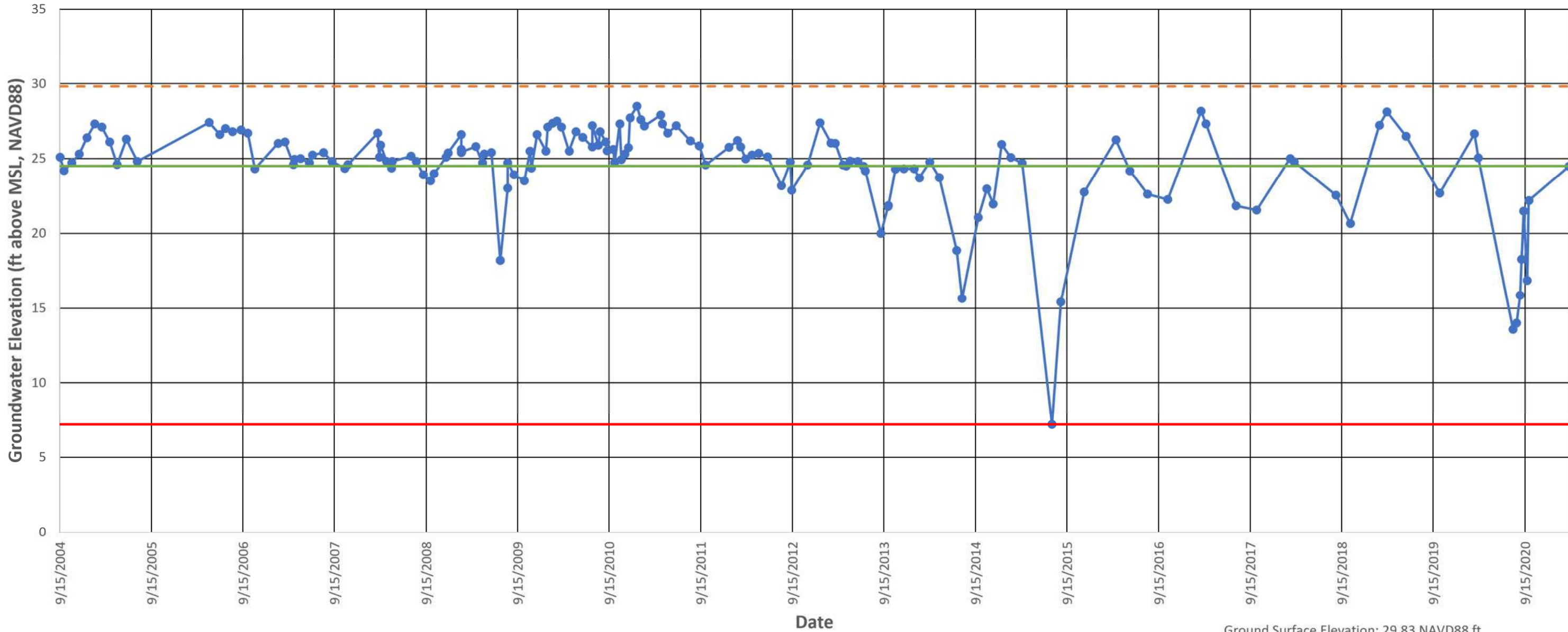

- Groundwater Level
- - - Ground Surface Elevation
- Measurable Objective
- Minimum Threshold

Operational Range: 17.3 ft
 MT Method Selected: Historic Low

Site Code: 389605N1218102W001
 SWN: 13N01E24G002M
 Local ID: Flood MW-1A (deep)
 Other ID: N/A

Ground Surface Elevation: 29.83 NAVD88 ft
 Depth: 310 ft bgs
 Screen Interval - 1: 240 - 300 ft bgs
 Screen Interval - 2: N/A - N/A ft bgs
 Aquifer Zone: AZ-2

Flood MW-1B (int)

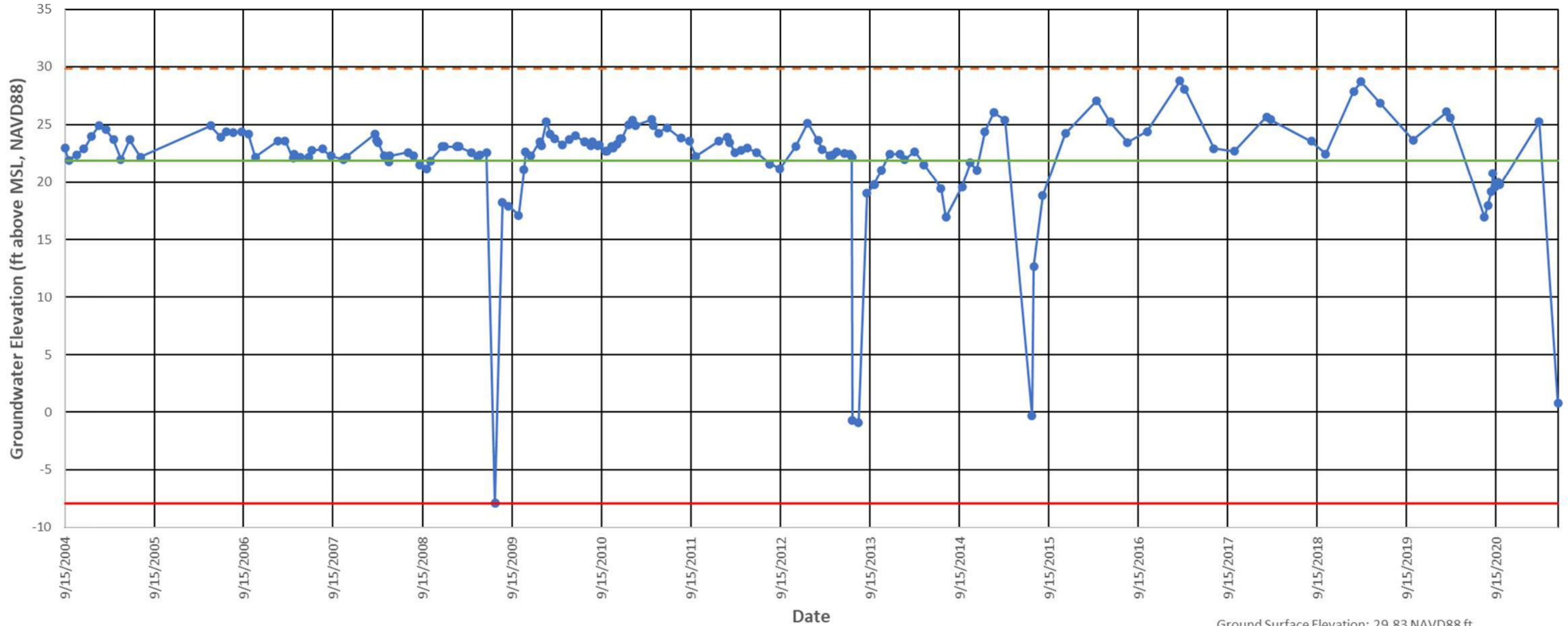

- Groundwater Level
- - - Ground Surface Elevation
- Measurable Objective
- Minimum Threshold

Operational Range: 29.79 ft
 MT Method Selected: Historic Low

Site Code: 389605N1218102W002
 SWN: 13N01E24G003M
 Local ID: Flood MW-1B (int)
 Other ID: N/A

Ground Surface Elevation: 29.83 NAVD88 ft
 Depth: 160 ft bgs
 Screen Interval - 1: 130 - 160 ft bgs
 Screen Interval - 2: N/A - N/A ft bgs
 Aquifer Zone: AZ-2

Hillcrest Well #8

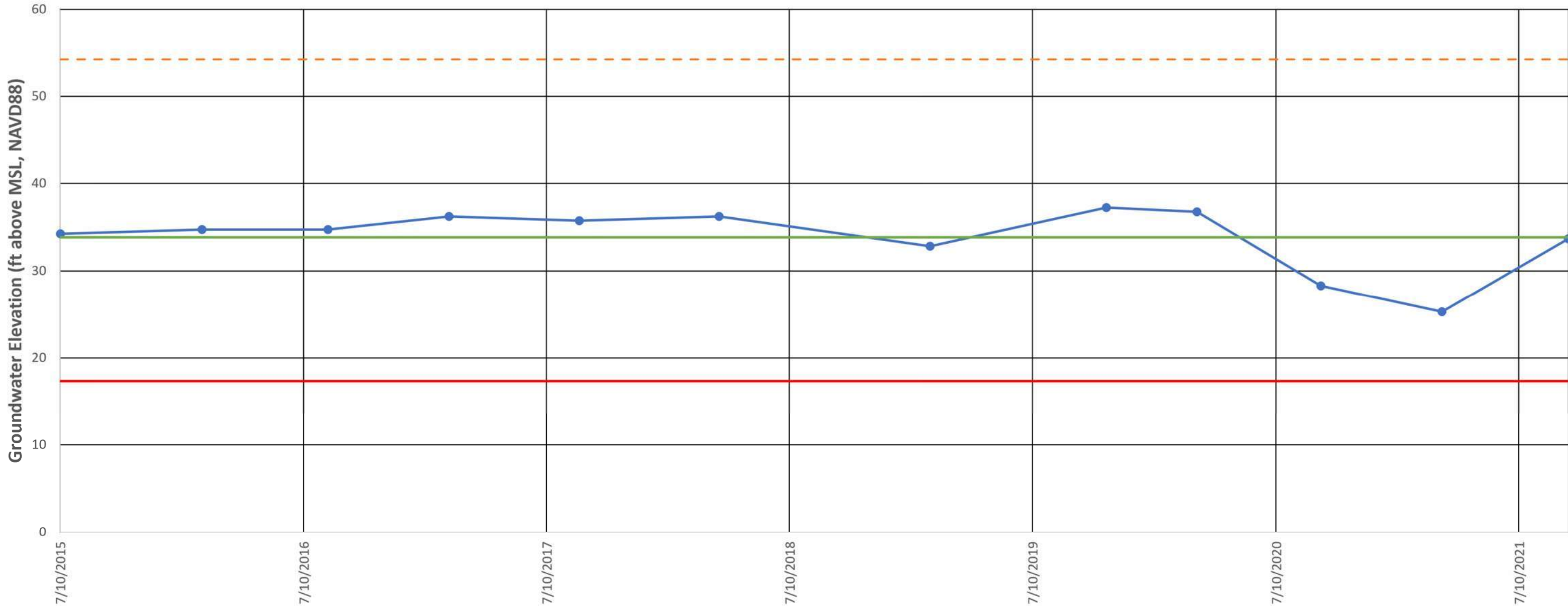

- Groundwater Level
- - - Ground Surface Elevation
- Measurable Objective
- Minimum Threshold

Operational Range: 16.5 ft
 MT Method Selected: Minimum Operating Range

Site Code: N/A
 SWN: N/A
 Local ID: Hillcrest Well #8
 Other ID: N/A

Ground Surface Elevation: 54.247 NAVD88 ft
 Depth: 254 ft bgs
 Screen Interval - 1: N/A - N/A ft bgs
 Screen Interval - 2: N/A - N/A ft bgs
 Aquifer Zone: AZ-2

Hillcrest Well #9

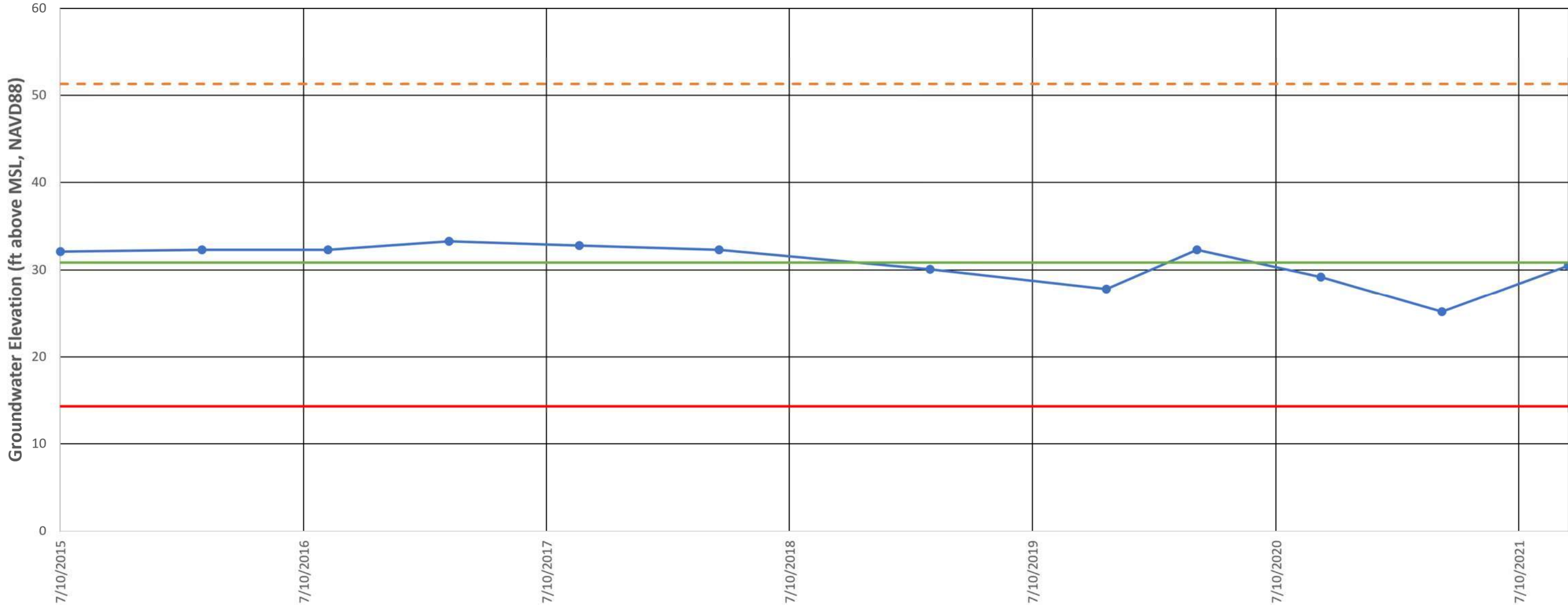

- Groundwater Level
- Ground Surface Elevation
- Measurable Objective
- Minimum Threshold

Operational Range: 16.5 ft
MT Method Selected: Minimum Operating Range

Site Code: N/A
SWN: N/A
Local ID: Hillcrest Well #9
Other ID: N/A

Ground Surface Elevation: 51.301 NAVD88 ft
Depth: 190 ft bgs
Screen Interval - 1: N/A - N/A ft bgs
Screen Interval - 2: N/A - N/A ft bgs
Aquifer Zone: AZ-2

SEWD MW-1A

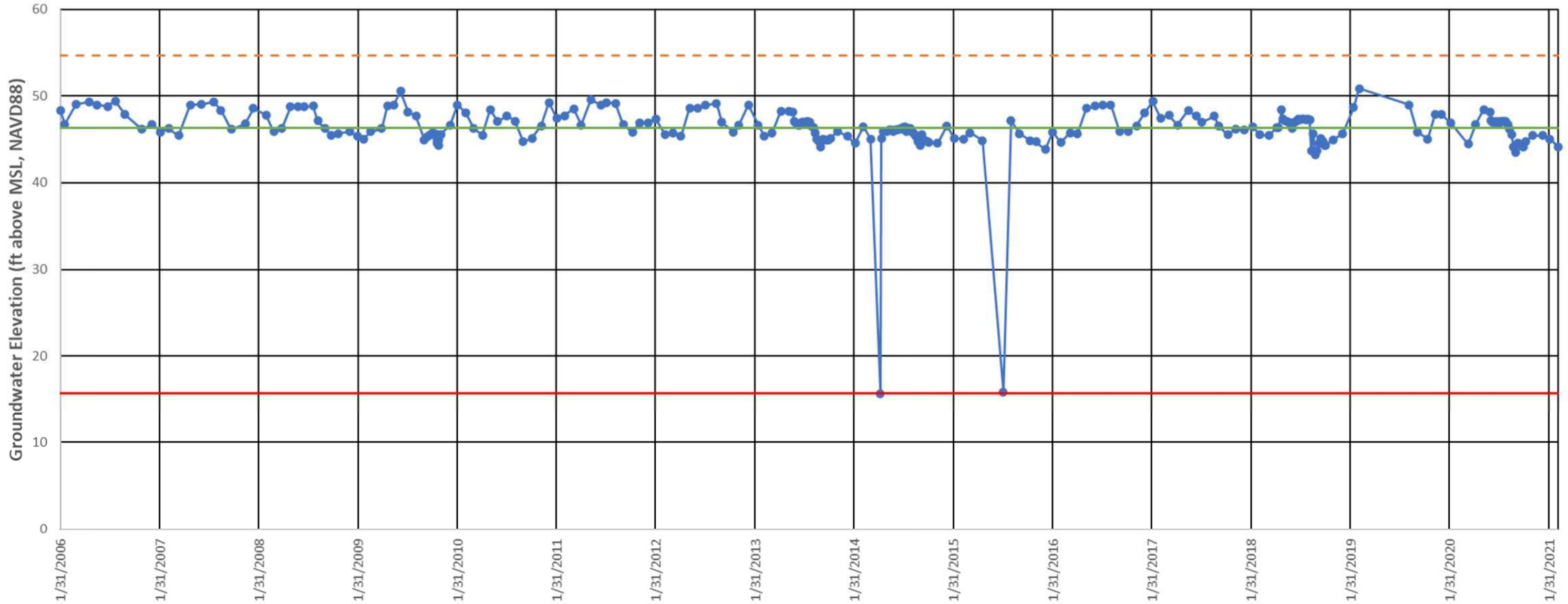

Date

- Groundwater Level
- - - Ground Surface Elevation
- Measurable Objective
- Minimum Threshold

Operational Range: 30.62 ft
 MT Method Selected: Historic Low

Site Code: 391658N1217070W001
 SWN: 15N02E12E001M
 Local ID: SEWD MW-1A
 Other ID: N/A

Ground Surface Elevation: 54.66 NAVD88 ft
 Depth: 173 ft bgs
 Screen Interval - 1: 148 - 168 ft bgs
 Screen Interval - 2: N/A - N/A ft bgs
 Aquifer Zone: AZ-2

SEWD MW-1B

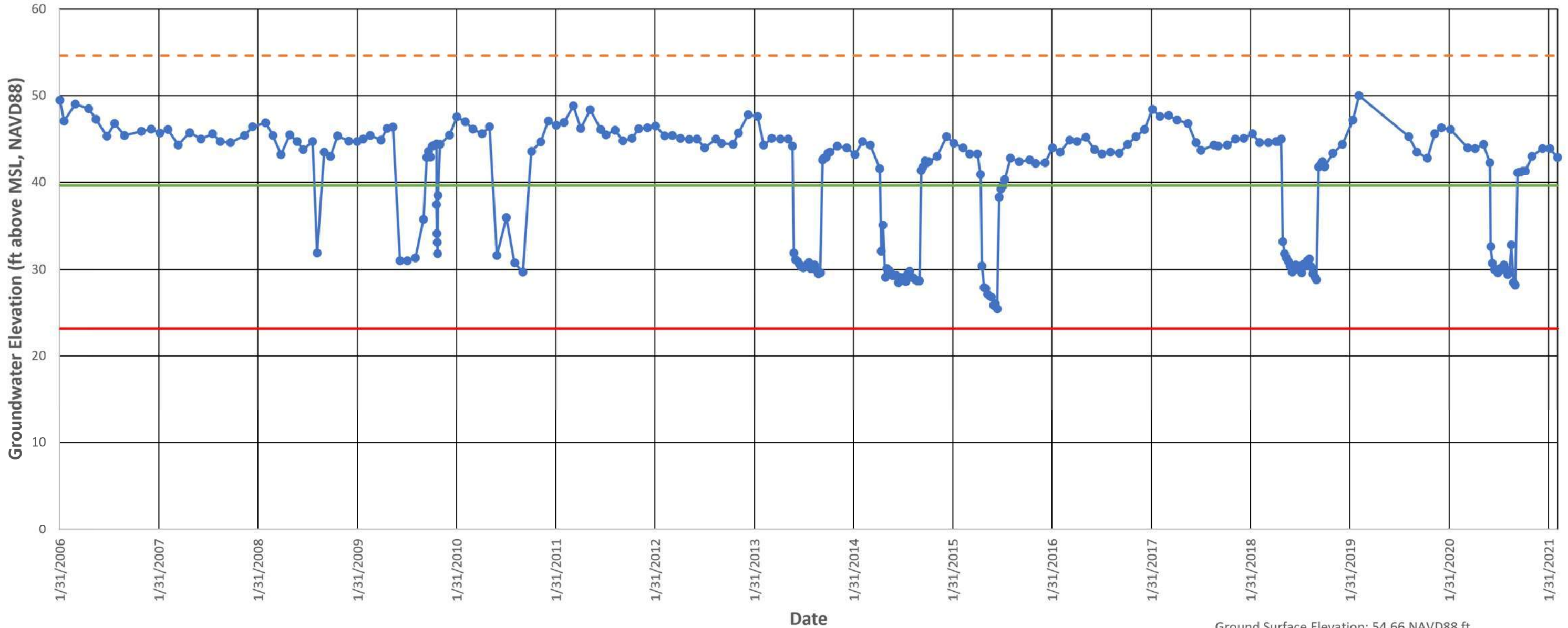

- Groundwater Level
- - - Ground Surface Elevation
- Measurable Objective
- Minimum Threshold

Operational Range: 16.5 ft
 MT Method Selected: Minimum Operating Range

Site Code: 391658N1217070W002
 SWN: 15N02E12E002M
 Local ID: SEWD MW-1B
 Other ID: N/A

Ground Surface Elevation: 54.66 NAVD88 ft
 Depth: 266 ft bgs
 Screen Interval - 1: 240 - 260 ft bgs
 Screen Interval - 2: N/A - N/A ft bgs
 Aquifer Zone: AZ-2

SEWD MW-2A

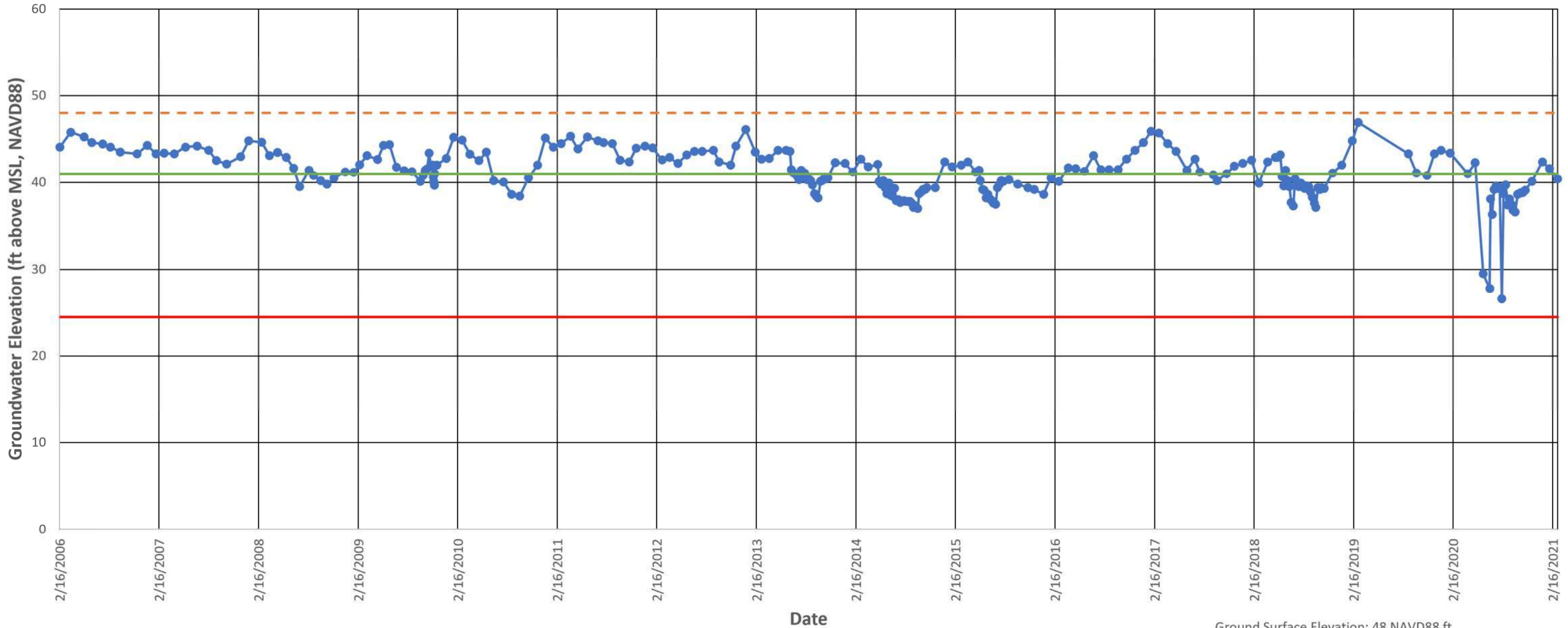

- Groundwater Level
- - - Ground Surface Elevation
- Measurable Objective
- Minimum Threshold

Operational Range: 16.5 ft
 MT Method Selected: Minimum Operating Range

Site Code: 391279N1216989W001
 SWN: 15N02E24P001M
 Local ID: SEWD MW-2A
 Other ID: N/A

Ground Surface Elevation: 48 NAVD88 ft
 Depth: 254 ft bgs
 Screen Interval - 1: 204 - 244 ft bgs
 Screen Interval - 2: N/A - N/A ft bgs
 Aquifer Zone: AZ-2

SEWD MW-2B

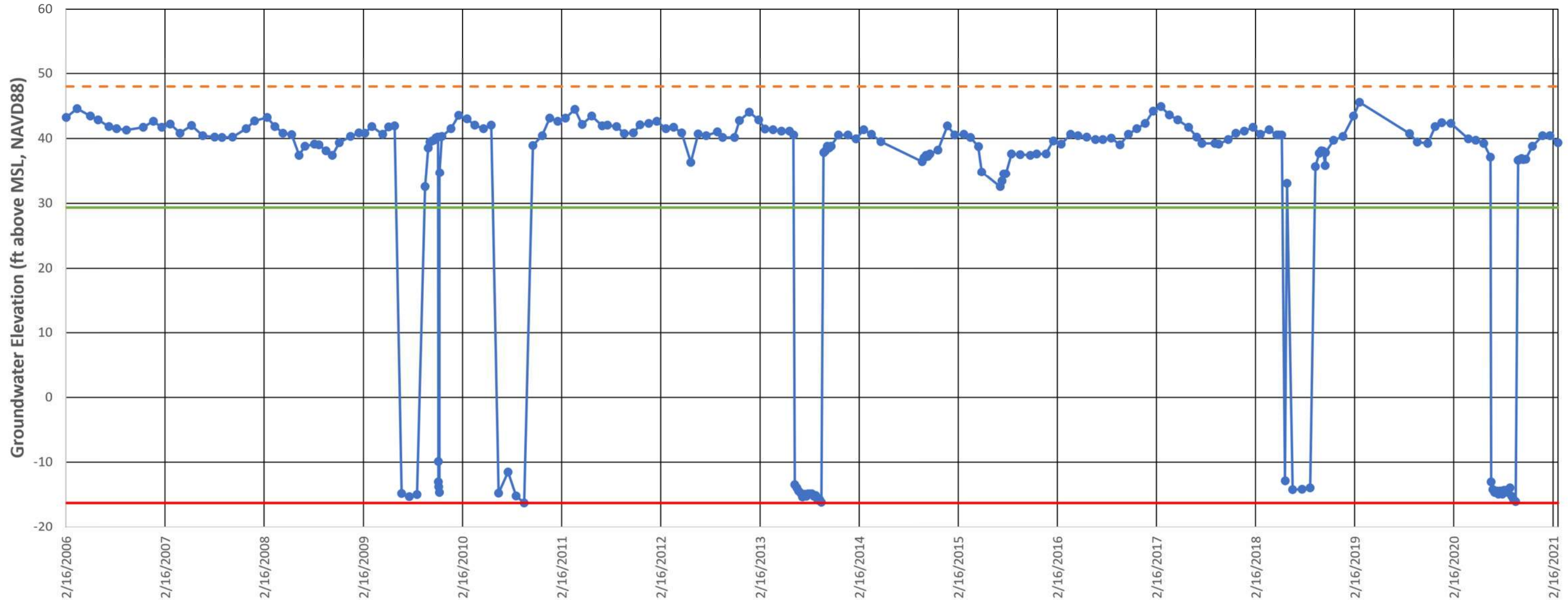

- Groundwater Level
- - - Ground Surface Elevation
- Measurable Objective
- Minimum Threshold

Operational Range: 45.61 ft
 MT Method Selected: Historic Low

Site Code: 391279N1216989W002
 SWN: 15N02E24P002M
 Local ID: SEWD MW-2B
 Other ID: N/A

Ground Surface Elevation: 48 NAVD88 ft
 Depth: 379 ft bgs
 Screen Interval - 1: 354 - 374 ft bgs
 Screen Interval - 2: N/A - N/A ft bgs
 Aquifer Zone: AZ-2

SEWD MW-3B

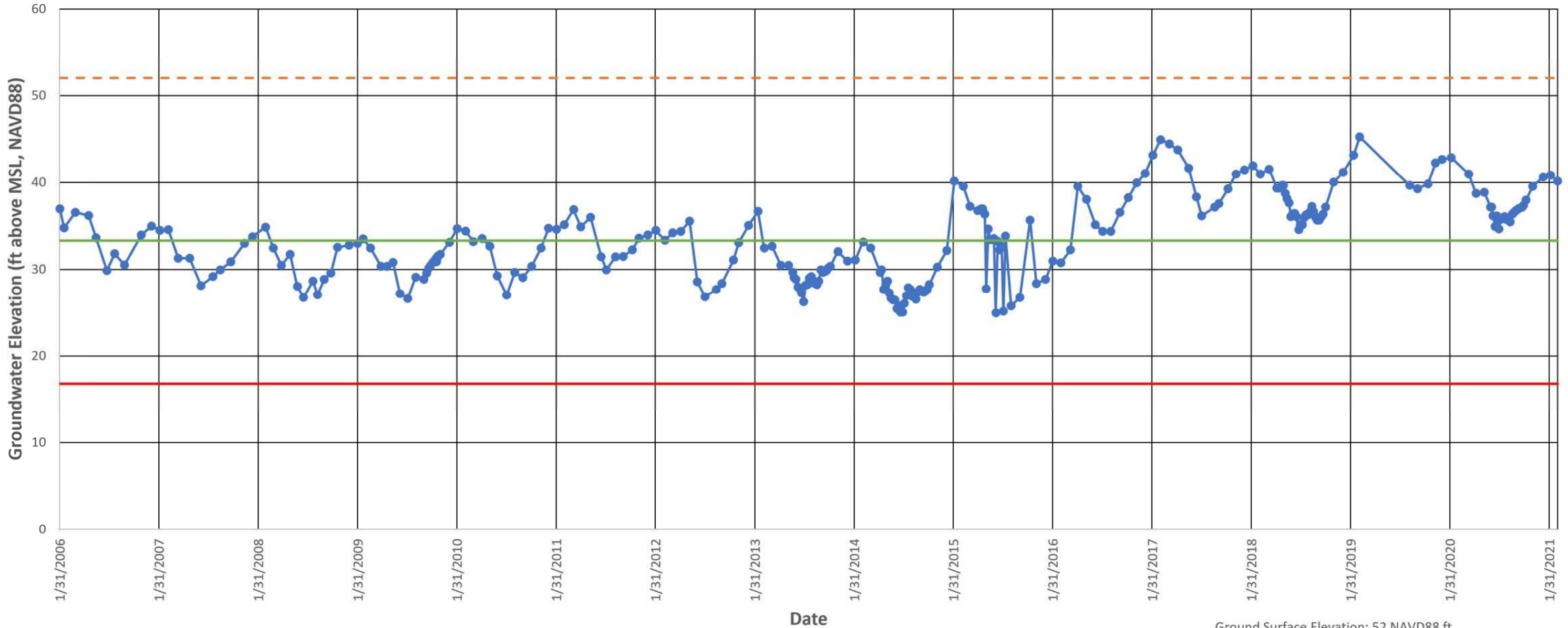

- Groundwater Level
- - - Ground Surface Elevation
- Measurable Objective
- Minimum Threshold

Operational Range: 16.5 ft
 MT Method Selected: Minimum Operating Range

Site Code: 390682N1216901W002
 SWN: 14N02E13A004M
 Local ID: SEWD MW-3B
 Other ID: N/A

Ground Surface Elevation: 52 NAVD88 ft
 Depth: 245 ft bgs
 Screen Interval - 1: 210 - 240 ft bgs
 Screen Interval - 2: N/A - N/A ft bgs
 Aquifer Zone: AZ-2

SMWC MW-1B

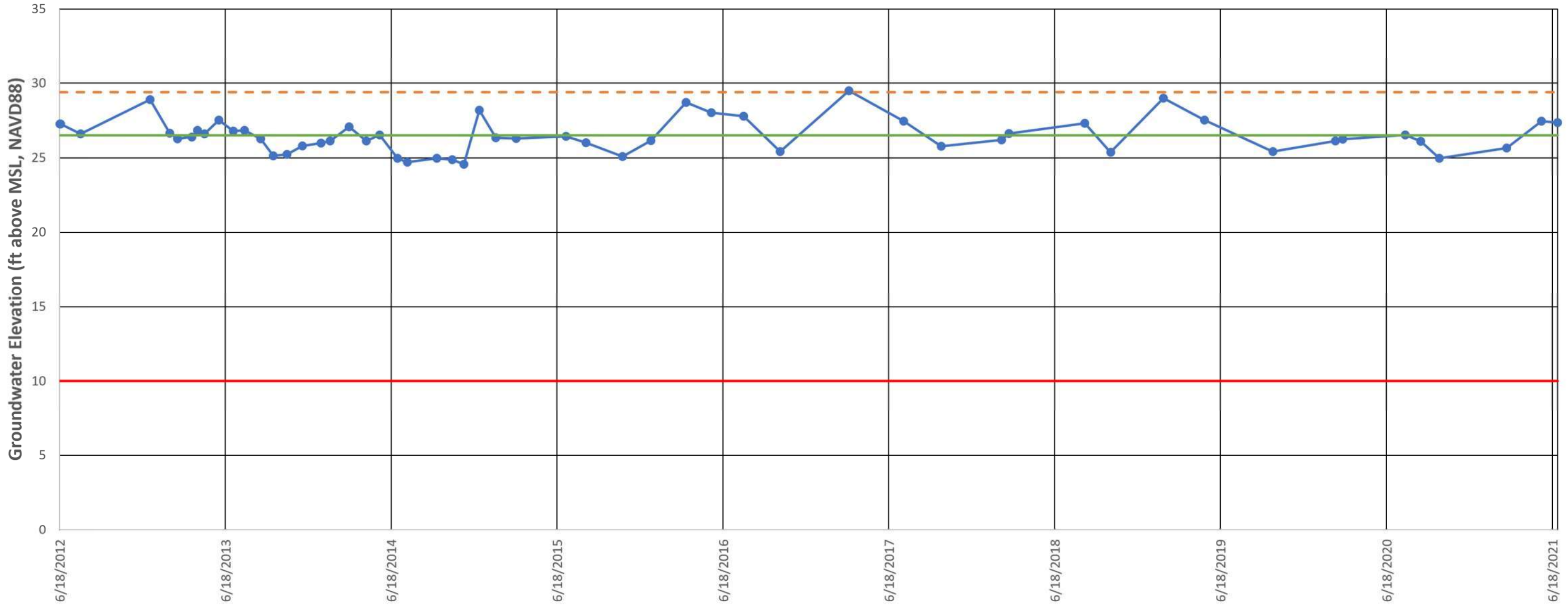

- Groundwater Level
- - - Ground Surface Elevation
- Measurable Objective
- Minimum Threshold

Operational Range: 16.5 ft
 MT Method Selected: Minimum Operating Range

Site Code: 390244N1217813W002
 SWN: 14N02E32D002M
 Local ID: SMWC MW-1B
 Other ID: N/A

Ground Surface Elevation: 29.4 NAVD88 ft
 Depth: 210 ft bgs
 Screen Interval - 1: 170 - 200 ft bgs
 Screen Interval - 2: N/A - N/A ft bgs
 Aquifer Zone: AZ-2

Sutter County MW-1B

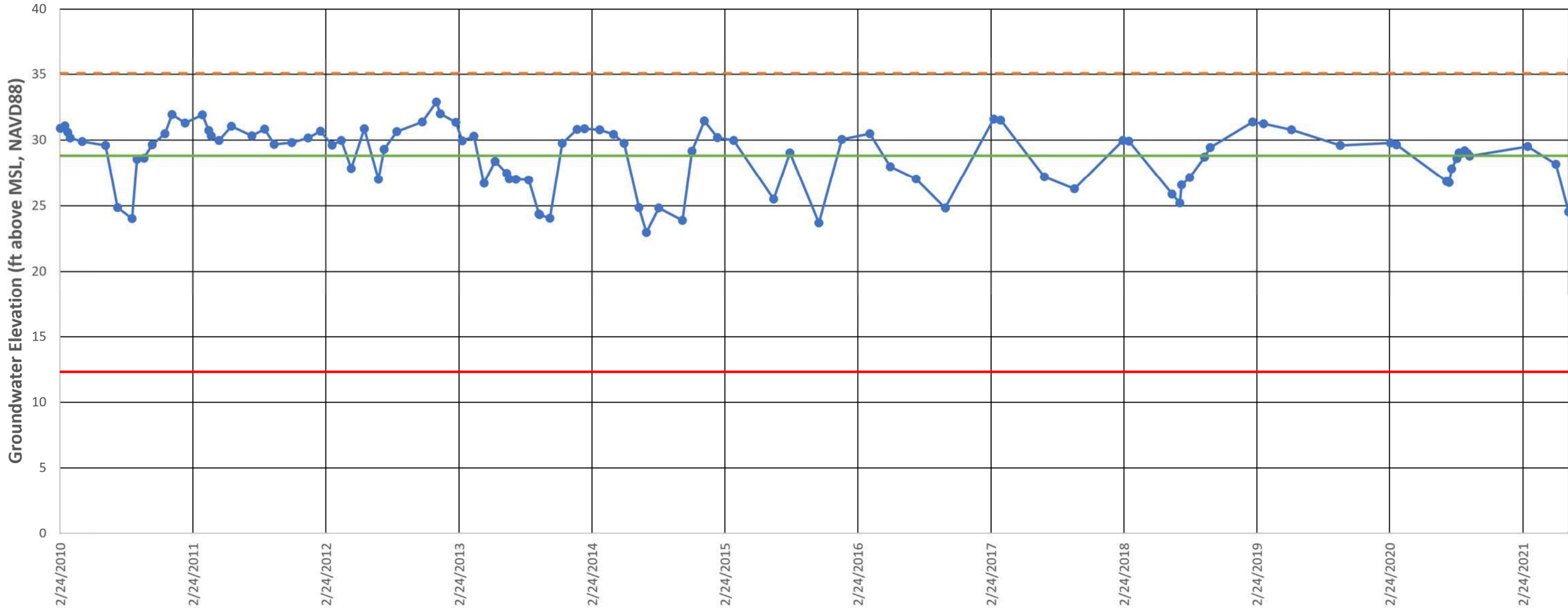

- Groundwater Level
- - - Ground Surface Elevation
- Measurable Objective
- Minimum Threshold

Operational Range: 16.5 ft
 MT Method Selected: Minimum Operating Range

Site Code: 390696N1217778W002
 SWN: 14N02E17C002M
 Local ID: Sutter County MW-1B
 Other ID: N/A

Ground Surface Elevation: 35.079 NAVD88 ft
 Depth: 245 ft bgs
 Screen Interval - 1: 205 - 215 ft bgs
 Screen Interval - 2: 225 - 235 ft bgs
 Aquifer Zone: AZ-2

Sutter County MW-2B

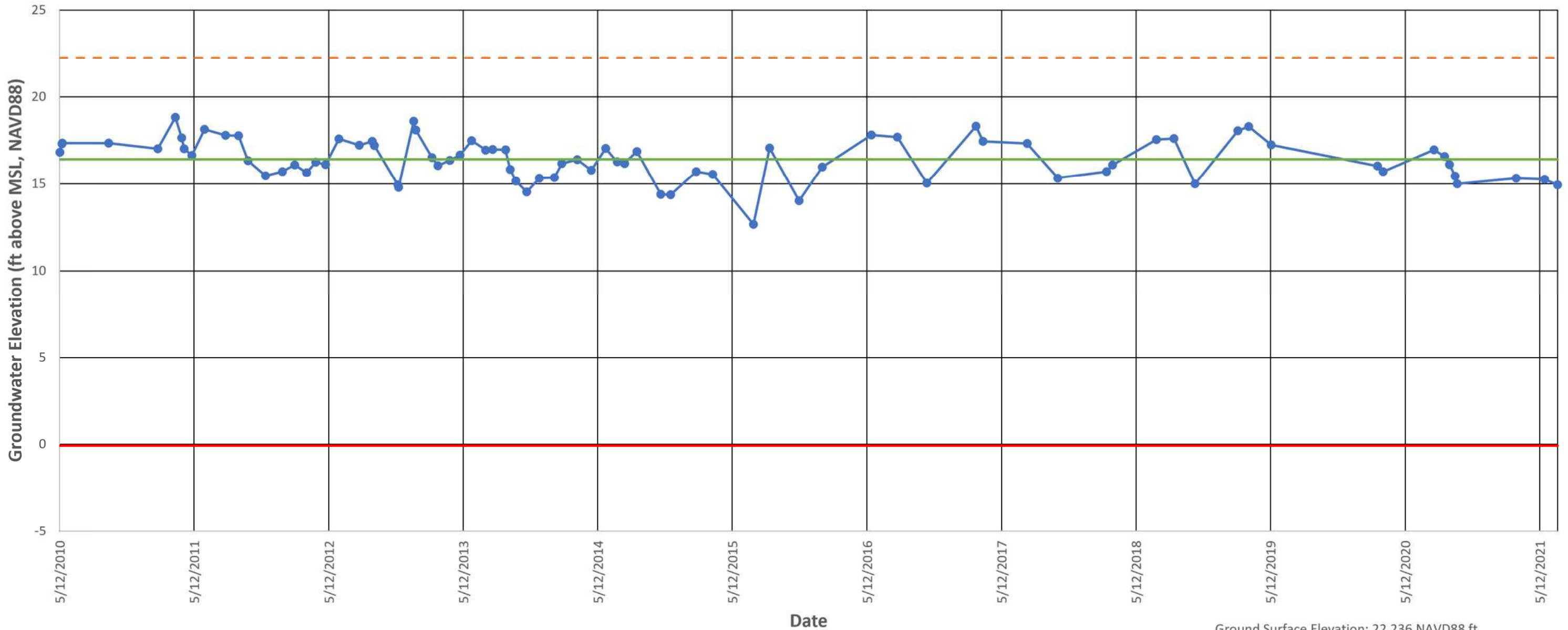

- Groundwater Level
- - - Ground Surface Elevation
- Measurable Objective
- Minimum Threshold

Operational Range: 16.5 ft
 MT Method Selected: Minimum Operating Range

Site Code: 388761N1217094W002
 SWN: 11N03E20H003M
 Local ID: Sutter County MW-2B
 Other ID: N/A

Ground Surface Elevation: 22.236 NAVD88 ft
 Depth: 300 ft bgs
 Screen Interval - 1: 210 - 220 ft bgs
 Screen Interval - 2: 260 - 280 ft bgs
 Aquifer Zone: AZ-2

Sutter County MW-3B

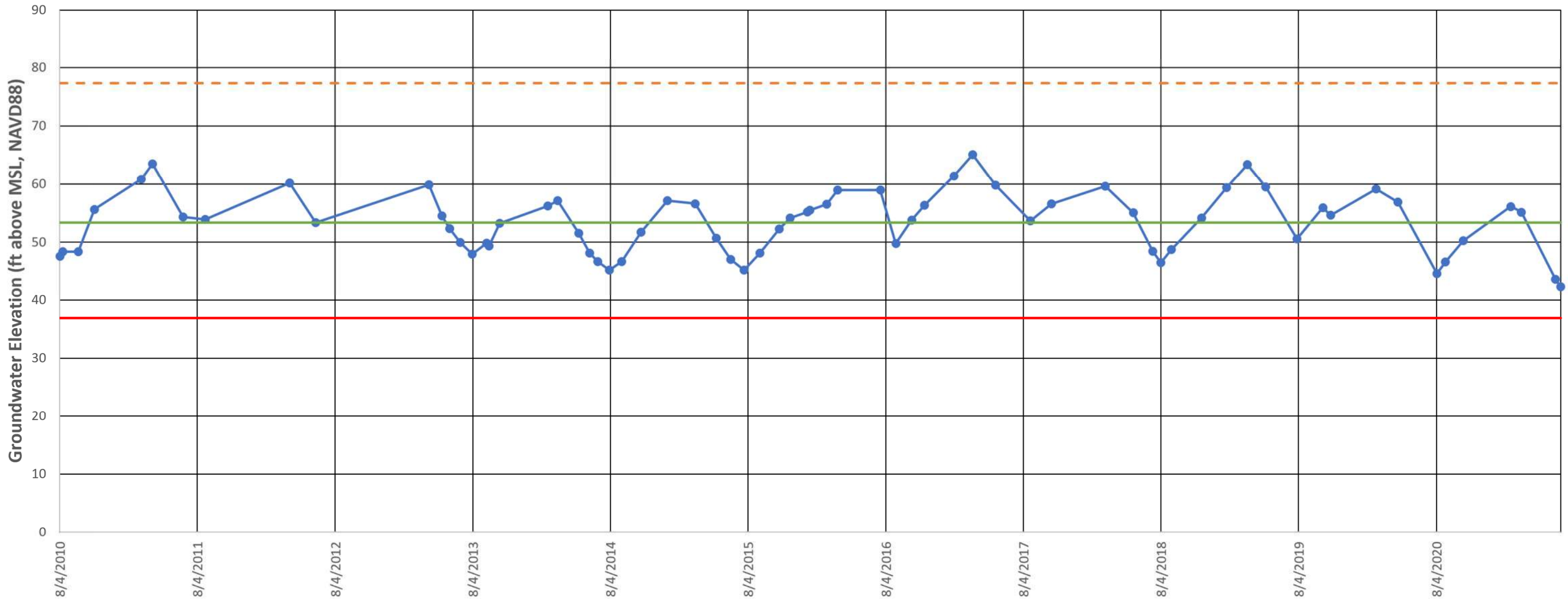

- Groundwater Level
- - - Ground Surface Elevation
- Measurable Objective
- Minimum Threshold

Operational Range: 16.5 ft
 MT Method Selected: Minimum Operating Range

Site Code: 392394N1216509W002
 SWN: 16N03E17J002M
 Local ID: Sutter County MW-3B
 Other ID: N/A

Ground Surface Elevation: 77.35 NAVD88 ft
 Depth: 315 ft bgs
 Screen Interval - 1: 285 - 305 ft bgs
 Screen Interval - 2: N/A - N/A ft bgs
 Aquifer Zone: AZ-2

Sutter County MW-4A

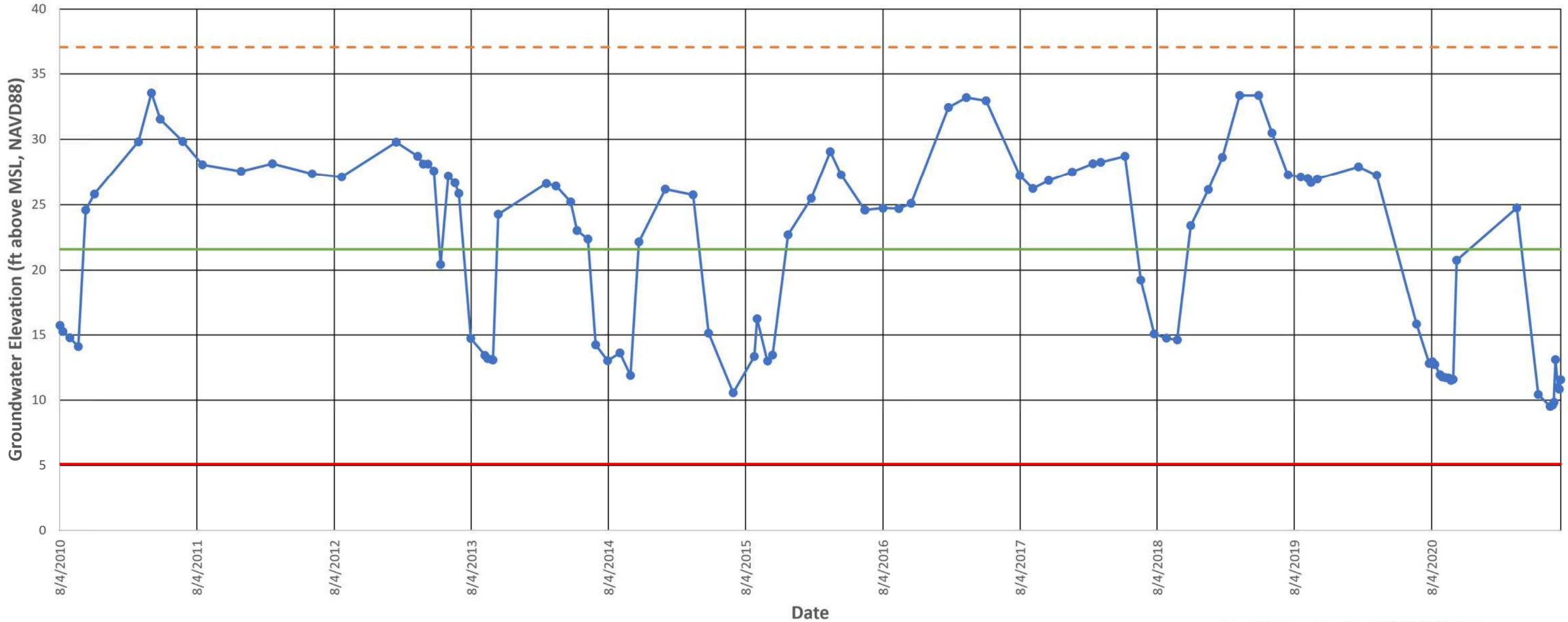

- Groundwater Level
- - - Ground Surface Elevation
- Measurable Objective
- Minimum Threshold

Operational Range: 16.5 ft
 MT Method Selected: Minimum Operating Range

Site Code: 389452N1215992W001
 SWN: 13N03E26J002M
 Local ID: Sutter County MW-4A
 Other ID: N/A

Ground Surface Elevation: 37.081 NAVD88 ft
 Depth: 175 ft bgs
 Screen Interval - 1: 145 - 165 ft bgs
 Screen Interval - 2: N/A - N/A ft bgs
 Aquifer Zone: AZ-2

Sutter County MW-6B

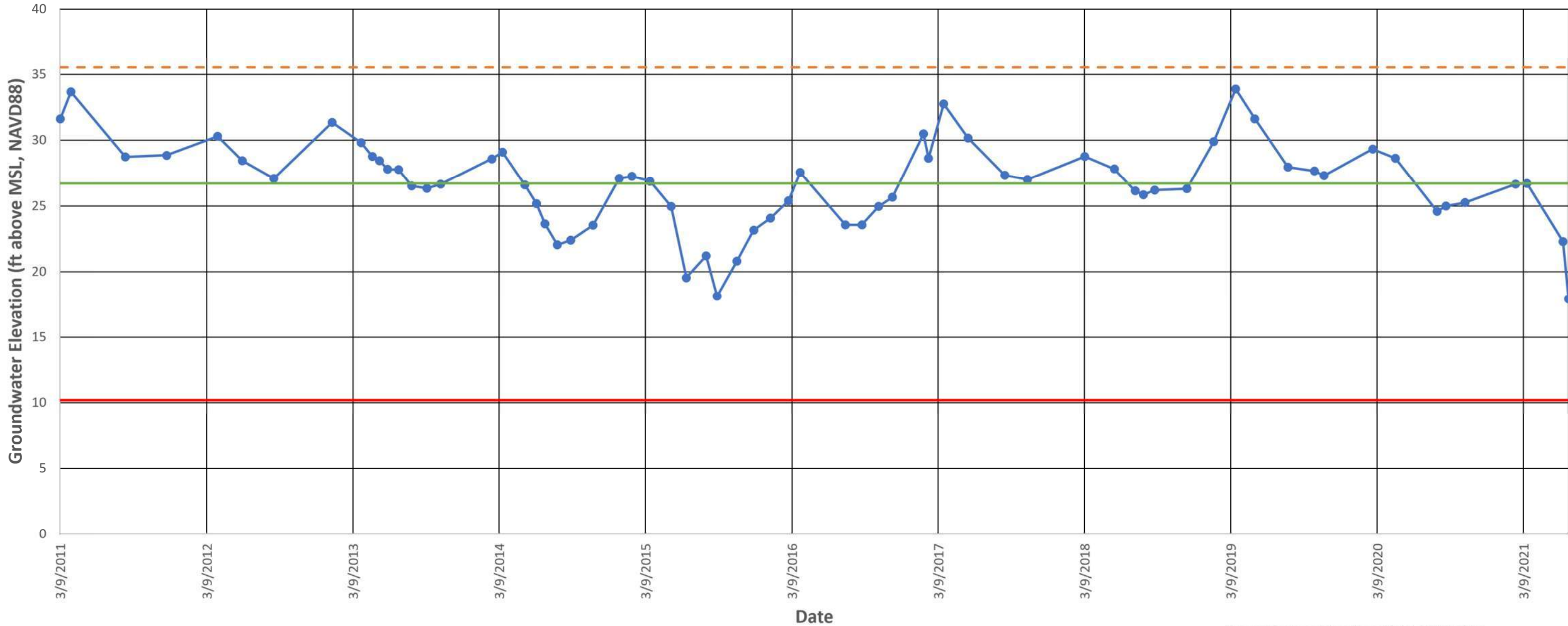

- Groundwater Level
- - - Ground Surface Elevation
- Measurable Objective
- Minimum Threshold

Operational Range: 16.5 ft
 MT Method Selected: Minimum Operating Range

Site Code: 390087N1216722W002
 SWN: 13N03E06A002M
 Local ID: Sutter County MW-6B
 Other ID: N/A

Ground Surface Elevation: 35.55 NAVD88 ft
 Depth: 175 ft bgs
 Screen Interval - 1: 155 - 165 ft bgs
 Screen Interval - 2: N/A - N/A ft bgs
 Aquifer Zone: AZ-2

Sutter County MW-6C

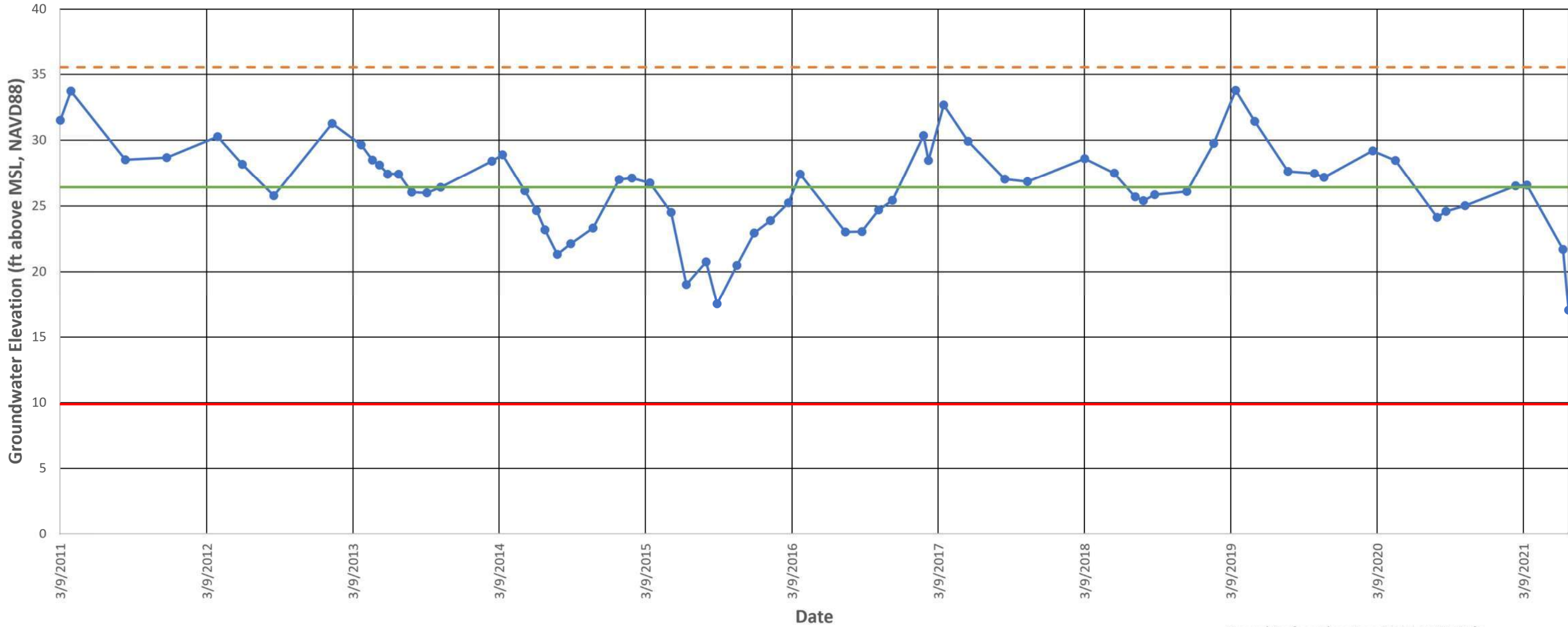

- Groundwater Level
- - - Ground Surface Elevation
- Measurable Objective
- Minimum Threshold

Operational Range: 16.5 ft
 MT Method Selected: Minimum Operating Range

Site Code: 390087N1216722W003
 SWN: 13N03E06A003M
 Local ID: Sutter County MW-6C
 Other ID: N/A

Ground Surface Elevation: 35.55 NAVD88 ft
 Depth: 265 ft bgs
 Screen Interval - 1: 245 - 255 ft bgs
 Screen Interval - 2: N/A - N/A ft bgs
 Aquifer Zone: AZ-2

WTP well

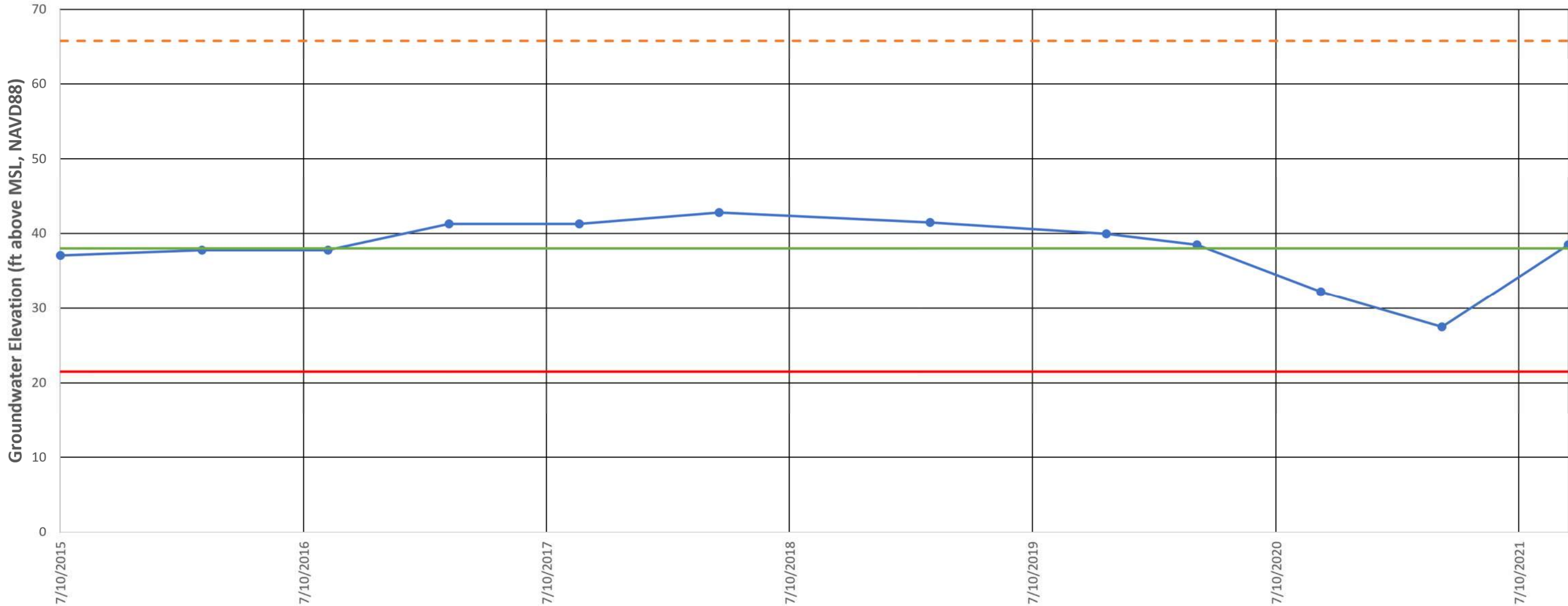

- Groundwater Level
- Ground Surface Elevation
- Measurable Objective
- Minimum Threshold

Operational Range: 16.5 ft
MT Method Selected: Minimum Operating Range

Site Code: N/A
SWN: N/A
Local ID: WTP well
Other ID: N/A

Ground Surface Elevation: 65.785 NAVD88 ft
Depth: 0 ft bgs
Screen Interval - 1: 370 - 390 ft bgs
Screen Interval - 2: 453 - 473 ft bgs
Aquifer Zone: AZ-2 and AZ-3

17N02E31A001M

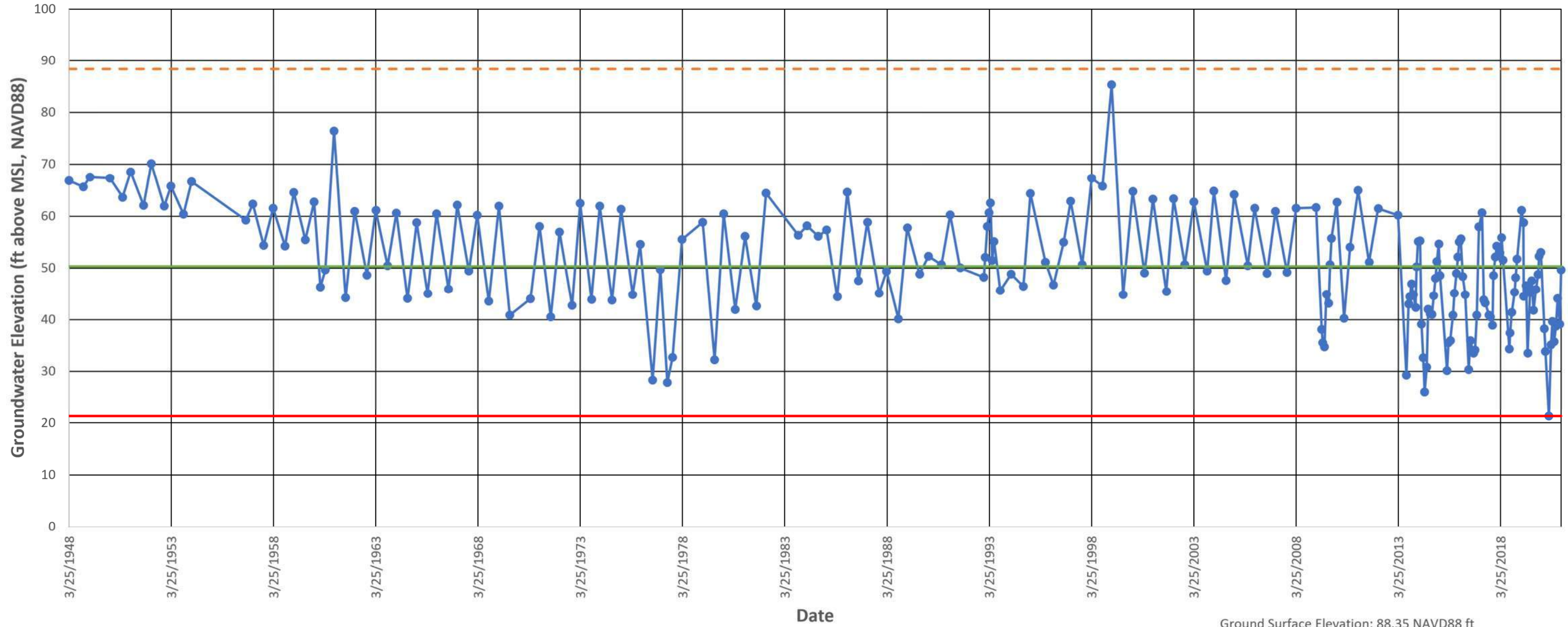

- Groundwater Level
- Ground Surface Elevation
- Measurable Objective
- Minimum Threshold

Operational Range: 29 ft
MT Method Selected: Historic Low

Site Code: 392867N1217825W001
SWN: 17N02E31A001M
Local ID: N/A
Other ID: N/A

Ground Surface Elevation: 88.35 NAVD88 ft
Depth: 540 ft bgs
Screen Interval - 1: N/A - N/A ft bgs
Screen Interval - 2: N/A - N/A ft bgs
Aquifer Zone: AZ-3

BWD MW-1A

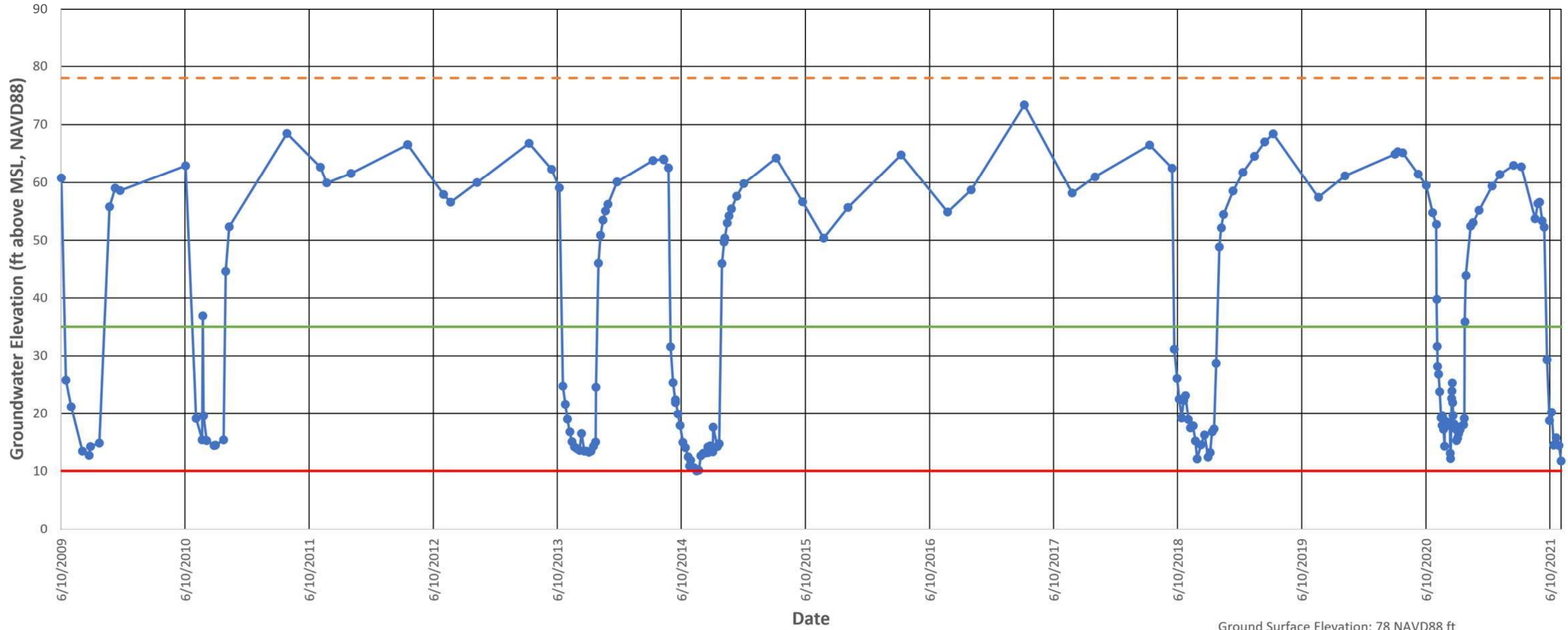

- Groundwater Level
- - - Ground Surface Elevation
- Measurable Objective
- Minimum Threshold

Operational Range: 24.91 ft
 MT Method Selected: Historic Low

Site Code: 392970N1216907W001
 SWN: 17N02E25J001M
 Local ID: BWD MW-1A
 Other ID: N/A

Ground Surface Elevation: 78 NAVD88 ft
 Depth: 591 ft bgs
 Screen Interval - 1: 486 - 586 ft bgs
 Screen Interval - 2: N/A - N/A ft bgs
 Aquifer Zone: AZ-3

Feather River MW-1C

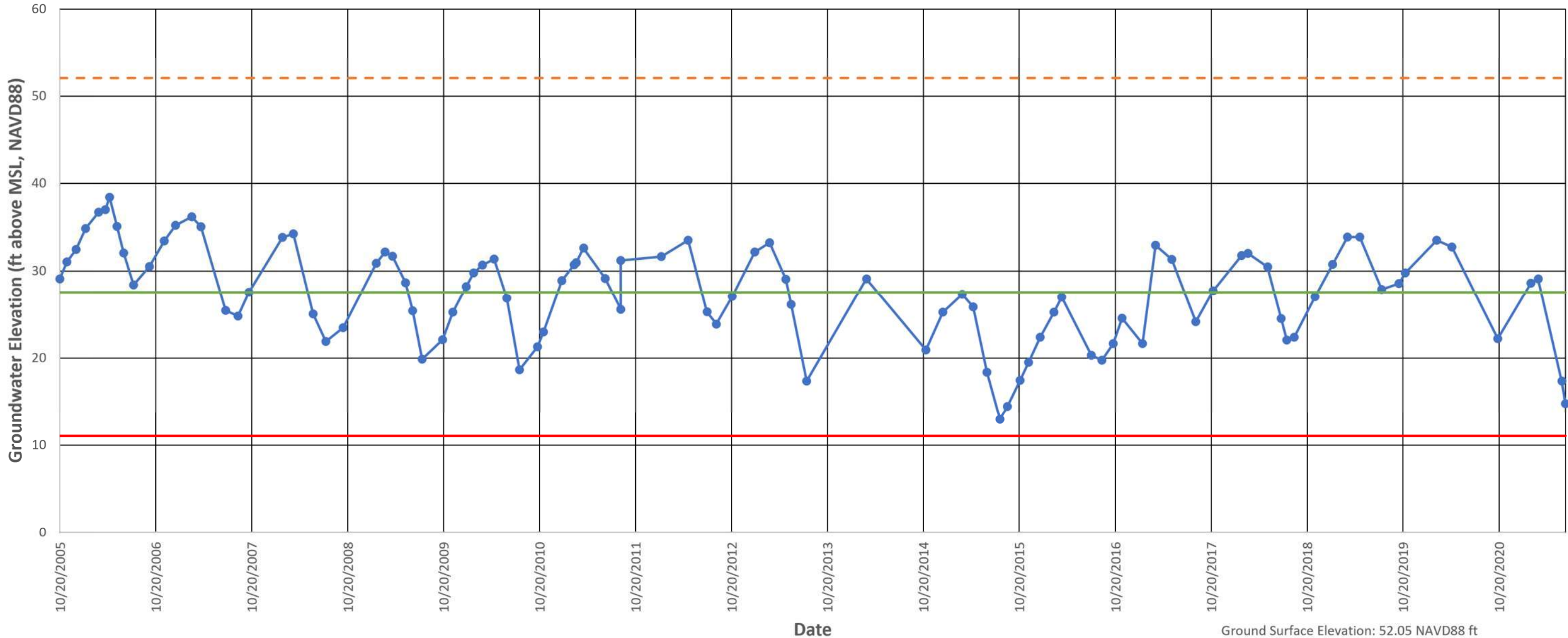

- Groundwater Level
- - - Ground Surface Elevation
- Measurable Objective
- Minimum Threshold

Operational Range: 16.5 ft
 MT Method Selected: Minimum Operating Range

Site Code: 390458N1216114W003
 SWN: 14N03E23D005M
 Local ID: Feather River MW-1C
 Other ID: N/A

Ground Surface Elevation: 52.05 NAVD88 ft
 Depth: 689 ft bgs
 Screen Interval - 1: 664 - 684 ft bgs
 Screen Interval - 2: N/A - N/A ft bgs
 Aquifer Zone: AZ-3

Feather River MW-1D

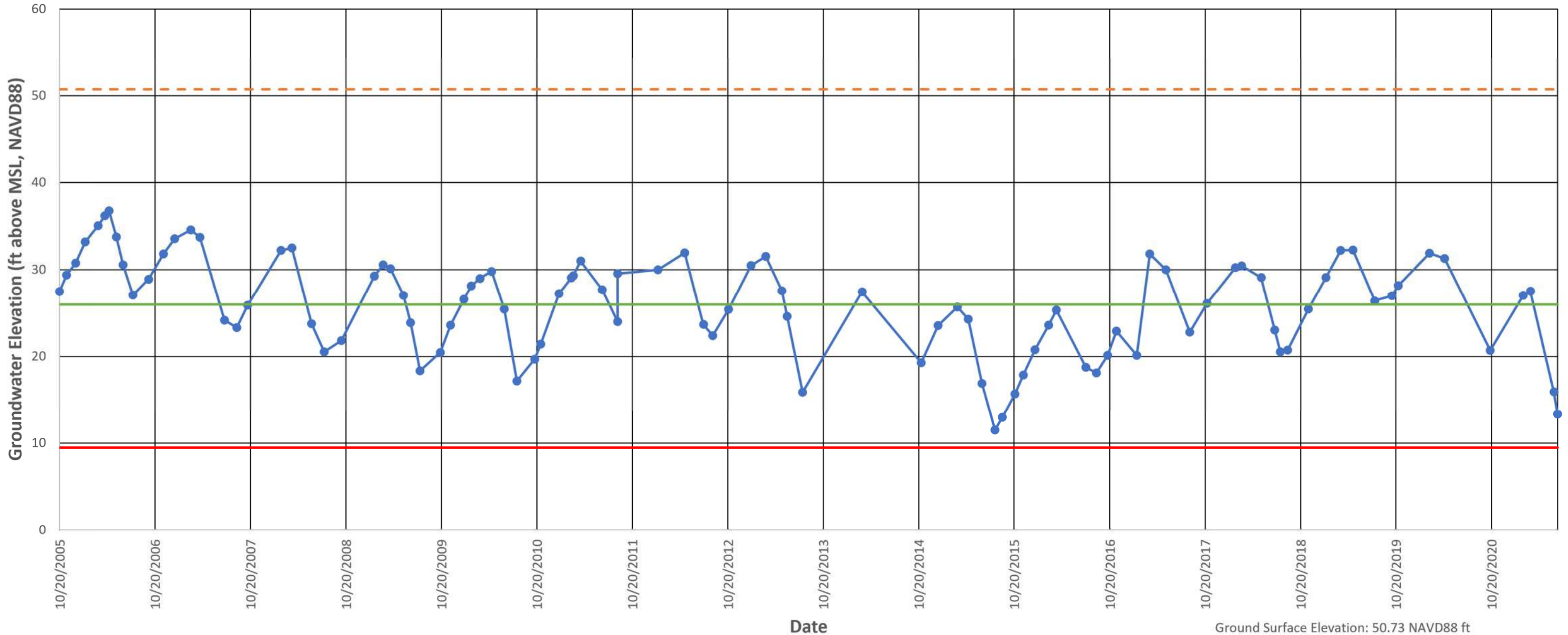

- Groundwater Level
- - - Ground Surface Elevation
- Measurable Objective
- Minimum Threshold

Operational Range: 16.5 ft
 MT Method Selected: Minimum Operating Range

Site Code: 390458N1216114W004
 SWN: 14N03E23D006M
 Local ID: Feather River MW-1D
 Other ID: N/A

Ground Surface Elevation: 50.73 NAVD88 ft
 Depth: 1021 ft bgs
 Screen Interval - 1: 996 - 1016 ft bgs
 Screen Interval - 2: N/A - N/A ft bgs
 Aquifer Zone: AZ-3

SEWD MW-1C

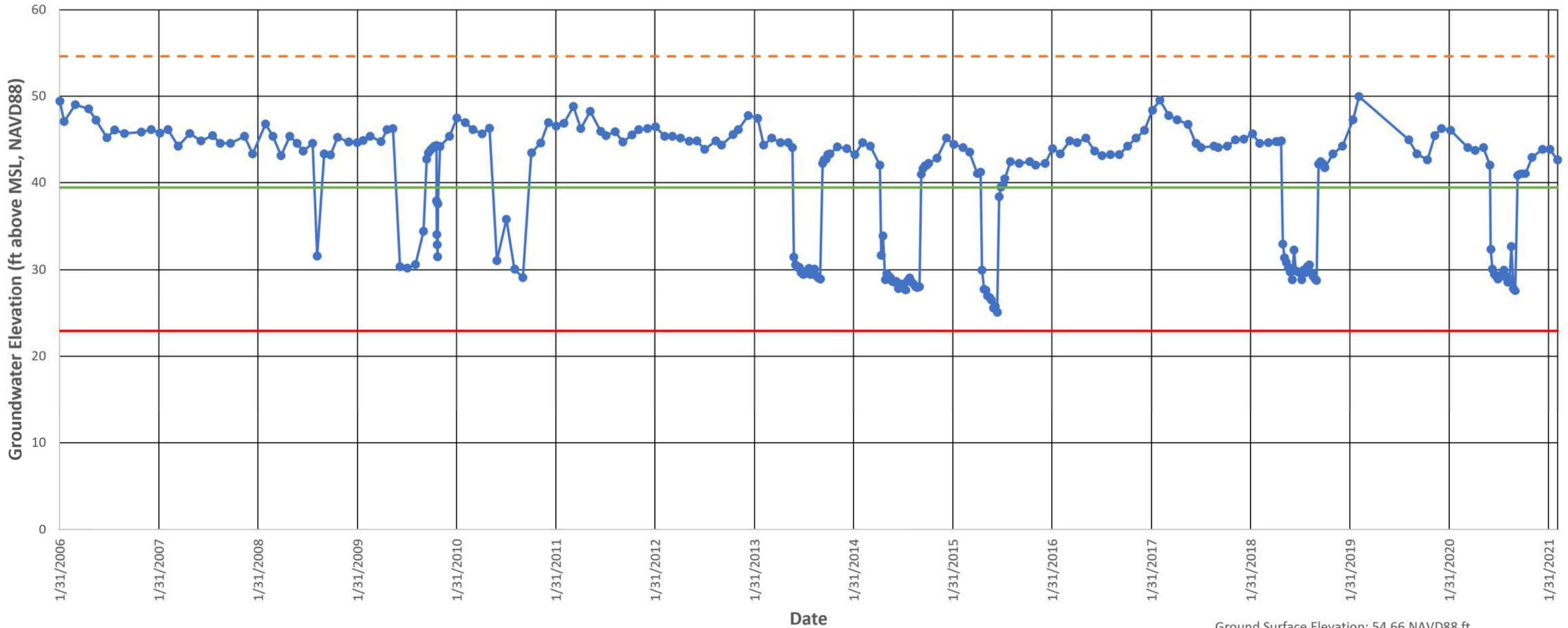

- Groundwater Level
- - - Ground Surface Elevation
- Measurable Objective
- Minimum Threshold

Operational Range: 16.5 ft
 MT Method Selected: Minimum Operating Range

Site Code: 391658N1217070W003
 SWN: 15N02E12E003M
 Local ID: SEWD MW-1C
 Other ID: N/A

Ground Surface Elevation: 54.66 NAVD88 ft
 Depth: 559 ft bgs
 Screen Interval - 1: 524 - 554 ft bgs
 Screen Interval - 2: N/A - N/A ft bgs
 Aquifer Zone: AZ-3

SEWD MW-2C

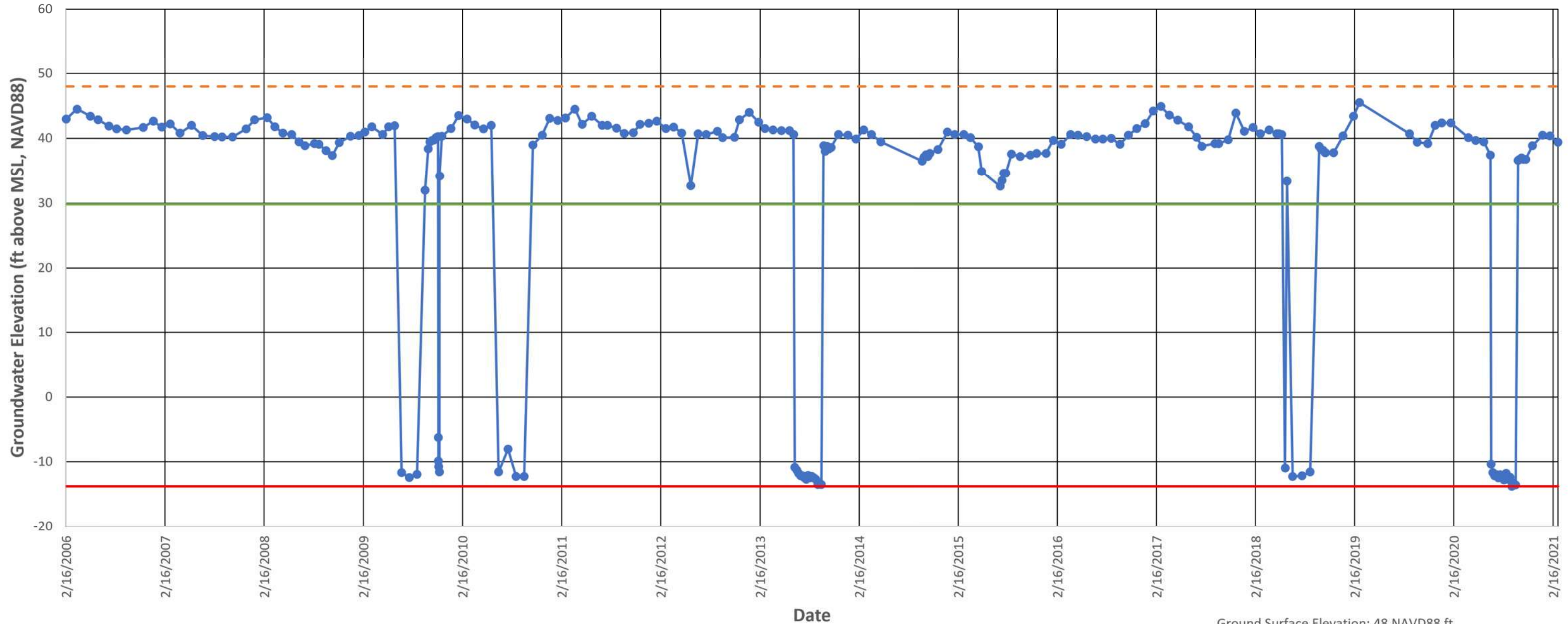

- Groundwater Level
- - - Ground Surface Elevation
- Measurable Objective
- Minimum Threshold

Operational Range: 43.6 ft
 MT Method Selected: Historic Low

Site Code: 391279N1216989W003
 SWN: 15N02E24P003M
 Local ID: SEWD MW-2C
 Other ID: N/A

Ground Surface Elevation: 48 NAVD88 ft
 Depth: 488 ft bgs
 Screen Interval - 1: 438 - 478 ft bgs
 Screen Interval - 2: N/A - N/A ft bgs
 Aquifer Zone: AZ-3

SEWD MW-3C

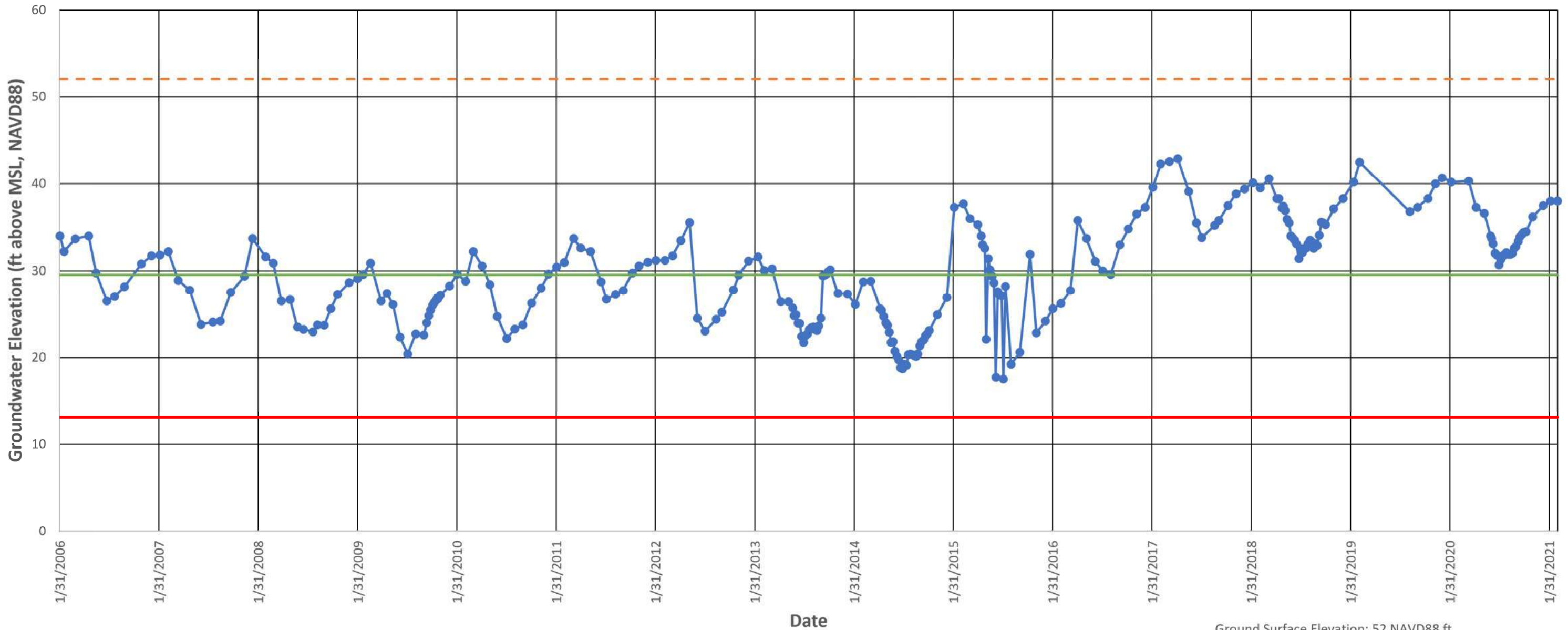

- Groundwater Level
- - - Ground Surface Elevation
- Measurable Objective
- Minimum Threshold

Operational Range: 16.5 ft
 MT Method Selected: Minimum Operating Range

Site Code: 390682N1216901W003
 SWN: 14N02E13A005M
 Local ID: SEWD MW-3C
 Other ID: N/A

Ground Surface Elevation: 52 NAVD88 ft
 Depth: 585 ft bgs
 Screen Interval - 1: 550 - 580 ft bgs
 Screen Interval - 2: N/A - N/A ft bgs
 Aquifer Zone: AZ-3

SMWC MW-1C

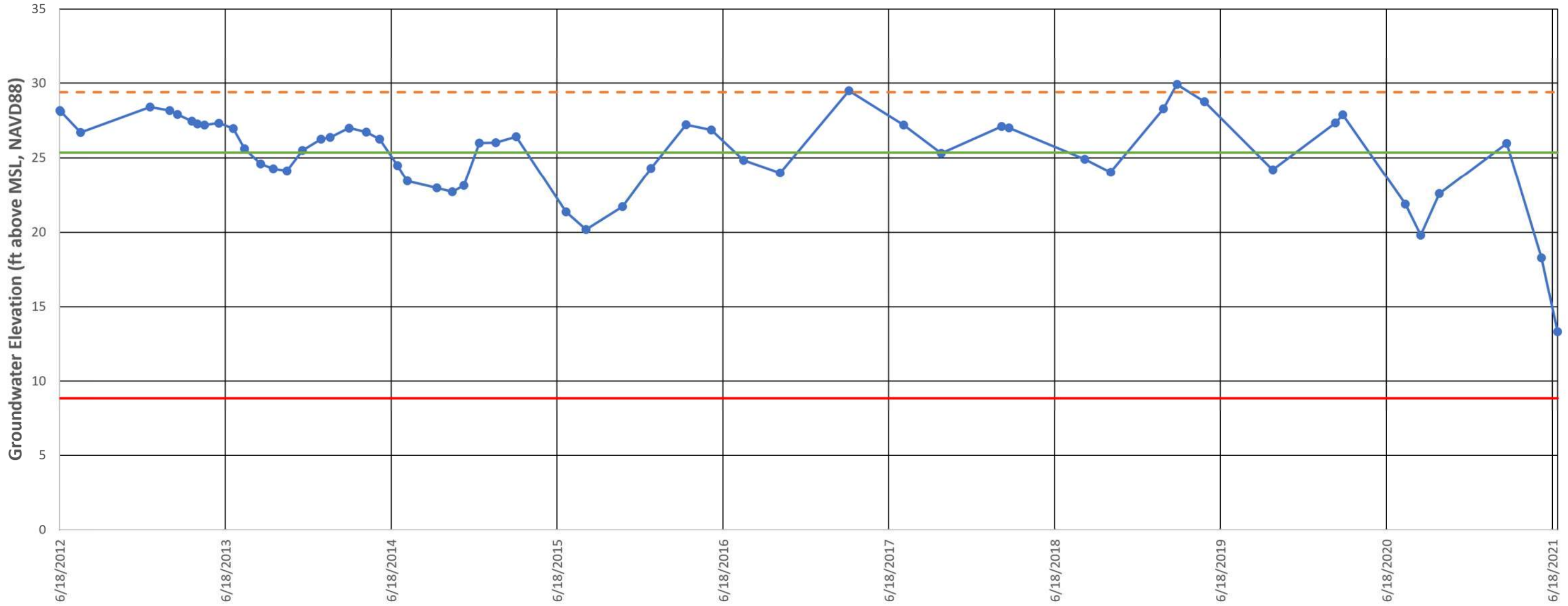

- Groundwater Level
- - - Ground Surface Elevation
- Measurable Objective
- Minimum Threshold

Operational Range: 16.5 ft
 MT Method Selected: Minimum Operating Range

Site Code: 390244N1217813W003
 SWN: 14N02E32D003M
 Local ID: SMWC MW-1C
 Other ID: N/A

Ground Surface Elevation: 29.4 NAVD88 ft
 Depth: 500 ft bgs
 Screen Interval - 1: 460 - 490 ft bgs
 Screen Interval - 2: N/A - N/A ft bgs
 Aquifer Zone: AZ-3

Sutter County MW-1C

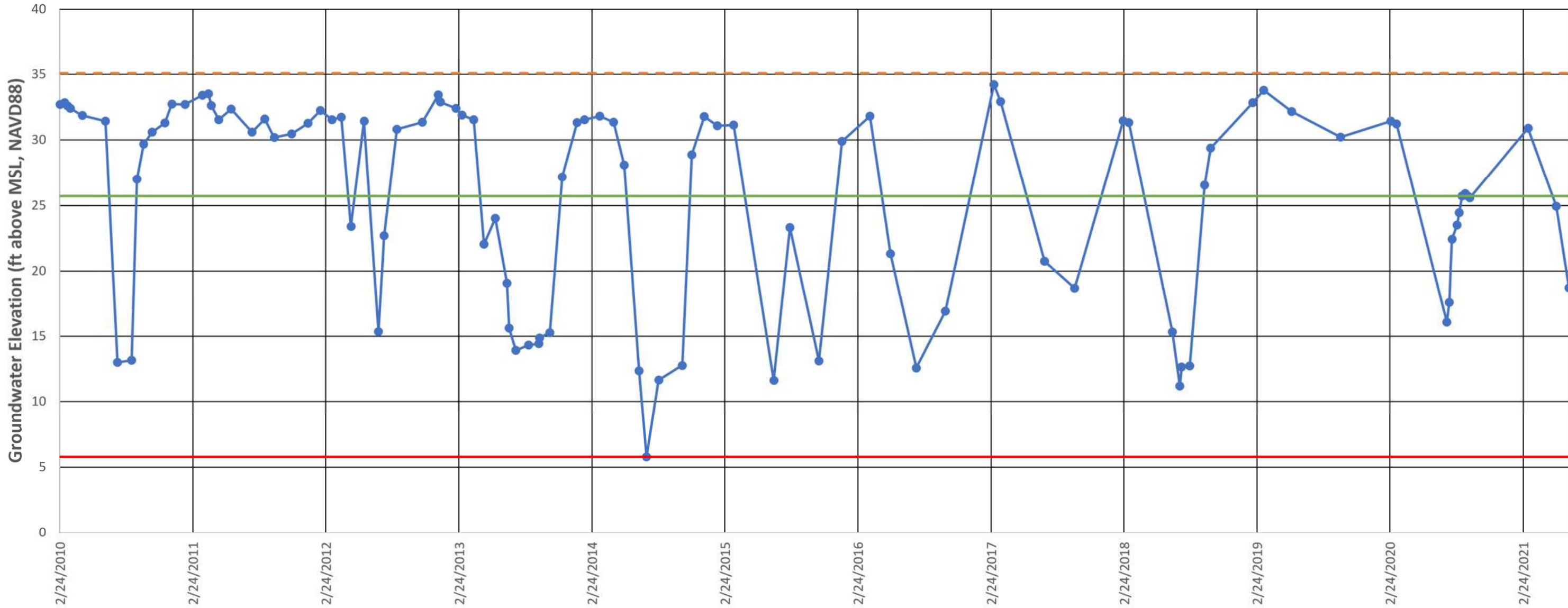

- Groundwater Level
- - - Ground Surface Elevation
- Measurable Objective
- Minimum Threshold

Operational Range: 19.95 ft
 MT Method Selected: Historic Low

Site Code: 390696N1217778W003
 SWN: 14N02E17C003M
 Local ID: Sutter County MW-1C
 Other ID: N/A

Ground Surface Elevation: 35.079 NAVD88 ft
 Depth: 425 ft bgs
 Screen Interval - 1: 395 - 415 ft bgs
 Screen Interval - 2: N/A - N/A ft bgs
 Aquifer Zone: AZ-3

Sutter County MW-1D

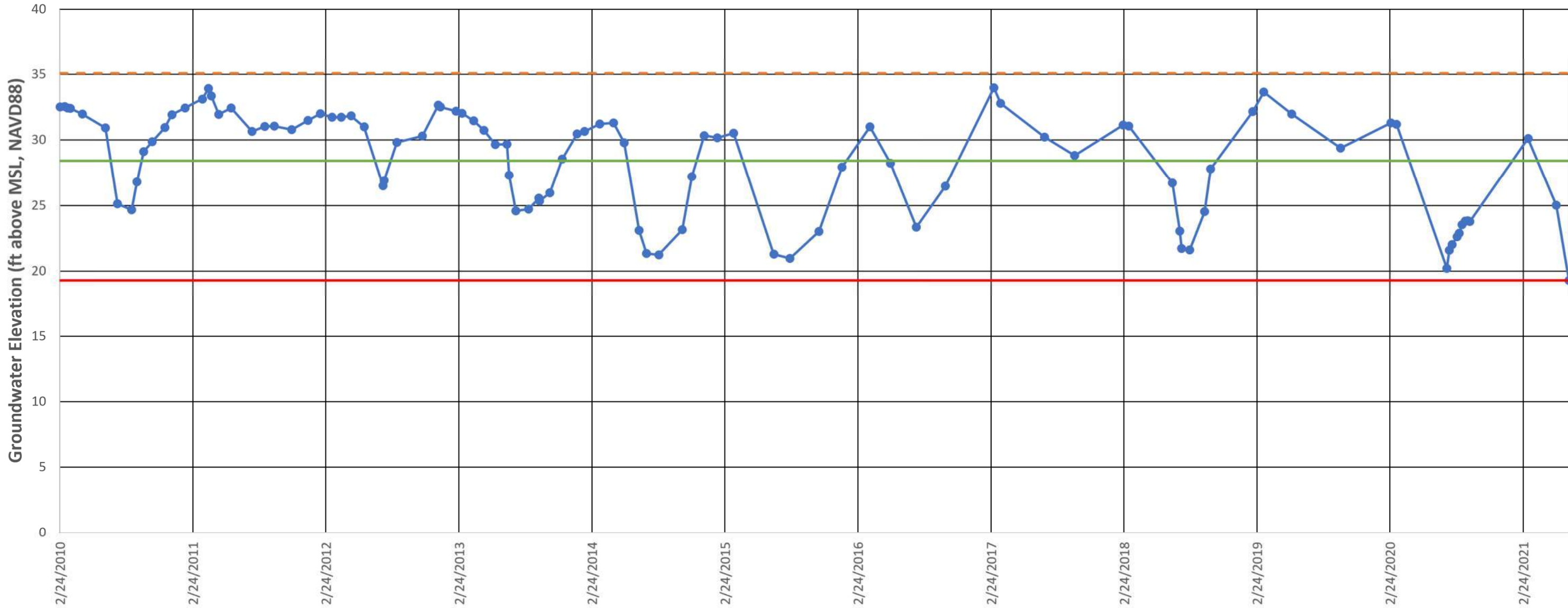

- Groundwater Level
- - - Ground Surface Elevation
- Measurable Objective
- Minimum Threshold

Operational Range: 9.12 ft
 MT Method Selected: Historic Low

Site Code: 390696N1217778W004
 SWN: 14N02E17C004M
 Local ID: Sutter County MW-1D
 Other ID: N/A

Ground Surface Elevation: 35.079 NAVD88 ft
 Depth: 755 ft bgs
 Screen Interval - 1: 725 - 745 ft bgs
 Screen Interval - 2: N/A - N/A ft bgs
 Aquifer Zone: AZ-3

Sutter County MW-2C

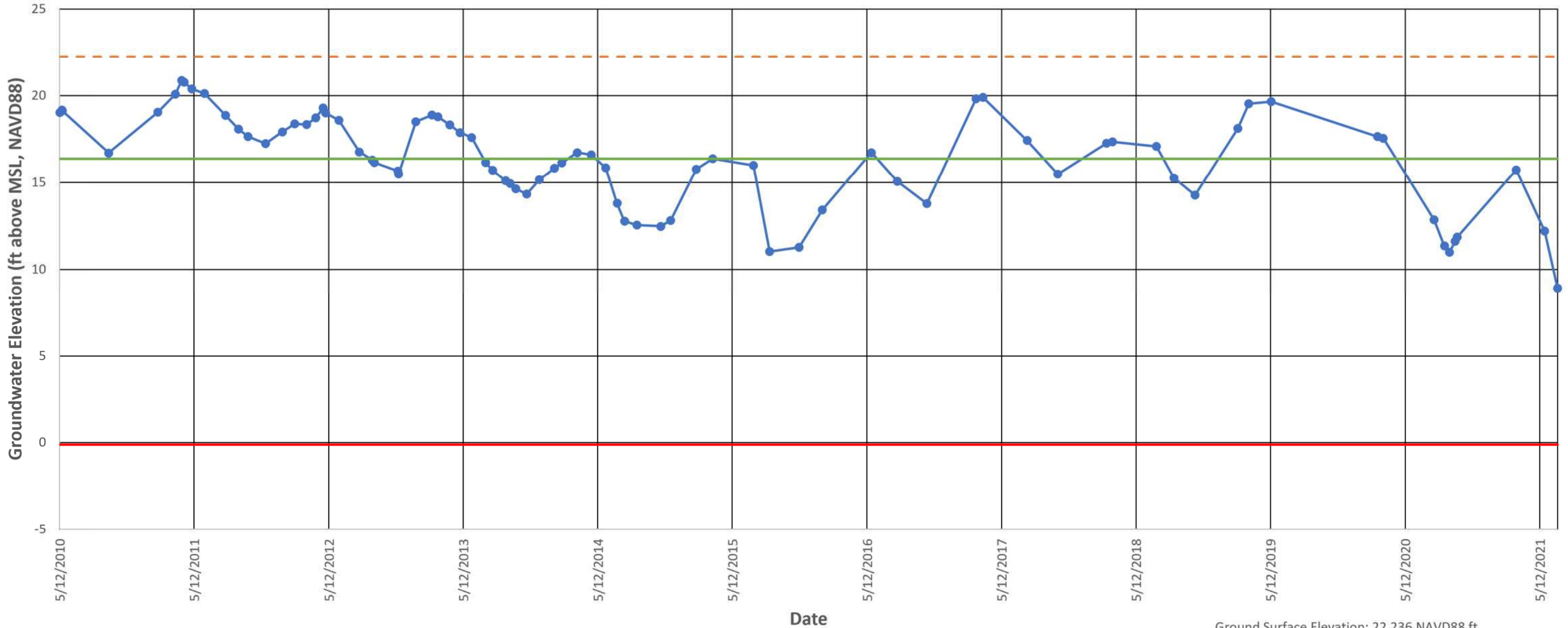

- Groundwater Level
- - - Ground Surface Elevation
- Measurable Objective
- Minimum Threshold

Operational Range: 16.5 ft
 MT Method Selected: Minimum Operating Range

Site Code: 388761N1217094W003
 SWN: 12N02E23H003M
 Local ID: Sutter County MW-2C
 Other ID: N/A

Ground Surface Elevation: 22.236 NAVD88 ft
 Depth: 600 ft bgs
 Screen Interval - 1: 570 - 590 ft bgs
 Screen Interval - 2: N/A - N/A ft bgs
 Aquifer Zone: AZ-3

Sutter County MW-2D

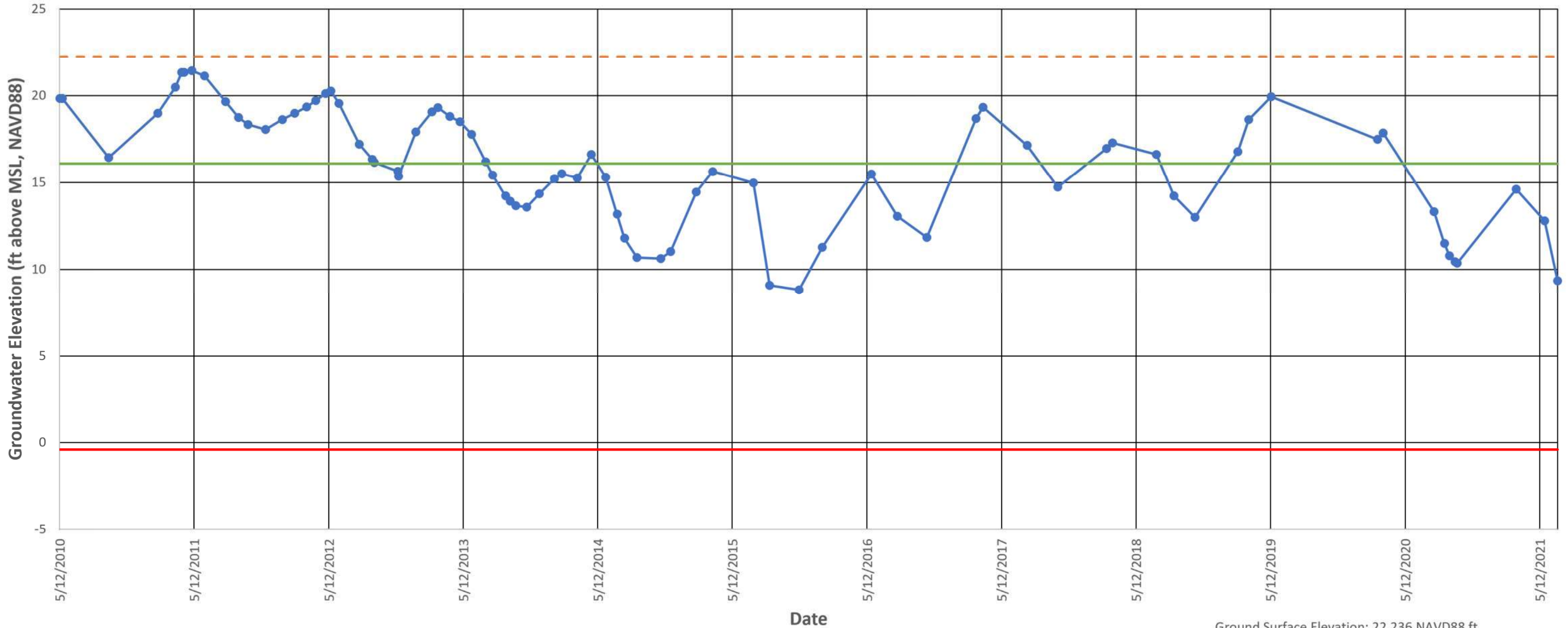

- Groundwater Level
- - - Ground Surface Elevation
- Measurable Objective
- Minimum Threshold

Operational Range: 16.5 ft
 MT Method Selected: Minimum Operating Range

Site Code: 388761N1217094W004
 SWN: 12N02E23H004M
 Local ID: Sutter County MW-2D
 Other ID: N/A

Ground Surface Elevation: 22.236 NAVD88 ft
 Depth: 705 ft bgs
 Screen Interval - 1: 655 - 665 ft bgs
 Screen Interval - 2: 685 - 695 ft bgs
 Aquifer Zone: AZ-3

Sutter County MW-3C

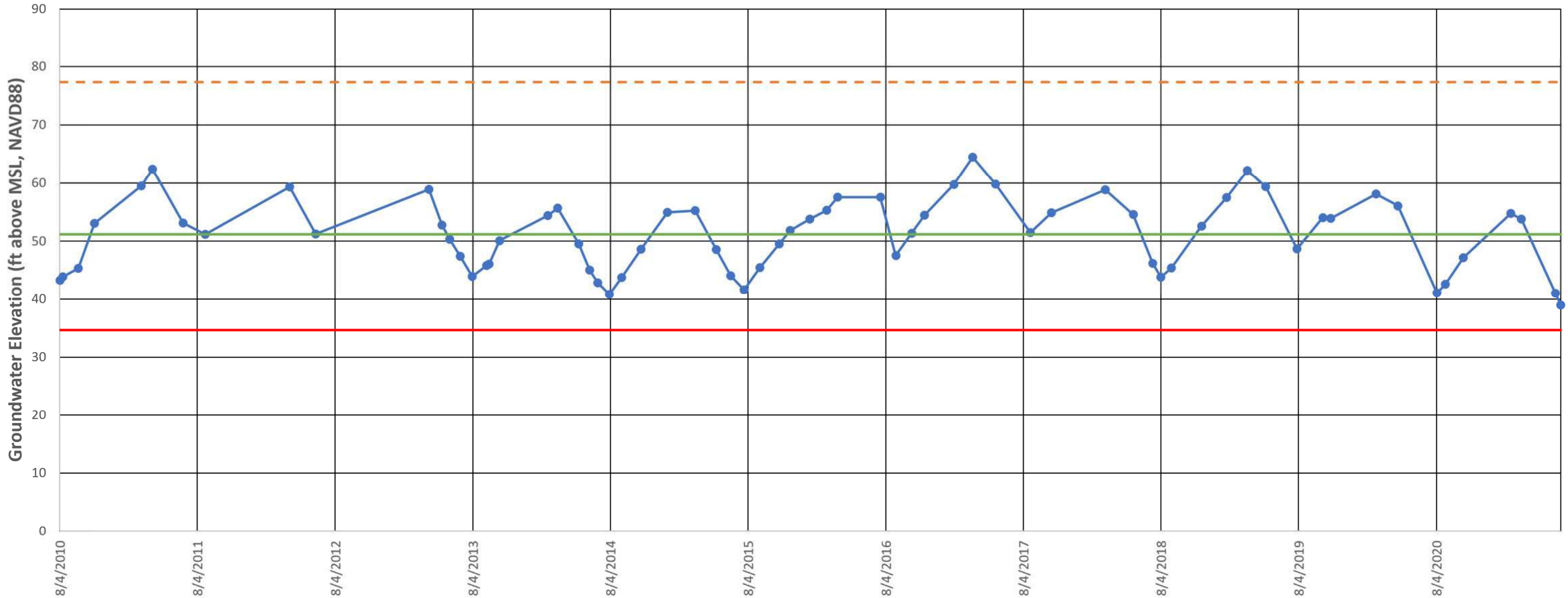

- Groundwater Level
- - - Ground Surface Elevation
- Measurable Objective
- Minimum Threshold

Operational Range: 16.5 ft
 MT Method Selected: Minimum Operating Range

Site Code: 392394N1216509W003
 SWN: 16N03E17J003M
 Local ID: Sutter County MW-3C
 Other ID: N/A

Ground Surface Elevation: 77.35 NAVD88 ft
 Depth: 430 ft bgs
 Screen Interval - 1: 400 - 420 ft bgs
 Screen Interval - 2: N/A - N/A ft bgs
 Aquifer Zone: AZ-3

Sutter County MW-3D

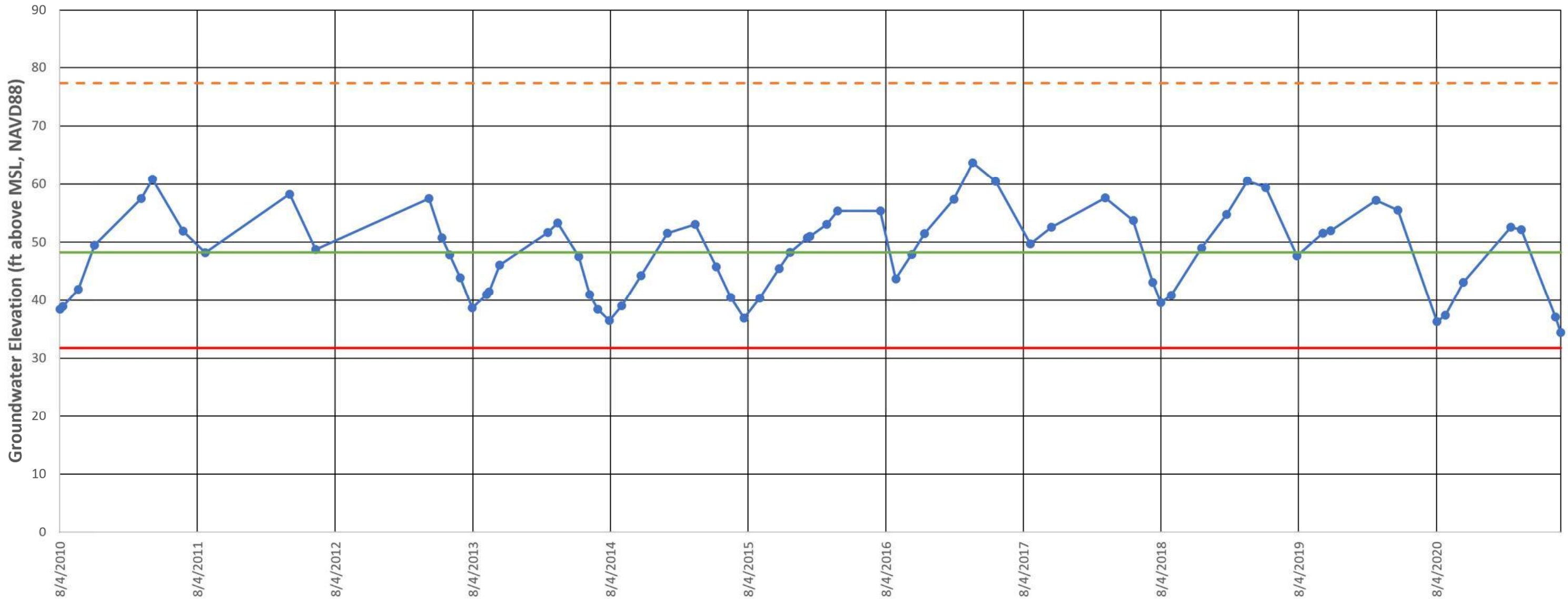

- Groundwater Level
- - - Ground Surface Elevation
- Measurable Objective
- Minimum Threshold

Operational Range: 16.5 ft
 MT Method Selected: Minimum Operating Range

Site Code: 392394N1216509W004
 SWN: 16N03E17J004M
 Local ID: Sutter County MW-3D
 Other ID: N/A

Ground Surface Elevation: 77.35 NAVD88 ft
 Depth: 615 ft bgs
 Screen Interval - 1: 595 - 605 ft bgs
 Screen Interval - 2: N/A - N/A ft bgs
 Aquifer Zone: AZ-3

Sutter County MW-3E

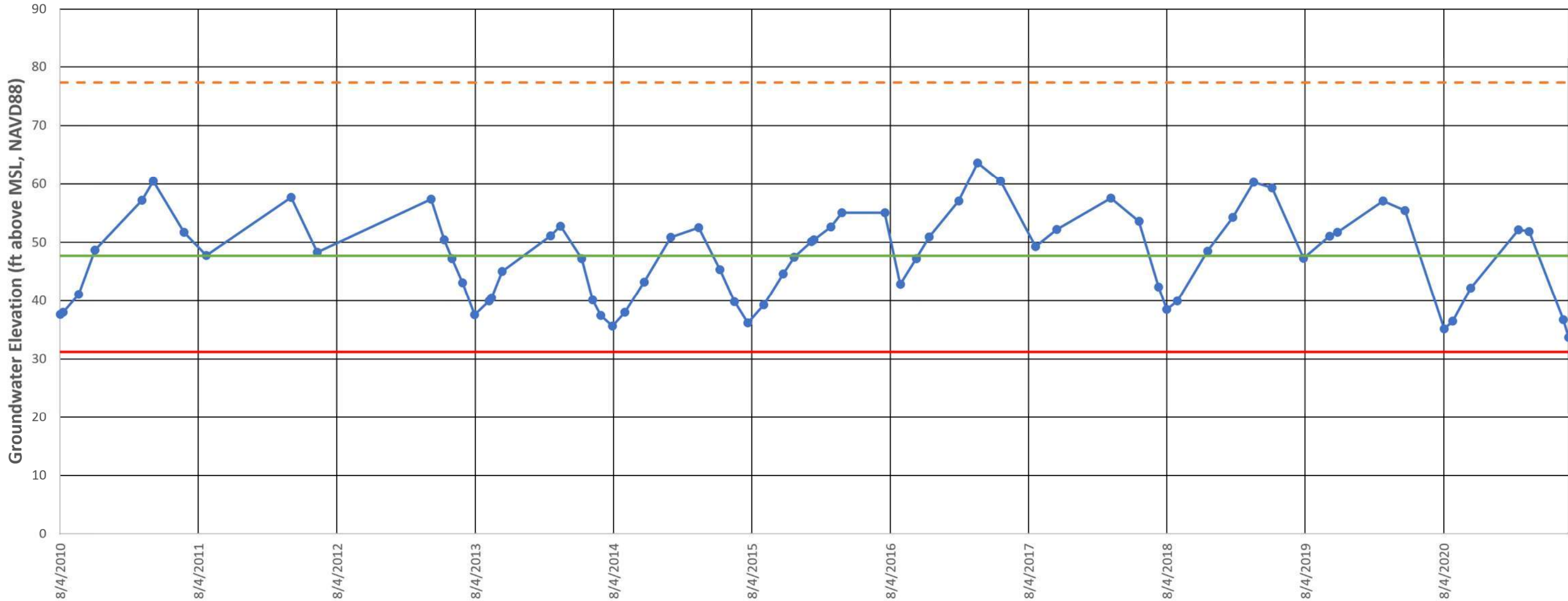

- Groundwater Level
- - - Ground Surface Elevation
- Measurable Objective
- Minimum Threshold

Operational Range: 16.5 ft
 MT Method Selected: Minimum Operating Range

Site Code: 392394N1216509W005
 SWN: 16N03E17J005M
 Local ID: Sutter County MW-3E
 Other ID: N/A

Ground Surface Elevation: 77.35 NAVD88 ft
 Depth: 785 ft bgs
 Screen Interval - 1: 765 - 785 ft bgs
 Screen Interval - 2: N/A - N/A ft bgs
 Aquifer Zone: AZ-3

Sutter County MW-4B

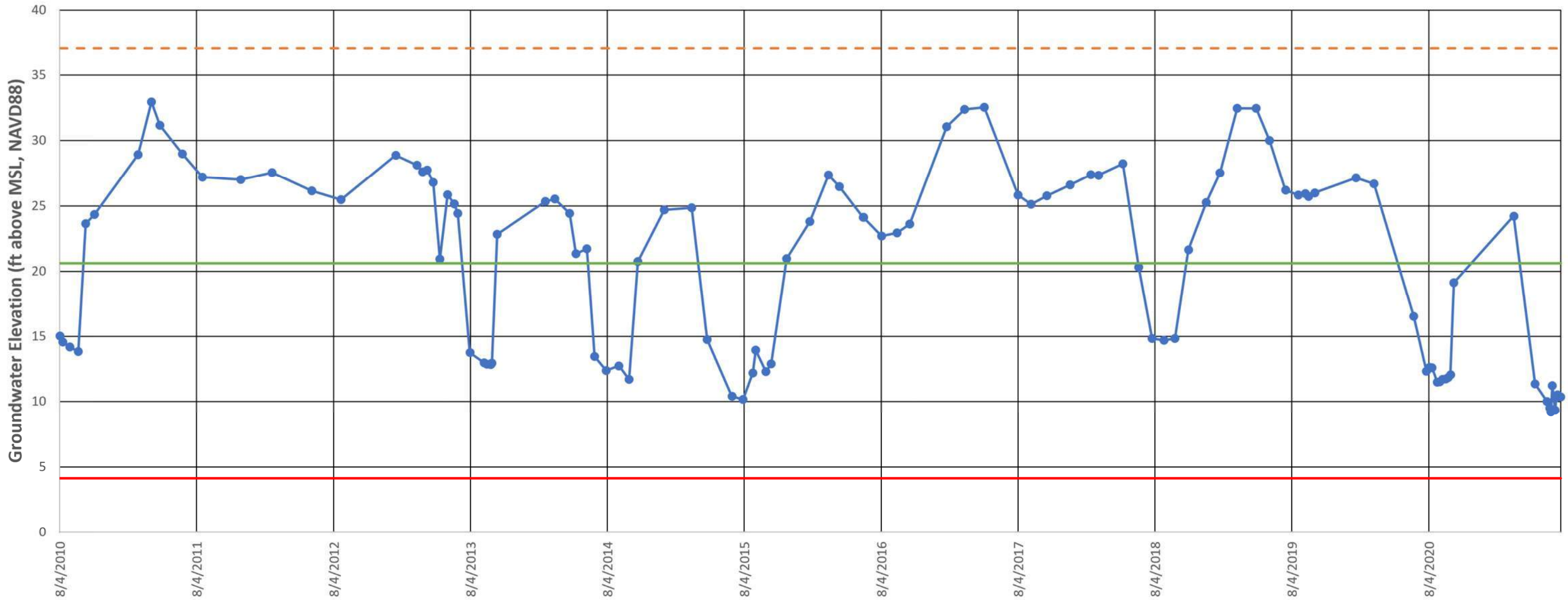

- Groundwater Level
- - - Ground Surface Elevation
- Measurable Objective
- Minimum Threshold

Operational Range: 16.5 ft
 MT Method Selected: Minimum Operating Range

Site Code: 389452N1215992W002
 SWN: 13N03E26J003M
 Local ID: Sutter County MW-4B
 Other ID: N/A

Ground Surface Elevation: 37.081 NAVD88 ft
 Depth: 445 ft bgs
 Screen Interval - 1: 425 - 435 ft bgs
 Screen Interval - 2: N/A - N/A ft bgs
 Aquifer Zone: AZ-3

Sutter County MW-4C

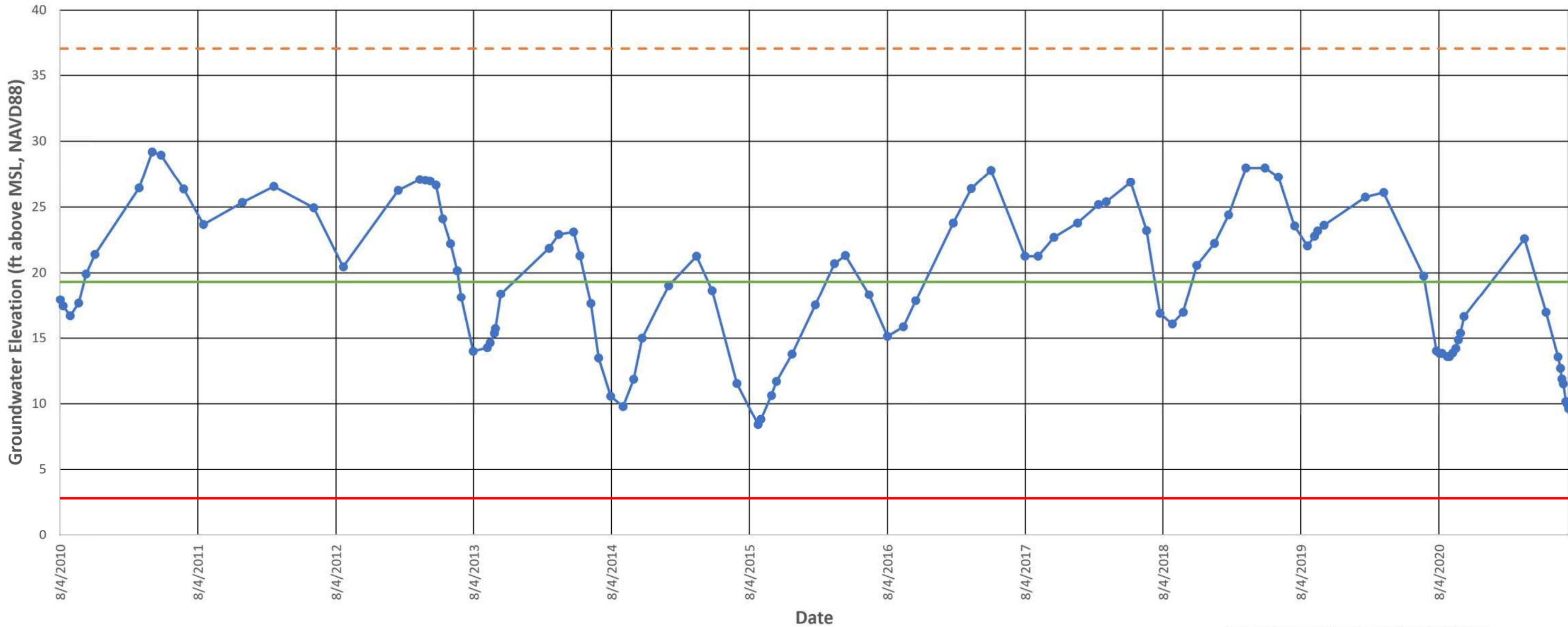

- Groundwater Level
- - - Ground Surface Elevation
- Measurable Objective
- Minimum Threshold

Operational Range: 16.5 ft
 MT Method Selected: Minimum Operating Range

Site Code: 389452N1215992W003
 SWN: 13N03E26J004M
 Local ID: Sutter County MW-4C
 Other ID: N/A

Ground Surface Elevation: 37.081 NAVD88 ft
 Depth: 610 ft bgs
 Screen Interval - 1: 590 - 600 ft bgs
 Screen Interval - 2: N/A - N/A ft bgs
 Aquifer Zone: AZ-3

Sutter County MW-4D

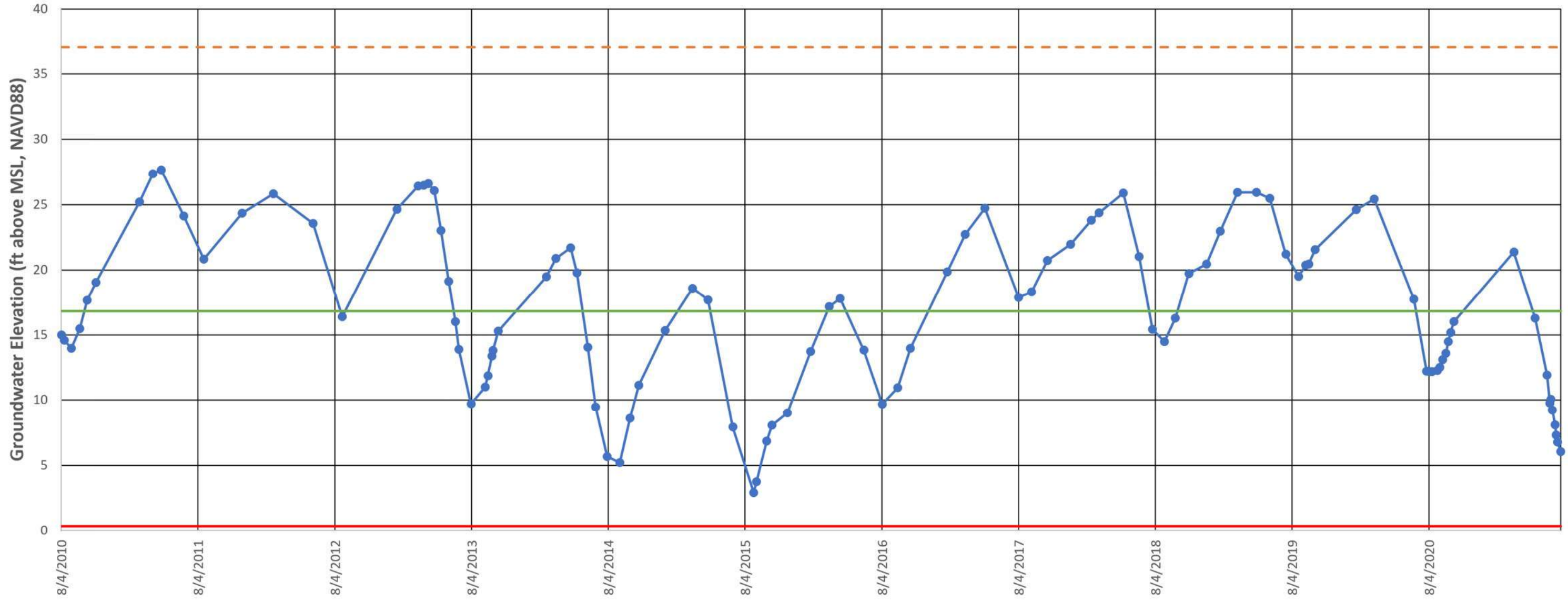

- Groundwater Level
- - - Ground Surface Elevation
- Measurable Objective
- Minimum Threshold

Operational Range: 16.5 ft
 MT Method Selected: Minimum Operating Range

Site Code: 389452N1215992W004
 SWN: 13N03E26J005M
 Local ID: Sutter County MW-4D
 Other ID: N/A

Ground Surface Elevation: 37.081 NAVD88 ft
 Depth: 1005 ft bgs
 Screen Interval - 1: 985 - 995 ft bgs
 Screen Interval - 2: N/A - N/A ft bgs
 Aquifer Zone: AZ-3

Interconnected Surface Water

12N03E18H001M

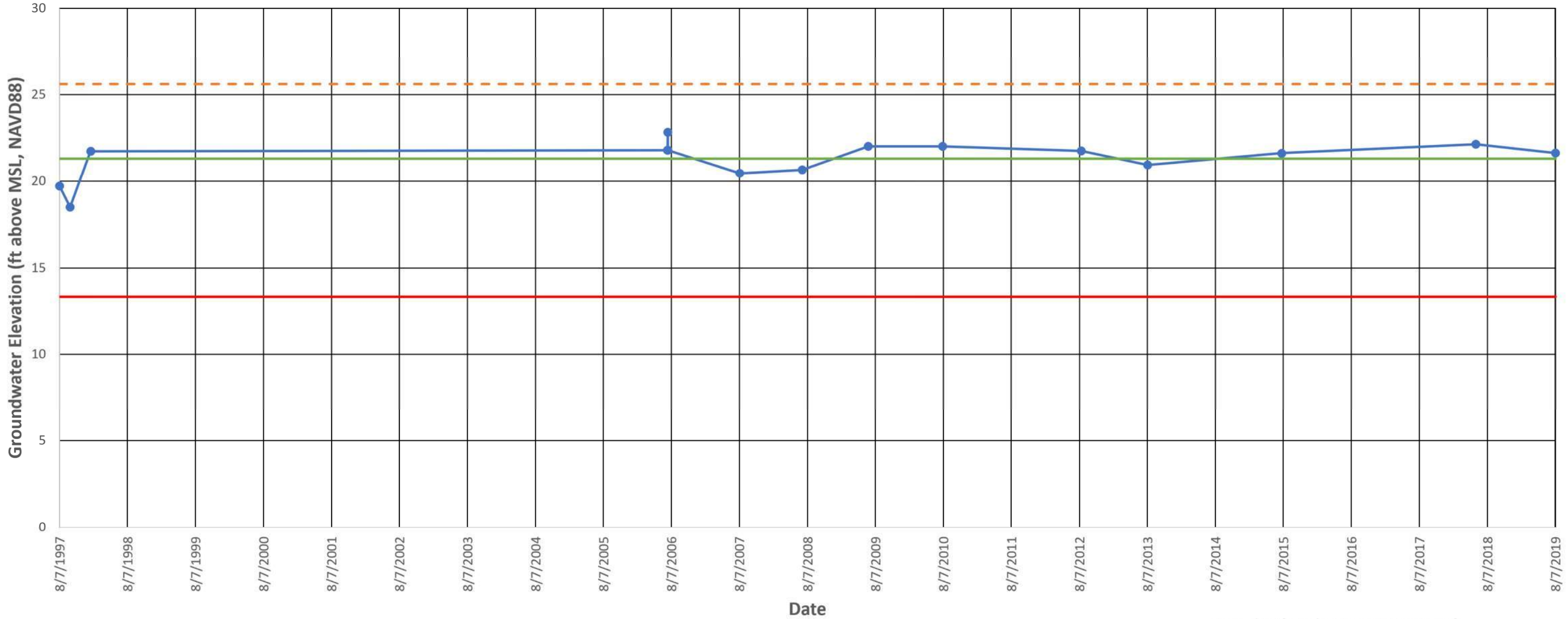

- Groundwater Level
- Ground Surface Elevation
- Measurable Objective
- Minimum Threshold

Operational Range: 8 ft
MT Method Selected: Minimum Operating Range

Site Code: N/A
SWN: 12N03E18H001M
Local ID: N/A
Other ID: USGS-385314121401701

Ground Surface Elevation: 25.6 NAVD88 ft
Depth: 50 ft bgs
Screen Interval - 1: N/A - N/A ft bgs
Screen Interval - 2: N/A - N/A ft bgs
Aquifer Zone: Shallow

14N02E10R001M

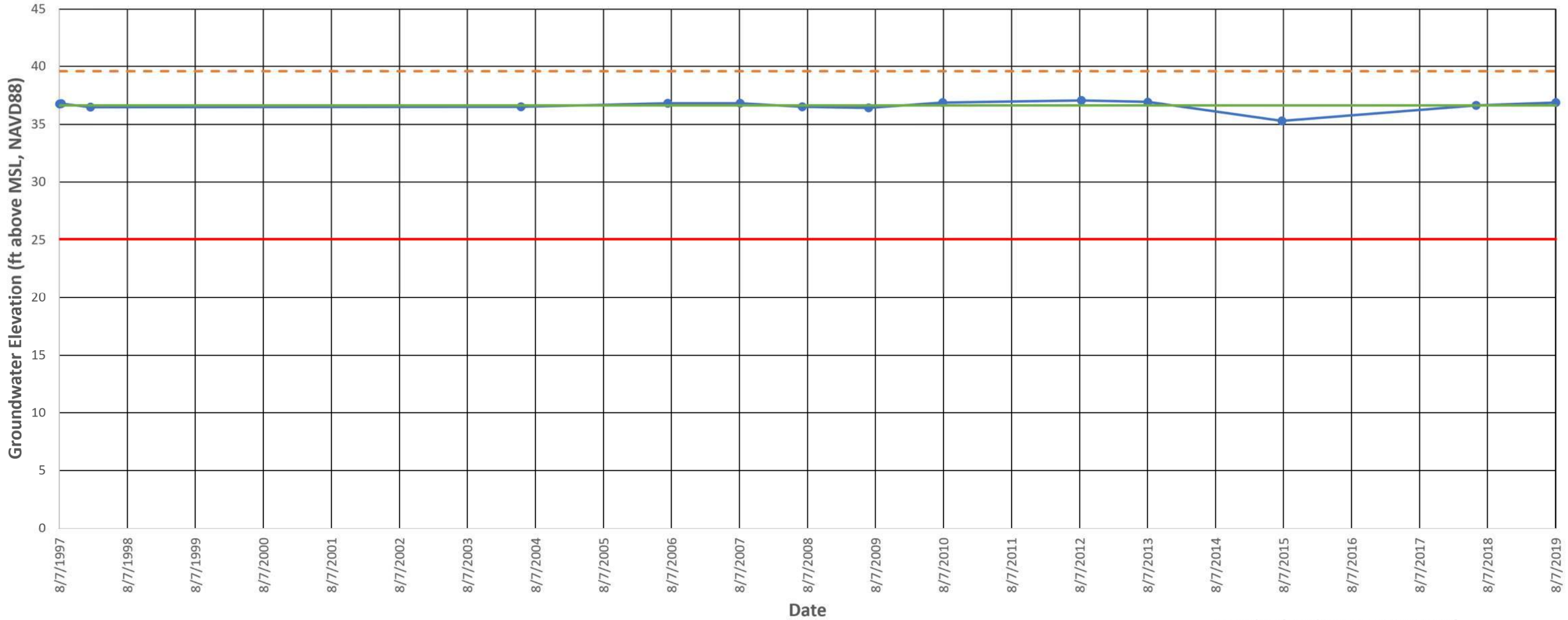

- Groundwater Level
- Ground Surface Elevation
- Measurable Objective
- Minimum Threshold

Operational Range: 11.55 ft
MT Method Selected: 90% avg projected elevation with +50% ET

Site Code: N/A
SWN: 14N02E10R001M
Local ID: N/A
Other ID: USGS-390416121433601

Ground Surface Elevation: 39.6 NAVD88 ft
Depth: 44 ft bgs
Screen Interval - 1: N/A - N/A ft bgs
Screen Interval - 2: N/A - N/A ft bgs
Aquifer Zone: Shallow

15N02E20D001M

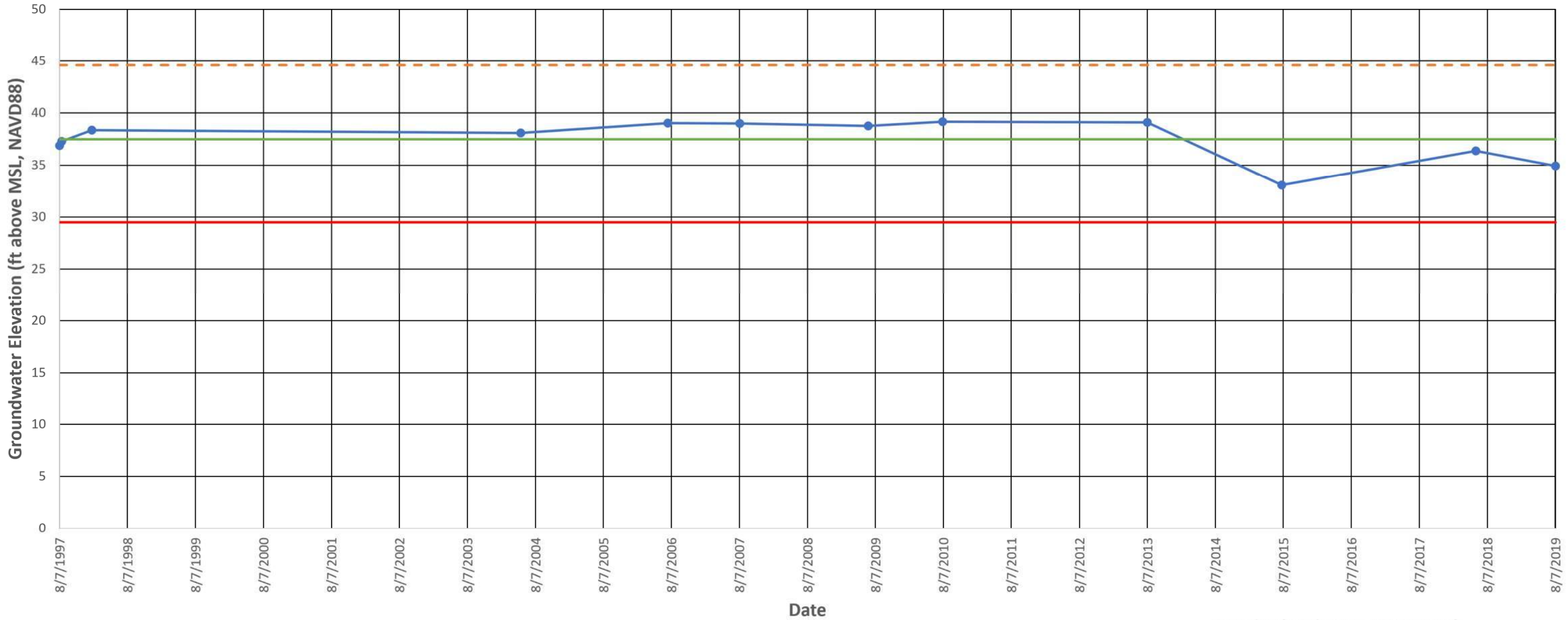

- Groundwater Level
- Ground Surface Elevation
- Measurable Objective
- Minimum Threshold

Operational Range: 8 ft
MT Method Selected: Minimum Operating Range

Site Code: N/A
SWN: 15N02E20D001M
Local ID: N/A
Other ID: USGS-390832121463601

Ground Surface Elevation: 44.6 NAVD88 ft
Depth: 35 ft bgs
Screen Interval - 1: N/A - N/A ft bgs
Screen Interval - 2: N/A - N/A ft bgs
Aquifer Zone: Shallow

16N01E31H001M

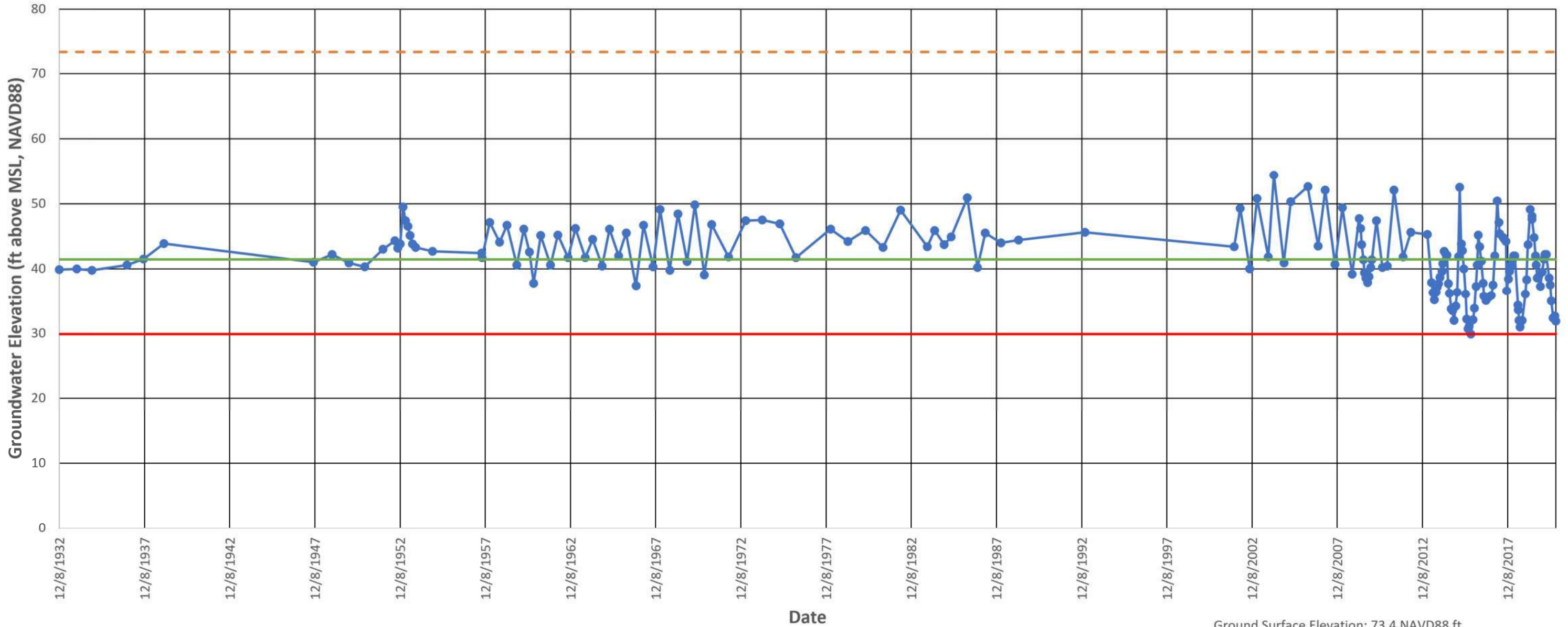

- Groundwater Level
- Ground Surface Elevation
- Measurable Objective
- Minimum Threshold

Operational Range: 11.56 ft
MT Method Selected: Historic Low

Site Code: 391975N1218937W001
SWN: 16N01E31H001M
Local ID: N/A
Other ID: N/A

Ground Surface Elevation: 73.4 NAVD88 ft
Depth: 0 ft bgs
Screen Interval - 1: N/A - N/A ft bgs
Screen Interval - 2: N/A - N/A ft bgs
Aquifer Zone: Shallow

16N03E21D002M

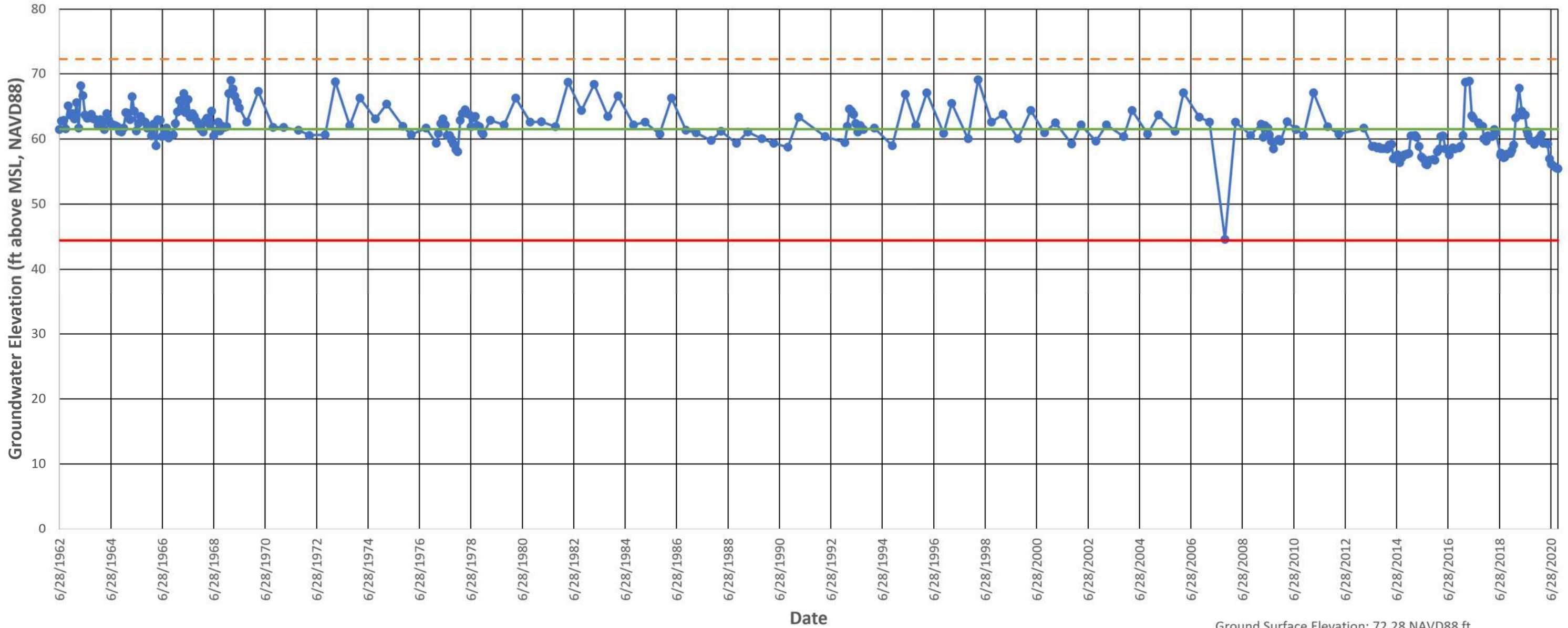

- Groundwater Level
- - - Ground Surface Elevation
- Measurable Objective
- Minimum Threshold

Operational Range: 17.1 ft
 MT Method Selected: 90% avg projected elevation with +50% ET

Site Code: 392328N1216469W001
 SWN: 16N03E21D002M
 Local ID: N/A
 Other ID: N/A

Ground Surface Elevation: 72.28 NAVD88 ft
 Depth: 0 ft bgs
 Screen Interval - 1: N/A - N/A ft bgs
 Screen Interval - 2: N/A - N/A ft bgs
 Aquifer Zone: Shallow

GH East MW Site

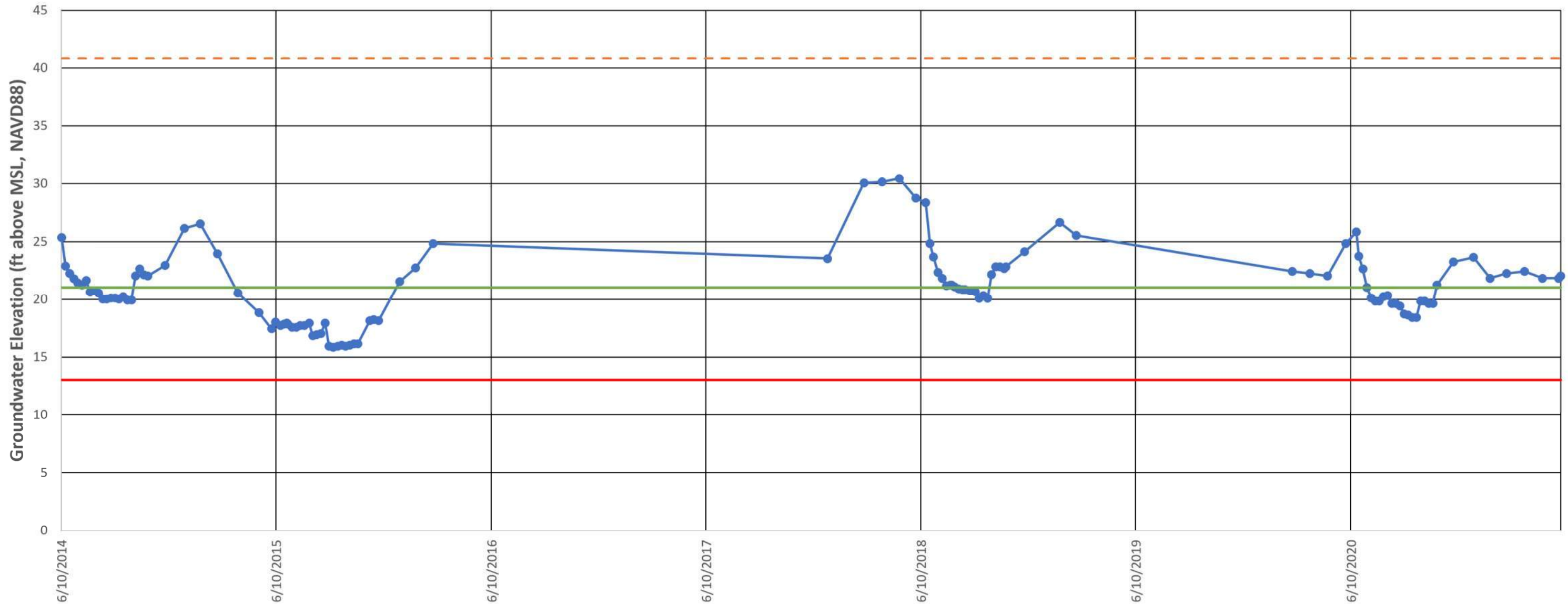

- Groundwater Level
- - - Ground Surface Elevation
- Measurable Objective
- Minimum Threshold

Operational Range: 8 ft
 MT Method Selected: Minimum Operating Range

Site Code: 389563N1215843W001
 SWN: N/A
 Local ID: GH East MW Site
 Other ID: N/A

Ground Surface Elevation: 40.85 NAVD88 ft
 Depth: 40 ft bgs
 Screen Interval - 1: 30 - 40 ft bgs
 Screen Interval - 2: N/A - N/A ft bgs
 Aquifer Zone: Shallow

GH North MW Site

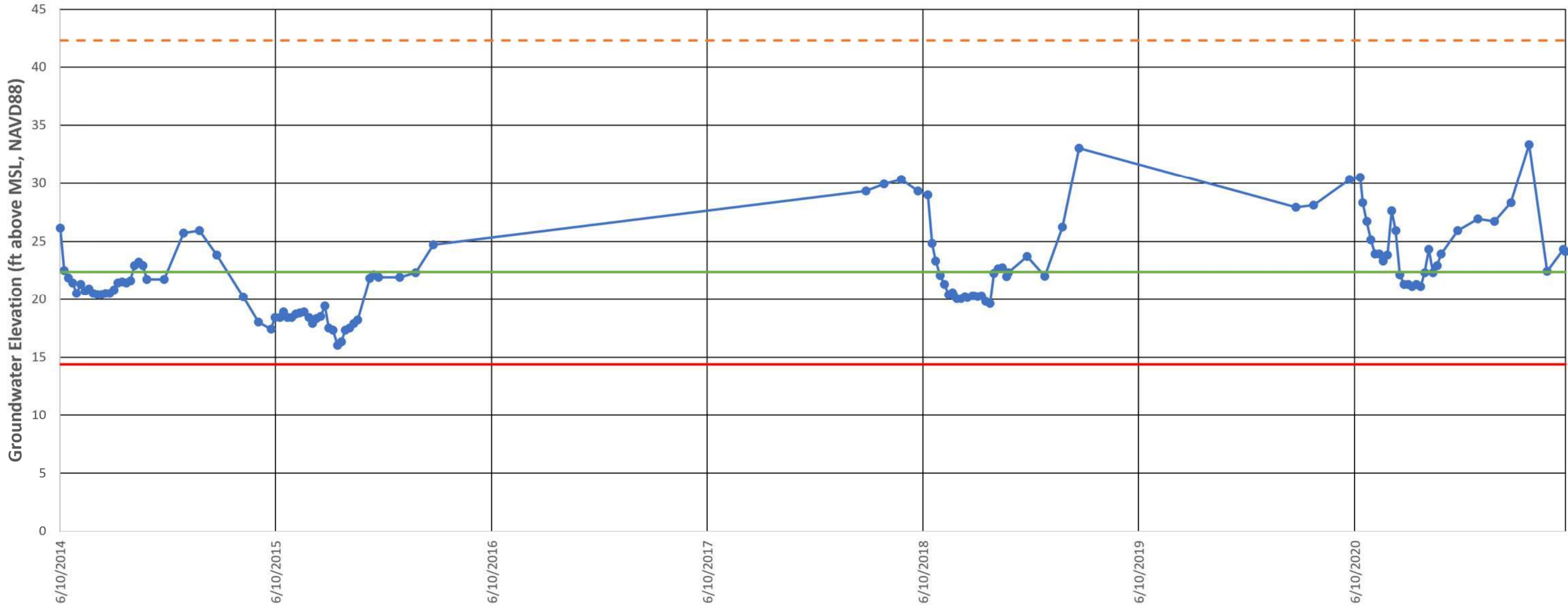

Date

- Groundwater Level
- - - Ground Surface Elevation
- Measurable Objective
- Minimum Threshold

Operational Range: 8 ft

MT Method Selected: Minimum Operating Range

Site Code: 389571N1215858W001

SWN: N/A

Local ID: GH North MW Site

Other ID: N/A

Ground Surface Elevation: 42.33 NAVD88 ft

Depth: 40 ft bgs

Screen Interval - 1: 30 - 40 ft bgs

Screen Interval - 2: N/A - N/A ft bgs

Aquifer Zone: Shallow

12N01E01A001M

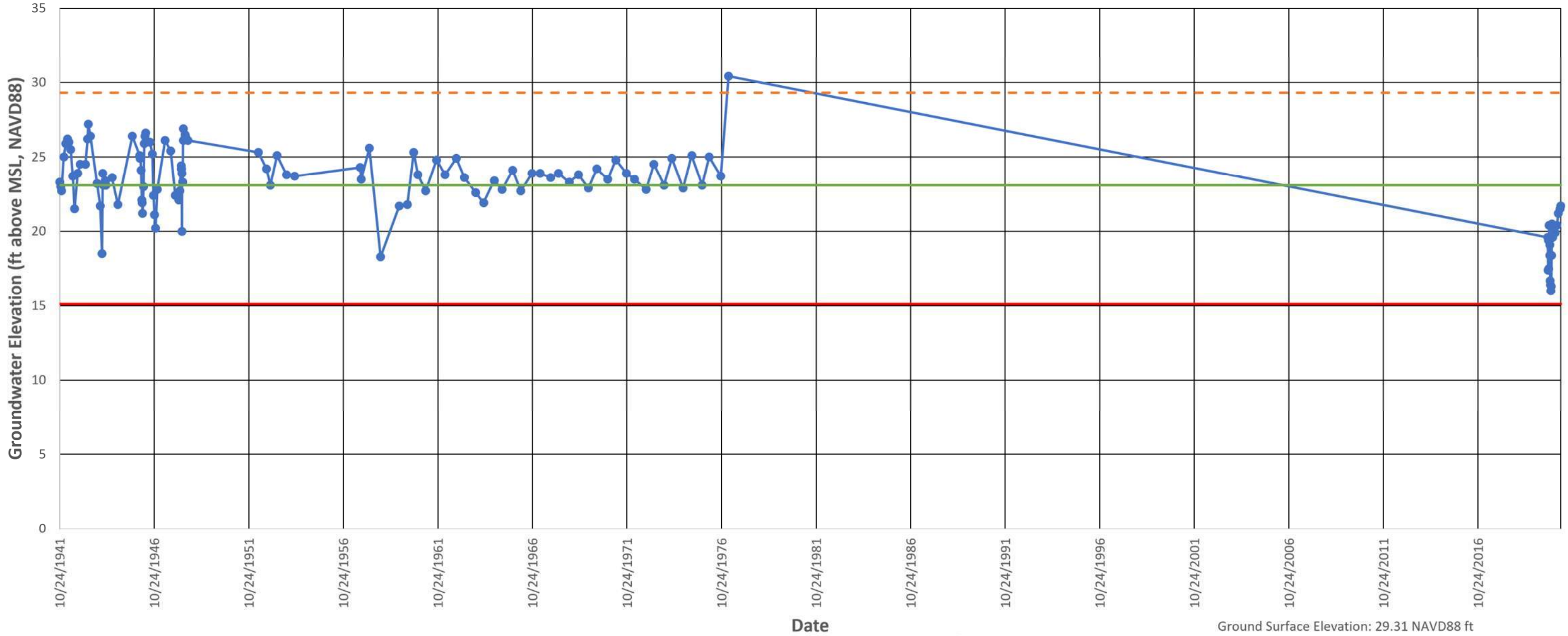

- Groundwater Level
- Ground Surface Elevation
- Measurable Objective
- Minimum Threshold

Operational Range: 8 ft
MT Method Selected: Minimum Operating Range

Site Code: 389233N1218022W001
SWN: 12N01E01A001M
Local ID: N/A
Other ID: N/A

Ground Surface Elevation: 29.31 NAVD88 ft
Depth: 75 ft bgs
Screen Interval - 1: N/A - N/A ft bgs
Screen Interval - 2: N/A - N/A ft bgs
Aquifer Zone: AZ-1

13N01E11A001M

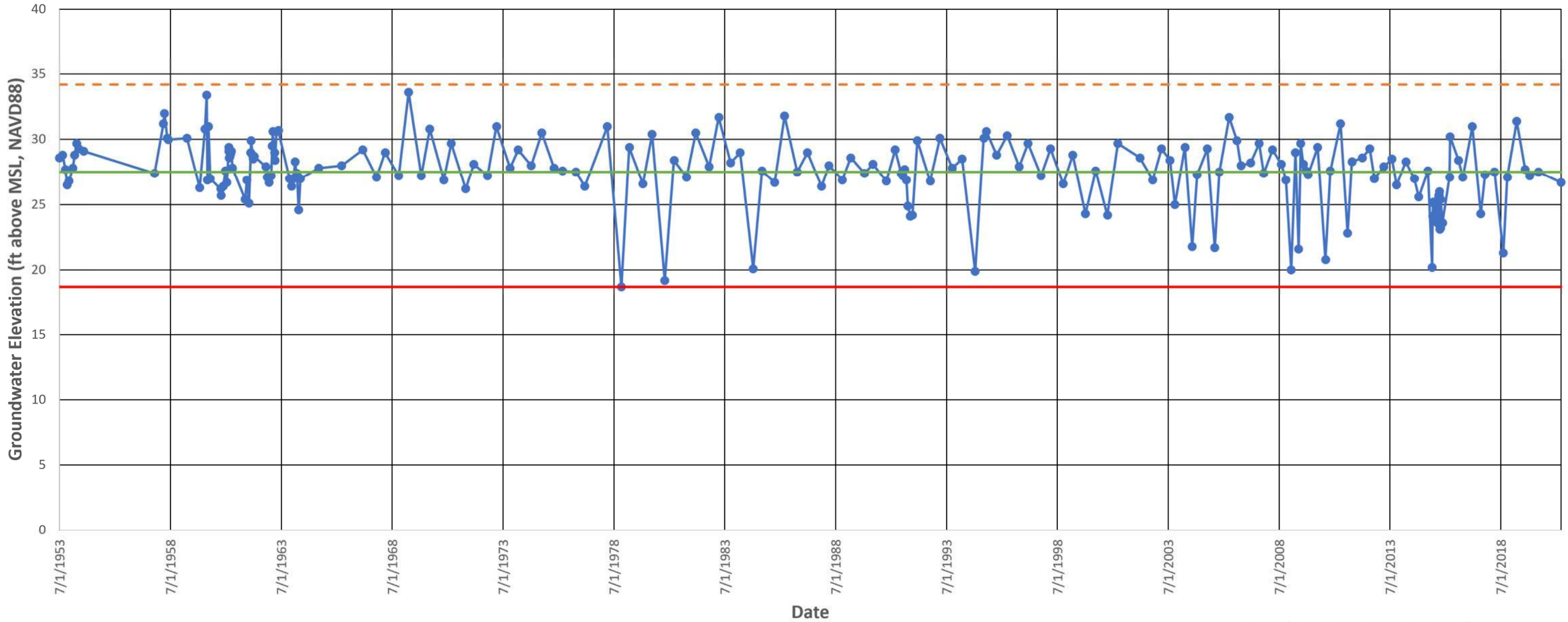

- Groundwater Level
- Ground Surface Elevation
- Measurable Objective
- Minimum Threshold

Operational Range: 8.81 ft
MT Method Selected: Historic Low

Site Code: 389937N1218240W001
SWN: 13N01E11A001M
Local ID: N/A
Other ID: N/A

Ground Surface Elevation: 34.19 NAVD88 ft
Depth: 145 ft bgs
Screen Interval - 1: N/A - N/A ft bgs
Screen Interval - 2: N/A - N/A ft bgs
Aquifer Zone: AZ-1

Feather River MW-1A

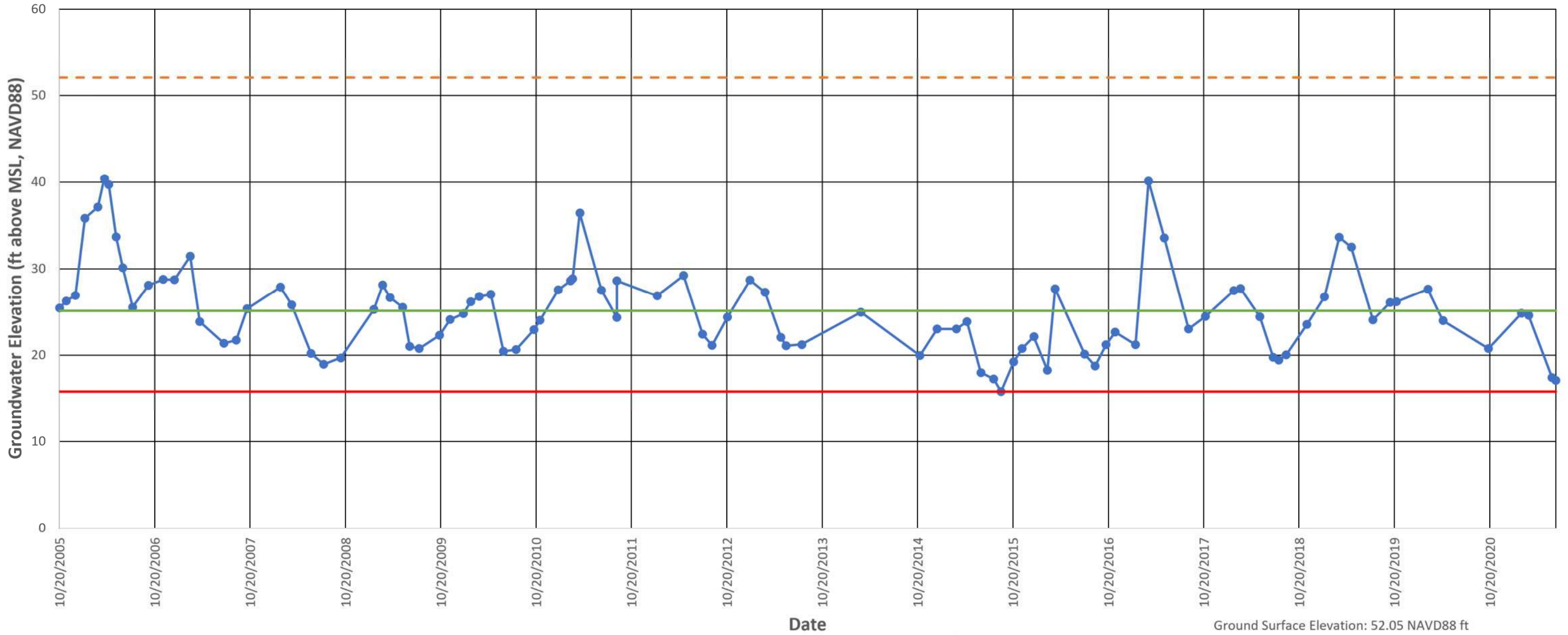

- Groundwater Level
- - - Ground Surface Elevation
- Measurable Objective
- Minimum Threshold

Operational Range: 9.36 ft
 MT Method Selected: Historic Low

Site Code: 390458N1216114W001
 SWN: 14N03E23D003M
 Local ID: Feather River MW-1A
 Other ID: N/A

Ground Surface Elevation: 52.05 NAVD88 ft
 Depth: 65 ft bgs
 Screen Interval - 1: 40 - 60 ft bgs
 Screen Interval - 2: N/A - N/A ft bgs
 Aquifer Zone: AZ-1

GH Well 2

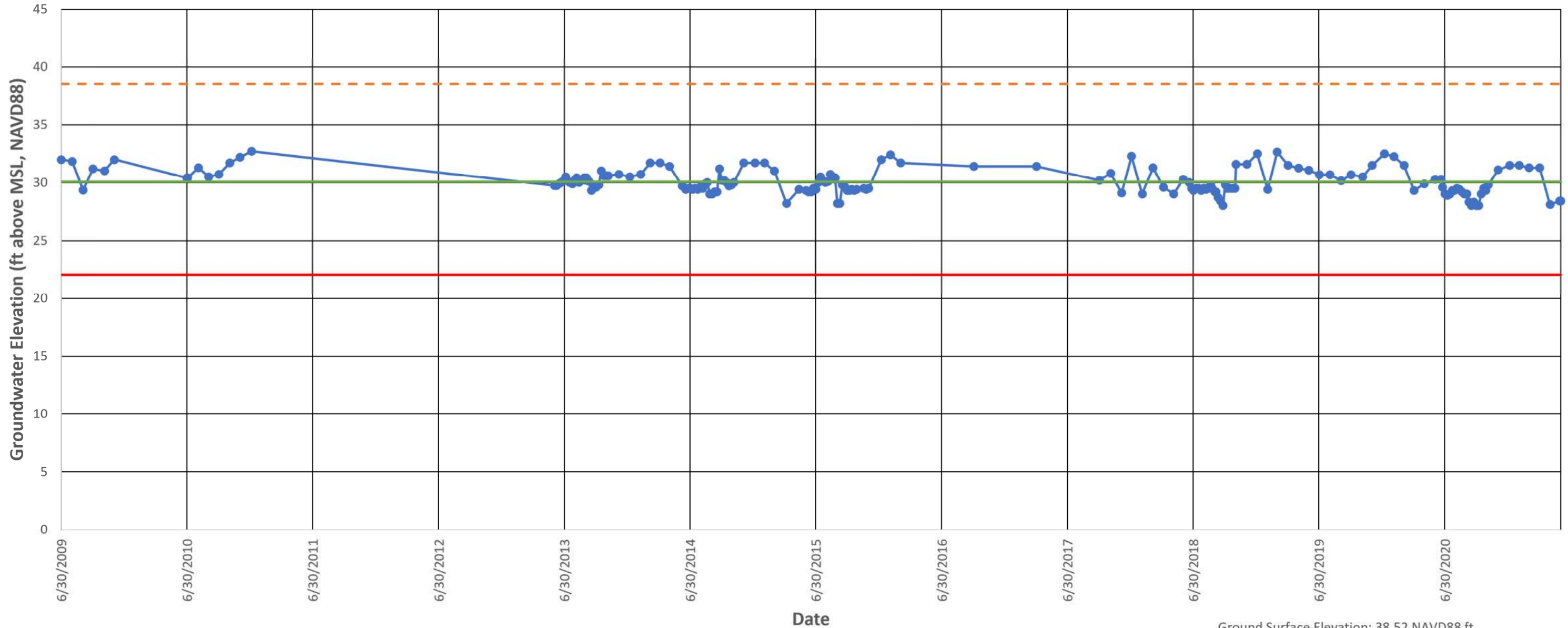

- Groundwater Level
- Ground Surface Elevation
- Measurable Objective
- Minimum Threshold

Operational Range: 8 ft
MT Method Selected: Minimum Operating Range

Site Code: 389453N1216159W001
SWN: N/A
Local ID: GH Well 2
Other ID: N/A

Ground Surface Elevation: 38.52 NAVD88 ft
Depth: 70 ft bgs
Screen Interval - 1: 50 - 70 ft bgs
Screen Interval - 2: N/A - N/A ft bgs
Aquifer Zone: AZ-1

GH Well 3

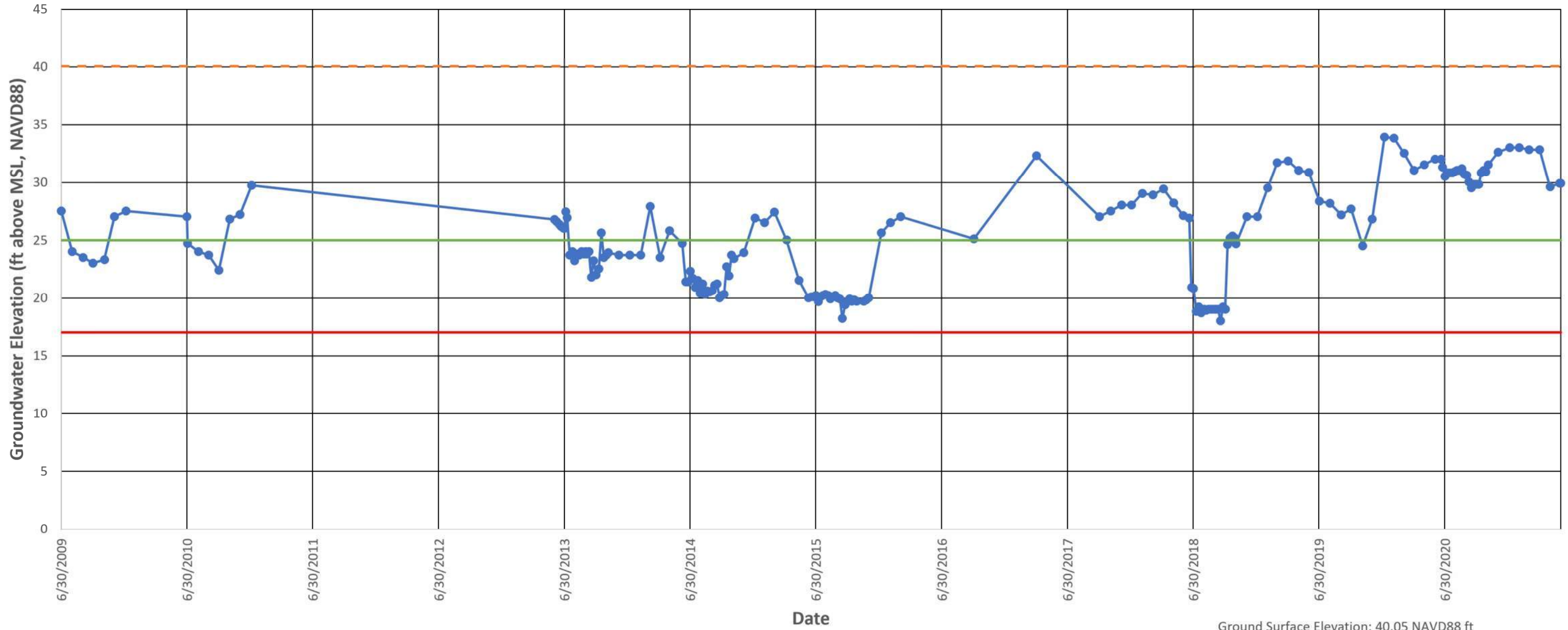

- Groundwater Level
- - - Ground Surface Elevation
- Measurable Objective
- Minimum Threshold

Operational Range: 8 ft
 MT Method Selected: Minimum Operating Range

Site Code: 389398N1216162W001
 SWN: N/A
 Local ID: GH Well 3
 Other ID: N/A

Ground Surface Elevation: 40.05 NAVD88 ft
 Depth: 100 ft bgs
 Screen Interval - 1: 52 - 100 ft bgs
 Screen Interval - 2: N/A - N/A ft bgs
 Aquifer Zone: AZ-1

GH Well 18

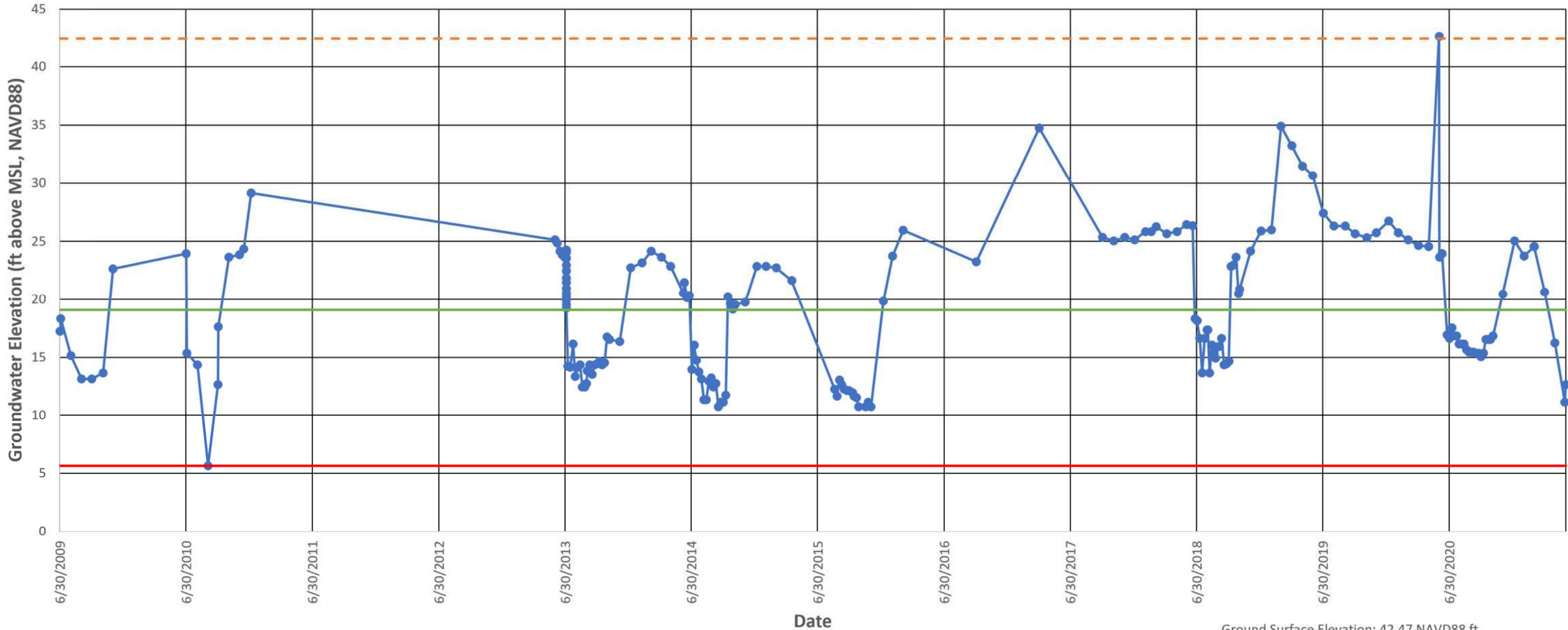

- Groundwater Level
- - - Ground Surface Elevation
- Measurable Objective
- Minimum Threshold

Operational Range: 13.43 ft
 MT Method Selected: Historic Low

Site Code: 389410N1215884W001
 SWN: N/A
 Local ID: GH Well 18
 Other ID: N/A

Ground Surface Elevation: 42.47 NAVD88 ft
 Depth: 150 ft bgs
 Screen Interval - 1: 90 - 100 ft bgs
 Screen Interval - 2: N/A - N/A ft bgs
 Aquifer Zone: AZ-1

Ma-1

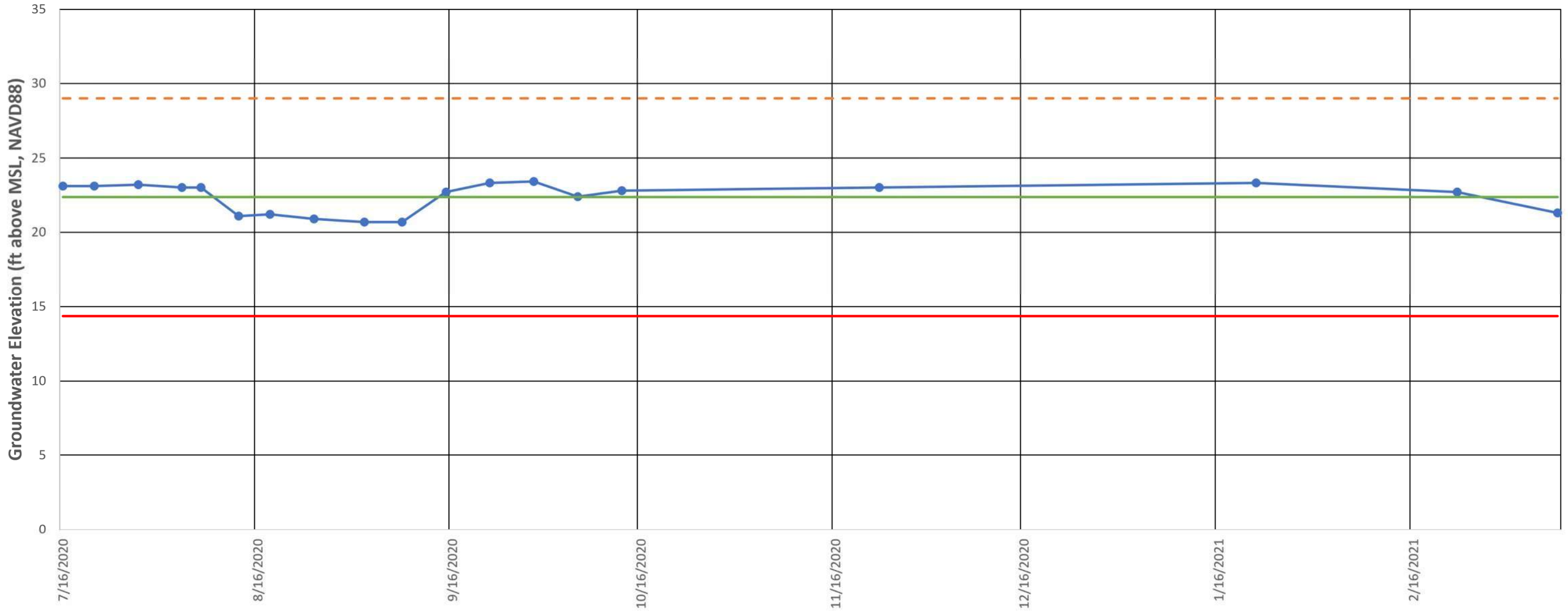

- Groundwater Level
- Ground Surface Elevation
- Measurable Objective
- Minimum Threshold

Operational Range: 8 ft
MT Method Selected: Minimum Operating Range

Site Code: 388869N1216445W002
SWN: N/A
Local ID: Ma-1
Other ID: N/A

Ground Surface Elevation: 29 NAVD88 ft
Depth: 140 ft bgs
Screen Interval - 1: 103 - 133 ft bgs
Screen Interval - 2: N/A - N/A ft bgs
Aquifer Zone: AZ-1

SR-1A

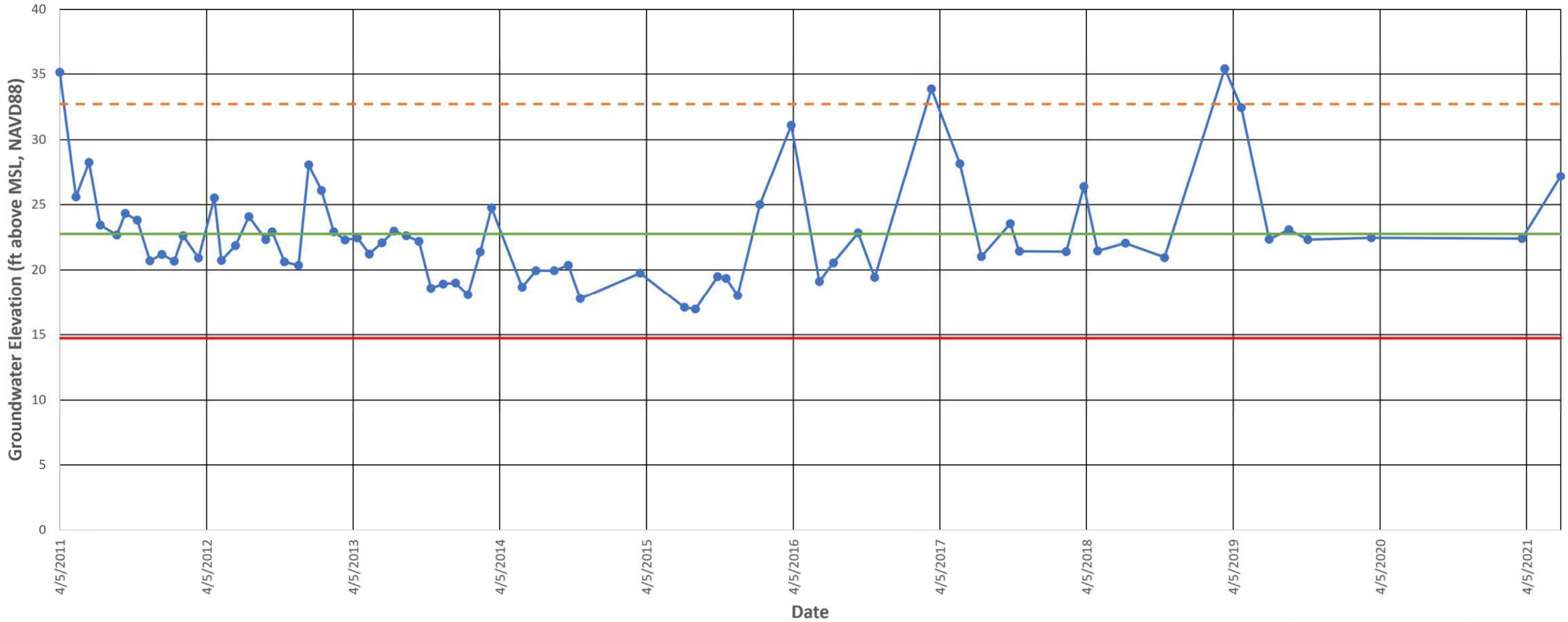

- Groundwater Level
- - - Ground Surface Elevation
- Measurable Objective
- Minimum Threshold

Operational Range: 8 ft
 MT Method Selected: Minimum Operating Range

Site Code: 388813N1217525W001
 SWN: 12N02E21Q001M
 Local ID: SR-1A
 Other ID: N/A

Ground Surface Elevation: 32.71 NAVD88 ft
 Depth: 68 ft bgs
 Screen Interval - 1: 54 - 64 ft bgs
 Screen Interval - 2: N/A - N/A ft bgs
 Aquifer Zone: AZ-1

Sutter County MW-3A

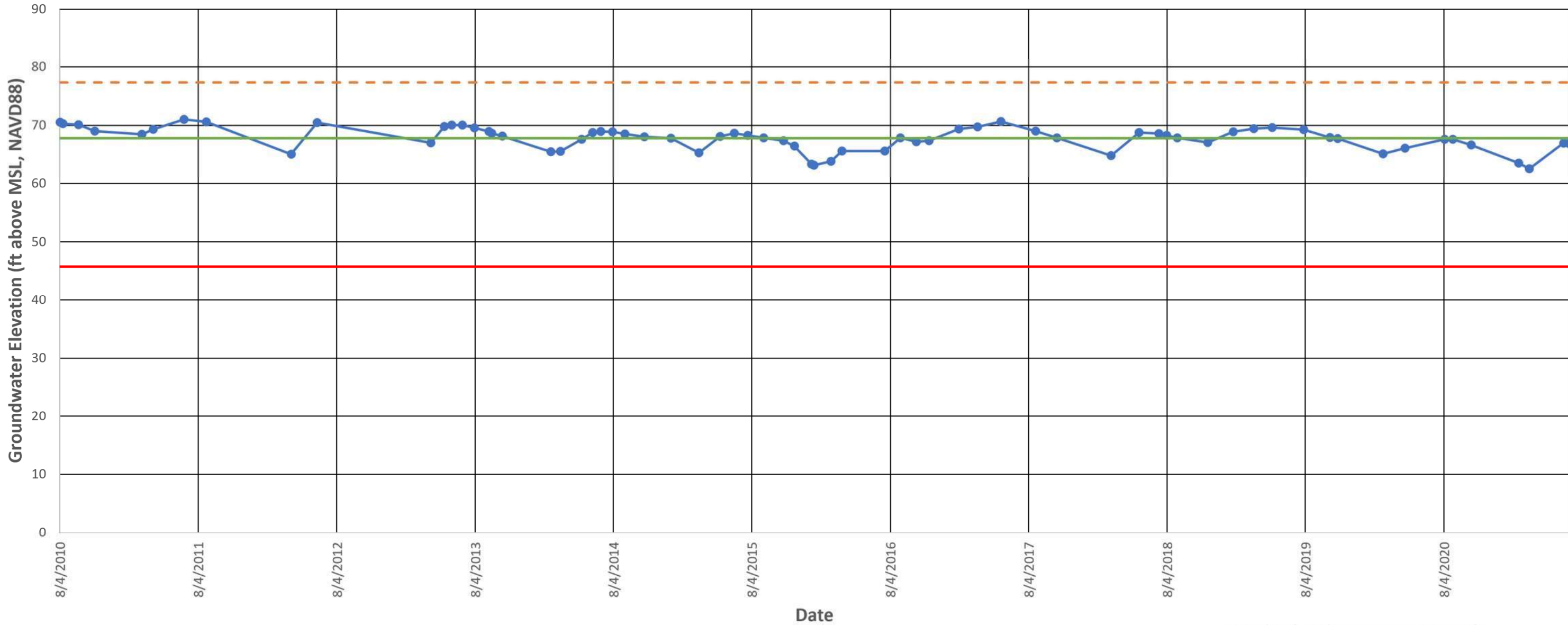

- Groundwater Level
- - - Ground Surface Elevation
- Measurable Objective
- Minimum Threshold

Operational Range: 22.02 ft
 MT Method Selected: 90% avg projected elevation with +50% ET

Site Code: 392394N1216509W001
 SWN: 16N03E17J001M
 Local ID: Sutter County MW-3A
 Other ID: N/A

Ground Surface Elevation: 77.35 NAVD88 ft
 Depth: 85 ft bgs
 Screen Interval - 1: 65 - 75 ft bgs
 Screen Interval - 2: N/A - N/A ft bgs
 Aquifer Zone: AZ-1

Feather River MW-1B

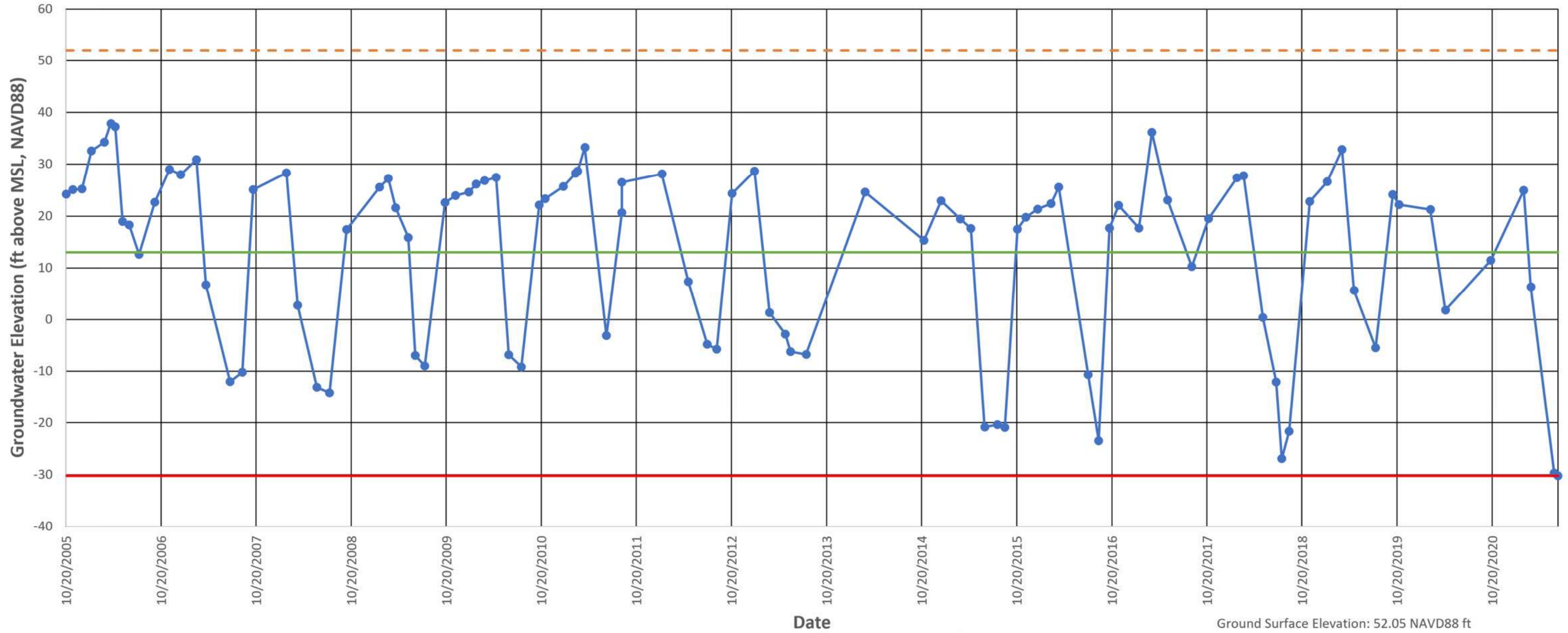

- Groundwater Level
- - - Ground Surface Elevation
- Measurable Objective
- Minimum Threshold

Operational Range: 43.19 ft
 MT Method Selected: Historic Low

Site Code: 390458N1216114W002
 SWN: 14N03E23D004M
 Local ID: Feather River MW-1B
 Other ID: N/A

Ground Surface Elevation: 52.05 NAVD88 ft
 Depth: 260 ft bgs
 Screen Interval - 1: 235 - 255 ft bgs
 Screen Interval - 2: N/A - N/A ft bgs
 Aquifer Zone: AZ-2

Sutter County MW-3B

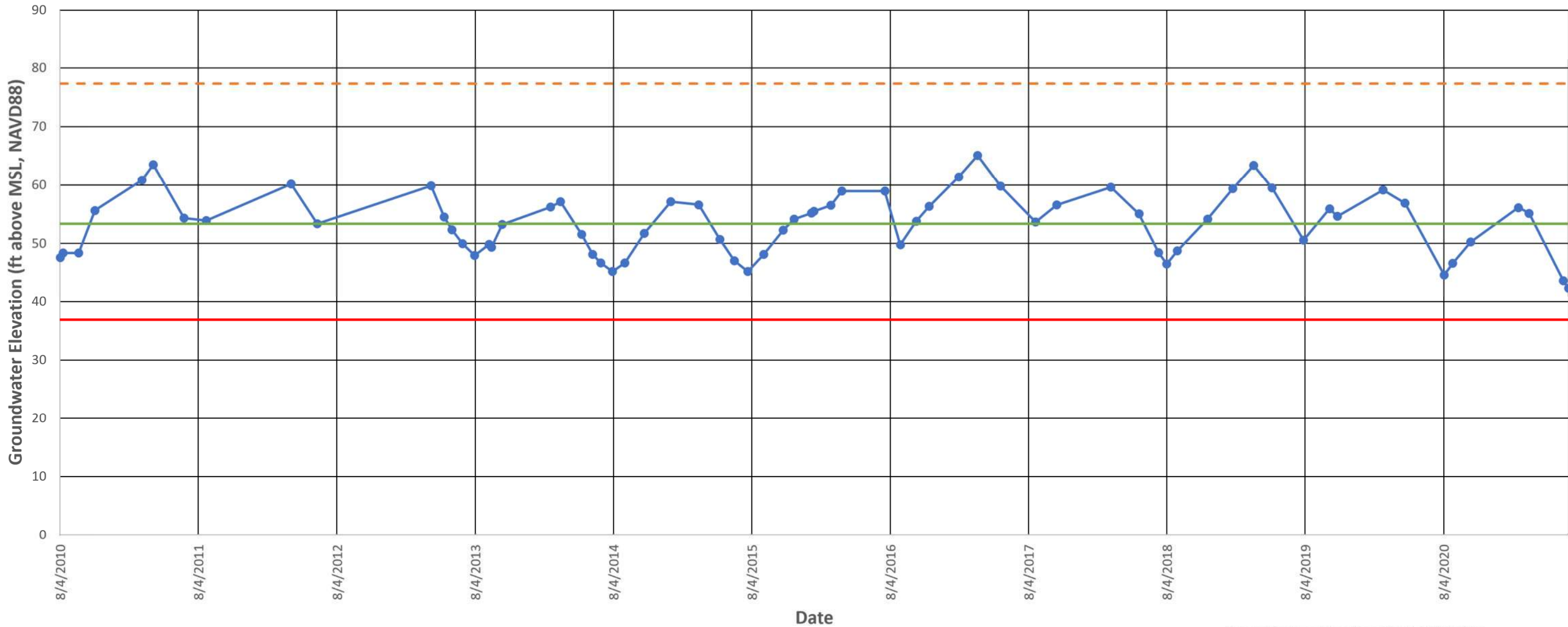

- Groundwater Level
- - - Ground Surface Elevation
- Measurable Objective
- Minimum Threshold

Operational Range: 16.5 ft
 MT Method Selected: Minimum Operating Range

Site Code: 392394N1216509W002
 SWN: 16N03E17J002M
 Local ID: Sutter County MW-3B
 Other ID: N/A

Ground Surface Elevation: 77.35 NAVD88 ft
 Depth: 315 ft bgs
 Screen Interval - 1: 285 - 305 ft bgs
 Screen Interval - 2: N/A - N/A ft bgs
 Aquifer Zone: AZ-2

Feather River MW-1C

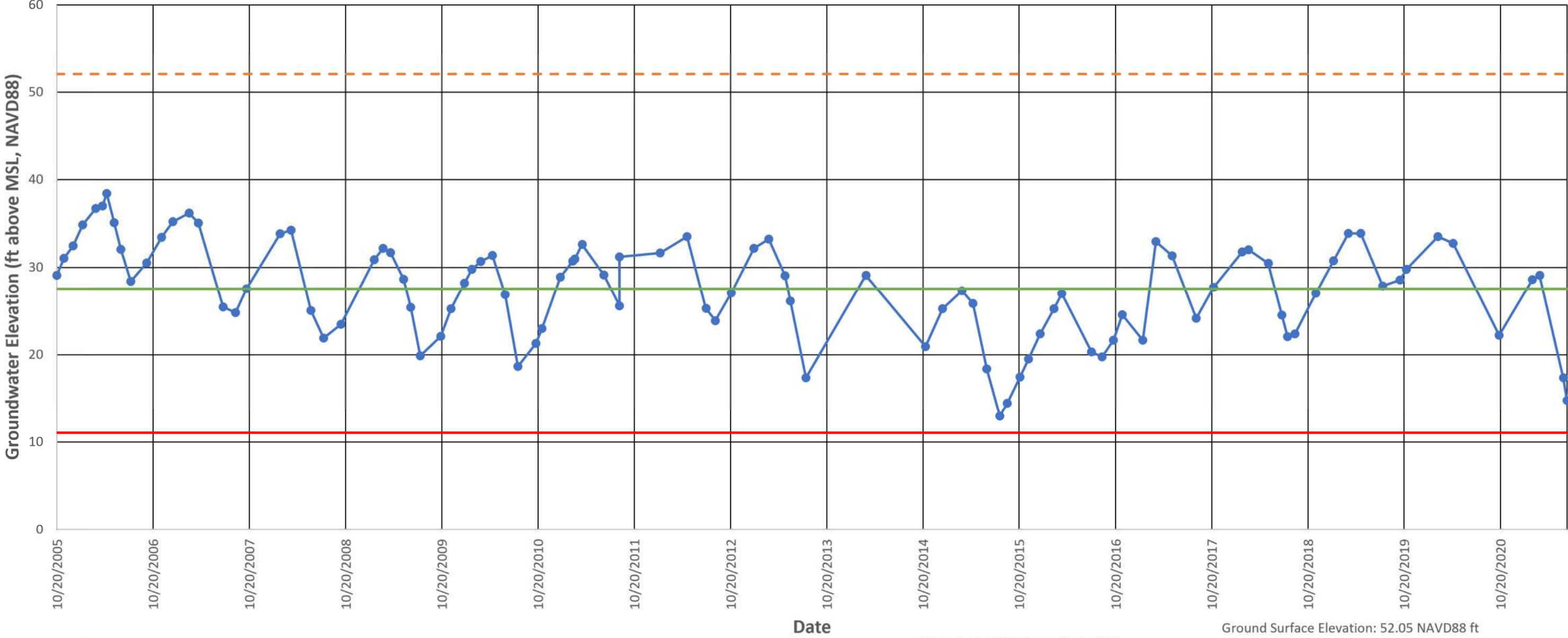

- Groundwater Level
- - - Ground Surface Elevation
- Measurable Objective
- Minimum Threshold

Operational Range: 16.5 ft
 MT Method Selected: Minimum Operating Range

Site Code: 390458N1216114W003
 SWN: 14N03E23D005M
 Local ID: Feather River MW-1C
 Other ID: N/A

Ground Surface Elevation: 52.05 NAVD88 ft
 Depth: 689 ft bgs
 Screen Interval - 1: 664 - 684 ft bgs
 Screen Interval - 2: N/A - N/A ft bgs
 Aquifer Zone: AZ-3

Feather River MW-1D

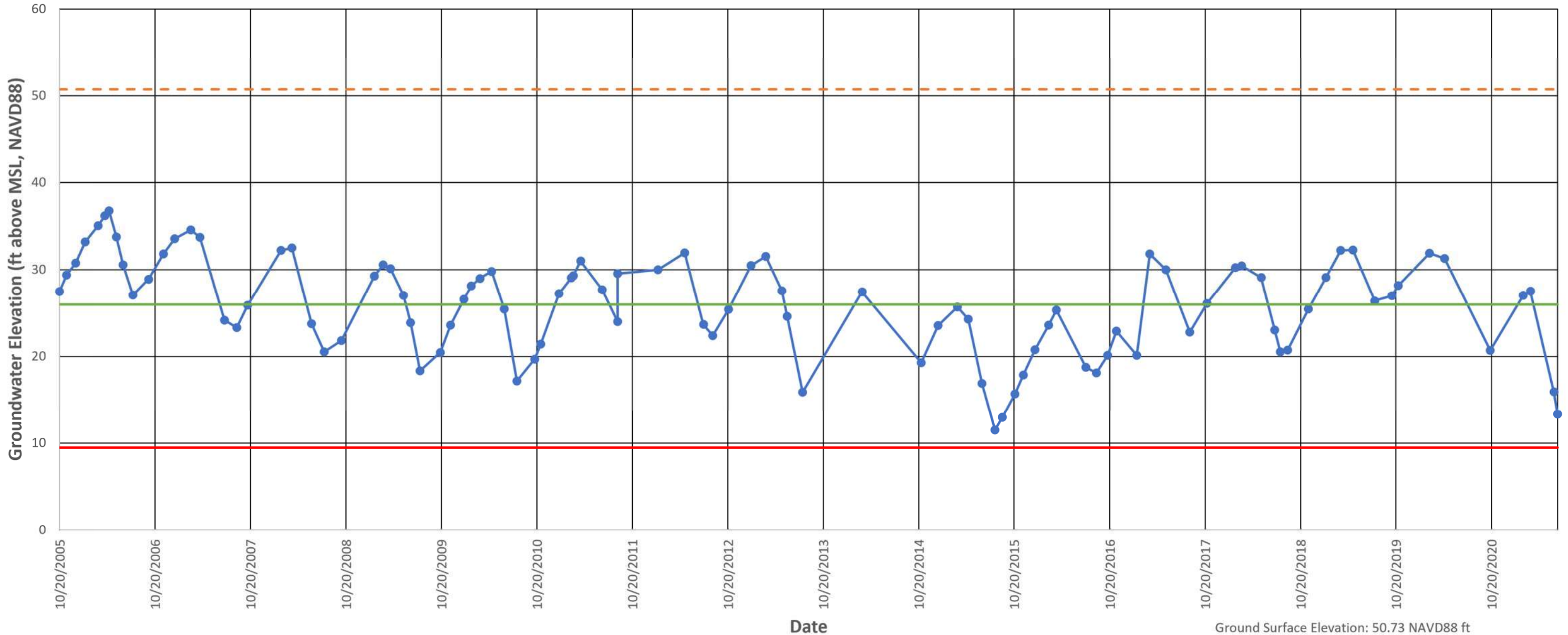

- Groundwater Level
- - - Ground Surface Elevation
- Measurable Objective
- Minimum Threshold

Operational Range: 16.5 ft
 MT Method Selected: Minimum Operating Range

Site Code: 390458N1216114W004
 SWN: 14N03E23D006M
 Local ID: Feather River MW-1D
 Other ID: N/A

Ground Surface Elevation: 50.73 NAVD88 ft
 Depth: 1021 ft bgs
 Screen Interval - 1: 996 - 1016 ft bgs
 Screen Interval - 2: N/A - N/A ft bgs
 Aquifer Zone: AZ-3

Sutter County MW-3C

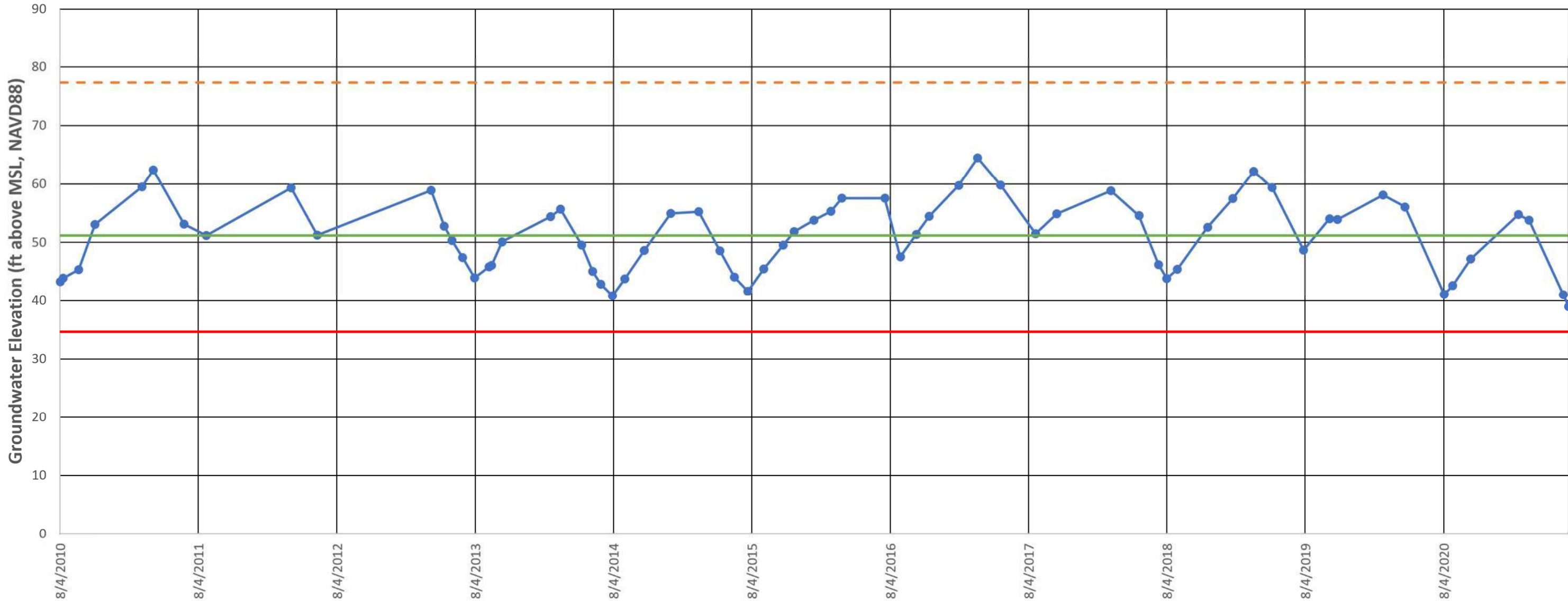

- Groundwater Level
- - - Ground Surface Elevation
- Measurable Objective
- Minimum Threshold

Operational Range: 16.5 ft
 MT Method Selected: Minimum Operating Range

Site Code: 392394N1216509W003
 SWN: 16N03E17J003M
 Local ID: Sutter County MW-3C
 Other ID: N/A

Ground Surface Elevation: 77.35 NAVD88 ft
 Depth: 430 ft bgs
 Screen Interval - 1: 400 - 420 ft bgs
 Screen Interval - 2: N/A - N/A ft bgs
 Aquifer Zone: AZ-3

Sutter County MW-3D

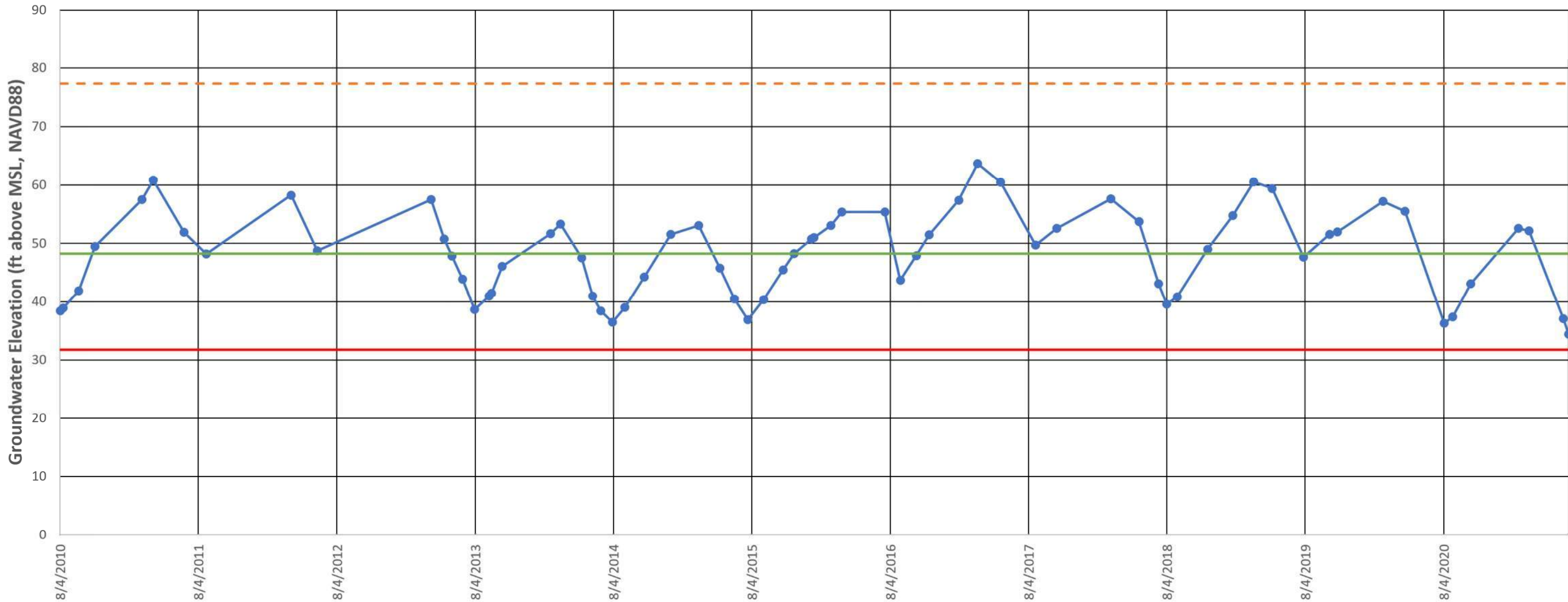

- Groundwater Level
- - - Ground Surface Elevation
- Measurable Objective
- Minimum Threshold

Operational Range: 16.5 ft
 MT Method Selected: Minimum Operating Range

Site Code: 392394N1216509W004
 SWN: 16N03E17J004M
 Local ID: Sutter County MW-3D
 Other ID: N/A

Ground Surface Elevation: 77.35 NAVD88 ft
 Depth: 615 ft bgs
 Screen Interval - 1: 595 - 605 ft bgs
 Screen Interval - 2: N/A - N/A ft bgs
 Aquifer Zone: AZ-3

Sutter County MW-3E

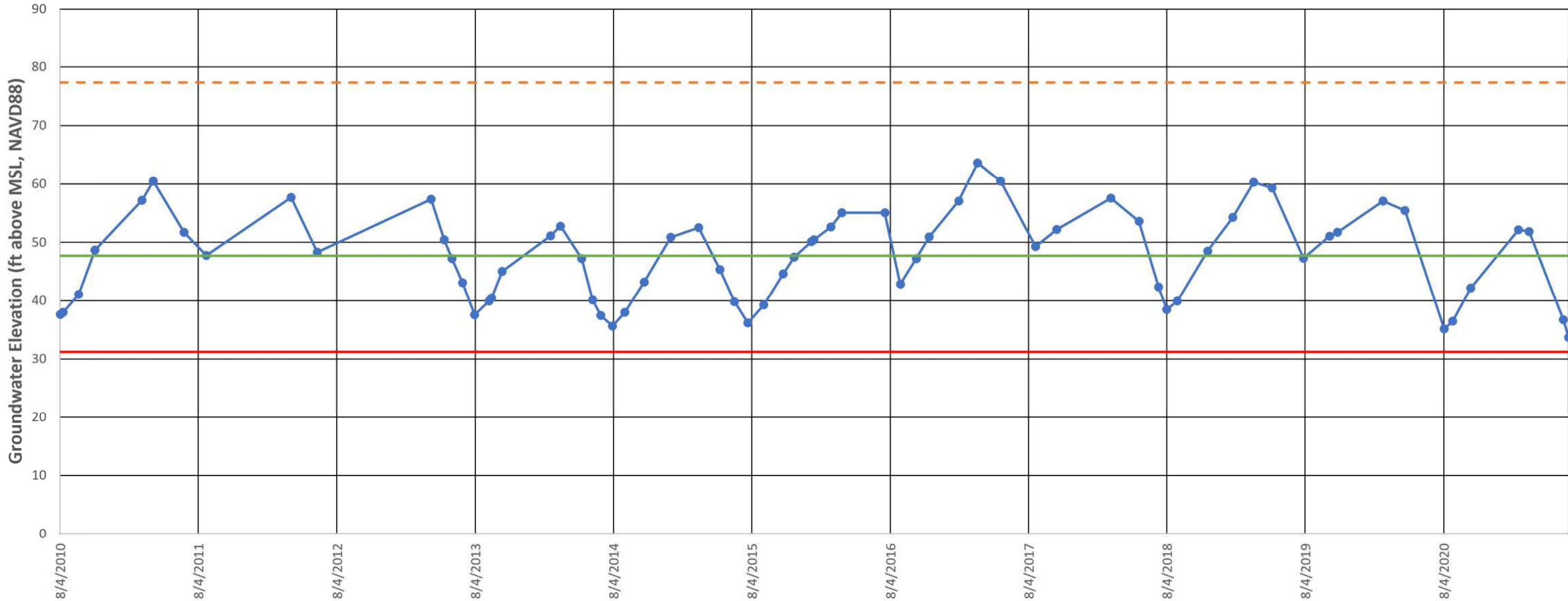

- Groundwater Level
- - - Ground Surface Elevation
- Measurable Objective
- Minimum Threshold

Operational Range: 16.5 ft
 MT Method Selected: Minimum Operating Range

Site Code: 392394N1216509W005
 SWN: 16N03E17J005M
 Local ID: Sutter County MW-3E
 Other ID: N/A

Ground Surface Elevation: 77.35 NAVD88 ft
 Depth: 785 ft bgs
 Screen Interval - 1: 765 - 785 ft bgs
 Screen Interval - 2: N/A - N/A ft bgs
 Aquifer Zone: AZ-3

Appendix 6-B
Sustainable Management Criteria for Chronic Lowering of
Groundwater Levels Methodology Technical Memorandum

This page intentionally left blank.

TECHNICAL MEMORANDUM

PREPARED BY: Leslie Dumas

DATE: August 16, 2021

RE: Sustainable Management Criteria for Chronic Lowering of Groundwater Levels

As required pursuant to the Groundwater Sustainability Plan (GSP) Emergency Regulations Article 5 *Plan Contents*, Subarticle 3 *Sustainable Management Criteria* (§ 354.22 through 354.30), Sustainable Management Criteria (SMC) are to be established for applicable sustainability indicators in a given groundwater basin. This memorandum was prepared to document the methods considered for identifying when undesirable results are occurring and for establishing the minimum thresholds (MTs) and measurable objectives (MO) for the chronic lowering of groundwater levels sustainability indicator for the Sutter Subbasin.

1. IDENTIFICATION OF UNDESIRABLE RESULTS

The Sustainable Groundwater Management Act (SGMA) defines sustainable groundwater management as “the management and use of groundwater in a manner that can be maintained during the planning and implementation horizon without causing undesirable results” (California Water Code Section 10721). Undesirable results statements describe the conditions at which, for each applicable sustainability indicator, significant and unreasonable negative impacts to beneficial uses and users are observed in the Subbasin. For the Sutter Subbasin, undesirable results for the chronic lowering of groundwater levels occur when MTs are exceeded in 25% or more of representative monitoring locations concurrently over two consecutive seasonal high water level measurements.

The identification of undesirable results for the chronic lowering of groundwater levels was developed through discussion and consensus among the Sutter Subbasin Groundwater Management Coordination Committee (SSGMCC) and subbasin stakeholders attending the SSGMCC meetings on July 8, 2021; July 22, 2021; and August 5, 2021. Input was also received from stakeholders during a public workshop held on August 11, 2021. The frequency portion of the undesirable results statement (groundwater levels below MTs for two consecutive seasonal high groundwater elevations) was selected for several reasons:

1. Statistically, one data point does not delineate a trend. Groundwater elevations naturally rise and fall in the Sutter Subbasin based on hydrologic year conditions, the timing of applied surface water and/or groundwater pumping, releases from upstream reservoirs, and the time of year relative to irrigation. Using the criterion of “...two consecutive seasonal high water level measurements” ensures the conditions are establishing a trend, and that the undesirable results are occurring at the beginning of a trend, thereby resulting in early corrective actions.
2. The use of seasonal high groundwater elevations was selected as, historically, groundwater levels in the Subbasin rebound after annual lows (typically occurring at the end of the year when irrigation use has ended the next year’s rainfall events have not yet begun). If the seasonal high groundwater levels decline over an extended period of time, this indicates a long-term downward trend that will need to be monitored and managed so as to not result in irreversible Subbasin impacts.
3. Subbasins in the Sacramento Valley are typically delineated by the rivers and other surface water courses. Subbasins adjoining the Sutter Subbasin are using a similar frequency (24 months) in identifying if undesirable results are occurring. Use of a similar frequency in the Sutter Subbasin facilitates data sharing,

comparison of conditions across the subbasin boundaries, and promotes the regional management of the larger Sacramento Valley Groundwater Basin.

The percentage of exceedance (25%) in representative monitoring wells was also selected as a result of the consensus among the SSGMCC members and subbasin stakeholders attending the SSGMCC meetings on July 8; July 22, 2021; and August 5, 2021. This percentage was selected in a fashion similar to that for the frequency. Specifically, selecting a higher percentage of MT exceedances (e.g., 50%) was thought to result in more extensive Subbasin impacts and therefore be harder to correct. Considering the percentage used by the adjoining subbasins was, again, thought to provide benefits in consistent data collecting and sharing and for facilitating the larger regional management of the Sacramento Valley Groundwater Basin. Finally, it was believed that 25% recognizes overlying land use and the ability to adapt to changes in water supply reliability as part of an adaptive management strategy to maintain Subbasin sustainability.

2. MEASURABLE OBJECTIVE

Measurable objectives are defined as specific, quantifiable goals for the maintenance or improvement of specified groundwater conditions that have been included a GSP to achieve the sustainability goal for the basin or subbasin. Based on the projected water budgets (including climate change) detailed in **Section 5.3** of the *Basin Setting* chapter of the Sutter Subbasin GSP, the Sutter Subbasin has been shown to be currently in a sustainable state and is projected to remain in a sustainable state. As such, measurable objectives have been formulated around the maintenance of current conditions and to be reflective of both past, current and future conditions.

Four potential methods were evaluated for establishing numerical measurable objectives at each representative monitoring location in the groundwater level monitoring network. These methods were:

- Average of measurements from water year (WY) 2015 to 2020
- Average of historic record
- Average of seasonal highs over historic record
- 10 feet below ground surface elevation

The average of measurements between WY 2015 and WY 2020 was considered as it represents both the last five years of records (containing both dry, wet and average hydrologic conditions) and is the methodology utilized by several of the adjoining groundwater subbasins to the Sutter Subbasin. The average groundwater level calculated over the historic record for each representative monitoring site was considered as it reflected a longer, more varied, hydrologic record and therefore can be considered to be more statistically representative of the Subbasin. The average of groundwater elevations over the period of seasonal high levels was considered as, similar to the average groundwater level, it reflects a longer, more varied hydrologic record, but it also reflects the Subbasin in its 'recovered' state. And finally, 10 feet below the ground surface elevation was considered as established in the Sutter Subbasin Alternative Plan.

The average of historic record was selected as the measurable objective methodology for the following reasons:

- The 10 feet below ground surface methodology appeared somewhat arbitrary and did not consider the modeled water budget results.
- The average of seasonal high groundwater levels over the historic record set a higher MO than the other two methodologies. While maintaining elevated groundwater levels is important, it is not necessarily reflective of the long-term variations in groundwater record and could result in an artificial need to maintain higher groundwater elevations long-term, limiting the beneficial use of groundwater in the Subbasin.

- The MO values produced by considering the average groundwater elevations versus just those recorded during the WY2015-2020 period of record were, for the most part, very similar.

As such, it was determined that using the entire historic record was a more statistically sound approach, and therefore, this was the method selected for establishing the MOs.

3. MINIMUM TRESHOLDS

Minimum thresholds are defined in the GSP Emergency Regulations as a numeric value for each sustainability indicator used to define undesirable results. For the Sutter Subbasin, several methods were evaluated for establishing the Subbasin MTs for declining groundwater levels. These methods were selected based the methods used by the adjoining subbasins and by those utilized in establishing MTs for several of the critically-overdrafted subbasins. Methods considered included:

- Thiessen polygons with consideration of the number of impacted domestic wells in each polygon
- Minimum saturated thickness required to maintain domestic and/or agricultural groundwater pumping
- Historic low at each representative well, based on available record
- Average projected groundwater elevations with 50% increase in evapotranspiration (ET)
- Operating range using proxy wells
- Minimum operating range by zone (Shallow/Aquifer Zone (AZ)-1 and AZ-2/AZ-3)

The results of the evaluation of each of these methods is described below.

3.1 Thiessen Polygons

Thiessen polygons are polygons generated around a set of points in a given space by assigning all locations in that space to the closest member of the point set. Any location in a Thiessen polygon is closer to the corresponding point inside it than to any other member of the point set. For this analysis, the Sutter Subbasin was subdivided into Thiessen polygons based on a selection of sample wells representing the point set (Figure 1). Domestic wells with available construction (including well depth and/or screen interval) and location information in the California Department of Water Resources¹ (DWR's) Well Completion Report Map Application were evaluated in each Thiessen polygon to determine the percentile of minimum domestic well depths within each polygon.

In each polygon, the 10th percentile of minimum domestic well depths (a reasonable reflection of the shallowest of the domestic wells) within the polygon was estimated. The resulting depths ranged between 36 and 129 feet deep throughout the Subbasin. These depths were then compared against the overall historical fluctuations in groundwater levels at the wells identified in Figure 1 – ranging between 30 and 140 feet.

This analysis indicates that historic groundwater elevation fluctuations are on the same order as the 10th percentile of minimum domestic well depths, indicating that the likelihood of the shallowest of domestic wells going dry due to Subbasin management is equivalent to the likelihood of those wells going dry due to natural hydrologic variations.

¹ DWR's Well Completion Report Map Application is available at <https://www.arcgis.com/apps/webappviewer/index.html?id=181078580a214c0986e2da28f8623b37>.

Figure 1: Sutter Subbasin Thiessen Polygons Example

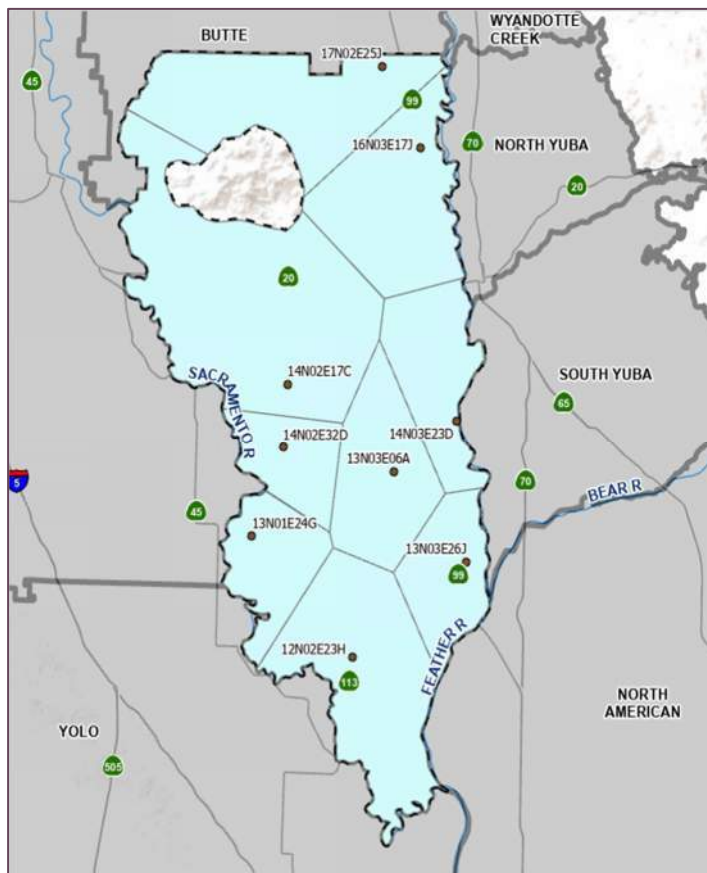

3.2 Minimum Saturated Thickness

As noted in the Santa Cruz Mid-County Groundwater Basin GSP (November 2019)¹, in determining minimum thresholds for chronic lowering of groundwater levels it is assumed that groundwater levels cannot go below a level which prevents overlying groundwater users from meeting their typical water demand. Overlying water demand is determined from land use and by the well use in the vicinity of the representative monitoring network wells. The saturated thickness of an aquifer is an important factor that can limit well yields, as when groundwater levels decline, the saturated thickness of the aquifer also decreases. In using this methodology to establish minimum thresholds, one evaluates the minimum saturated thickness that would need to be maintained such that the aquifer can produce sufficient water to the well to meet the minimum rate of pumping needed to meet typical demands.

Pump rates and aquifer properties control how much saturated aquifer thickness (distance between the bottom of the well and the groundwater level) is needed to meet water demands. Water demands by municipal wells are known as municipal agencies have detailed records of each well’s pump capacity and volumes pumped. Private domestic and agricultural well users generally do not have this information, and therefore assumptions are made to estimate their water usage. For evaluating the use of minimum saturated thickness as a method for establishing minimum thresholds

¹ Available at: <https://sgma.water.ca.gov/portal/gsp/preview/11>.

in the Sutter Subbasin, the methodology utilized by the Santa Cruz Mid-County Groundwater Basin GSP was conducted and the results evaluated against typical domestic and agricultural well construction in the Sutter Subbasin.

Similar to the Santa Cruz Mid-County Groundwater Basin GSP analysis, average pumping rates of 15 gallons per minute (gpm) were assumed for domestic well users. For agricultural wells, the estimated required pumping capacity was assumed to be 250 gpm. These values were used, along with assumed aquifer properties, in a spreadsheet tool developed by the Kansas Geological Survey (Brookfield, 2016)¹ to estimate a theoretical minimum saturated thickness (MST) at representative locations around the Sutter Subbasin required to meet the overlying water demand. The tool considers well efficiency, nearby pumping wells, and drawdown in the well due to pumping at a given rate.

To consider uncertainties in the MST estimation, a 20% safety factor was added to the MST obtained from the spreadsheet tool, similar to the method used in the Santa Cruz Mid-County Groundwater Basin GSP. It is also assumed that a well pump can be placed no deeper than 20 feet from the bottom of the well to prevent the pump from being damaged by settled sediment in the bottom of the well. This is the typical depth well pumps are set in domestic wells. To account for this, a further 20 feet was added to the estimated MST, as shown in Figure 2. The resultant adjusted MST was then considered to be the minimum thickness of the saturated aquifer that is needed for overlying groundwater users to meet their typical demand. In many areas of the Sutter Subbasin, there are two overlying uses, such as agricultural and domestic, or municipal and domestic. For these cases, the adjusted MST of the use type that results in the shallowest groundwater level is used. Further, as a conservative measure, the approach assumed that the representative monitoring location has a depth equal to the shallowest nearby well screened. This results in a shallower groundwater elevation than if the actual depth of the representative monitoring location is used (if it is deeper than nearby wells).

Using the method described above resulted in an adjusted MST of 30 feet. Adding the 20-foot pump depth allowance results in a conservative adjusted MST of 50 feet. Based on construction information for identified wells in the shallow and upper (AZ1) aquifer zones in the Subbasin, domestic and shallow production wells in the upper portions of the principal aquifer range in depth from 30 to 150 feet.

While this methodology was appropriate for use in the Santa Cruz Mid-County Groundwater Basin GSP area (due to supply wells typically being of much greater depth than in the Sutter Subbasin), application of this methodology to the shallowest of wells in the Subbasin is not reasonable due to the shallow groundwater levels, and therefore shallow domestic wells, in the Sutter Subbasin and would result in minimum thresholds at or near the total depth of the well in many locations.

¹ Brookfield, Andrea. 2016. *Minimum Saturated Thickness Calculator*. Kansas Geological Survey Open-File Report 2016-3. February as viewed at http://www.kgs.ku.edu/Hydro/Publications/2016/OFR16_03/index.html on June 28, 2021.

Figure 2: Schematic of Minimum Saturated Thickness Approach

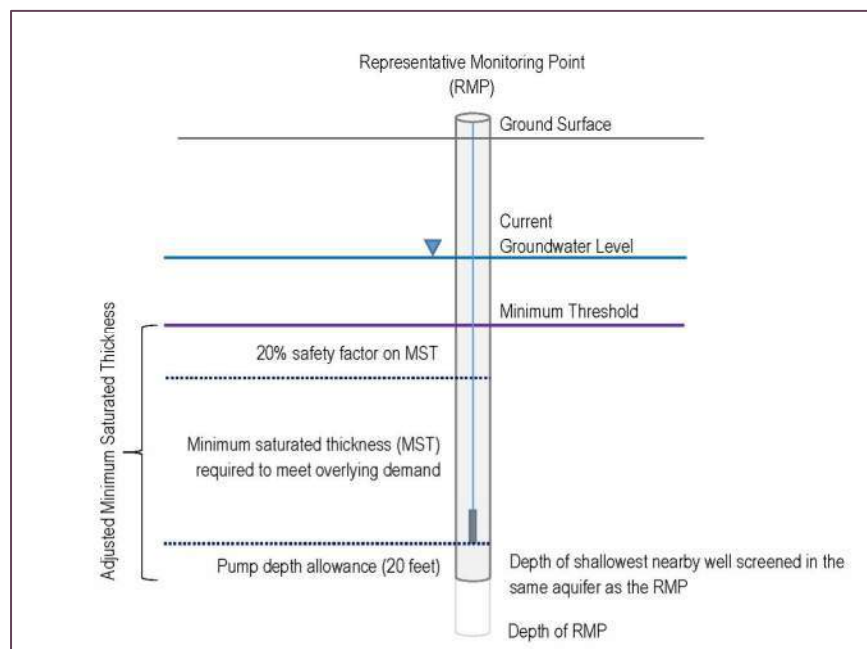

3.3 Historic Low

In the Sutter Subbasin, groundwater levels have been sustainable over the available historic record where the aquifer has been shown to rebound during all water year types following the irrigation season, returning to pre-pumping levels on a seasonal basis (as discussed in further detail in **Section 5.2** of the *Basin Setting* chapter of the Sutter Subbasin GSP). Therefore, setting the MT as the historic low of the available record at each representative monitoring location was determined to be a viable methodology to avoid undesirable results.

3.4 Average Projected Condition with Increased Evapotranspiration

Sustainable yield is defined as the maximum volume of water that can be removed from a basin or subbasin without encountering undesirable results. Sustainable yield for the Sutter Subbasin was estimated using the C2VSimFG-Sutter integrated flow model by artificially increasing evapotranspiration (ET) rates in model elements overlying the Sutter Subbasin to induce additional groundwater pumping to meet overlying land use demands. In estimating sustainable yield, ET rates were increased by 10%, 15%, 20%, 50%, 75% and 100%. The resultant model results were then evaluated to determine the point at which undesirable results would occur relative to change in groundwater storage and interconnected surface water. Specifically, undesirable results were assumed to occur when:

- Change in storage reaches ~0 AF; or
- Rivers change from gaining to losing

In the simulations, change in storage went from positive to negative (or increasing to decreasing) at a 20% increase in ET rates, and the rivers went from gaining to losing at a 50% increase in ET. Groundwater elevations at select locations in the Subbasin under these changed conditions were compared against the projected water budget conditions in Figure 3.

Figure 3: Selected C2VSimFG-Sutter Projected Conditions Modeled Results with Increased ET

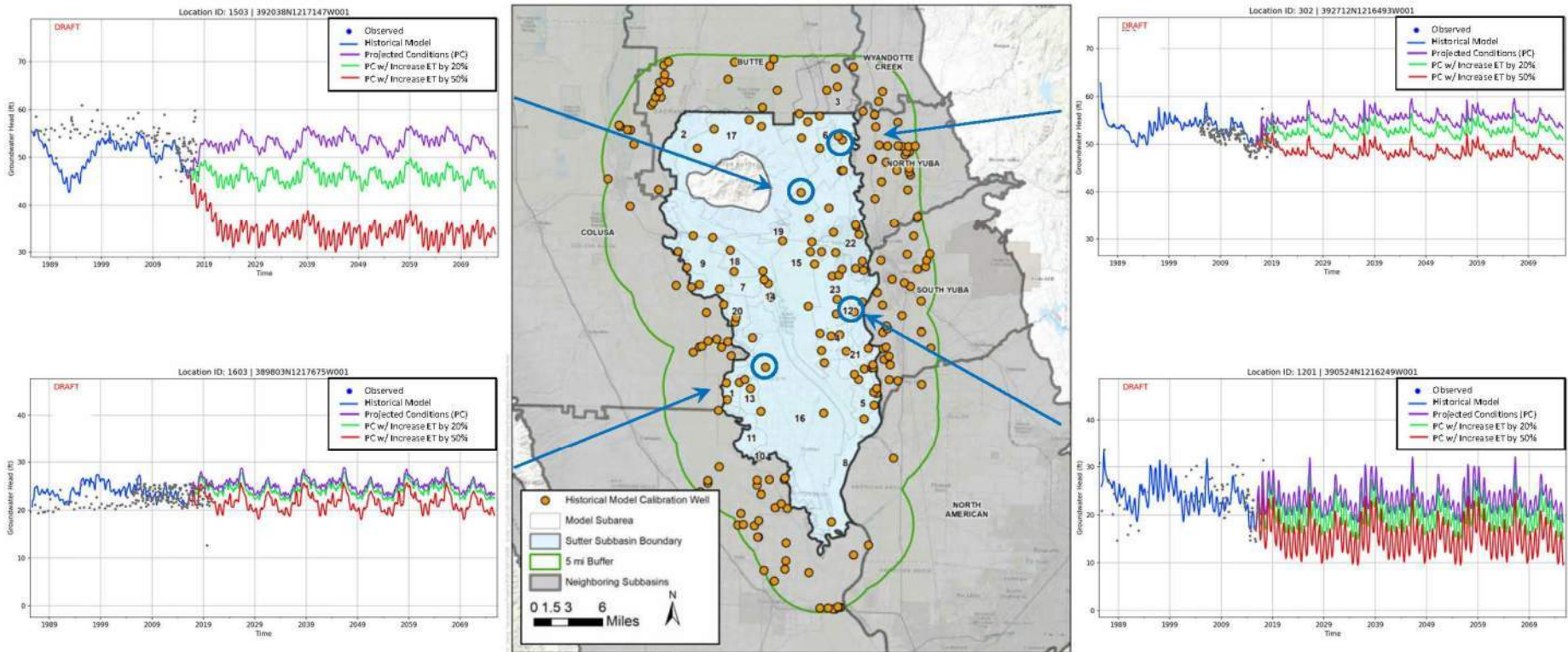

This page intentionally left blank.

Given the large volume of groundwater in storage in the Sutter Subbasin (approximately 49 million acre-feet), change in storage is not a predominant factor in the overall management of the Subbasin; rather, groundwater elevations are the primary controlling factor. Based on model results observed in preparing the projected water budgets with and without climate change factors, it appears that the two rivers surrounding the Subbasin (Sacramento and Feather Rivers) act similar to a regulating reservoir, feeding water into the Subbasin as groundwater levels are lowered through natural fluctuations or groundwater pumping. As such, impacts to these rivers are of greater concern than changes in groundwater in storage. Therefore, establishing minimum thresholds utilizing this method (assuming a percentage of groundwater levels under sustainable yield estimates impacting interconnected surface waters) was selected as a viable option for the Sutter Subbasin to avoid undesirable results. To be conservative, it was assumed that the minimum threshold groundwater levels at representative monitoring locations around the Subbasin would be set a 90% of the average simulated groundwater levels when ET values were increased by 50%. For some representative wells in the Sutter Subbasin, this method was selected to provide additional operating range while avoiding undesirable results where the average simulated groundwater level was deeper than the historic low at the that well.

3.5 Operating Range Using Proxy Wells

Minimum thresholds and measurable objectives were plotted on hydrographs at representative monitoring locations following completion of the assessment of the first four methodologies for establishing MTs, as described in **Sections 3.1 through 3.4** of this TM. The resulting operating range (the difference between the MO and MT at any given location) varied considerable from around 3 feet to more than 100 feet. Concern was expressed for those hydrographs with the smaller (less than 5 feet) operating range, especially as many of these locations had minimal data. Specifically, there was concern that the historical record of groundwater levels at those locations did not include the lowest groundwater level that may have occurred, and as a result, the operating range at those locations was not reflective of the ‘available’ operating range when the prior methodologies were applied. These small operating ranges may prevent the full beneficial use of groundwater by all users in the Sutter Subbasin before undesirable results are observed.

To address this concern, the Subbasin was subdivided into polygons in a manner similar to that used for domestic well depth (**Section 3.1** of this TM), and the operating ranges of representative monitoring wells in those polygons considered in establishing the use of proxy ranges for wells with smaller ranges. This analysis did not, however, yield useful results due to the lack of hydrographs available, and this method was therefore not considered going forward.

3.6 Minimum Operating Range by Zone

Similar to the prior method of using ‘proxy’ operating ranges for those representative monitoring locations with smaller data sets, the use of a minimum average operating range by aquifer zone was considered. Specifically, the operating ranges calculated through the use of the historic low and average projected condition with increased ET (**Sections 3.3 and 3.4** of this TM) methodologies considered for MTs were averaged across the aquifer zones. Calculated operating ranges for the Shallow AZ and AZ-1 were averaged, as were those for AZ-2 and AZ-3. These zones were combined as such to increase the data set over which the mean was estimated, while recognizing that the Shallow AZ and AZ-1 are reflective of shallow domestic wells, groundwater dependent ecosystems and interconnected surface waters, while AZ-2 and AZ-3 are reflective of larger and deeper municipal and agricultural production wells.

Based on this analysis, the minimum operating range for representative monitoring wells screened in the Shallow AZ and AZ-1 would be 8.0 feet, while that for wells screened in AZ-2 and AZ-3 is 16.5 feet. Application of this methodology as one of the alternatives in setting MTs at representative monitoring locations was considered valid as it reduced impacts of limited data sets in calculating the operating ranges at representative monitoring locations while still providing a technical basis for those estimations (as other methodologies were applied in the calculation of operating ranges used to estimate the average by zone).

4. SUMMARY

The following definitions and methodologies were selected for establishing numeric minimum thresholds and measurable objectives for representative monitoring wells in the groundwater level monitoring network based on the analyses documented above, discussions by the SSGMCC members and attending subbasin stakeholders at public meetings, and public feedback received during presentation of the sustainable management criteria at the August 11, 2021 public workshop.

Definition of Undesirable Results: Groundwater elevations dropping below the minimum threshold criteria at 25% of representative monitoring locations concurrently over two consecutive seasonal high water level measurements resulting in shallow domestic wells going dry in the same general areas as the representative monitoring points in violation, higher pumping costs, and/or the need to modify wells in those areas to obtain groundwater.

Identification of the Occurrence of Undesirable Results: 25% or more of representative monitoring locations exceeding minimum thresholds concurrently over two consecutive seasonal high water level measurements.

Measurable Objectives: Average groundwater level over each wells' historic record.

Minimum Thresholds: Deeper value of the maximum (deepest) historic groundwater level measurement, 90% of the average groundwater level simulated assuming sustainable yield with ET rates increased by 50%, or the average operating range by aquifer zone (8.0 feet for representative monitoring wells screened in the Shallow AZ and AZ-1; 16.5 feet for representative monitoring wells screened in AZ-2 or AZ-3).

Appendix 7-A
Sutter Subbasin GSP Projects and Management Actions
Matrix

This page intentionally left blank.

Introduction

Projects and management actions (PMAs) are included in the Sutter Subbasin Groundwater Sustainability Plan (GSP) to maintain sustainable groundwater conditions in the Sutter Subbasin. PMAs are categorized and presented in this appendix as follows:

- **Ongoing and Planned Projects and Management Actions** are PMAs that the GSAs or other project proponents are planning to implement or are currently implementing in the Sutter Subbasin. In accordance with 23 CCR §354.44(a), These are PMAs that will support ongoing sustainability and adapt to potential future changes in Subbasin conditions.
- **Other Projects and Management Actions to be Implemented as Needed** are PMAs that will be implemented “as needed,” depending on funding, interest among stakeholders, and changes in future groundwater conditions in the Sutter Subbasin. These PMAs may have been studied by the project proponent or in earlier regional water planning documents, but most project design, cost estimates, and planning work have yet to be completed, and would only be initiated if the project is eventually triggered for implementation as a result of continued monitoring of groundwater conditions.
- **Projects and Management Actions to Address Data Gaps** are PMAs that have been identified to address data gaps in the Sutter Subbasin. These PMAs generally include studies, surveys, and other monitoring efforts targeted to address data gaps in the hydrogeologic conceptual model, monitoring network, and other components of the Sutter Subbasin GSP.

The compilation of PMAs presented in this appendix are designed to support the long-term sustainability of groundwater resources of the Sutter Subbasin. The information currently available for each of these PMAs is provided in Tables 1 through 6 below. These tables summarize the following information:

- Table 1. Brief Description of all Projects and Management Actions
- Table 2. Project Type, Proponent, and Location for all Projects and Management Actions.
- Table 3. Implementation Criteria, Notice Process, Permitting and Regulatory Process, and Timeline for all Projects and Management Actions.
- Table 4. Anticipated Benefits of all Projects and Management Actions.
- Table 5. Benefit Evaluation and Water Source for all Projects and Management Actions.
- Table 6. Legal Authority Requirements, Estimated Cost, and Potential Funding Sources for all Projects and Management Actions.

The fields in these tables have been designed to meet the requirements for PMAs as described in the California Code of Regulations (CCR); when applicable, a reference to a specific location in the GSP regulations is provided as the first row of each table.

This page intentionally left blank.

Sutter Subbasin Groundwater Sustainability Plan

Table 1. Brief Description of all Projects and Management Actions.

23 CCR § 354.44		23 CCR §354.44(a)
Project/ Management Action Name	Proponent	Brief Project Description
Ongoing and Planned Projects and Management Actions		
System Modernization	Butte WD	<p>This project is part of District's comprehensive plan to enhance water management developed as part of the FRRAWMP. This project will conserve water through infrastructure modernization improvements that will result in reduced operational spillage and reduced farm deliveries through increased efficiency. Modernization improvements to District infrastructure will include:</p> <ol style="list-style-type: none"> 1. Improvements at canal headings to improve water level control, flow control, flow measurement, SCADA, and automation measurement 2. Improvements at customer delivery turnouts to improve delivery flexibility and steadiness <p>This project is expected to increase water supply and supply reliability, delivery flexibility, and/or instream flow; improve water quality.</p>
System Modernization	Sutter Extension WD	<p>This project is part of District's comprehensive plan to enhance water management developed as part of the FRRAWMP. This project will conserve water through infrastructure modernization improvements that will result in reduced operational spillage and reduced farm deliveries through increased efficiency. Modernization improvements to District infrastructure will include:</p> <ol style="list-style-type: none"> 1. Improvements at canal headings 2. Improvements to upstream water level control 3. Improvements to spill structures <p>Real-time monitoring will be implemented through the establishment of a District Supervisory Control and Data Acquisition (SCADA) system. This project is expected to increase water supply and supply reliability, delivery flexibility, and/or instream flow; improve water quality, and conserve energy</p>
Boundary Flow and Primary Spill Measurement and Drainage Recovery	Butte WD	<p>This project is part of District's comprehensive plan to enhance water management developed as part of the FRRAWMP. This project will aid the District in conserving water by allowing operational spillage and flow measurement and real time monitoring at primary operational spills. Real-time monitoring will be implemented through the establishment of a District Supervisory Control and Data Acquisition (SCADA) system. This project is expected to increase water supply and supply reliability, delivery flexibility, and/or instream flow; improve water quality.</p>
Boundary Flow and Primary Spill Measurement and Drainage Recovery	Sutter Extension WD	<p>This project is part of District's comprehensive plan to enhance water management developed as part of the FRRAWMP. This project will aid the District in conserving water through flow measurement and real time monitoring at primary operational spills, and tailwater recovery for reuse of operational spillage. This project is expected to increase water supply and supply reliability, delivery flexibility, and/or instream flow; improve water quality, and conserve energy</p>

23 CCR § 354.44		23 CCR §354.44(a)
Project/ Management Action Name	Proponent	Brief Project Description
Dual Source Irrigation Systems	Butte WD	This project will incentivize the use of irrigation systems capable of using both surface water and groundwater, allowing irrigators to take water of either source when available
Multi-benefit recharge	Multi-agencies/GSAs	The Nature Conservancy (TNC) has prepared guidance to assist GSAs in planning on-farm, multi-benefit groundwater recharge programs. A multi-benefit recharge program will provide groundwater recharge through normal farming operations while also providing critical wetland habitat for waterbirds migrating along the Pacific Flyway. Fields with soil and cropping conditions conducive to groundwater recharge will be flooded and maintained with shallow depths. Water will be sourced from existing water rights contracts, depending on availability. GSAs may also consider financial compensation for participating, offsetting field preparation, irrigation, and water costs.
Grower Education Relating to On-Farm Practices for Sustainable Groundwater Management	Multi-agencies/GSAs	Grower education on topics that support groundwater sustainability is proposed for all areas of Sutter subbasin. Grower education would be accomplished through onsite irrigation system evaluations, workshop education, providing irrigation water management assistance, and promoting the use of irrigation scheduling with irrigators.
Installation of additional shallow groundwater monitoring wells	Multi-agencies/GSAs	Installing 10 shallow monitoring wells in key areas of the Subbasin to support monitoring of interconnected surface water and groundwater dependent ecosystems
Other Projects and Management Actions to be Implemented as Needed		
Removal of Bottlenecks on the Sutter-Butte Main Canal	Butte WD	This project is part of District's comprehensive plan to enhance water management developed as part of the FRRAWMP. This project is expected to increase refuge water supply, supply reliability, and delivery flexibility.
Improved Delivery Service to Pressurized Irrigation Systems	Butte WD	This project is part of District's comprehensive plan to enhance water management developed as part of the FRRAWMP. Elements include a Sunset to Webster pipeline conversion, and improved turnout configuration and debris management. This project is expected to improve air quality, conserve energy, and increase water supply and supply reliability.
Wetlands Water Management	Central Valley Joint Venture (CVJV; specific effort by Sutter Extension WD)	<p>The CVJV implementation plan (1990, updated in 2006 and 2020) has identified conservation objectives for waterfowl, shorebirds, waterbirds, and riparian songbirds:</p> <ol style="list-style-type: none"> 1. Protect 80,000 additional wetland acres through land acquisitions, 2. Secure firm, timely, high quality water supplies for refuges and wildlife areas, 3. Secure CVP power to support wetlands management, 4. Increase wetlands by 120,000 acres, 5. Enhance habitat on 292,000 acres of public and private lands, 6. Enhance waterfowl habitat on 443,000 acres of agricultural lands, 7. Identification and evaluation of water needs and challenges

23 CCR § 354.44		23 CCR §354.44(a)
Project/ Management Action Name	Proponent	Brief Project Description
		<p>The CVPIA Refuge Water Supply Program has resulted in the construction of new facilities in the region and led to the development of agreements for districts to provide firm water supplies to certain refuges. Specifically, SEWD provides water to Sutter National Wildlife Refuge.</p> <p>In the Butte and Sutter subbasins, as described by CVJV (2006), as of 2003:</p> <ol style="list-style-type: none"> 1. 10,835 acres of wetlands had been protected through acquisition of land and easements (103 percent of basin-specific goals) 2. 18,553 acres of wetlands were restored (48 percent of goals) 3. 132,662 acres of enhanced waterfowl habitat on agricultural lands was achieved (94 percent of goals)
Advanced Treatment and Water Recycling	City of Yuba City	<p>The City is currently conducting a Recycled Water Facilities Plan to analyze the possibility of implementing advanced treatment and water recycling at the City's Wastewater Treatment Facility (WWTF). The resultant recycled water may be used for multiple purposes, including refuge water supply, landscape irrigation, a recycled water fill station, and possibly a future groundwater recharge project. Once the facilities plan is complete, the City would like to start design and construction of advanced treatment facilities at the WWTF and distribution pipelines to provide recycled water for beneficial use.</p>
Aquifer Storage & Recovery and Second Well	City of Yuba City	<p>There are currently three monitoring wells in service being used to study the feasibility of an aquifer storage recovery (ASR) well. If the project appears feasible, the City would like to construct an ASR (aquifer storage recovery) well to bank water in wet periods and provide additional groundwater supplies in dry periods. If the study determines that an ASR well is not feasible, the City would like to install an extraction well instead in order to provide additional groundwater supplies during dry periods. As soon as the feasibility study is completed and the preferred option determined (installation of an ASR well or an extraction well), the City would like to proceed with the proposed project. Once implemented (and assuming an ASR well is feasible), the City would be able to store (or bank) water from its contract allocated water in the winter months for use in the summer months.</p>
Backwash Recovery	City of Yuba City	<p>This project would recover approximately 0.42 million gallons per day (MGD) (or 475 acre feet per year (AF/yr)) of backwash water for treatment and distribution which would reduce the amount of water being diverted from the Feather River for supply by an equivalent amount.</p>
Electrical SCADA and Telemetry	City of Yuba City	<p>Current SCADA and telemetry for the water treatment plant and distribution system in the City of Yuba City are approximately 20 years old and nearly obsolete. Updating the systems would help the City monitor, manage data and control processes more effectively and would improve management of local water supplies.</p>
Groundwater Well Rehabilitation	City of Yuba City	<p>In 2002, the City of Yuba City purchased Hillcrest Water Co., a private water company that operated a groundwater system. The groundwater produced by the Hillcrest wells requires treatment in order to</p>

23 CCR § 354.44		23 CCR §354.44(a)
Project/ Management Action Name	Proponent	Brief Project Description
		meet drinking water standards. Most of the Hillcrest wells have been abandoned. The City is investigating the possibility of rehabilitating three Hillcrest wells and installing treatment facilities to provide emergency groundwater sources to supplement surface water supplies in low-water years.
New Outfall Diffuser	City of Yuba City	The Central Valley Regional Water Resources Control Board requires the City to construct a new effluent discharge outfall into the Feather River. Therefore, to regain the ability to discharge to the river under all river flows, a new outfall diffuser will be constructed in a more stable location. This will allow the treated effluent to be discharged to the river year-round, which would add operational flexibility at the treatment plant and, when in use, the outfall will result in approximately 6,600 AF of treated effluent being placed back into the Feather River where the flow will be used to support aquatic and riparian beneficial uses.
Replacement of Sewer Mains	City of Yuba City	This project will replace old and deteriorated sewer lines throughout the City to reduce the potential of sanitary sewer overflows (SSOs), and associated water quality impacts, that are caused by factors that are difficult to address through sewer cleaning or root treatment, and to reduce direct groundwater quality impacts resulting from leaking sewer lines.
Replacement of Water Distribution Mains	City of Yuba City	Some parts of the water distribution system are in critical condition, close to reaching their end of service life and in need of replacement. This system upgrade program would allow Yuba City to more effectively control water supply losses due to system leakage. Reducing groundwater pumping because of reduced losses.
Feather River Pump Station Fish Screen Feasibility Study	Garden Highway Mutual Water Company	The Feasibility Study will analyze the three following potential fish screen alternatives for Garden Highway Mutual Water Company's (GHMWC) Feather River surface water diversion: (1) fish screen at the existing intake pumps; (2) cone screen(s) with a berm at the mouth of the intake channel; (3) a closed pipeline connected to intake pumps and extending to the mouth of the intake channel with a screen at the river end of the pipeline. The Feasibility Study will also analyze the following two non-screen diversion alternatives: (1) point of diversion located at deeper part of the Feather River, and (2) a shallow well field to pump river underflow. These analyses will include an assessment of the engineering feasibility of each alternative, and the estimated costs of construction, as well as the annual and long-term maintenance requirements and costs.
Rice field infiltration study to promote FloodMAR projects	Multi-agencies/GSAs	This project would determine the feasibility and estimate the amount of infiltration a flood managed aquifer recharge (FloodMAR) project could provide from a rice field to increase direct recharge in the Subbasin
Installation of fish screens at Sutter Bypass pumping plants	Multi-agencies/GSAs	This project involves installation of fish screens to prevent entrainment of endangered juvenile salmonids and other fish species. Implementation of this project and others implemented prior to 2014 has resulted in a ten-fold increase in spring-run salmon and steelhead, and a three-fold increase in fall-run fish.

23 CCR § 354.44		23 CCR §354.44(a)
Project/ Management Action Name	Proponent	Brief Project Description
Improved Service to Pressurized Irrigation Systems	Sutter Extension WD	This project is part of District's comprehensive plan to enhance water management developed as part of the FRRAWMP. Elements include improved turnout configuration and debris management. This project is expected to improve air quality, conserve energy, and increase water supply and supply reliability.
Removal of Main Canal Bottlenecks	Sutter Extension WD	This project is part of District's comprehensive plan to enhance water management developed as part of the FRRAWMP. This project will reconstruct five structures that currently limit capacity along the Main Canal downstream of the Sunset Pumps in order to increase capacity. The project is expected to increase water supply and supply reliability to meet refuge, irrigation, and other water user demands, with benefits to wildlife and potentially to irrigation efficiency and water quality.
Sunset Project for Integrated Restoration and Efficiency (SPIRE)	Sutter Extension WD	SPIRE is an infrastructure improvement project that enables removal of the Sunset Pumps and the adjacent dam by improving the Sutter-Butte Main Canal (Main Canal). The proposed project will provide multiple regional benefits to a diverse stakeholder group and has broad support at the local, regional, state, and federal level.
Projects and Management Actions to Address Data Gaps		
Investigation of Interactions Between Rivers and Changes in Groundwater Levels	Multi-agencies/GSAs	This action would collect additional data to assist in developing appropriate sustainable management criteria for interconnected surface waters and analyzing changes in stream-aquifer interactions.
Investigation of Source of Elevated Salinity within Shallow Aquifer Zone	Multi-agencies/GSAs	This action would collect additional data needed to evaluate the source of elevated salinity levels within the shallow aquifer zone.
Study of Aquifer Properties	Multi-agencies/GSAs	This action would conduct additional aquifer pumping tests to assess aquifer properties in the Sutter Subbasin.
Additional Assessments of Groundwater Recharge Dynamics and Effects	Multi-agencies/GSAs	This action would conduct additional aquifer studies to assess the dynamics and effects of groundwater recharge in the Subbasin, particularly those effects of GSP projects.
Analysis of Recharge Rates	Multi-agencies/GSAs	This action would conduct additional analyses of recharge rates to assess historical groundwater recharge rates and assess hydraulic connection between different zones in the aquifer system.
Data Collection to Improve the Hydrogeologic Conceptual Model	Multi-agencies/GSAs	This action would collect additional data to understand the hydrogeology of the Sutter Subbasin and bolster the hydrogeologic conceptual model.
AEM Survey of Sutter Buttes	Multi-agencies/GSAs	This action would conduct an airborne electromagnetic (AEM) survey to improve understanding of the unique geology and hydrogeology of the Sutter Buttes.

23 CCR § 354.44		23 CCR §354.44(a)
Project/ Management Action Name	Proponent	Brief Project Description
Development of Uniform Criteria for Defining Stratigraphic Zones	Multi-agencies/GSAs	This action would develop and recommended a uniform set of criteria for defining stratigraphic zones and for logging cuttings from soil boring drilled in the Subbasin.
Comprehensive Sutter Subbasin Groundwater Quality Evaluation	Multi-agencies/GSAs	This action would conduct a comprehensive groundwater quality evaluation for the Sutter Subbasin.
Video Survey RMS Wells with Unknown Construction	Multi-agencies/GSAs	This action would conduct video surveys of RMS wells with unknown construction information in order to collect missing information.
Monitoring Well Refinements	Multi-agencies/GSAs	This action would refine and improve the Subbasin monitoring network by identifying and adding additional, dedicated monitoring wells of known construction, and by collecting and confirming well construction information.
Sutter Buttes Salinity Monitoring	Multi-agencies/GSAs	This action would monitor groundwater salinity (based on EC measurements) at selected locations near the Sutter Buttes on a temporary or permanent basis.
Sutter Buttes Water Quality Inter-Basin Working Group	Multi-agencies/GSAs	GSAs would participate in an inter-basin working group focused on collaborative discussions, consensus-building and planning to address groundwater quality matters associated with the unique geology of the Sutter Buttes area.
Groundwater Dependent Ecosystem Mapping Confirmation	Multi-agencies/GSAs	This action would conduct an on-ground survey to confirm mapping of groundwater dependent ecosystems (GDEs) to support ongoing investigation and monitoring of the relationship between the health of GDEs, groundwater levels, and access to water supplies.
Well Census	Multi-agencies/GSAs	This action would conduct a survey of wells in the Subbasin to identify the location of previously unknown wells, determine their status (e.g., destroyed, active), and/or collect construction information to better inform groundwater use in the Subbasin.
Land Subsidence Monitoring Evaluation	Multi-agencies/GSAs	This action would conduct an assessment of land subsidence data to determine the optimal frequency for ongoing collection and analysis of data relating to inelastic land subsidence.

Table 2. Project Type, Proponent, and Location for all Projects and Management Actions.

23 CCR § 354.44			
Project/ Management Action Name	Project Proponent	Project Type	Project Location
Ongoing and Planned Projects and Management Actions			
System Modernization	Butte WD	Improved Water Management	Butte WD
System Modernization	Sutter Extension WD	Improved Water Management	Sutter Extension WD
Boundary Flow and Primary Spill Measurement and Drainage Recovery	Butte WD	Improved Water Management	Butte WD
Boundary Flow and Primary Spill Measurement and Drainage Recovery	Sutter Extension WD	Improved Water Management	Sutter Extension WD
Dual Source Irrigation Systems	Butte WD	In-lieu Groundwater Recharge	Butte WD
Multi-benefit recharge	Multi-agencies/GSAs	Direct Groundwater Recharge	Various locations throughout Subbasin
Grower Education Relating to On-Farm Practices for Sustainable Groundwater Management	Multi-agencies/GSAs	Improved Water Management	Various locations throughout Subbasin
Installation of additional shallow groundwater monitoring wells	Multi-agencies/GSAs	Monitoring to Fill Data Gap	Various locations throughout Subbasin
Other Projects and Management Actions to be Implemented as Needed			
Removal of Bottlenecks on the Sutter-Butte Main Canal	Butte WD	In-lieu Groundwater Recharge	Butte WD
Improved Delivery Service to Pressurized Irrigation Systems	Butte WD	In-lieu Groundwater Recharge	Butte WD
Wetlands Water Management	Central Valley Joint Venture (CVJV; specific effort by Sutter Extension WD)	Wildlife Habitat Improvement	Central Valley (nine subbasins, including Sutter Subbasin)
Advanced Treatment and Water Recycling	City of Yuba City	Improved Water Management	City of Yuba City

23 CCR § 354.44			
Project/ Management Action Name	Project Proponent	Project Type	Project Location
Aquifer Storage & Recovery and Second Well	City of Yuba City	Direct Groundwater Recharge	City of Yuba City
Backwash Recovery	City of Yuba City	Improved Water Management	City of Yuba City
Electrical SCADA and Telemetry	City of Yuba City	Additional Monitoring	City of Yuba City
Groundwater Well Rehabilitation	City of Yuba City	Water Quality Enhancement	City of Yuba City
New Outfall Diffuser	City of Yuba City	Water Quality Enhancement	City of Yuba City
Replacement of Sewer Mains	City of Yuba City	Water Quality Enhancement	City of Yuba City
Replacement of Water Distribution Mains	City of Yuba City	Reduce Groundwater Demand	City of Yuba City
Feather River Pump Station Fish Screen Feasibility Study	Garden Highway Mutual Water Company	Wildlife Habitat Improvement	Garden Highway Mutual Water Company
Rice field infiltration study to promote FloodMAR projects	Multi-agencies/GSAs	Direct Groundwater Recharge	Various locations throughout Subbasin
Installation of fish screens at Sutter Bypass pumping plants	Multi-agencies/GSAs	Wildlife Habitat Improvement	Sutter Bypass
Improved Service to Pressurized Irrigation Systems	Sutter Extension WD	In-lieu Groundwater Recharge	Sutter Extension WD
Removal of Main Canal Bottlenecks	Sutter Extension WD	In-lieu Groundwater Recharge	Sutter Extension WD
Sunset Project for Integrated Restoration and Efficiency (SPIRE)	Sutter Extension WD	Improved Water Management	Sutter Extension WD
Projects and Management Actions to Address Data Gaps			
Investigation of Interactions Between Rivers and Changes in Groundwater Levels	Multi-agencies/GSAs	Addressing Additional Data Gaps	Various locations throughout Subbasin
Investigation of Source of Elevated Salinity within Shallow Aquifer Zone	Multi-agencies/GSAs	Addressing Additional Data Gaps	Various locations throughout Subbasin
Study of Aquifer Properties	Multi-agencies/GSAs	Addressing Additional Data Gaps	Various locations throughout Subbasin

23 CCR § 354.44			
Project/ Management Action Name	Project Proponent	Project Type	Project Location
Additional Assessments of Groundwater Recharge Dynamics and Effects	Multi-agencies/GSAs	Addressing Additional Data Gaps	Various locations throughout Subbasin
Analysis of Recharge Rates	Multi-agencies/GSAs	Addressing Additional Data Gaps	Various locations throughout Subbasin
Data Collection to Improve the Hydrogeologic Conceptual Model	Multi-agencies/GSAs	Addressing Additional Data Gaps	Various locations throughout Subbasin
AEM Survey of Sutter Buttes	Multi-agencies/GSAs	Addressing Additional Data Gaps	Area surrounding the Sutter Buttes
Development of Uniform Criteria for Defining Stratigraphic Zones	Multi-agencies/GSAs	Addressing Additional Data Gaps	
Comprehensive Sutter Subbasin Groundwater Quality Evaluation	Multi-agencies/GSAs	Addressing Additional Data Gaps	Various locations throughout Subbasin
Video Survey RMS Wells with Unknown Construction	Multi-agencies/GSAs	Addressing Additional Data Gaps	Various locations throughout Subbasin
Monitoring Well Refinements	Multi-agencies/GSAs	Addressing Additional Data Gaps	Various locations throughout Subbasin
Sutter Buttes Salinity Monitoring	Multi-agencies/GSAs	Addressing Additional Data Gaps	Various locations near Sutter Buttes
Sutter Buttes Water Quality Inter-Basin Working Group	Multi-agencies/GSAs	Addressing Additional Data Gaps	
Groundwater Dependent Ecosystem Mapping Confirmation	Multi-agencies/GSAs	Addressing Additional Data Gaps	Various locations throughout Subbasin
Well Census	Multi-agencies/GSAs	Addressing Additional Data Gaps	Various locations throughout Subbasin
Land Subsidence Monitoring Evaluation	Multi-agencies/GSAs	Addressing Additional Data Gaps	Various locations throughout Subbasin

Table 3. Implementation Criteria, Notice Process, Permitting and Regulatory Process, and Timeline for all Projects and Management Actions.

23 CCR § 354.44	23 CCR §354.44(b)(1)(A)	23 CCR §354.44(b)(1)(B)	23 CCR §354.44(b)(3)	23 CCR §354.44(b)(4)		
Project/Management Action Name	Implementation and Termination Timing/Criteria for Implementation	Public and/or Inter-Agency Notice Process	Required Permitting and Regulatory Process or Status of Permitting	Current Status	Anticipated Start Date (Year)	Anticipated Completion Date (Year)
Ongoing and Planned Projects and Management Actions						
System Modernization (Butte WD)	See Note 1 below.	See Note 2 below.	See Note 3 below	Planned, Looking for grant funding	See Note 4 below	See Note 4 below
System Modernization (Sutter Extension WD)	See Note 1 below.	See Note 2 below.	See Note 3 below	Planned, Looking for grant funding	See Note 4 below	See Note 4 below
Boundary Flow and Primary Spill Measurement and Drainage Recovery (Butte WD)	See Note 1 below.	See Note 2 below.	See Note 3 below	Planned, Looking for grant funding	See Note 4 below	See Note 4 below
Boundary Flow and Primary Spill Measurement and Drainage Recovery (Sutter Extension WD)	See Note 1 below.	See Note 2 below.	See Note 3 below	Planned, Looking for grant funding	See Note 4 below	See Note 4 below
Dual Source Irrigation Systems	See Note 1 below.	See Note 2 below.	See Note 3 below	Planned, Looking for grant funding	See Note 4 below	See Note 4 below
Multi-benefit recharge	See Note 1 below.	See Note 2 below.	See Note 3 below	Planned, Looking for grant funding	See Note 4 below	See Note 4 below
Grower Education Relating to On-Farm Practices for Sustainable Groundwater Management	See Note 1 below.	See Note 2 below.	See Note 3 below	Planned, Looking for grant funding	See Note 4 below	See Note 4 below
Installation of additional shallow groundwater monitoring wells	See Note 1 below.	See Note 2 below.	See Note 3 below	Planned, Looking for grant funding	See Note 4 below	See Note 4 below

23 CCR § 354.44	23 CCR §354.44(b)(1)(A)	23 CCR §354.44(b)(1)(B)	23 CCR §354.44(b)(3)	23 CCR §354.44(b)(4)		
Project/Management Action Name	Implementation and Termination Timing/Criteria for Implementation	Public and/or Inter-Agency Notice Process	Required Permitting and Regulatory Process or Status of Permitting	Current Status	Anticipated Start Date (Year)	Anticipated Completion Date (Year)
Other Projects and Management Actions to be Implemented as Needed						
Removal of Bottlenecks on the Sutter-Butte Main Canal	See Note 1 below.	See Note 2 below.	See Note 3 below	Potential	See Note 4 below	See Note 4 below
Improved Delivery Service to Pressurized Irrigation Systems	See Note 1 below.	See Note 2 below.	See Note 3 below	Potential	See Note 4 below	See Note 4 below
Wetlands Water Management	Ongoing	See Note 2 below.	See Note 3 below	Ongoing	See Note 4 below	See Note 4 below
Advanced Treatment and Water Recycling	See Note 1 below.	See Note 2 below.	See Note 3 below	Conducting feasibility study	See Note 4 below	See Note 4 below
Aquifer Storage & Recovery and Second Well	See Note 1 below.	See Note 2 below.	See Note 3 below	Planning phase	See Note 4 below	See Note 4 below
Backwash Recovery	See Note 1 below.	See Note 2 below.	See Note 3 below	Planning phase	See Note 4 below	See Note 4 below
Electrical SCADA and Telemetry	See Note 1 below.	See Note 2 below.	See Note 3 below	Planning phase	See Note 4 below	See Note 4 below
Groundwater Well Rehabilitation	See Note 1 below.	See Note 2 below.	See Note 3 below	Planning phase	See Note 4 below	See Note 4 below
New Outfall Diffuser	See Note 1 below.	See Note 2 below.	See Note 3 below	Conducting feasibility study	See Note 4 below	See Note 4 below
Replacement of Sewer Mains	See Note 1 below.	See Note 2 below.	See Note 3 below	Potential	See Note 4 below	See Note 4 below
Replacement of Water Distribution Mains	See Note 1 below.	See Note 2 below.	See Note 3 below	Potential	See Note 4 below	See Note 4 below
Feather River Pump Station Fish Screen Feasibility Study	See Note 1 below.	See Note 2 below.	See Note 3 below	Potential	See Note 4 below	See Note 4 below
Rice field infiltration study to promote FloodMAR projects	See Note 1 below.	See Note 2 below.	See Note 3 below	Potential	See Note 4 below	See Note 4 below
Installation of fish screens at Sutter Bypass pumping plants	Ongoing	See Note 2 below.	See Note 3 below	Ongoing	See Note 4 below	See Note 4 below
Improved Service to Pressurized Irrigation Systems	See Note 1 below.	See Note 2 below.	See Note 3 below	Potential	See Note 4 below	See Note 4 below

23 CCR § 354.44	23 CCR §354.44(b)(1)(A)	23 CCR §354.44(b)(1)(B)	23 CCR §354.44(b)(3)	23 CCR §354.44(b)(4)		
Project/Management Action Name	Implementation and Termination Timing/Criteria for Implementation	Public and/or Inter-Agency Notice Process	Required Permitting and Regulatory Process or Status of Permitting	Current Status	Anticipated Start Date (Year)	Anticipated Completion Date (Year)
Removal of Main Canal Bottlenecks	See Note 1 below.	See Note 2 below.	See Note 3 below	Potential	See Note 4 below	See Note 4 below
Sunset Project for Integrated Restoration and Efficiency (SPIRE)	See Note 1 below.	See Note 2 below.	See Note 3 below	Planning phase	See Note 4 below	See Note 4 below
Projects and Management Actions to Address Data Gaps						
Investigation of Interactions Between Rivers and Changes in Groundwater Levels	See Note 1 below.	See Note 2 below.	See Note 3 below	Potential	See note 4 below	See note 4 below
Investigation of Source of Elevated Salinity within Shallow Aquifer Zone	See Note 1 below.	See Note 2 below.	See Note 3 below	Potential	See note 4 below	See note 4 below
Study of Aquifer Properties	See Note 1 below.	See Note 2 below.	See Note 3 below	Potential	See note 4 below	See note 4 below
Additional Assessments of Groundwater Recharge Dynamics and Effects	See Note 1 below.	See Note 2 below.	See Note 3 below	Potential	See note 4 below	See note 4 below
Analysis of Recharge Rates	See Note 1 below.	See Note 2 below.	See Note 3 below	Potential	See note 4 below	See note 4 below
Data Collection to Improve the Hydrogeologic Conceptual Model	See Note 1 below.	See Note 2 below.	See Note 3 below	Potential	See note 4 below	See note 4 below
AEM Survey of Sutter Buttes	See Note 1 below.	See Note 2 below.	See Note 3 below	Potential	See note 4 below	See note 4 below
Development of Uniform Criteria for Defining Stratigraphic Zones	See Note 1 below.	See Note 2 below.	See Note 3 below	Potential	See note 4 below	See note 4 below
Comprehensive Sutter Subbasin Groundwater Quality Evaluation	See Note 1 below.	See Note 2 below.	See Note 3 below	Potential	See note 4 below	See note 4 below
Video Survey RMS Wells with Unknown Construction	See Note 1 below.	See Note 2 below.	See Note 3 below	Potential	See note 4 below	See note 4 below

23 CCR § 354.44	23 CCR §354.44(b)(1)(A)	23 CCR §354.44(b)(1)(B)	23 CCR §354.44(b)(3)	23 CCR §354.44(b)(4)		
Project/Management Action Name	Implementation and Termination Timing/Criteria for Implementation	Public and/or Inter-Agency Notice Process	Required Permitting and Regulatory Process or Status of Permitting	Current Status	Anticipated Start Date (Year)	Anticipated Completion Date (Year)
Monitoring Well Refinements	See Note 1 below.	See Note 2 below.	See Note 3 below	Potential	See note 4 below	See note 4 below
Sutter Buttes Salinity Monitoring	See Note 1 below.	See Note 2 below.	See Note 3 below	Potential	See note 4 below	See note 4 below
Sutter Buttes Water Quality Inter-Basin Working Group	See Note 1 below.	See Note 2 below.	See Note 3 below	Potential	See note 4 below	See note 4 below
Groundwater Dependent Ecosystem Mapping Confirmation	See Note 1 below.	See Note 2 below.	See Note 3 below	Potential	See note 4 below	See note 4 below
Well Census	See Note 1 below.	See Note 2 below.	See Note 3 below	Potential	See note 4 below	See note 4 below
Land Subsidence Monitoring Evaluation	See Note 1 below.	See Note 2 below.	See Note 3 below	Potential	See note 4 below	See note 4 below

Notes:

1. This PMA is currently in the early conceptual stage. Thus the implementation and termination dates have yet to be determined. Criteria for implementation may, among other factors, be linked to the measurable objectives and will be provided in GSP annual reports and five-year updates when known.
2. Public and/or Inter-Agency Noticing will be facilitated through GSA board meetings, GSA and/or cooperating agency website(s), GSA and/or cooperating agency newsletters, inter-basin coordination meetings, agency governing body public meetings, GSP annual reports and five-year updates, public scoping meetings and environmental/regulatory permitting notification.
3. Required permitting and regulatory review will be project-specific and initiated through consultation with applicable governing agencies. Governing agencies for which consultation will be initiated may include, but are not limited to: DWR, SWRCB, CDFW, Flood Board, Regional Water Boards, USFWS, NMFS, LAFCO, applicable County(ies), and CARB.
4. This PMA is currently in the early conceptual stage. Thus, the start and completion dates for this activity have yet to be determined and will be provided in GSP annual reports and five-year updates when known.

Table 4. Anticipated Benefits of all Projects and Management Actions.

23 CCR § 354.44	23 CCR §354.44(b)(5)			
Project/Management Action Name	Sustainability Indicators Expected to Benefit	Specific Multi-Benefits Expected	Serves Disadvantaged Community (If so, which one?)	Expected Yield
Ongoing and Planned Projects and Management Actions				
System Modernization (Butte WD)	Groundwater levels, groundwater storage, and depletions of interconnected surface water		See Note 3 below	2,000-5,000 AF/yr (modified flow quantity)
System Modernization (Sutter Extension WD)	Groundwater levels, groundwater storage, and depletions of interconnected surface water		See Note 3 below	5,200-12,750 AF/yr (modified flow quantity)
Boundary Flow and Primary Spill Measurement and Drainage Recovery (Butte WD)	Groundwater levels, groundwater storage, and depletions of interconnected surface water	Improved control and timing of in-stream flow releases, benefitting protected fish species and other downstream wildlife	See Note 3 below	3,500-10,500 AF/yr (modified flow quantity)
Boundary Flow and Primary Spill Measurement and Drainage Recovery (Sutter Extension WD)	Groundwater levels, groundwater storage, and depletions of interconnected surface water	Improved control and timing of in-stream flow releases, benefitting protected fish species and other downstream wildlife	See Note 3 below	4,000-11,000 AF/yr (modified flow quantity)
Dual Source Irrigation Systems	Groundwater levels, groundwater storage, depletions of interconnected surface water, and land subsidence		See Note 3 below	See Note 4 below
Multi-benefit recharge	Groundwater levels, groundwater storage, and depletions of interconnected surface water	Habitat for shorebirds migrating along the Pacific Flyway	See Note 3 below	See Note 4 below
Grower Education Relating to On-Farm Practices for Sustainable Groundwater Management	Groundwater levels, groundwater storage, and depletions of interconnected surface water		See Note 3 below	See Note 4 below

23 CCR § 354.44	23 CCR §354.44(b)(5)			
Project/Management Action Name	Sustainability Indicators Expected to Benefit	Specific Multi-Benefits Expected	Serves Disadvantaged Community (If so, which one?)	Expected Yield
Installation of additional shallow groundwater monitoring wells	See Note 1 below		See Note 3 below	See Note 4 below
Other Projects and Management Actions to be Implemented as Needed				
Removal of Bottlenecks on the Sutter-Butte Main Canal	Groundwater levels, groundwater storage, depletions of interconnected surface water, and land subsidence		See Note 3 below	See Note 4 below
Improved Delivery Service to Pressurized Irrigation Systems	Groundwater levels, groundwater storage, depletions of interconnected surface water, and land subsidence		See Note 3 below	See Note 4 below
Wetlands Water Management	See Note 2 below	Habitat for waterfowl, shorebird, waterbird, and riparian songbird populations	See Note 3 below	Benefits to wetland restoration, wetland protection, and waterfowl habitat enhancement are reported for the Butte and Sutter Subbasins in aggregate, as described by the CVJV. However, the expected yield to the Sutter Subbasin groundwater system has not been quantified.
Advanced Treatment and Water Recycling	Groundwater levels, groundwater storage, and depletions of interconnected surface water		See Note 3 below	See Note 4 below
Aquifer Storage & Recovery and Second Well	Groundwater levels, groundwater storage, and depletions of interconnected surface water		See Note 3 below	See Note 4 below

23 CCR § 354.44	23 CCR §354.44(b)(5)			
Project/Management Action Name	Sustainability Indicators Expected to Benefit	Specific Multi-Benefits Expected	Serves Disadvantaged Community (If so, which one?)	Expected Yield
Backwash Recovery	Groundwater levels, groundwater storage, and depletions of interconnected surface water		See Note 3 below	See Note 4 below
Electrical SCADA and Telemetry	See Note 1 below		See Note 3 below	See Note 4 below
Groundwater Well Rehabilitation	Water quality		See Note 3 below	See Note 4 below
New Outfall Diffuser	Water quality		See Note 3 below	See Note 4 below
Replacement of Sewer Mains	Water quality		See Note 3 below	See Note 4 below
Replacement of Water Distribution Mains	Groundwater levels, groundwater storage, and depletions of interconnected surface water		See Note 3 below	See Note 4 below
Feather River Pump Station Fish Screen Feasibility Study	See Note 2 below		See Note 3 below	See Note 4 below
Rice field infiltration study to promote FloodMAR projects	See Note 1 below		See Note 3 below	See Note 4 below
Installation of fish screens at Sutter Bypass pumping plants	See Note 2 below	Increase in population of spring-run and fall-run protected fish species	See Note 3 below	Benefits are expected for environmental water users and for maintaining access to surface water supplies. However, the expected yield to the Sutter Subbasin groundwater system has not been quantified.

23 CCR § 354.44	23 CCR §354.44(b)(5)			
Project/Management Action Name	Sustainability Indicators Expected to Benefit	Specific Multi-Benefits Expected	Serves Disadvantaged Community (If so, which one?)	Expected Yield
Improved Service to Pressurized Irrigation Systems	Groundwater levels, groundwater storage, depletions of interconnected surface water, and land subsidence		See Note 3 below	See Note 4 below
Removal of Main Canal Bottlenecks	Groundwater levels, groundwater storage, depletions of interconnected surface water, and land subsidence		See Note 3 below	See Note 4 below
Sunset Project for Integrated Restoration and Efficiency (SPIRE)	Groundwater levels, groundwater storage, and depletions of interconnected surface water		See Note 3 below	See Note 4 below
Projects and Management Actions to Address Data Gaps				
Investigation of Interactions Between Rivers and Changes in Groundwater Levels	See Note 1 below		See Note 3 below	See Note 4 below
Investigation of Source of Elevated Salinity within Shallow Aquifer Zone	See Note 1 below		See Note 3 below	See Note 4 below
Study of Aquifer Properties	See Note 1 below		See Note 3 below	See Note 4 below
Additional Assessments of Groundwater Recharge Dynamics and Effects	See Note 1 below		See Note 3 below	See Note 4 below
Analysis of Recharge Rates	See Note 1 below		See Note 3 below	See Note 4 below
Data Collection to Improve the Hydrogeologic Conceptual Model	See Note 1 below		See Note 3 below	See Note 4 below
AEM Survey of Sutter Buttes	See Note 1 below		See Note 3 below	See Note 4 below
Development of Uniform Criteria for Defining Stratigraphic Zones	See Note 1 below		See Note 3 below	See Note 4 below

23 CCR § 354.44	23 CCR §354.44(b)(5)			
Project/Management Action Name	Sustainability Indicators Expected to Benefit	Specific Multi-Benefits Expected	Serves Disadvantaged Community (If so, which one?)	Expected Yield
Comprehensive Sutter Subbasin Groundwater Quality Evaluation	See Note 1 below		See Note 3 below	See Note 4 below
Video Survey RMS Wells with Unknown Construction	See Note 1 below		See Note 3 below	See Note 4 below
Monitoring Well Refinements	See Note 1 below		See Note 3 below	See Note 4 below
Sutter Buttes Salinity Monitoring	See Note 1 below		See Note 3 below	See Note 4 below
Sutter Buttes Water Quality Inter-Basin Working Group	See Note 1 below		See Note 3 below	See Note 4 below
Groundwater Dependent Ecosystem Mapping Confirmation	See Note 1 below		See Note 3 below	See Note 4 below
Well Census	See Note 1 below		See Note 3 below	See Note 4 below
Land Subsidence Monitoring Evaluation	See Note 1 below		See Note 3 below	See Note 4 below

Notes

1. Coordination, data sharing, and additional monitoring are beneficial to GSP implementation and tracking progress toward the Subbasin sustainability goal. However, there are no anticipated direct benefits to specific sustainability indicators.
2. PMAs that improve wildlife habitat support environmental beneficial uses of water and ecosystem health while allowing Districts to maintain surface water use in agriculture. While useful for ongoing sustainability, there are no anticipated direct benefits to specific sustainability indicators.
3. The majority of areas, especially population centers, within the Sutter Subbasin are classified as either Severely Disadvantaged Communities, Disadvantaged Communities, or Economically Distressed Areas (based on 2018 census block groups, tracts, and places).
4. This PMA is currently in the early conceptual stage. Thus the expected yield of this PMA has yet to be determined and will be reported in GSP annual reports and five-year updates when known. Benefits are generally expected to accrue in all years beginning the first year of implementation for most PMAs.

Table 5. Benefit Evaluation and Water Source for all Projects and Management Actions.

23 CCR § 354.44	23 CCR §354.44(b)(5)	23 CCR §354.44(b)(6)	
Project/Management Action Name	Benefit Evaluation Methodology	Water Source	Water Source Reliability
Ongoing and Planned Projects and Management Actions			
System Modernization (Butte WD)	See Note 1 below	Feather River through diversion agreements	Generally reliable. See GSP Chapter 7 for a discussion of historical supplies available to the Joint Districts.
System Modernization (Sutter Extension WD)	See Note 1 below	Feather River through diversion agreements	Generally reliable. See GSP Chapter 7 for a discussion of historical supplies available to the Joint Districts.
Boundary Flow and Primary Spill Measurement and Drainage Recovery (Butte WD)	See Note 1 below	Feather River through diversion agreements	Generally reliable. See GSP Chapter 7 for a discussion of historical supplies available to the Joint Districts.
Boundary Flow and Primary Spill Measurement and Drainage Recovery (Sutter Extension WD)	See Note 1 below	Feather River through diversion agreements	Generally reliable. See GSP Chapter 7 for a discussion of historical supplies available to the Joint Districts.
Dual Source Irrigation Systems	See Note 1 below	Feather River through diversion agreements	Generally reliable. See GSP Chapter 7 for a discussion of historical supplies available to the Joint Districts.
Multi-benefit recharge	See Note 1 below	Existing water supply contracts or water rights	Generally reliable
Grower Education Relating to On-Farm Practices for Sustainable Groundwater Management	See Note 1 below	See Note 2 below	See Note 2 below
Installation of additional shallow groundwater monitoring wells	See Note 1 below	See Note 2 below	See Note 2 below
Other Projects and Management Actions to be Implemented as Needed			
Removal of Bottlenecks on the Sutter-Butte Main Canal	See Note 1 below	Feather River through diversion agreements	Generally reliable. See GSP Chapter 7 for a discussion of historical supplies available to the Joint Districts.

23 CCR § 354.44	23 CCR §354.44(b)(5)	23 CCR §354.44(b)(6)	
Project/Management Action Name	Benefit Evaluation Methodology	Water Source	Water Source Reliability
Improved Delivery Service to Pressurized Irrigation Systems	See Note 1 below	Feather River through diversion agreements	Generally reliable. See GSP Chapter 7 for a discussion of historical supplies available to the Joint Districts.
Wetlands Water Management	Benefits to the Sutter Subbasin groundwater system may be evaluated as recommended for other PMAs. See Note 1 below	Sacramento River through existing CVP contracts; Feather River through diversion agreements	Generally reliable. See GSP Chapter 7 for a discussion of historical supplies available to the Joint Districts.
Advanced Treatment and Water Recycling	See Note 1 below	Existing city water supplies, to be recycled for multiple purposes	Generally reliable
Aquifer Storage & Recovery and Second Well	See Note 1 below	Existing city water supplies, to be stored (or banked) for use during dry periods	Generally reliable
Backwash Recovery	See Note 1 below	Existing city water supplies	Generally reliable
Electrical SCADA and Telemetry	See Note 1 below	See Note 2 below	See Note 2 below
Groundwater Well Rehabilitation	See Note 1 below	See Note 2 below	See Note 2 below
New Outfall Diffuser	See Note 1 below	See Note 2 below	See Note 2 below
Replacement of Sewer Mains	See Note 1 below	See Note 2 below	See Note 2 below
Replacement of Water Distribution Mains	See Note 1 below	See Note 2 below	See Note 2 below
Feather River Pump Station Fish Screen Feasibility Study	See Note 1 below	See Note 2 below	See Note 2 below
Rice field infiltration study to promote FloodMAR projects	See Note 1 below	See Note 2 below	See Note 2 below
Installation of fish screens at Sutter Bypass pumping plants	Benefits to the Sutter Subbasin groundwater system may be evaluated as recommended for other PMAs. See Note 1 below	See Note 2 below	See Note 2 below
Improved Service to Pressurized Irrigation Systems	See Note 1 below	Feather River through diversion agreements	Generally reliable. See GSP Chapter 7 for a discussion of historical supplies available to the Joint Districts.

23 CCR § 354.44	23 CCR §354.44(b)(5)	23 CCR §354.44(b)(6)	
Project/Management Action Name	Benefit Evaluation Methodology	Water Source	Water Source Reliability
Removal of Main Canal Bottlenecks	See Note 1 below	Feather River through diversion agreements	Generally reliable. See GSP Chapter 7 for a discussion of historical supplies available to the Joint Districts.
Sunset Project for Integrated Restoration and Efficiency (SPIRE)	See Note 1 below	See Note 2 below	See Note 2 below
Projects and Management Actions to Address Data Gaps			
Investigation of Interactions Between Rivers and Changes in Groundwater Levels	See Note 1 below	See Note 2 below	See Note 2 below
Investigation of Source of Elevated Salinity within Shallow Aquifer Zone	See Note 1 below	See Note 2 below	See Note 2 below
Study of Aquifer Properties	See Note 1 below	See Note 2 below	See Note 2 below
Additional Assessments of Groundwater Recharge Dynamics and Effects	See Note 1 below	See Note 2 below	See Note 2 below
Analysis of Recharge Rates	See Note 1 below	See Note 2 below	See Note 2 below
Data Collection to Improve the Hydrogeologic Conceptual Model	See Note 1 below	See Note 2 below	See Note 2 below
AEM Survey of Sutter Buttes	See Note 1 below	See Note 2 below	See Note 2 below
Development of Uniform Criteria for Defining Stratigraphic Zones	See Note 1 below	See Note 2 below	See Note 2 below
Comprehensive Sutter Subbasin Groundwater Quality Evaluation	See Note 1 below	See Note 2 below	See Note 2 below
Video Survey RMS Wells with Unknown Construction	See Note 1 below	See Note 2 below	See Note 2 below
Monitoring Well Refinements	See Note 1 below	See Note 2 below	See Note 2 below
Sutter Buttes Salinity Monitoring	See Note 1 below	See Note 2 below	See Note 2 below

23 CCR § 354.44	23 CCR §354.44(b)(5)	23 CCR §354.44(b)(6)	
Project/Management Action Name	Benefit Evaluation Methodology	Water Source	Water Source Reliability
Sutter Buttes Water Quality Inter-Basin Working Group	See Note 1 below	See Note 2 below	See Note 2 below
Groundwater Dependent Ecosystem Mapping Confirmation	See Note 1 below	See Note 2 below	See Note 2 below
Well Census	See Note 1 below	See Note 2 below	See Note 2 below
Land Subsidence Monitoring Evaluation	See Note 1 below	See Note 2 below	See Note 2 below

Notes:

1. Evaluation of benefits may be quantified through with-project monitoring. With-project monitoring would be compared to without-project data as a means of quantifying the benefit. With-project monitoring may include, but is not limited to; flow measurement consistent with state regulations, consumptive use analysis, reductions in GW use, well monitoring, determination of infiltration rates, water balance analysis, as-built drawings and stream gaging.
2. This PMA does not rely on a particular water source, but may be useful for managing water resources.

Table 6. Legal Authority Requirements, Estimated Cost, and Potential Funding Sources for all Projects and Management Actions.

23 CCR § 354.44	23 CCR §354.44(b)(7)	23 CCR §354.44(b)(8)	
Project/Management Action Name	Legal Authority Required	Estimated Cost	Potential Funding Sources
Ongoing and Planned Projects and Management Actions			
System Modernization (Butte WD)	See Note 1 below	\$1,035,000 annualized capital recovery and O&M (2014 estimates adjusted to 2021)	See Note 3 below
System Modernization (Sutter Extension WD)	See Note 1 below	\$1,138,000 annualized capital recovery and O&M (2014 estimates adjusted to 2021)	See Note 3 below
Boundary Flow and Primary Spill Measurement and Drainage Recovery (Butte WD)	See Note 1 below	\$1,184,000 capital cost; \$117,000 annualized capital recovery and O&M (2014 estimates adjusted to 2021)	See Note 3 below
Boundary Flow and Primary Spill Measurement and Drainage Recovery (Sutter Extension WD)	See Note 1 below	\$1,154,000 capital cost; \$106,000 annualized capital recovery and O&M (2014 estimates adjusted to 2021)	See Note 3 below
Dual Source Irrigation Systems	See Note 1 below	See Note 2 below	See Note 3 below
Multi-benefit recharge	See Note 1 below	See Note 2 below	See Note 3 below
Grower Education Relating to On-Farm Practices for Sustainable Groundwater Management	See Note 1 below	See Note 2 below	See Note 3 below
Installation of additional shallow groundwater monitoring wells	See Note 1 below	See Note 2 below	See Note 3 below
Other Projects and Management Actions to be Implemented as Needed			
Removal of Bottlenecks on the Sutter-Butte Main Canal	See Note 1 below	\$1,009,000 initial cost; \$55,000 annualized capital recovery and O&M (2014 estimates adjusted to 2021)	See Note 3 below
Improved Delivery Service to Pressurized Irrigation Systems	See Note 1 below	Pipeline conversion: \$2,804,800 initial cost; \$386,800 annualized capital recovery and O&M (2014 estimates adjusted to 2021); other costs not estimated in FRRAWMP	See Note 3 below
Wetlands Water Management	See Note 1 below	The costs of this project are not reported for the Sutter Subbasin.	See Note 3 below

23 CCR § 354.44	23 CCR §354.44(b)(7)	23 CCR §354.44(b)(8)	
Project/Management Action Name	Legal Authority Required	Estimated Cost	Potential Funding Sources
Advanced Treatment and Water Recycling	See Note 1 below	See Note 2 below	See Note 3 below
Aquifer Storage & Recovery and Second Well	See Note 1 below	See Note 2 below	See Note 3 below
Backwash Recovery	See Note 1 below	See Note 2 below	See Note 3 below
Electrical SCADA and Telemetry	See Note 1 below	See Note 2 below	See Note 3 below
Groundwater Well Rehabilitation	See Note 1 below	See Note 2 below	See Note 3 below
New Outfall Diffuser	See Note 1 below	See Note 2 below	See Note 3 below
Replacement of Sewer Mains	See Note 1 below	See Note 2 below	See Note 3 below
Replacement of Water Distribution Mains	See Note 1 below	See Note 2 below	See Note 3 below
Feather River Pump Station Fish Screen Feasibility Study	See Note 1 below	See Note 2 below	See Note 3 below
Rice field infiltration study to promote FloodMAR projects	See Note 1 below	See Note 2 below	See Note 3 below
Installation of fish screens at Sutter Bypass pumping plants	See Note 1 below	The costs of this project are not reported for the Sutter Subbasin.	See Note 3 below
Improved Service to Pressurized Irrigation Systems	See Note 1 below	Reconnaissance-level unit costs in FRRAWMP 2016 Update, Vol. 2 Section 6	See Note 3 below
Removal of Main Canal Bottlenecks	See Note 1 below	\$5,344,300 capital cost; \$293,000 annual cost	See Note 3 below
Sunset Project for Integrated Restoration and Efficiency (SPIRE)	See Note 1 below	See Note 2 below	See Note 3 below
Projects and Management Actions to Address Data Gaps			
Investigation of Interactions Between Rivers and Changes in Groundwater Levels	See Note 1 below	See Note 2 below	See Note 3 below

23 CCR § 354.44	23 CCR §354.44(b)(7)	23 CCR §354.44(b)(8)	
Project/Management Action Name	Legal Authority Required	Estimated Cost	Potential Funding Sources
Investigation of Source of Elevated Salinity within Shallow Aquifer Zone	See Note 1 below	See Note 2 below	See Note 3 below
Study of Aquifer Properties	See Note 1 below	See Note 2 below	See Note 3 below
Additional Assessments of Groundwater Recharge Dynamics and Effects	See Note 1 below	See Note 2 below	See Note 3 below
Analysis of Recharge Rates	See Note 1 below	See Note 2 below	See Note 3 below
Data Collection to Improve the Hydrogeologic Conceptual Model	See Note 1 below	See Note 2 below	See Note 3 below
AEM Survey of Sutter Buttes	See Note 1 below	See Note 2 below	See Note 3 below
Development of Uniform Criteria for Defining Stratigraphic Zones	See Note 1 below	See Note 2 below	See Note 3 below
Comprehensive Sutter Subbasin Groundwater Quality Evaluation	See Note 1 below	See Note 2 below	See Note 3 below
Video Survey RMS Wells with Unknown Construction	See Note 1 below	See Note 2 below	See Note 3 below
Monitoring Well Refinements	See Note 1 below	See Note 2 below	See Note 3 below
Sutter Buttes Salinity Monitoring	See Note 1 below	See Note 2 below	See Note 3 below
Sutter Buttes Water Quality Inter-Basin Working Group	See Note 1 below	See Note 2 below	See Note 3 below
Groundwater Dependent Ecosystem Mapping Confirmation	See Note 1 below	See Note 2 below	See Note 3 below
Well Census	See Note 1 below	See Note 2 below	See Note 3 below
Land Subsidence Monitoring Evaluation	See Note 1 below	See Note 2 below	See Note 3 below

Notes:

1. GSAs, Districts and individual proponents have the authority to plan and implement projects, including surveys, studies, and other monitoring efforts.
2. This PMA is currently in the early conceptual stage. Thus the anticipated costs of this PMA have yet to be determined and will be reported in GSP annual reports and five-year updates when known.
3. Potential funding sources are being evaluated as PMA planning continues; they include, but are not limited to, the following: grants, loans, bonds, assessment fees, and cost-sharing programs. Potential funding sources will be reported in GSP annual reports and five-year updates when known

Appendix 7-B
Feather River Regional Agricultural Water Management
Plan, 2014: Butte Water District Potential Projects to
Enhance Water Management Capabilities

This page intentionally left blank.

Feather River Regional Agricultural Water Management Plan

Volume II: Supplier Plan Components

August 2014



Prepared by

Northern California Water Association and
the Feather River Water Suppliers



4. Butte Water District

This section of the Feather River Regional AWMP contains plan components specific to Butte Water District (BWD).

4.1 Table of Contents

Contents

4.	Butte Water District.....	4-1
4.1	Table of Contents.....	4-1
4.2	Introduction.....	4-3
4.3	Cross-Reference to Requirements of SBx7-7.....	4-5
4.4	Plan Preparation and Adoption.....	4-9
4.4.1	Regulatory Compliance	4-9
4.4.2	Public Participation and Adoption	4-9
4.4.3	Regional Coordination.....	4-9
4.5	Background and Description of Service Area.....	4-10
4.5.1	History and Organization	4-10
4.5.2	Size and Location of Service Area	4-12
4.5.3	Distribution and Drainage System	4-12
4.5.4	Terrain and Soils.....	4-19
4.5.5	Climate	4-23
4.5.6	Operating Rules and Regulations.....	4-24
4.5.7	Water Delivery Measurement and Calculation	4-24
4.5.8	Water Rate Schedules and Billing.....	4-25
4.5.9	Water Shortage Allocation Policies and Contingency Plan	4-26
4.5.10	Policies Addressing Wasteful Use of Water.....	4-26
4.6	Inventory of Water Supplies.....	4-27
4.6.1	Introduction.....	4-27
4.6.2	Surface Water Supply.....	4-27
4.6.3	Groundwater Supply	4-27
4.6.4	Other Water Supplies.....	4-29
4.6.5	Water Quality Monitoring Practices	4-29
4.7	Water Balance.....	4-30
4.7.1	Overview	4-30
4.7.2	Analytical Approach	4-30
4.7.3	Water Use.....	4-37
4.7.4	Drainage	4-46
4.7.5	Water Accounting (Summary of Water Balance Results).....	4-48
4.8	Climate Change.....	4-57
4.9	Efficient Water Management Practices and Water Use Efficiency.....	4-58
4.9.1	Efficient Water Management Practices	4-58

4.9.2	Evaluation of Water Use Efficiency Improvements.....	4-65
4.10	Attachments	4-75
4.10.1	Public Coordination and Adoption.....	4-77
4.10.2	Rules and Regulations	4-79
4.10.3	Potential Projects to Enhance Water Management Capabilities.....	4-87

Tables

Table 4.1.	Cross-Reference of Relevant Sections of the California Water Code to BWD 2014 AWMP.5	
Table 4.2.	Characteristics of Dominant Soils in Butte Water District.	4-20
Table 4.3.	Mean Daily Weather Parameters by Month at Durham CIMIS Station (October 1984 to September 2012).....	4-24
Table 4.4.	Water Balance Flow Paths, Supporting Data, and Estimated Uncertainty.	4-35
Table 4.5.	Crop and Idle Acres, 1999-2012.....	4-37
Table 6.6.	Average Acreages and Annual Evapotranspiration Rates by Crop.....	4-41
Table 4.7.	Estimated Winter Diversions and Applied Water for Managed Wetlands and Rice Straw Decomposition.....	4-42
Table 4.8.	Total Groundwater Recharge, 1999-2012.	4-43
Table 4.9.	Net Groundwater Recharge, 1999-2012.....	4-45
Table 4.10.	Crop Idling Water Transfer Volumes, 1999-2012.....	4-45
Table 4.11.	Estimated Surface Outflow Volumes, 1999-2012.	4-46
Table 6.12.	Estimated Tailwater Volumes, 1999-2012.	4-47
Table 4.13.	Distribution and Drainage System Annual Water Balance Results, 1999-2012.....	4-53
Table 4.14.	Farmed Lands Annual Water Balance Results, 1999-2012.....	4-53
Table 4.15.	EWMP Implementation Status.	4-61
Table 4.16.	Summary of WUE Improvements by EWMP.	4-67
Table 4.17.	WUE Improvement Categories.....	4-71
Table 4.18.	Applicability of EWMPs to WUE Improvement Categories.	4-73
Table 4.19.	Evaluation of Relative Magnitude of Past and Future WUE Improvements by EWMP. ...	4-74

Figures

Figure 4.1.	Organizational Chart.	4-12
Figure 4.2.	Boundary Flows and Irrigation and Drainage Facilities.....	4-17
Figure 4.3.	Water Balance Structure.....	4-32
Figure 4.4.	Crop and Idle Acres, 1999-2012.....	4-38
Figure 4.5.	March to September 2009 SEBAL Actual ET.....	4-39
Figure 4.6.	Average Monthly Consumptive Use of Water.	4-40
Figure 4.7.	Conceptualization of Shallow Groundwater Interception in Rice Growing Areas.....	4-44
Figure 4.8.	District Water Balance 1999-2012.....	4-49
Figure 4.9.	Average Monthly Inflows, 1999-2012.	4-50
Figure 4.10.	Average Monthly Outflows, 1999-2012.....	4-51



4.10.3 Potential Projects to Enhance Water Management Capabilities

A description of potential projects to enhance BWD water management capabilities is provided on the following pages.



[This Page Intentionally Blank]

Attachment 4.10.3: Potential Projects to Enhance BWD Water Management Capabilities

Overview

A total of four potential projects to enhance water management by Butte Water District (BWD) were evaluated. These range from comprehensive system modernization to localized projects related to boundary outflow and safety spill measurement, removal of bottlenecks, and improving delivery service to customers using pressurized irrigation. For each project, reconnaissance level implementation costs have been estimated. It is anticipated that these projects would be implemented over time, subject to the availability of funding and project prioritization. Potential improvements are assembled into the following project categories:

1. System Modernization
2. Boundary Outflow and Primary Spill Measurement
3. Removal of Bottlenecks on the Sutter-Butte Main Canal
4. Alternatives for Improving Delivery Service to Pressurized Irrigation Systems

Summary of Cost Estimation

Reconnaissance level cost estimates were prepared for each improvement project as a basis for prioritization and funding of site improvements. The following summary of the cost estimation procedure applies to all projects described in this attachment.

Site inventories were completed with the help of district staff, and several sites were visited to provide information to develop conceptual designs to estimate material and labor quantities. Not all sites were surveyed in detail, and dimensions of structures and cross-sections were gathered only at a sample of locations. Many of the sites of a specific type (e.g. water level control) were similar in design and varied primarily in capacity. For this reason, conceptual designs were developed for each site type in several configurations and in a range of capacities as appropriate. The typical conceptual designs are listed in Table 1. Costs for the typical designs were developed based on estimates of required site components, quantities, and unit costs.

Table 1. Typical conceptual designs and the variations/configurations developed for purposes of cost estimation.

	Typical Design	Variations/Configurations
A	Acoustic Doppler velocimeter in lined section of channel	
B	Acoustic Doppler velocimeter in unlined section of channel	I. High capacity canal II. Mid-range capacity canal
C	New Precast Spill Box with 36" propeller meter at d/s end	I. 4 ft weir box II. 6 ft weir box
D	Precast headwall with new 36" undershot gate, piping and propeller meter at d/s end	
E	New Precast Spill Box with fixed, sharp-crest weir plate	I. 4 ft weir box II. 6 ft weir box
F	Locally automated combination weir	450, 250, 150, 75, 50, and 25 cfs capacity
G	Manually Adjusted Undershot Gates	Cost estimated on a per square foot of gate area basis
H	Automated Flow Control Gates	Cost estimated on a per square foot of gate area basis
I	SCADA hardware and related communication components	I. No add'l power source II. No add'l power source, w/ PLC III. W/ solar power system and PLC IV. W/ solar power system, pressure transducer and related components

Unit Costs

Unit costs for the various work items and materials were compiled from sources including published values, local suppliers, contractors and installers, and references from works previously completed by Davids Engineering and others. Standard unit prices were increased by 10% assuming prevailing labor rates will apply. Costs include material and equipment, installation labor, shipping, and tax (where applicable).

Cost types fall into three categories: Direct Costs, Indirect Costs, and Contingencies. Direct costs are associated with physical site improvements, while indirect costs represent other project costs such as engineering and design, environmental permitting, construction management, administration and legal, and overhead and are included as a percentage of the sum of extended costs plus the contingency. Contingency is applied to the subtotal of direct costs based on uncertainties present at this level of design and cost estimation and to account for unforeseen requirements.

Total indirect costs plus contingency vary by site type to account for differences in site complexities, construction effort, engineering and design requirements, the source of the unit cost information, and professional judgment. Mark-ups are summarized in Table 2.

All projects were assumed to be designed and constructed using competitive bidding processes. It is possible the site improvements could be implemented under a design-build scenario or by district forces at lesser costs than estimated in this analysis.

Table 2. Summary of range of percentage multipliers applied to cost estimate to account for indirect costs and contingencies.

Range of Percentages Applied to Total Direct Costs		
Engineering & Construction Management	10%	to 20%
Legal, Environmental and Administration	0%	to 20%
Total =	10%	to 40%
Percentage Applied to Total Site Cost		
Contingency	10%	to 20%

Quantities

Canal capacities were determined through consultation with district operators or estimated using Manning’s equation for open channel flow using a combination of measured and assumed cross sectional geometry. For each canal, the top water width was measured at several locations using the point-to-point utility in Google Earth. Canal water depths were estimated based on spot field observations and by designating each canal a Main, Lateral, or sublateral canal. Average slopes along the canal lengths were estimated from Google Earth and USGS topographic maps. A Manning’s roughness coefficient of 0.033 was used assuming excavated earthen canals, winding and sluggish with grass and some weeds, as defined in Te Chow (1959)¹. Where available, calculated capacities were validated with measured capacities or typical peak diversions and globally adjusted as appropriate.

Quantities for larger heading and water level control structures were independently calculated and compared with conceptual structures designed for the Sutter Butte Regional Conveyance Study², conceptual structures in the WCWD Draft 20-Year Capital Improvements Plan, and with 60% design cost estimates³ for the BWGWD Gray Lodge Wildlife Area Supply Project.

Site Specific Improvement costs

For each site, applicable designs and base costs for typical sites were used without modification, adjusted to reflect actual site conditions, or combined with components for other sites to create site specific improvement capital costs and annualized costs, as appropriate.

Annual Costs

Annual capital repayment was estimated for each item using an amortization rate of 5 percent and capital recovery factors calculated using the estimated expected life of each cost item. Total annual costs also include annual operations and maintenance (O&M) costs associated with the improvement. O&M costs were estimates as a percentage of the total extended cost of the item. The percentage ranged from 0 percent for items not requiring annual maintenance to 5 percent for electrical or mechanical components where more frequent O&M is necessary to ensure reliable operation and system longevity.

¹ Te Chow, Ven. 1959. Open Channel Hydraulics. The Blackburn Press, Caldwell, New Jersey, U.S.A.

² GEI Consultants, 2006. Regional Conveyance System Improvement Project – Final Report, May 2006. Completed for Sutter Extension Water District by Bookman-Edmonston, a division of GEI Consultants, Inc.

³ Engineer’s Opinion of Probable Construction Cost, 60% Design. October 2011. Prepared by Provost and Pritchard Consulting Engineers.

Project 1: System Modernization Project

Project Description

The system modernization project aligns with BWD’s desire to develop and implement management strategies and tools to meet water management objectives, including water conservation at the district scale and improved delivery service to customers, especially those utilizing pressurized irrigation systems and weighing the option of utilizing surface water or groundwater.

System modernization is generally implemented to achieve one or more of the following goals:

1. Increase the efficiency of the distribution system to conserve water at the district scale,
2. Increase the level of service provided to growers and respond to changes in cropping or irrigation method,
3. Reduce potential risks to the safety of operations staff, and
4. Improve overall operability and management.

A phased, comprehensive modernization plan provides a road map for implementation that allows for improvements to occur over time at a pace that considers available funds and implements high priority improvements first to meet objectives in the most cost effective manner possible. The system modernization strategy developed for Butte Water District is a top-down strategy involving four phases with flow measurement as an overarching improvement. It is anticipated that the actual phasing of improvements to individual sites may differ from those described herein as informed by evaluation of opportunities, costs, and other considerations over time.

System modernization generally includes improvements to three site types: heading structures, upstream water level control structures, and spill structures. The objectives for each of these site types is described in Table 3. The specific improvements that would be completed under each of the four phases of modernization is described in additional detail below.

Table 3. System Modernization Objectives by Site Category.

Site Category	General Modernization Objective
Heading	<ul style="list-style-type: none"> • Replace old, aging and/or deteriorated structures and equipment, as needed. • Provide increased accuracy, repeatability, and consistency in downstream deliveries to district customers prevent farm runoff and tail end spills. • Improve ability for flow adjustments to prevent spill and enhance delivery service. • Increase safety of site for operators.
Upstream Water Level Control	<ul style="list-style-type: none"> • Replace old, aging and/or deteriorated structures and equipment, as needed. • Maintain constant upstream deliveries by reducing fluctuation in desired upstream water level over a range of canal flow rates. • Simplify operations by reducing the need to add or remove flashboards to maintain water levels across a range of flows. • Facilitate the ability to make frequent flow changes through the system, as needed. • Consolidate safety spills by eliminating intermediate safety spills, where practical. • Increase safety site for operators.
Spills	<ul style="list-style-type: none"> • Provide accurate and accessible measurement of spillage flow rate from the lateral as feedback loop on heading operation, general lateral operation, and District water accounting. • Increase safety of operating site.

Phase I System Modernization

The first phase would concentrate on primary inflow and operational outflow locations. These are generally the primary diversion locations or headings and main or primary canal end outflow points. The type and sophistication of improvement required to meet objectives varies by site, but the general objective is to provide improved control over the water that enters the district, as informed by improved information describing the timing and amount of water leaving the district. Readily accessible measurement of inflows and outflows has several benefits, including information for operational adjustments, data for water accounting and billing, and information to support further prioritization of improvements by quantifying potential benefits.

For BWD, the primary inflow points are the Sutter-Butte Main Canal at Thermalito Afterbay which is operated by the Joint Districts Board. The Joint Board coordinates releases with the California Department of Water Resources (DWR) operations staff for daily changes in inflow to the Sutter-Butte Canal. Downstream from the heading, the Looney Gates provide upstream water level control for the Biggs Extension canal which serves Biggs-West Gridley Water District and Richvale Irrigation District. BWD is the primary operator of the Sutter-Butte Canal below the Looney Gates. Flows into the Sutter-Butte Canal are measured just downstream of the release point by DWR, and the Joint Board operates an acoustic Doppler measurement site just downstream of the Looney Gates; although its accuracy is unverified and questionable. Fluctuations in the Biggs Extension Canal⁴ can cause substantial fluctuations in flow passing to BWD (and SEWD). The Looney Gates are undersized for peak flows, thus limiting supplies to BWD, SEWD, and other downstream users. Construction of a higher capacity structure is recommended. Accurate flow measurement at primary inflow locations is also important to achieve modernization objectives because it would allow for more accurate and precise management of inflows to the distribution system.

Recommended improvements at the primary inflow location include relocation of the existing flow meter below the Looney Gates to a concrete lined section and stream gaging to calibrate measurements and verify accuracy. Remote monitoring of this site by the District manager (in addition to the Joint Board) and operators would provide improved operations and accounting.

Phase II System Modernization

The second phase of modernization would improve key control points along the main supply canal between the headings and outflows to increase conveyance efficiency. This would include main canal water level control structures and lateral headings. Existing control sites may be abandoned in some cases, re-configured, retrofitted, downsized, or retained. The addition of Phase II improvements would generally provide steadier delivery of water from the main canal to laterals and turnouts, simplify operations by adding automation and increased the ability to make flow changes, and concentrate primary routing of flow fluctuations along the main canal.

In BWD (as in most open canal systems) the Sutter-Butte canal contains primarily flashboard check structures that require adjustment whenever there is a flow change to avoid impacts to deliveries to laterals and turnouts along the canal. Without adjustment, undesirable water level fluctuations can impact these flows. In addition to impacting service, these fluctuations present challenges to water

⁴ A modernization plan has been developed for the Joint Board as part of this Regional AWMP that would seek to help remedy water level fluctuation issues in the Sutter Butte and Biggs Extension canals.

accounting. Although many of the existing main canal structures are manual flashboard structures, BWD has initiated the modernization process by replacing the Thresher Weir with automated Langemann Gates and partially automating the Onstott Weir for upstream level control.

The modernization strategy for the Sutter-Butte Main canal is to provide new check structures to pass flow fluctuations downstream while maintaining upstream water levels across a range of flows with limited water level fluctuation. In order to function over a wide range of flows, new check structures would incorporate locally automated overshot gates. For purposes of the reconnaissance level cost estimates presented herein, several capacities of check structures were conceptually designed ranging from 1,000 cfs or more (Looney Gates and Holmes Weir) to 650 cfs at the Goat Weir. The use of adjustable overshot gates provides more flexible capacity with better performance when compared to fixed crest structures and would allow the upstream water depth to be minimized to reduce seepage during rice field dry-down periods (i.e., August and September) but when deliveries for orchard irrigation or waterfowl habitat are desired. Structures with adjustable crests also allow rapid passage of flow fluctuations with little to no change in upstream water level, thus maximizing capacity and limiting issues associated with limited freeboard.

Consolidation and routing of fluctuations along one primary route increases the likelihood that they can be used to meet downstream demand and allows for simplified monitoring of system operations to inform adjustments to diversions and upstream structures to reduce spillage. The ability to route flow fluctuations effectively is currently limited for two primary reasons. First, many main canal structures are unable to quickly pass fluctuations. As a result, the use of safety spills (such as Cox Spill) that provide temporary relief are required until adjustments can be made in the main canal. Secondly, canal capacity downstream of the Cox Weir is inadequate to convey the flow rate to meet total downstream demands. To make up for this, SEWD utilizes the Sunset Pumps to augment supplies which results in suboptimal electrical bills. Increasing the capacity of the canal below the Cox Weir has been explored and in addition to eliminating pumping requirements for SEWD would provide additional flexibility to BWD from a supply perspective but would also allow SEWD to temporarily back water out of laterals into the Sutter-Butte Canal without the risk of exceeding downstream capacity.

In addition to passing flow fluctuations downstream, new automated water level control structures would enable steadier deliveries to laterals and to growers off the main canal by providing steady upstream water levels; however, upstream water level control is only part of the solution to provide steady delivery rates. The modernization process recommends improvement of lateral headings along the main canal. These improvements would include new adjustable undershot gates and downstream flow measurement. In particular, remotely-controlled automated flow control gates are recommended at the Lateral 4, Lateral 6, and Chandon Lateral headings to allow frequent adjustment of these primary laterals. Manual gates are recommended for the other headings. The recommended measurement method for lateral headings depends on the frequency of use and lateral size. In general, smaller, less frequently used laterals would ideally be measured using propeller meters mounted to the discharge end of the heading pipe. Acoustic Doppler flow meters with continuous measurement capability are recommended for larger laterals.

The improvement of check structures and lateral headings described herein would establish the Sutter-Butte Canal as the primary spill route. Figure 1 provides an overview of all proposed improvement sites in BWD, including those in Phases III and VI described in later sections.

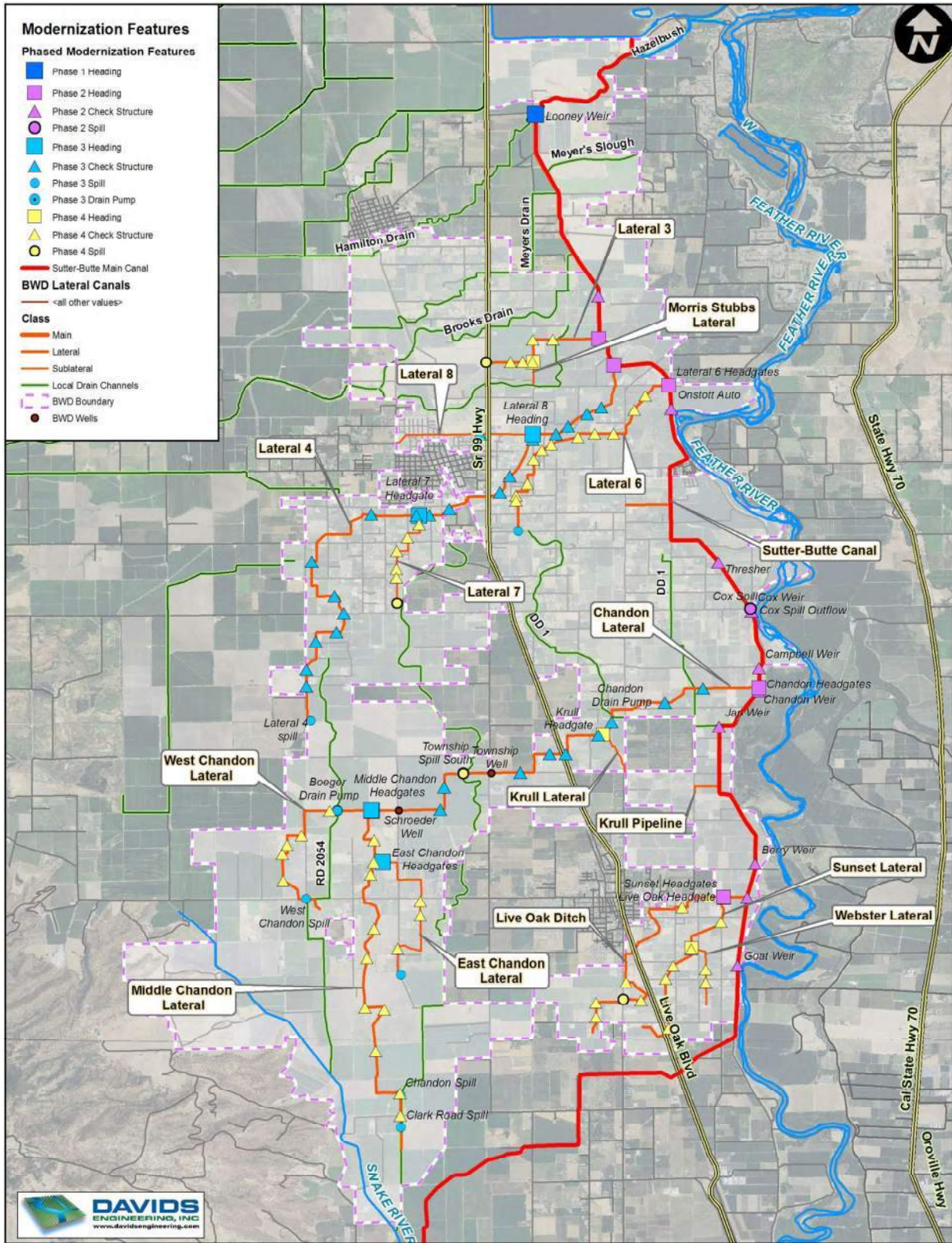

Figure 1. BWD System Modernization Phasing and Improvement Sites.

[This Page Intentionally Blank]

Phase III System Modernization

The Phase II improvements to primary control points on the main canal would enable steadier flows to laterals and allow more flexible flow changes. To effectively extend these benefits to deliveries off of the laterals, Phase III would improve primary lateral control structures and primary end spills to improve control. The proposed improvements include replacement of all existing water level control structures on the Chandon Lateral and replacement of the West, Middle and East Chandon headgates.

Additionally, Lateral 4 was identified as a candidate for improved routing of flow fluctuations and consolidation of safety spills to a single reregulation point at the Lateral 4 End Spill. Lateral 4 serves Lateral 8 and Lateral 7. With improved spill routing along Lateral 4, excesses in these sublaterals could be backed out to Lateral 4 and passed to the End Spill. Replacing existing check structures along Lateral 4 with long crested weirs would provide steady upstream water levels with no adjustment required. Additionally, because of the long weir length, a small change in head corresponds to a large change in flow enabling more rapid transfer of flow fluctuations down the system because the required change in upstream pond storage to pass the change is minimized. The Lateral 7 and 8 headgates would be improved to allow accurate and adjustable delivery. The existing end spill would be replaced with a new weir box and sharp crested weir structure to increase spill capacity (over existing) and provide accurate and consistent measurement for use by operators and for water accounting. All spills from Lateral 4 (and optimally from Lateral 7 and Lateral 8) would be discharged to the RD2054 drain channel for possible recovery at a new location on the Chandon Lateral at the existing Boeger Flume site.

A re-regulation point along the Chandon Lateral is an important component to system modernization, spill routing, and increasing the flexibility of service on all the Chandon Laterals. The objective of the improvement would be to essentially re-regulate the flow to the West Chandon and Middle Chandon Laterals using automated flow control gates. Water levels upstream of the new gates would be maintained constant in the event of surpluses or deficiencies by the Boeger weirs and a new variable frequency drive (VFD) controlled drain pump, respectively. Reconstruction of the canal upstream from the Boeger Flume to the Schroeder Well would create a level top pool which, aside from simplifying operations, would provide a limited amount of regulating storage. All excesses along the Chandon Lateral would be passed to this reregulation point and intermediate spill points (e.g. the Township Flume) would be re-operated to prevent spill. The Schroeder and Township Wells would also provide augmentation of supplies.

Phase IV System Modernization

The fourth phase would build on lateral heading flow control completed under Phase II and Phase III, and lateral water level control completed under Phase III by improving secondary control points along laterals and sublateral control points to inform and improve operations. Additionally, minor or secondary safety spills are prioritized for improvement, although some intermediate safety spills could likely not be needed and could be abandoned as check structures are improved to allow routing of flow fluctuations without causing substantial water level fluctuations, capacities are increased, and the controllability of flows at heading structures is increased. Objectives are to increase flexibility, consistency, and adequacy of supply to sublaterals; increased delivery steadiness and consistency; and concentrated routing of flow fluctuations to a measurement location providing operators with feedback to help determine the status of deliveries or the need for a change at the lateral heading to improve operations.

The fourth phase represents the final phase of system modernization to support spill reduction and possible diversion reduction, resulting in district-scale water conservation as well as increased levels of service. The final phase would complete additional improvements to: Lateral 3, Live Oak Lateral, Sunset Lateral, Webster Lateral, Krull Lateral, Lateral 7, West Chandon, Middle Chandon, and East Chandon. Additionally, Phase IV includes the improvement of six private ditch headings with new adjustable control and flow measurement. Private ditches improved include the Biggs Ditch, the Colony 3 Ditch, the Cushman Ditch, the Manzanita Lateral Heading, the Ownby Ditch Headgate, and the Krull Lateral.

Inventory of Existing Conditions

Existing conditions were characterized through consultation with district operations staff. For each site type, representative sites were selected for field inspection to obtain dimensions, coordinates, photos and operational features typical of the site type to aid in strategy development and cost estimation. Table 4 provides the site name, the site type, latitude, longitude, and a description of existing conditions for each site to be improved. Sites were assigned to one of the following categories: Inflow, Heading, Water Level Control, or Safety Spill. The sites identified may not be exhaustive.

Table 4. Inventory of Existing Conditions.

Site Name	Site Type	Latitude	Longitude	Description of Existing Conditions
Looney Weir	Water Level Control	39.436	-121.678	Two ~16ft wide AMIL gates installed in concrete structure. Approximate capacity is 900cfs.
Holmes Weir	Water Level Control	39.399	-121.665	Automated radial gate in the middle has 300 cfs capacity. 2 undershot bays on either side
Lateral 3 Headgate	Heading	39.390	-121.665	Concrete headwall with manually operated undershot gate
Lateral 4 Headgate	Heading	39.385	-121.662	Concrete structure with two 3.5-foot wide rectangular openings, 6-foot tall and 10ft long. Structure is in fair condition. Rectangular metal canal gates with operating wheels. 80 CFS capacity.
Lateral 6 Headgate	Heading	39.380	-121.651	25cfs capacity 1 36" and 1 24" diameter gate
Onstott Auto	Water Level Control	39.376	-121.651	Two automated vertical gates and four manually operated vertical gates
Thresher Weir	Water Level Control	39.344	-121.641	Two 16' Langemann gates
Cox Spill	Spill	39.335	-121.634	Automated overshot gate that maintains upstream water level or can be manually adjusted to spill.
Cox Weir	Water Level Control	39.334	-121.634	One hand-crank vertical gate and six flashboard bays.
Campbell Weir	Water Level Control	39.323	-121.633	Concrete structure with several flashboard bays
Chandon Headgate	Heading	39.319	-121.633	Four gates total in concrete headwall in fair condition. Two 4ftx6ft gates at center with a 24" and 36" undershot at sides.

Site Name	Site Type	Latitude	Longitude	Description of Existing Conditions
Chandon Weir	Water Level Control	39.318	-121.633	Concrete structure with several flashboard bays
Jap Weir	Water Level Control	39.311	-121.641	Concrete structure with several flashboard bays
Berry Weir	Water Level Control	39.283	-121.633	Concrete structure with several flashboard bays
Live Oak Headgate	Heading	39.276	-121.640	Structure in good condition
Sunset Headgate	Heading	39.276	-121.640	Structure in good condition
Pennington Weir	Water Level Control	39.276	-121.635	Eight flashboard bays
Goat Weir	Water Level Control	39.262	-121.637	Five flashboard bays
Lateral 4 Spill	Spill	39.312	-121.724	CMP weir box with 4' wide weir. 20ft of 36" CMP provides drainage.
Lateral 6 Spill	Spill	39.351	-121.682	4' wide weir box upstream from Sheldon Road Crossing is regulated using boards. Spills travel through 12" RCP to East to DD1 drain
West Chandon Spill	Spill	39.276	-121.725	Two bay concrete weir structure. 4ft wide x 3.5ft deep openings. One for spill, one for continuation of lateral. 24" steel pipes convey water from structure to spill or lateral.
East Chandon Spill	Spill	39.260	-121.706	3' wide weir box and concrete headwall with 18" diameter outlet pipe that empties to drain.
Chandon Spill	Spill	39.236	-121.706	15" diameter sluice gate and concrete headwall. Downstream piping through embankment to adjacent drain ditch
Clark Road Spill	Spill	39.229	-121.706	4ft wide weir structure with concrete headwall side spills from canal to adjacent drain channel. 18" CMP pipeline provides conveyance and free falls into drain. Pipe appears to be flow restriction
Lateral 8 Headgate	Heading	39.371	-121.679	Concrete headwall with manually operated undershot gates
Lateral 4 Weirs	Water Level Control	Several Locations		Concrete structures with flashboards
Lateral 7 Headgate	Heading	39.354	-121.019	Concrete headwall with manually operated undershot gates
Boeger Flume	Spill	39.294	-121.719	Concrete flume structure with north and south 2ft-wide flash board bays that spill to RD2054. 15hp drain recovery pump. Existing check structure ~400ft downstream

Site Name	Site Type	Latitude	Longitude	Description of Existing Conditions
West Chandon Headgate	Heading	39.294	-121.712	Concrete headwall with manually operated undershot gates
Middle Chandon Headgate	Heading	39.294	-121.712	Concrete headwall with manually operated undershot gates
Chandon Lateral Weirs	Water Level Control	Several Locations		Concrete structures with flashboards
East Chandon Headgate	Heading	39.283	-121.709	Concrete headwall with manually operated undershot gates
Lateral 3 End Spill	Spill	39.385	-121.688	Concrete structure with flashboards
Lateral 7 End Spill	Spill	39.336	-121.706	Concrete weir box with flashboards. Piping carries spill to drain.
Live Oak End Spill	Spill	39.250	-121.666	Concrete weir box with flashboards spills directly to drain channel.
Sunset Lateral End Spill	Spill	39.252	-121.651	Concrete weir box with flashboards. Piping carries spill to drain.
Morris Stub Lateral Headgate	Heading	39.385	-121.679	24" sluice gate and 24" RCP at heading, 60" wide weir in Lateral 3
Township Flume and Spill	Spill	38.301	-121.693	North and South 4ft-wide slide gates that spill to RD2056. Top of gate acts as adjustable sill for water level control
Krull Headgate	Heading	39.309	-121.664	Concrete headwall with manually operated undershot gate
Webster Lateral Headgate	Heading	39.265	-121.646	Concrete headwall with manually operated undershot gates
Lateral 3 Weirs	Water Level Control	Several Locations		Concrete structures with flashboards
Lateral 7 Weirs	Water Level Control	Several Locations		Concrete structures with flashboards
Lateral 6 Weirs	Water Level Control	Several Locations		Concrete structures with flashboards
West Chandon Weirs	Water Level Control	Several Locations		Concrete structures with flashboards
Middle Chandon Weirs	Water Level Control	Several Locations		Concrete structures with flashboards

Site Name	Site Type	Latitude	Longitude	Description of Existing Conditions
East Chandon Weirs	Water Level Control	Several Locations		Concrete structures with flashboards
Sunset Weirs	Water Level Control	Several Locations		Concrete structures with flashboards
Live Oak Weirs	Water Level Control	Several Locations		Concrete structures with flashboards
Webster Weirs	Water Level Control	Several Locations		Concrete structures with flashboards

System Modernization Physical and Operational Improvements

Level 1 and 2 Improvements

For each site, improvement is split into two levels, Level 1 and Level 2. Level 1 improvements typically include fundamental infrastructure and measurement enhancements that are manually operated or read, or locally automated, and designed as SCADA-Ready⁵. These improvements include, but not limited to new, manually adjustable heading gates; long crested weirs; locally automated overshot gates; and measurement devices such as weirs, acoustic Doppler flow meters, and propeller meters. Level 2 improvements build upon Level 1 improvements by automating certain additional features, adding electronic sensors, installing on-site digital display of flow rate or other parameters, or adding remote monitoring or control through a Supervisory Control and Data Acquisition System (SCADA). Level 1 improvements are stand-alone, while Level 2 improvements generally require Level 1 to be completed prior to or at the same time. The progression from level 1 to level 2 improvements provides the flexibility to complete Level 1 (which has significant benefits on its own) while assessing the benefits of SCADA, further prioritizing sites, establishing a SCADA base station, and gradually implementing potentially more complex and technically intricate remote control sites.

Although Level 2 is not universally required to be completed to obtain significant benefits, several sites would substantially benefit. Two examples of this are:

1. Remotely located end spill sites not frequently visited by operators. Remote monitoring would reduce travel time potentially enabling additional flow changes, as needed.
2. Automated flow control gates at headings with substantial upstream water level fluctuations; however, assuming water level control structures are installed, the flow control device could have little additional benefit until remote control is added to allow for flow adjustments.

In some cases, there could be capital cost savings by completing Level 1 and Level 2 improvements at the same time.

⁵ “SCADA-Ready” describes a package of hardware and/or software that communicates and operates locally but has been specifically designed and installed to readily accept a data transmission and receiving device (e.g. radio, cellular modem, etc.) and to provide remote communication with an established base station and SCADA human machine interface (HMI).

Table 5 provides a description of the improvements proposed for each site, the objective of the improvements and estimated Phase I and Phase II improvement costs. For each site and level of improvements, upfront capital costs and annualized capital, operations, and maintenance costs are provided. All costs are subject to revision following refinement of site improvements as informed by more detailed review and design.

Table 5. Site Improvement Matrix.

Site Name	Site Type	Description of Operational Objective with Improvements	Level 1 Modernization and Enhancement	Capital Cost (\$)	Annual Cost (\$/yr)	Level 2 Modernization and Enhancement	Capital Cost (\$)	Annual Cost (\$/yr)
SCADA Office Base Station		Allows remote monitoring of measured parameters at SCADA equipped sites. Also allows remote control and adjustment of set points at automated water level or flow control sites. Provides for storage of data and interface for developing comprehensive status reports, usage statistics, and monitoring information for improved water management, accounting and reporting.	Level 1 Modernization and Enhancement does not include SCADA at sites; therefore, base station is not required.	\$0	\$0	Furnish and install one desktop personal computer, including: processor, monitor, keyboard, mouse, drivers, USB, RS232, Ethernet, communication ports, cables, adapters, modems, printer, operating system software and HMI software. Base station spread spectrum radio, mast, and antenna for communication with remote sites. Five hardened laptops and vehicle mounts for operator/in-field use. Vehicle-mounted radios and antennas for remote communications and monitoring of sites.	\$138,063	\$17,039
Spare Equipment		Minimize down time associated with simple equipment maintenance or malfunctions and/or procurement of site or system specific hardware.	Small inventory of site and system specific equipment that is critical for proper operation of improvements.	\$23,692	\$2,913		\$0	\$0
Phase 1 Modernization - Improvement of Primary Inflow Locations and Primary Operational Outflow Locations								
Looney Weir	Water Level Control	Provide upstream level control over full range of operational flow rates in Sutter Butte Main Canal to ensure steady deliveries to RD833 Drain and Greenhouse Gates.	See Joint Board Improvement Description. Remove existing AMIL gates and construct new structure with minimum capacity of 1,000 cfs.	\$493,947	\$27,057	Add upstream water level sensor and integrate with SCADA system to allow monitoring of water levels	\$7,400	\$700
Sutter-Butte Main Canal Inflow	Flow Measurement	Provide Joint-Board operators, BWD managers, and BWD canal operators with accurate inflow to the Sutter-Butte Main Canal for improved water allocation, accounting and general management.	Construct concrete lined control section at location of existing meter d/s of Looney Weir. Perform velocity index calibration of existing meter and install walkway over sensor for verification purposes. Replace meter as necessary.	\$55,400	\$5,300	Upgrade and reinstall existing solar power site, flow display and communication hardware and integrate with SCADA system to allow remote monitoring of flow rate.	\$5,900	\$600
Phase 2 Modernization - Improvement of Main Canal Primary Control Points								
Holmes Weir	Water Level Control	Provide upstream level control over full range of operational flow rates in Sutter Butte Main Canal to ensure steady deliveries to upstream lateral headings and deliveries, and pass fluctuations downstream.	Replace existing structure with fully automated upstream water level control gate. New structure capacity is 1,000 cfs.	\$1,218,889	\$66,767	Integrate with SCADA system to allow remote manual adjustment of set points and monitoring of water levels and gate function.	\$7,400	\$700
Lateral 3 Headgate	Heading		Install ADVM downstream from gates in straight section of channel. Perform velocity index calibration. Install digital display of flow rate at heading gates to inform adjustments. Flow measurement site will be SCADA-Ready.	\$26,400	\$2,900	Due to deteriorating concrete, replace existing concrete structure with new structure and new undershot gates. Install communication hardware and integrate with SCADA system to allow remote monitoring.	\$23,300	\$1,800
Lateral 4 Headgate	Heading	Provide accurate, repeatable and consistent flow to supply deliveries downstream of the lateral heading.	Install ADVM downstream from gates in straight section of channel. Perform velocity index calibration. Install digital display of flow rate at heading gates to inform adjustments. Flow measurement site will be SCADA-Ready.	\$26,400	\$2,900	Due to deteriorating concrete, replace existing concrete structure with new structure and new automated flow control gates. Install communication hardware and integrate with SCADA system to allow remote monitoring and control of gate function and set points.	\$106,700	\$7,800
Lateral 6 Headgate	Heading		Install ADVM downstream from gates in straight section of channel. Perform velocity index calibration. Install digital display of flow rate at heading gates to inform adjustments.	\$26,400	\$2,900	SCADA system to allow remote monitoring and control of gate function and set points.	\$106,700	\$7,800
Onstott Auto	Water Level Control	Provide upstream level control over full range of operational flow rates in Sutter Butte Main Canal to ensure steady deliveries to upstream lateral headings and deliveries, and pass fluctuations downstream.	Replace existing structure with fully automated upstream water level control gate. New structure capacity is 950cfs.	\$1,208,236	\$66,183	Integrate with SCADA system to allow remote manual adjustment of set points and monitoring of water levels and gate function.	\$7,400	\$700

Site Name	Site Type	Description of Operational Objective with Improvements	Level 1 Modernization and Enhancement	Capital Cost (\$)	Annual Cost (\$/yr)	Level 2 Modernization and Enhancement	Capital Cost (\$)	Annual Cost (\$/yr)
Thresher Weir	Water Level Control		Integrate existing automated upstream water level control structures with the SCADA system to allow remote monitoring and remote manual adjustment of gate set points.	\$7,400	\$700	None	\$0	\$0
Cox Spill	Spill	Provide site for operational spillage to return to the Feather River. Enable remote monitoring of spillage and gate operation to improvement management.	Integrate existing measurement site with SCADA system.	\$11,800	\$1,200	None	\$0	\$0
Cox Weir	Water Level Control	Provide upstream level control over full range of operational flow rates in Sutter Butte Main Canal to ensure steady deliveries to upstream lateral headings and deliveries, and pass fluctuations downstream.	Replace existing structure with fully automated upstream water level control gate. New structure to have a maximum capacity of at least 865 cfs.	\$997,297	\$54,629	Integrate with SCADA system to allow remote manual adjustment of set points and monitoring of water levels and gate function.	\$7,400	\$700
Campbell Weir	Water Level Control		Replace existing structure with fully automated upstream water level control gate. New structure to have a maximum capacity of at least 825 cfs.	\$908,043	\$49,740	Integrate with SCADA system to allow remote manual adjustment of set points and monitoring of water levels and gate function.	\$7,400	\$700
Chandon Headgate	Heading	Provide accurate, repeatable and consistent flow to supply deliveries downstream of the lateral heading.	Install ADVM downstream from gates in straight section of channel. Perform velocity index calibration. Install digital display of flow rate at heading gates to inform adjustments.	\$26,400	\$2,900	Replace existing concrete structure with new, higher capacity concrete structure. Add automated gate with sufficient capacity for daily adjustments and manual gate for typical base flow. Install solar power system, digital display, PLC and integrate with SCADA system to allow remote manual adjustment of set points and monitoring of flow rate, water levels and gate function.	\$189,740	\$13,560
Chandon Weir	Water Level Control		Replace existing structure with fully automated upstream water level control gate. New structure to have a maximum capacity of at least 800 cfs.	\$899,687	\$49,282	Integrate with SCADA system to allow remote manual adjustment of set points and monitoring of water levels and gate function.	\$7,400	\$700
Jap Weir	Water Level Control	Provide upstream level control over full range of operational flow rates in Sutter Butte Main Canal to ensure steady deliveries to upstream lateral headings and deliveries, and pass fluctuations downstream.	Replace existing structure with fully automated upstream water level control gate. New structure to have a maximum capacity of at least 765 cfs.	\$797,122	\$43,664	Integrate with SCADA system to allow remote manual adjustment of set points and monitoring of water levels and gate function.	\$7,400	\$700
Berry Weir	Water Level Control		Replace existing structure with fully automated upstream water level control gate. New structure to have a maximum capacity of at least 725 cfs.	\$797,122	\$43,664	Integrate with SCADA system to allow remote manual adjustment of set points and monitoring of water levels and gate function.	\$7,400	\$700
Live Oak Headgate	Heading	Provide accurate, repeatable and consistent flow to supply deliveries downstream of the lateral heading.	Install ADVM downstream from gates in straight section of channel. Perform velocity index calibration. Install digital display of flow rate at heading gates to inform adjustments. Site will be SCADA-Ready	\$26,400	\$2,900	Install communication hardware and integrate with SCADA system to allow remote monitoring.	\$5,900	\$600
Sunset Headgate	Heading		Install ADVM downstream from gates in straight section of channel. Perform velocity index calibration. Install digital display of flow rate at heading gates to inform adjustments.	\$26,400	\$2,900		\$5,900	\$600
Pennington Weir	Water Level Control	Provide upstream level control over full range of operational flow rates in Sutter Butte Main Canal to ensure steady deliveries to upstream lateral headings and deliveries, and pass fluctuations downstream.	Replace existing structure with fully automated upstream water level control gate. New structure to have a maximum capacity of at least 685 cfs.	\$797,122	\$43,664	Integrate with SCADA system to allow remote manual adjustment of set points and monitoring of water levels and gate function.	\$7,400	\$700

Site Name	Site Type	Description of Operational Objective with Improvements	Level 1 Modernization and Enhancement	Capital Cost (\$)	Annual Cost (\$/yr)	Level 2 Modernization and Enhancement	Capital Cost (\$)	Annual Cost (\$/yr)
Goat Weir	Water Level Control		Replace existing structure with fully automated upstream water level control gate. Integrate with SCADA system to allow remote manual adjustment of set points and monitoring of water levels and gate function. New structure to have a maximum capacity of at least 650 cfs.	\$797,122	\$43,664	Integrate with SCADA system to allow remote manual adjustment of set points and monitoring of water levels and gate function.	\$7,400	\$700
Phase 3 Modernization - Improvement of Lateral Primary Control Points and Spill Routing								
Lateral 4 Spill	Spill	Provide accurate and accessible measurement of spillage flow rate from the lateral as feedback loop on heading operation, general lateral operation, District water accounting and to inform operation of Boeger re regulation point.	Replace weir box with new. Install sharp crested weir plate and mount custom staff gage calibrated to report spill flow rate based on the depth of water above the weir crest.	\$8,700	\$700	Install pressure transducer in new stilling well upstream of spill box to measure head on weir. Perform calibration of weir. Install communication hardware and integrate with SCADA system to allow remote monitoring.	\$15,400	\$1,500
Lateral 6 Spill	Spill		Install weir boards in existing spill box to control spill rate. Install weir box on downstream end of existing pipe and install open channel propeller meter. Install trash rack at inlet. Site will be SCADA-Ready	\$19,100	\$1,700	Install communication hardware and integrate with SCADA system to allow remote monitoring.	\$11,800	\$1,200
West Chandon Spill	Spill		Replace weir box with new. Install sharp crested weir plate and mount custom staff gage calibrated to report spill flow rate based on the depth of water above the weir crest.	\$8,700	\$700	Install pressure transducer in new stilling well upstream of spill box to measure head on weir. Perform calibration of weir. Install communication hardware and integrate with SCADA system to allow remote monitoring.	\$15,400	\$1,500
East Chandon Spill	Spill	Provide accurate and accessible measurement of spillage flow rate from the lateral as feedback loop on heading operation, general lateral operation, and District water accounting.	Replace weir box with new. Install sharp crested weir plate and mount custom staff gage calibrated to report spill flow rate based on the depth of water above the weir crest.	\$8,700	\$700	Install pressure transducer in new stilling well upstream of spill box to measure head on weir. Perform calibration of weir. Install communication hardware and integrate with SCADA system to allow remote monitoring.	\$15,400	\$1,500
Chandon Spill	Spill		Modify operations to pass excesses to Clark Road Spill. Operate Chandon Spill on emergency basis only.	\$0	\$0	None	\$0	\$0
Clark Road Spill	Spill		Remove existing concrete weir box and CMP. Install longer overpour weir with fixed, sharp crest; install drain gate and larger discharge piping to ensure free flow over weir. Install custom staff gage calibrated to report spill flow rate based on the depth of water above the weir crest.	\$8,700	\$700	Install pressure transducer in new stilling well upstream of spill box to measure head on weir. Perform calibration of weir. Install communication hardware and integrate with SCADA system to allow remote monitoring.	\$15,400	\$1,500
Lateral 8 Headgate	Heading	Provide accurate, repeatable and consistent flow to supply deliveries downstream of the lateral heading.	Install weir box on downstream end of existing pipe and install open channel propeller meter. Install trash rack at inlet. Replace heading gate as necessary to provide adjustable and reliable control. Site will be SCADA-Ready.	\$26,400	\$2,400	Replace existing gate and structure with new automated flow control gate. Install communication hardware and integrate with SCADA system to allow remote monitoring and control of gate function and set points.	\$44,800	\$3,200
Lateral 4 Weirs	Water Level Control	Maintain upstream water level for constant upstream deliveries and to route any flow fluctuations down Lateral 4 to the end spill for potential recapture at the proposed Boeger Flume re Regulation site.	Replace all water level control structures in Lateral 4 from the heading to the spill with LCWs. Total of 18 structures.	\$833,800	\$53,200	None	\$0	\$0
Lateral 7 Headgate	Heading	Provide accurate, repeatable and consistent flow to supply deliveries downstream of the lateral heading.	Install weir box on downstream end of existing pipe and install open channel propeller meter. Install trash rack at inlet. Replace heading gate as necessary to provide adjustable and reliable control. Site will be SCADA-Ready.	\$26,400	\$2,400	Replace existing gate and structure with new automated flow control gate. Install communication hardware and integrate with SCADA system to allow remote monitoring and control of gate function and set points.	\$44,800	\$3,200

Site Name	Site Type	Description of Operational Objective with Improvements	Level 1 Modernization and Enhancement	Capital Cost (\$)	Annual Cost (\$/yr)	Level 2 Modernization and Enhancement	Capital Cost (\$)	Annual Cost (\$/yr)	
Boeger Flume Re Regulation	Flow Control	Re regulate flow in the Chandon Lateral upstream of the West and Middle Chandon Headgates to provide constant flowrate to downstream deliveries. Excesses in supply are spilled instead of being passed downstream and deficiencies are met by extracting drain water from the 2054 Drain.	Replace existing pump with new variable speed drive unit with heading to maintain water level in Chandon Lateral. Relocate heading of West Chandon to just downstream from flume with undershot gates and raise banks upstream from flume approximately 0.7miles to the Schroeder Well to create level-top pool. Install flap gates in existing flashboard bays in walls of flume to maintain water level and pass excesses to drain.	\$232,240	\$16,781	Automate flow control gates and new heading of West Chandon to allow remote control. Install solar power system, PLC, communication hardware and integrate with SCADA system to allow remote monitoring of levels, flow rates, and pump operation.	\$57,700	\$3,391	
West Chandon Headgate	Heading	Provide accurate, repeatable and consistent flow to supply deliveries downstream of the lateral heading.	See description for Boeger Flume Re Regulation. New flow control structure for West Chandon lateral will be just downstream of Boeger Flume and consist of a new concrete headwall with two undershot gates for flow control. Add ADVM downstream and digital flow display at gates. Site will be SCADA-Ready.	\$0	\$0	Automate flow control gates and new heading of West Chandon to allow remote control. Install solar power system, PLC, communication hardware and integrate with SCADA system to allow remote monitoring of levels, flow rates, and pump operation.	\$0	\$0	
Middle Chandon Headgate	Heading	Provide accurate, repeatable and consistent flow to supply deliveries downstream of the lateral heading.	See Boeger Flume re regulation improvement description. Install new heading structure with adjustable control. Install ADVM downstream of gates to measure flow. Site will be SCADA-Ready.	\$0	\$0	None	\$0	\$0	
Chandon Lateral Weirs	Water Level Control	Maintain upstream water level for constant upstream deliveries while quickly routing flow changes down the lateral to meet downstream deliveries, or passing excesses to the proposed re regulation point at Boeger Flume.	Replace all water level control structures in Chandon Lateral from the heading to Boeger spill with combination water level control structures. Total of nine structures	\$1,463,900	\$108,100	None	\$0	\$0	
East Chandon Headgate	Heading	Provide accurate, repeatable and consistent flow to supply deliveries downstream of the lateral heading.	Install long crested weir at split of Middle Chandon and East Chandon. Retain existing undershot gates and install measurement downstream from East Chandon gates with digital flow rate display at heading gates.	\$79,500	\$6,300	Replace existing gate and structure with new automated flow control gate. Install communication hardware and integrate with SCADA system to allow remote monitoring and control of gate function and set points.	\$5,900	\$600	
East Chandon Spill	Spill	No measurement. 3' wide weir box and concrete headwall with 18" diameter outlet pipe that empties to drain. Turnout immediately upstream	Install weir box on downstream end of existing pipe and install open channel propeller meter. Install trash rack at inlet. Site will be SCADA-Ready	\$19,100	\$1,700	Add communication hardware to measurement site and integrate with SCADA system to provide real-time monitoring of flow rate and water level.	\$11,800	\$1,200	
Phase 4 Modernization - Improvement of Lateral Secondary Points, Sublateral Control Points and Secondary Spill Points									
Lateral 3 End Spill	Spill	Provide accurate and accessible measurement of spillage flow rate from the lateral as feedback loop on heading operation, general lateral operation, and District water accounting.	Replace weir box with new concrete structure. Install sharp crested weir plate and mount custom staff gage calibrated to report spill flow rate based on the depth of water above the weir crest.	\$8,700	\$700		\$15,400	\$1,500	
Lateral 7 End Spill	Spill			\$8,700	\$700		\$15,400	\$1,500	
Live Oak End Spill	Spill				\$8,700	\$700	Install pressure transducer in new stilling well upstream of spill box to measure head on weir. Perform calibration of weir. Install communication hardware and integrate with SCADA system to allow remote monitoring.	\$15,400	\$1,500
Sunset Lateral End Spill	Spill				\$8,700	\$700		\$15,400	\$1,500
Morris Stub Lateral Headgate	Heading	Provide accurate, repeatable and consistent flow to Morris Stub Lateral II needed to supply deliveries.	Morris Stub Lateral is currently used as a drain channel due to the absence of deliveries. No improvement is recommended at this time.	\$0	\$0	None	\$0	\$0	

Site Name	Site Type	Description of Operational Objective with Improvements	Level 1 Modernization and Enhancement	Capital Cost (\$)	Annual Cost (\$/yr)	Level 2 Modernization and Enhancement	Capital Cost (\$)	Annual Cost (\$/yr)
Township Flume and Spill	Spill	Convey water across Morrison Slough and enable accurate and repeatable deliveries to the Slough for downstream deliveries when needed.	Discontinue use of existing slide spill gates, but retain for emergency purposes. All spills are routed to proposed Boeger re regulation site. Install new sluice gate outlet with inline propeller meter.	\$19,100	\$1,700	Install solar power system, communication hardware and integrate flow measurement site with SCADA system to allow remote monitoring of flow being delivered to drain.	\$11,800	\$1,200
Krull Headgate	Heading	Provide accurate, repeatable and consistent flow to supply deliveries downstream of the lateral heading.	Replace check structure in Chandon Lateral with LCW. Install new head gates with flow measurement.	\$26,400	\$2,400	Install communication hardware and integrate with SCADA system to allow remote monitoring.	\$11,800	\$1,200
Webster Lateral Headgate	Heading		Replace gates in Sunset Lateral with long crested weir, install measurement downstream from existing Webster lateral heading.	\$26,400	\$2,400	Install communication hardware and integrate with SCADA system to allow remote monitoring.	\$11,800	\$1,200
Lateral 3 Weirs			Replace five existing check structures with LCWs.	\$111,000	\$7,000	None	\$0	\$0
Lateral 7 Weirs			Replace five existing check structures with LCWs.	\$111,000	\$7,000	None	\$0	\$0
Lateral 6 Weirs			Replace eleven existing check structures with LCWs.	\$244,200	\$15,400	None	\$0	\$0
West Chandon Weirs			Replace five existing check structures with LCWs.	\$111,000	\$7,000	None	\$0	\$0
Middle Chandon Weirs	Water Level Control	Maintain constant upstream deliveries by maintaining the desired upstream water level in the supply canal over a range of canal flow rates. Simplify operations by reducing the need to add or remove flashboards, and increase the rate at which flow changes can be passed through the system	Replace ten existing check structures with LCWs.	\$409,000	\$26,000	None	\$0	\$0
East Chandon Weirs			Replace three existing check structures with LCWs.	\$66,600	\$4,200	None	\$0	\$0
Sunset Weirs			Replace six existing check structures with LCWs.	\$133,200	\$8,400	None	\$0	\$0
Live Oak Weirs			Replace six existing check structures with LCWs.	\$133,200	\$8,400	None	\$0	\$0
Webster Weirs			Replace two existing check structures with LCWs.	\$44,400	\$2,800	None	\$0	\$0
Biggs Ditch	Private Ditch			\$19,100	\$1,700		\$11,800	\$1,200
Colony 3	Private Ditch			\$19,100	\$1,700		\$11,800	\$1,200
Cushman Ditch	Private Ditch			\$19,100	\$1,700		\$11,800	\$1,200
Manzanita Lateral Headgate	Private Ditch	Provide accurate, repeatable and consistent flow to private ditch to supply deliveries downstream and to improve water accounting.	Install weir box on downstream end of existing pipe at heading and install open channel propeller meter. Replace heading gate as necessary to provide adjustable and reliable control. Site will be SCADA-Ready.	\$19,100	\$1,700		\$11,800	\$1,200
Ownby Ditch Headgate	Private Ditch			\$19,100	\$1,700		\$11,800	\$1,200
Krull Lateral	Private Ditch			\$19,100	\$1,700		\$11,800	\$1,200

[This Page Intentionally Blank]

System Modernization Costs

The total combined cost (all phases, Level 1 and Level 2) of system modernization is estimated to be approximately \$14,207,000, with annualized estimated costs of \$872,000. Individual costs by modernization phase range from a low of \$563,000 to a high of \$9,103,000 for Phase 1 and Phase 2, respectively. Costs are further summarized in Table 6. Additionally, the costs of a SCADA base station and mobile operator terminals that would form the backbone of the District SCADA system have been estimated, along with the cost of spare equipment to be kept on hand to repair or replace individual site components due to theft, vandalism, or other failure. The cost of the SCADA base station may be drastically reduced, or eliminated, if the district is able to ‘piggy-back’ on to and expand the existing SCADA network current owned and operated by the Joint Water Districts Board.

Table 6. Summary of Estimated Capital and Annualized Costs.

Modernization Phase	Level 1		Level 2	
	Capital Cost (\$)	Annual Cost (\$/yr)	Capital Cost (\$)	Annual Cost (\$/yr)
Phase I - Improvement of Primary Inflow Locations and Primary Operational Outflow Locations	\$549,347	\$32,357	\$13,300	\$1,300
Phase II - Improvement of Main Canal Primary Control Points	\$8,598,241	\$480,555	\$504,840	\$38,460
Phase III - Improvement of Lateral Primary Control Points and Spill Routing	\$2,735,240	\$195,381	\$238,400	\$18,791
Phase IV - Improvement of Lateral Secondary Points, Sublateral Control Points and Secondary Spill Points	\$1,470,300	\$95,500	\$97,000	\$9,600
Total Cost =	\$13,353,128	\$803,793	\$853,540	\$68,151
SCADA Office Base Station	-	-	\$138,063	\$17,039
Spare Parts	\$23,692	\$2,913	-	-

Potential Benefits

The system modernization plan described herein represents comprehensive improvements to the district’s distribution system, adding several automated control structures, improved measurement, new heading structures, re-regulation points, and SCADA. Flow paths targeted under of the system modernization project are:

- Operational spillage,
- Tailwater,
- Drainage Outflows, and
- Diversions

Improvements would allow reduced operational spillage and reduced deliveries due to increased delivery efficiency, which could reduce on-farm tailwater and, in some cases, deep percolation. Reduced deliveries result in reduced diversions, which results in corresponding reductions in spillage

and drainage outflows. Available water not diverted remains in storage and could potentially meet local, regional, or statewide water management objectives.

Through implementation of the system modernization program (Phases I - IV and Levels 1 and 2), it is estimated that approximately 20 to 50 percent⁶ of existing operational spillage could be conserved annually, or between approximately 2,000 and 5,000 af per year. This conserved water could be used to:

- Increase local water supply,
- Increase local water delivery flexibility,
- Increase in-stream flow, and/or
- Improve water quality

Each phase provides varying levels of anticipated benefit with the first two phases likely seeing greater benefit than the third and fourth due to the greater number of sites improved, establishment of primary spill routing, and improvement of control structures that are located higher in the system (i.e. have control over a larger proportion of the total water diverted). The marginal estimated range of percent reduction in spillage and boundary outflow achieved by completing phases is described below:

1. Phase I: 1 to 2 percent reduction; 100 to 200 af of the targeted flow path
2. Phase II: 12 to 25 percent reduction; 1,200 to 2,500 af of the targeted flow path
3. Phase III: 5 to 15 percent reduction; 500 to 1,500 af of the targeted flow path
4. Phase IV: 2 to 8 percent reduction; 200 to 800 af of the targeted flowpath

Net Benefit Analysis

The district is currently implementing associated EWMPs at locally cost-effective levels. BWD has not used its full allocation in recent years, and thus would not achieve cost savings through additional conservation. The estimated implementation cost per unit of water conserved is presented in Table 7. In the table, annualized costs of the SCADA base station are distributed across phases based on the relative magnitude of annualized costs for each phase. Currently, the unit cost of conservation exceeds the potential monetary savings. As a result, further implementation of the system modernization project is not locally cost effective at this time. In the future, it is anticipated that the costs and estimated benefits of this improvement project will be evaluated as additional information becomes available.

⁶ Potential spillage reduction was based in part on information from the technical memorandum “Spillage Reduction- Monitoring and Verification” published by the Agricultural Water Management Council and partly on experience with local conditions and judgment. Reductions in tailwater can also be assumed to some degree given the improved delivery steadiness, flow measurement, and control that this project enables.

Table 7. Estimated Implementation Cost per Unit of Water Conserved.

Modernization Phase	Annual Cost, Levels 1 and 2 (\$/yr)	Conserved Water Range (af/yr)	Conservation Cost (\$/af)
Phase I - Improvement of Primary Inflow Locations and Primary Operational Outflow Locations	\$34,427	100 to 200	\$172 to \$344
Phase II - Improvement of Main Canal Primary Control Points	\$530,891	1,200 to 2,500	\$212 to \$442
Phase III - Improvement of Lateral Primary Control Points and Spill Routing	\$219,073	500 to 1,500	\$146 to \$438
Phase IV - Improvement of Lateral Secondary Points, Sublateral Control Points and Secondary Spill Points	\$107,505	200 to 800	\$134 to \$538
Totals	\$891,896	2,000 to 5,000	\$178 to \$446

Project 2: Boundary Outflow and Primary Spill Measurement and Drain Water Recovery Project

Project Description

Two improvement packages are described in this section: Boundary Flow and Primary Spill Measurement, and Drain Water Recovery. Both of these projects have similar objectives, as described in Table 8. The project summaries provided in this attachment include an inventory of existing or potential sites that fall into one of the classifications described in Table 9.

For each site, conceptual designs were developed to meet the objectives. A total of seven boundary outflow locations, five boundary inflow sites, and 17 internal spill sites, two internal inflow sites, and two drain water recovery sites were identified for improvement under these two improvement packages. The selected sites (shown in Figure 2) were identified as high priority through consultation with district personnel or identified as likely high use sites based on their position in the distribution system, such as at the end of main canals or primary laterals. Several additional spill sites were identified but not included in this improvement package because of their perceived low volume or infrequent use. Recommended improvement sites are subject to revision following refinement of prioritization criteria and more detailed review and analysis.

Table 8. Objectives of Boundary Outflow and Primary Spill Measurement and Drain Water Recovery Projects.

Objective	Boundary Flow and Primary Spill Measurement	Drain Water Recovery
Improve Water Use Efficiency	Measurement of operational spillage and drainage flows can be used to make better informed system adjustments that can lead to reduced spillage and possibly a reduction in total demands. Reduced spillage and reduced tailwater can lead to reduced diversions.	Reuse of operational spillage and tailwater results in decreased required diversions. Available water not diverted remains in storage and could potentially be available to meet unmet demands or for transfer.
Develop Water Use Data	Measurement of boundary outflows and primary spillage provides the data necessary to quantify surface water leaving district, better define unmeasured flows (such as deep percolation), determine areas of high loss, characterize operational efficiencies, and aid in prioritization of improvements.	
Support Reporting	Measurement of spillage, boundary flows and recovered drainwater provides information relating to water supply, water use, water quality, environmental benefits, etc. Measurement also supports the district in responding to potential inquiries from landowners regarding water supply, water use, and historical trends.	
Increase Operational Efficiency	Measurement of spillage enables operators to make corresponding adjustments at lateral headings or at the diversion to reduce spillage or total diversions. Measurement provides early detection of end canal conditions (high or low) that may be impacting delivery service.	Recovering drain water enables operators to meet demands more quickly and flexibly. Measurement will inform adjustments, maximizing drainwater extraction, minimizing diversions and minimizing spillage.

Table 9. Site Type Classifications.

Site Type Classification	Description	Improvement Package
Boundary Inflow	Flows entering the District boundaries and providing the availability of increased supply.	Boundary Flow and Primary Spill Measurement
Boundary Outflow	Flows leaving the District boundaries and representing excess inflows, intentional releases to satisfy obligations to meet out-of-District demands, or water management issues.	Boundary Flow and Primary Spill Measurement
Internal Outflow	Flows intentionally discharged from District canals to drainage channels for downstream delivery or possible recapture (e.g. deliveries to Secondary).	Boundary Flow and Primary Spill Measurement
Internal Inflow	Additional supply entering the District from within its boundaries. (e.g. groundwater wells).	Boundary Flow and Primary Spill Measurement
Internal Spill	Excesses in supply canals that are discharged to drain channels through safety spill structures.	Boundary Flow and Primary Spill Measurement
Drain Water Recovery (Pump)	Recapture of drain water via pump as it passes through the District. Recaptured water may be spillage or tailwater from neighboring Districts, or from internal sources.	Drain Water Recovery

Recommended measurement devices for the boundary and spill flows vary by site type, site conditions and existing infrastructure or proposed infrastructure. Additionally, the intensity of use (rate and duration) relative to other sites, and the importance of the site to meeting the objectives also factor into the selection of measurement devices. In total, four measurement strategies were developed based on unique conditions. In general, it is recommended that improvement projects or phased modernization employ the same device, or a limited selection of devices, throughout the district to maintain consistency in reporting, accuracy, and operations. This also simplifies training of new employees, maintenance protocols, and troubleshooting, as well as minimizes the required spare parts. The four measurement strategies are described in Table 10.

Measurement of drain channels often presents unique challenges not often experienced in distribution canals. These include, but are not limited to: inconsistent cross sections with heavy vegetative growth, widely fluctuating flows including storm water runoff, are not typically maintained, higher than normal trash loads, below grade, low hydraulic gradients, and may be subject to additional environmental regulations.

Drain water recovery improvement recommendations focus on providing a reliable and flexible supply that can be monitored by the operators and manipulated when needed. The amount of drain water recovery is limited to available drain flows, but improvements seek to maximize its use. Effective recovery sites require: 1) infrastructure to check-up drain flows for extraction, 2) extraction device with flexible control, 3) monitoring and measurement of extraction, and 4) infrastructure or equipment in canal to provide feedback for control logic and pass recovered water to deliveries.

[This Page Intentionally Blank]

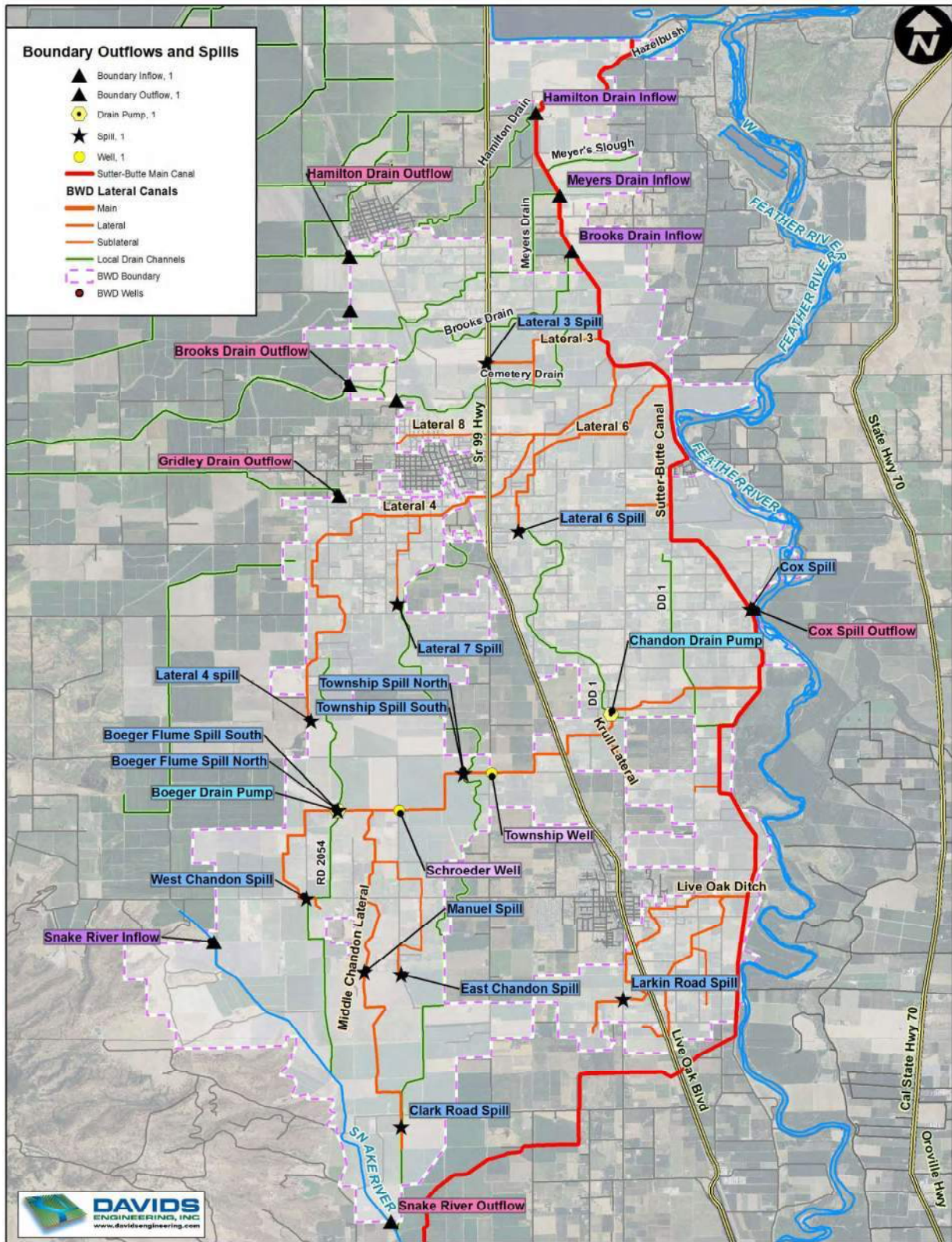

Figure 2. BWD Boundary Outflow, Primary Spills and Drain Water Recovery Sites.

[This Page Intentionally Blank]

Table 10. Descriptions of Measurement Devices and Associated Advantages and Limitations.

Measurement Device	Measurement Method	Advantages	Limitations
Acoustic Doppler Meter	Doppler technology measures water velocity. Velocity X Area = Flow rate	High accuracy depending on siting. Generally little calibration and are SCADA-Ready. No moving parts.	Requires power source. Requires a stable cross section and uniform flow velocities. Weeds or other obstructions impact accuracy.
Open Channel Propeller Meter	Flow through pipe rotates propeller. Rotational velocity is related to water velocity. Velocity X Area = Flow rate	Simple and relatively inexpensive device. Can provide good accuracy depending on siting. Effective in submerged situations. District staff is familiar with technology.	Air pockets, turbulence, weeds or other trash may cause inaccuracies. Moving parts require annual maintenance. Requires full pipe.
Sharp Crested Weir	For a given weir length, flow is determined by depth of flow over weir crest.	Simple and inexpensive device. Easily adaptable to majority of existing spill structures. Good accuracy depending on siting. Minimal maintenance required.	Accuracy limited to measurement of head on weir. Requires free fall of flow over weir and uniform velocities.
RemoteTracker ⁷	Portable device measures water velocity in pipeline. Velocity X Area = Flow rate	Portable. Highly accurate and simple operation. Incorporates remote communications and water delivery records.	Subject to inaccuracies caused by air pockets or turbulence. Requires full pipe. Unit cost is high. Does not provide continuous measurement.

Several of the boundary flow, spills, and drain water recovery sites are incorporated to some degree in the Modernization package as measurement of outflows is a critical component, as is reregulation and augmentation of supplies using drain water. There are several spill sites recommended for improvement in this package that are not included in the modernization package. This is because the modernization package helps define new spill routing opportunities and consolidates multiple spill sites or eliminates the need for intermediate operational spills, other than in emergency situations.

In most cases, selected spill sites are existing sites that require only minimal improvement or slight reconfiguration; however, some require complete reconstruction or new measurement method. Boundary outflow and internal outflow sites are generally new sites, but their locations are defined at the crossing of the District boundary by the conveyance channel. These sites may require the modification of the site for flow measurement accuracy or installation of the measurement device. Drain water recovery sites are all historical drain recovery sites that need refurbishment or redesign, or addition of flow measurement.

Inventory of Existing Sites

Existing sites were identified through consultation with District operations staff and digitally inventoried in tabular form and in an interactive mapping format. For each site type, several sites were selected for

⁷ The RemoteTracker is a portable measurement device developed specifically as a water district delivery measurement solution in response to State of California Senate Bill x7-7. The device is currently being utilized by some Feather River water users.

field inspection to obtain dimensions, coordinates, photos and operational features typical of the site type to aid in strategy development and costing. For each site proposed for improvement, Table 11 provides the site name, the site type, latitude, longitude, and a description of the existing conditions. As previously discussed, the improvement process described here focuses on primary outflow and spill points and drain water recovery sites and may not include all minor features.

Table 11. Inventory of Existing Sites.

Site Name	Latitude	Longitude	Site Type	Description of Existing Conditions
Sutter Butte Main Canal Inflow	39.435	-121.678	Boundary Inflow	Existing SonTek acoustic Doppler flow meter installed downstream from Looney Weirs. Accuracy not verified.
Hamilton Drain	39.407	-121.716	Boundary Outflow	No measurement. Bridge abutments for W Biggs Gridley Road crossing create 16 ft wide section. Flow is channelized to approximately half of crossing width. Inflow points immediately upstream of crossing
Meyers Drain	39.420	-121.674	Boundary Inflow	Concrete headwall off of Sutter-Butte Main Canal with undershot outlet gates.
Meyers Drain	39.396	-121.716	Boundary Outflow	No measurement. Bridge abutments for W Biggs Gridley Road crossing create 8 ft wide section. Flow fills fill width with a HWL of ~2-feet. Meyers Drain and tailwater drain meet just upstream from crossing
Brooks Drain	39.408	-121.671	Boundary Inflow	Concrete headwall off of Sutter-Butte Main Canal with undershot outlet gates.
Brooks Drain	39.381	-121.716	Boundary Outflow	No measurement. Crossing at West Biggs Gridley Road is wide and shallow. Bridge abutments at Rudd Lane create 9.5-foot wide rectangular cross section. Cemetery confluence just d/s of Rudd Lane
Cemetery Drain	39.378	-121.707	Boundary Outflow	No measurement. Very deep channel between West Biggs Gridley Road and Brooks Drain. Flow is channelized under County Road crossing. Private bridge 300 feet u/s from Brooks confluence creates 10ft wide rectangular section. A 5ft diameter CMP 200ft u/s from confluence used as private crossing. Typical flow depth appears shallow in all cases.
Gridley Drain	39.358	-121.719	Boundary Outflow	No measurement. 6ft diameter RCP under Randolph Avenue approximately 0.5 miles upstream from BWD boundary. Culvert appears to have sedimentation issues
DD 1	39.311	-121.145	Boundary Outflow	No measurement. Siphon under Sutter-Butte Canal to drain channel that eventually empties to the Feather River. Large diesel powered pump provides drainage during times of high downstream flood waters
Snake River Inflow at Pennington Road	39.275	-121.753	Boundary Inflow	No measurement. 12ft wide single bay concrete weir structure upstream from County Road Crossing. Weir structure doesn't appear to be in use. Channel is approximately 8 feet deep.

Site Name	Latitude	Longitude	Site Type	Description of Existing Conditions
Snake River Outflow at SEWD Farrington Lateral	39.2068	-121.7061	Boundary Inflow	No existing measurement. Earthen channel with steep, heavily vegetated banks. A measurement site downstream from confluence with RD2056 drain will measure total inflow.
Lateral 4 Spill	39.312	-121.724	Internal Spill	No measurement. CMP weir box with 4' wide weir. HWM suggest approximately 1ft of drop across the weir boards. 20ft of 36" CMP provides drainage. Turnout immediately upstream.
West Chandon Spill	39.276	-121.725	Internal Spill	No measurement. Two bay concrete weir structure. 4ft wide x 3.5ft deep openings. One for spill one for continuation of lateral. 24" steel pipes convey water from structure to spill or lateral. Turnouts immediately upstream. Very little freeboard
Clark Road Spill	39.229	-121.706	Internal Spill	No measurement. 4ft wide weir structure with concrete headwall side spills from canal to adjacent drain channel. 18" CMP pipeline provides conveyance and free falls into drain. Pipe appears to be flow restriction
Chandon Spill	39.236	-121.706	Internal Spill	No measurement. 15" diameter sluice gate and concrete headwall. Downstream piping through embankment to adjacent drain ditch
Manuel Spill	39.260	-121.713	Internal Spill	No measurement. 3' CMP weir box upstream from crossing with 12' CMP piping to drain
Cox Spill	39.335	-121.634	Internal Spill	Existing automated overshot gate set to enable return flow of operational spills to the Feather River.
Township Spill North	39.301	-121.693	Internal Spill	No measurement. Elevated flume with side spill weir with adjustable crest height. 4' wide rectangular canal gates set so water spills over the top. Spills to RD 2056 and Morrison Slough. Four weir bays in Chandon Lateral maintain water level
Township Spill South	39.301	-121.693	Internal Spill	No measurement. Elevated flume with side spill weir with adjustable crest height. 4' wide rectangular canal gates set so water spills over the top. Spills to RD 2056 and Morrison Slough. Four weir bays in Chandon Lateral maintain water level
Boeger Flume Spill North	39.294	-121.719	Internal Spill	No measurement. 3ft wide wooden flashboard bay that spills from elevated flume to drain channel. Water level held by check structure 400-feet downstream. Manually controlled drain pump can pump from drain to lateral.
Boeger Flume Spill South	39.294	-121.719	Internal Spill	No measurement. 3ft wide wooden flashboard bay that spills from elevated flume to drain channel. Water level held by check structure 400-feet downstream. Manually controlled drain pump can pump from drain to lateral.
Lateral 3 Spill	39.38515	-121.68828	Internal Spill	No measurement. Two ~30" diameter siphons under Highway 99 exit in structure with delivery to north, delivery to south and 4ft flashboard bay to west

Site Name	Latitude	Longitude	Site Type	Description of Existing Conditions
Lateral 6 Spill	39.35066	-121.68178	Internal Spill	No measurement. 4' wide weir box upstream from Sheldon Road Crossing is regulated using boards. Spills travel through 12" RCP to East to DD1 drain
Lateral 7 Spill	39.3358	-121.70643	Internal Spill	No measurement. 3' wide concrete weir box with 12" steel pipe outlet. Trash screen at front. Not much drop, pipe may be restriction. Two deliveries immediately upstream. ~100ft of channel being converted to pipeline 700ft upstream from spill
Lateral 8 Outflow	39.369	-121.706	Boundary Outflow	No measurement. Open canal drops into 36" RCP pipe for 22' and then into open box with open flow propeller meter. Trash screen at heading of pipe. Continues in pipeline under W Biggs Gridley Road to BWGWD system
Schroader Well	39.294	-121.706	Internal Inflow	Magnetic meter currently installed on discharge piping. 300hp, 4,000 GPM, approximately 615ft well
Township Well	39.301	-121.687	Internal Inflow	No measurement. 250hp, 3,500 GPM, approximately 600ft well
Larkin Road Spill	39.25502	-121.6603	Internal Spill	No measurement. CMP weir box with 4' wide weir and concrete headwall. 50ft of 12" CMP provides drainage. Significant debris problem at this site
Hartman Spill	39.34484	-121.70643	Internal Spill	No measurement. 3ft wide weir box with concrete headwall and 24" diameter outlet pipe that empties to drain. Immediately upstream from 36" culvert in Lateral 7. approximately 0.5' of drop across weir
East Chandon Spill	39.26	-121.70564	Internal Spill	No measurement. 3' wide weir box and concrete headwall with 18" diameter outlet pipe that empties to drain. Turnout immediately upstream
Morris Spill	39.38089	-121.67869	Internal Spill	No measurement. 18' diameter culvert pipe at end of Morris Stub Lateral that drains to Cemetery. All upstream turnouts abandoned. No control on culvert. 24" sluice gate at split with Lateral 3 0.3 miles upstream

Boundary Outflow and Spill Measurement and Drain Water Recovery Physical and Operational Improvements

The two improvement packages include sites selected based on strategies described in the preceding paragraphs. For each site, improvement is split into two levels, Level 1 and Level 2. Level 1 improvements often are infrastructure and measurement enhancements that are manually operated or read, but designed as SCADA-Ready⁸ sites. These improvements include, but not limited to: VFD-controlled pumps, automated gates, measuring weirs, acoustic Doppler meters, propeller meters, and RemoteTracker devices. Level 2 improvements build on the Level 1 improvements by adding electronic sensors, installing on-site digital display of flow rate or other parameters, or add remote monitoring or

⁸ "SCADA-Ready" describes a package of hardware and/or software that communicates and operates locally but has been specifically designed and installed to readily accept a data transmission and receiving device (e.g. radio, cellular modem, etc.) and to provide remote communication with an established base station and SCADA human machine interface (HMI).

control through a Supervisory Control and Data Acquisition System (SCADA). Level 1 improvements are stand-alone, while Level 2 improvements generally require Level 1 to be completed prior or simultaneously. This phased implementation provides the District the flexibility to complete Level 1 (which has significant benefits on its own) while assessing the benefits of SCADA, prioritizing sites, establishing the SCADA base station and gradually implement the more complex or more expensive sites.

Although Level 2 is not universally required to be completed to obtain significant benefits, several sites will greatly benefit from it. For example, remotely located end spill sites or boundary outflow sites are not frequently visited by operators, and if they are visited and spill is noticed, it may not be worth the travel time to the heading to make a change. Remote monitoring would eliminate travel time, but does require the development of a SCADA office base station.

Additionally, in some cases, there is potentially some savings in capital costs by completing level 1 and level 2 at the same time.

Table 12 provides a description of the improvement proposed for each Boundary Flow and Primary Spill and Drain Recovery Sites. All costs are subject to revision following refinement of site improvements following more detailed review and design.

[This Page Intentionally Blank]

Table 12. Summary of Boundary Outflow and Primary Spill Measurement Improvement and Drain Water Recovery Sites.

Site Name	Site Type	Level 1 Modernization and Enhancement	Capital Cost (\$)	Annual Cost (\$/yr)	Level 2 Modernization and Enhancement	Capital Cost (\$)	Annual Cost (\$/yr)
Sutter/Butte Main Canal Inflow	Boundary Inflow	Construct concrete lined control section at location of existing meter. Perform velocity index calibration of existing meter and install walkway over sensor for verification purposes. Replace meters as necessary.	\$55,400	\$5,300	Upgrade and reinstall existing solar power site, flow display and communication hardware and integrate with SCADA system to allow remote monitoring of flow rate.	\$5,900	\$600
Hamilton Drain	Boundary Outflow	Construct control section upstream of W. Biggs Gridley Road and install ADVM.	\$26,400	\$2,900		\$5,900	\$600
Meyers Drain	Boundary Inflow	Install weir box on downstream end of existing pipe and install open channel propeller meter. Install trash rack at inlet. Replace heading gate as necessary to provide adjustable and reliable control. Site will be SCADA-Ready.	\$26,400	\$2,400		\$11,800	\$1,200
Meyers Drain	Boundary Outflow	Install ADVM in existing control section created by bridge abutments	\$26,400	\$2,400		\$11,800	\$1,200
Brooks Drain	Boundary Inflow	Install weir box on downstream end of existing pipe and install open channel propeller meter. Install trash rack at inlet. Replace heading gate as necessary to provide adjustable and reliable control. Site will be SCADA-Ready.	\$26,400	\$2,400		\$11,800	\$1,200
Brooks Drain	Boundary Outflow	Install ADVM in existing control section created by Rudd Ave bridge abutments	\$26,400	\$2,400	Add communication hardware to measurement site and integrate with SCADA system to provide real-time monitoring of flow rate and water level.	\$11,800	\$1,200
Cemetery Drain	Boundary Outflow	Construct sharp crested weir upstream from private bridge and install water level sensor	\$9,600	\$700		\$15,400	\$1,500
Gridley Drain	Boundary Outflow	Install ADVM in pipeline. Determine if sediment is problem during irrigation season or not	\$26,400	\$2,900		\$5,900	\$600
DD 1	Boundary Outflow	Install downward looking ultrasonic sensor at crossing downstream from Sutter-Butte Canal Siphon. Construct control section if needed	\$26,400	\$2,900		\$5,900	\$600
Snake River Inflow at Pennington Road	Boundary Inflow	Remove existing weir and construct BCW with level sensor	\$9,600	\$700		\$15,400	\$1,500
Snake River Outflow at SEWD Farrington Lateral	Boundary Inflow	Install ADVM in cross section formed by Farrington flume abutments. Perform velocity index calibration of measurement site and install solar power system, digital flow display and related components. Site will be SCADA-Ready.	\$26,400	\$2,900	Add communication hardware to measurement site and integrate with SCADA system to provide real-time monitoring of flow rate.	\$5,900	\$600
Lateral 4 Spill	Internal Spill	Replace weir box with new. Install sharp crested weir plate and mount custom staff gage calibrated to report spill flow rate based on the depth of water above the weir crest.	\$8,700	\$700	Install pressure transducer in new stilling well upstream of spill box to measure head on weir. Perform calibration of weir. Install communication hardware and integrate with SCADA system to allow remote monitoring.	\$15,400	\$1,500
West Chandon Spill	Internal Spill	Replace weir box with new. Install sharp crested weir plate and mount custom staff gage calibrated to report spill flow rate based on the depth of water above the weir crest.	\$8,700	\$700	Install pressure transducer in new stilling well upstream of spill box to measure head on weir. Perform calibration of weir. Install communication hardware and integrate with SCADA system to allow remote monitoring.	\$15,400	\$1,500
Clark Road Spill	Internal Spill	Remove existing concrete weir box and CMP. Install longer overpour weir with fixed crest, install drain gate and larger discharge piping to ensure free flow over weir. Install pressure transducer in new stilling well upstream of spill box to measure head on weir. Perform calibration of weir. Install communication hardware and integrate with SCADA system to allow remote monitoring.	\$8,700	\$700	Add communication hardware to measurement site and integrate with SCADA system to provide real-time monitoring of flow rate and water level.	\$15,400	\$1,500

Site Name	Site Type	Level 1 Modernization and Enhancement	Capital Cost (\$)	Annual Cost (\$/yr)	Level 2 Modernization and Enhancement	Capital Cost (\$)	Annual Cost (\$/yr)
Chandon Spill	Internal Spill	Install trash screen upstream and install weir box at downstream end of discharge pipe and install propeller meter	\$26,400	\$2,400		\$11,800	\$1,200
Manuel Spill	Internal Spill	Replace weir box with new. Install sharp crested weir plate and mount custom staff gage calibrated to report spill flow rate based on the depth of water above the weir crest.	\$8,700	\$700	Install pressure transducer in new stilling well upstream of spill box to measure head on weir. Perform calibration of weir. Install communication hardware and integrate with SCADA system to allow remote monitoring.	\$15,400	\$1,500
Cox Spill	Internal Spill	Add communication hardware to measurement site and integrate with SCADA system to provide real-time monitoring of flow rate and water level.	\$11,800	\$1,200	None	\$0	\$0
Township Spill North	Internal Spill	Replace adjustable crest gate with flap gate for emergency spill only	\$8,500	\$0		\$0	\$0
Township Spill South	Internal Spill	Remove existing gate and add boards to slots. Cut-down existing wall to create 40' long weir. Install level sensor	\$6,500	\$356		\$0	\$0
Boeger Flume Spill North	Internal Spill	Install fixed crest weir and level sensor	\$8,700	\$700		\$15,400	\$1,500
Boeger Flume Spill South	Internal Spill	Install propeller meter on drain pump inflow. Install fixed crest weir and level sensor	\$19,100	\$1,700		\$11,800	\$1,200
Lateral 3 Spill	Internal Spill	Install trash rack upstream of siphon. Install fixed crest weir and level sensor.	\$8,700	\$700		\$15,400	\$1,500
Lateral 6 Spill	Internal Spill	Replace trash screen upstream and install weir box at downstream end of discharge pipe and install propeller meter	\$26,400	\$2,400		\$11,800	\$1,200
Lateral 7 Spill	Internal Spill	Replace existing pipeline with larger diameter (15") HDPE pipe. Install fixed crest weir and level sensor	\$8,700	\$700	Add communication hardware to measurement site and integrate with SCADA system to provide real-time monitoring of flow rate and water level.	\$15,400	\$1,500
Lateral 8 Outflow	Boundary Outflow	Perform validation of propeller meter reading	\$4,000	\$219		\$11,800	\$1,200
Schroeder Well	Internal Inflow	None	\$0	\$0		\$0	\$0
Township Well	Internal Inflow	Add magnetic meter	\$9,000	\$493		\$11,800	\$1,200
Larkin Road Spill	Internal Spill	Replace structure and pipe with new inlet (with trash screen) and outlet weir boxes and HDPE pipe. Install propeller meter in downstream end	\$26,400	\$2,400		\$11,800	\$1,200
East Chandon Spill	Internal Spill	Install weir box on discharge end and install propeller meter. Install trash screen on upstream side	\$26,400	\$2,400		\$11,800	\$1,200
Morris Spill	Internal Spill	Cut-down top of headwall at Stubbs heading. Install board guides and add fixed crest. Install level sensor. Retain sluice gate, remove discharge pipe.	\$8,700	\$700		\$15,400	\$1,500
Chandon Drain Pump	Drain Water Recovery (Pump)	Install flow meter on pump discharge piping to enable improved manual control.	\$6,500	\$356	Add communication hardware to measurement site and integrate with SCADA system to provide real-time monitoring of flow rate.	\$11,800	\$1,200
Boeger Drain Pump	Drain Water Recovery (Pump)	Rebuild pump as necessary. Install flow meter on pump discharge piping to improve manual control.	\$6,500	\$356		\$11,800	\$1,200

Project Costs

Costs for the Boundary Outflow and Primary Spill Measurement Project

Reconnaissance level cost estimates were prepared for both improvement packages described in the preceding sections as a basis for prioritization and funding of site improvements. For the Boundary Flow and Primary Spill Measurement package, the total combined cost (Level 1 and Level 2) of improvement is approximately \$821,000, with estimated annualized costs of \$78,000. Total costs are further summarized in Table 14.

Table 14. Summary of Costs.

<u>Boundary Flow and Primary Spill Measurement</u>	<u>Level 1</u>		<u>Level 2</u>	
	<u>Capital Costs (\$)</u>	<u>Annual Costs (\$)</u>	<u>Capital Costs (\$)</u>	<u>Annual Costs (\$)</u>
Boundary Flows Subtotal	\$294,800	\$29,393	\$107,500	\$10,800
Spills Subtotal	\$225,100	\$18,675	\$194,000	\$19,200
Total Cost =	\$519,900	\$48,068	\$301,500	\$30,000

Costs for the Drain Water Recovery Project

The total cost of improving or developing the 2 drain recovery sites is \$37,000 with an estimated annualized cost of \$3,000. Total costs are further summarized in Table 15.

Table 15. Summary of Costs.

<u>Drain Water Recovery</u>	<u>Level 1</u>		<u>Level 2</u>	
	<u>Capital Costs (\$)</u>	<u>Annual Costs (\$)</u>	<u>Capital Costs (\$)</u>	<u>Annual Costs (\$)</u>
Total Cost (2 Sites) =	\$ 13,000	\$ 712	\$ 23,600	\$ 2,400

The aforementioned costs do not include a SCADA base station (which would be required for Phase II) or any mobile operator terminals that would form the backbone of the District SCADA system, or any costs of spare equipment to be kept on hand to repair or replace individual site components due to theft, vandalism, or other failure. These costs are summarized in Table 16. This cost represents a robust SCADA network that would be capable of monitoring the identified measurement and drain recovery sites as well as existing or future sites, such as detailed in the Modernization program. The cost of the office base station may be drastically reduced, or eliminated, if the District is able to 'piggy-back' on to and expand the existing SCADA network owned and operated by the Joint Water Districts and Joint Board.

Table 16. Summary of Costs for SCADA Office Base Station and Spare Parts.

<u>Item</u>	<u>Capital Cost (\$)</u>	<u>Annual Cost (\$)</u>
SCADA Office Base Station	\$138,063	\$17,039
Spare Parts	\$23,692	\$2,913

Potential Benefits

Boundary Flow and Primary Spill Measurement and Drainwater Recovery

Flow paths targeted under the boundary flow and primary spill measurement and drainwater recovery projects are:

- Operational spillage
- Tailwater
- Drainage Outflows
- Diversions

Measurement of boundary flows and spills provides operators the tools to reduce operational losses. Reduction in losses may result in decreased required diversions. Reuse of operational spillage and tailwater results in decreased required diversions. Because BWD water users rely on drainwater in many cases, improvements would increase the functionality of these sites, but not necessarily result in additional conserved water.

Available water not diverted remains in storage and could potentially be available to meet local, regional, or statewide water management objectives. Through implementation of these projects, it is estimated that approximately 5 to 15 percent⁹ of existing boundary outflows during the irrigation season could be conserved annually, or between approximately 3,500 and 10,500 af per year depending on the level of implementation.

Net Benefit Analysis

The district is currently implementing associated EWMPs at locally cost-effective levels. BWD has not used its full allocation in recent years, and thus would not achieve cost savings through additional conservation. The estimated implementation cost per unit of water conserved ranges from approximately \$10 to \$29 per acre-foot. As a result, further implementation of the boundary outflow and primary spill measurement and drainwater recovery project is not locally cost effective at this time. In the future, it is anticipated that the costs and estimated benefits of this improvement project will be evaluated as additional information becomes available.

⁹ Based in part on percent reductions in spillage for various improvement measured listed in the technical memorandum "Spillage Reduction- Monitoring and Verification" published by the Agricultural Water Management Council, and partly on experience with local conditions and judgment.

Project 3: Removal of Sutter-Butte Canal Bottlenecks

Project Description

The Sutter-Butte Canal upstream of the Sunset Pumps has two structures that limit capacity: the Looney Weir and the Rio Benito Road Bridge. The objectives of this project are to reconstruct these two sites with increased capacity structures to prevent them being a limitation to meeting downstream demand. Additionally, the Rio Benito Road Bridge has been identified as potentially being structurally inadequate and is scheduled to be replaced by the County at a future, unidentified date.

The Looney Weir is located in the Sutter-Butte Canal approximately 2 miles downstream from Thermalito Afterbay. The current capacity of the two AMIL gates is estimated at 900 cfs, but the installation of a parallel bypass gate pipe increases the structures capacity to approximately 960 cfs. Required capacity at this point to meet demand is approximately 1,000 cfs. The Rio Benito Bridge is located approximately 0.5 miles downstream from the Looney Weir. The bridge consists of concrete abutments and several concrete pile piers at the canal midsection, parallel to the flow. The location of the abutments decreases the width of the channel and limits capacity.

For each site to be improved, conceptual designs developed as part of the Sutter Butte Regional Conveyance Study¹⁰ were reevaluated to ensure consistency with the objectives and costs were updated to reflect normal inflation of construction costs and to account for prevailing wage rates likely to be required if grant funding was secured for implementation. Approximately five additional bottlenecks were identified along the Sutter-Butte Canal, but these are within the boundaries of SEWD and are discussed in a separate attachment.

Inventory of Existing Sites

Existing sites were identified through consultation with district operations staff. Each site was visually inspected to obtain coordinates, photos and operational features to aid in strategy development and evaluation of improvement costs.

Physical and Operational Improvements

Table 17 provides a description of the existing site condition and the improvement proposed for each of the two bottleneck removal sites. All costs are subject to revision following refinement of site improvements following more detailed review and design.

¹⁰ GEI Consultants, 2006. Regional Conveyance System Improvement Project – Final Report, May 2006. Completed for Sutter Extension Water District by Bookman-Edmonston, a division of GEI Consultants, Inc.

Table 17. Summary of Improvements for Bottleneck Removal.

Site Name	Latitude	Longitude	Description of Existing Conditions	Description of Operational Objective with Improvements	Description of Proposed Improvement	Capital Cost (\$)	Annual Cost (\$/yr)
Looney Gates	39.436	-121.678	Two ~16ft wide AMIL gates installed in concrete structure. Approximate capacity is 900cfs.	Increase capacity of structure to 1000cfs+ to meet the downstream demands.	See Joint Board Improvement Description. Remove existing AMIL gates and construct new structure with minimum capacity of 1,000 cfs.	\$493,947	\$27,057
Rio Benito Bridge	39.428	-121.678	Concrete abutments with wing walls. Center pier consists of four round piles parallel to flow. Abutments create narrow spot in canal.	Remove flow restriction and increase capacity of section to the same as adjacent Main Canal sections	Demolish existing bridge, bridge abutments, and center pier and replace the structure with a wider, sturdier structure. Reconstruct canal in immediate vicinity to remove flow restriction.	\$375,273	\$20,556

Project Costs

Reconnaissance level cost estimates were prepared for both improvement projects described in the preceding sections as a basis for prioritization and funding of site improvements. The total combined cost of removing and replacing the bottlenecks is approximately \$869,000, with estimated annualized costs of \$48,000. Individual site costs are summarized in Table 18.

Table 18. Summary of Costs.

<u>Bottleneck Removal</u>	<u>Capital Costs (\$)</u>	<u>Annual Costs (\$)</u>
Looney Weir	\$493,947	\$27,057
Rio Benito Road Bridge	\$375,273	\$20,556
Total Cost =	\$869,221	\$47,613

Potential Benefits

The removal of the two identified bottlenecks have no quantifiable water conservation benefits; however, other benefits for BWD may include:

- Increased capacity to meet downstream irrigation demand (limited to downstream canal capacity constraints) may enable increased rotational frequency or larger available irrigation heads. This may increase irrigation efficiency.
- Reduced reliance on Sunset Pumps by SEWD. May incentivize joint projects between BWD and SEWD.
- Increased ability to meet refuge and other water user demands (limited to downstream canal capacity constraints).
- Potential for avoided labor required to make frequent gate adjustments.
- Increased safety and structural adequacy of structures.

Additional flow capacity at the heading could reduce the reliance of SEWD on the Sunset Pumps and decreasing annual pumping costs. The benefits of this can be estimated by assuming that pumping could be offset by approximately 100 cfs during periods when demand exceeds current capacity (typically only in May of each year during the peak rice flood-up period). It is estimated that the Sunset Pumps require approximately 43 kilowatt-hours of electricity to pump one af of water¹¹, so a continuous offset of 100 cfs for the month of May corresponds to an approximate savings of \$40,000 at an electrical rate of \$0.15 per kWh. The monetary benefit to SEWD may incentivize cost-sharing on mutually beneficial projects elsewhere on the Main Canal.

¹¹ Referenced from Table 1. Sunset Pumps pump test information (Durham Pumps, Fall 2003) in the Rapid Appraisal Report prepared for Sutter Extension Water District by the Irrigation Training and Research Center, June 2007.

Net Benefit Analysis

A net benefit analysis was not performed for this project because the improvements are not categorized as an EWMP. Increased water supply for Sutter National Wildlife Refuge has been evaluated as part of the Sutter Butte Regional Conveyance Study¹².

¹² GEI Consultants, 2006. Regional Conveyance System Improvement Project – Final Report, May 2006. Completed for Sutter Extension Water District by Bookman-Edmonston, a division of GEI Consultants, Inc.

Project 4: Alternatives for Improving Delivery Service to Pressurized Irrigation Systems

Project Description

Butte Water District is a unique district when compared to the primary Feather River water users because, unlike Western Canal Water District, Richvale Irrigation District, and Biggs West Gridley Water District, only approximately 48 percent is occupied by crops in which level basin or flood irrigation is best suited (rice and pasture). The remaining 52 percent are permanent crops or other miscellaneous crops. Because of this high percentage of permanent crops, many growers in BWD are converting to pressurized micro irrigation systems (e.g. drip, micro sprinklers) to take advantage of various agronomic, labor, water conservation, and economic benefits. These irrigation methods typically require a small flow rate for a long duration and at a high frequency which is inconsistent with the irrigation scheduling and methods that were historically used for these crop types. Providing this level of flexibility is difficult and puts additional strain on the system and its operators. In some cases, this has adversely affected service and has caused an increasing number of growers to switch from surface water to groundwater which can be more flexible and typically requires less filtration than District supplied water. The use of District water typically requires two types of filtration for micro irrigation systems: a coarse filter to remove large debris, and a fine filter to remove smaller particles. The filters must be routinely flushed to remove debris, requiring additional water and requiring infrastructure to collect or convey debris.

In general, the objective of this improvement project is to identify opportunities to provide flexible deliveries at a frequency, rate and duration that will incentivize growers to utilize surface water over groundwater.

The delivery service required by pressurized irrigation is very similar to the maintenance flows that the District must provide to rice fields during the majority of the growing season. Therefore, it is anticipated that laterals that serve both rice and permanent crops are suited to meet the frequency, rate and duration requirements, but likely fall short in filtration and water quality. Canals that serve primarily permanent crops are subjected to common difficulties with providing flexible service to pumped deliveries, as listed below:

1. Long durations and small flow rates require supply canals to remain filled for a longer period when compared to a rotational system. This increases losses and requires a small maintenance flow which is difficult if canal control is limited.
2. High frequency, long duration and small flow rate deliveries inevitably lead to many simultaneous deliveries that require a large portion of the system (if not all) to be filled throughout the irrigation season.
3. Pumped deliveries require a constant supply to prevent pump damage. This is nearly impossible to supply in an open canal system without storage or supplying extra water to the lateral to ensure the pump doesn't run dry. The latter typically leads to spillage.
4. Power failures, mechanical failures or other unannounced shutoffs cause fluctuations in water levels requiring intensely vigilant operators or result in spillage.
5. Water ordering is difficult in an open system with pump deliveries because uncertainties in rotation, duration, demand rate, etc. are high. This often leads to excess water being ordered and spilled if not used.

Based on a field tour of BWD, observation of irrigation systems, field layouts, delivery gates, and conveyance infrastructure, several improvement alternatives were identified that have the potential to improve service to pressurized irrigators. These are listed below in no particular order:

1. Construct regulating storage within in the system to enable flexible service while minimizing spillage.
2. Construct intertie pipelines between adjacent laterals to increase the downstream demand area available for use of spill or excess water supplied to prevent pump damage.
3. Convert laterals with concentrated pressurized irrigation to buried, mechanically pressurized supply pipeline and delivery network.
4. Construct group turnouts in areas with high concentration of pump deliveries to minimize labor requirements.
5. Construct on-channel pumping sumps to accommodate on-farm pressurized irrigation systems and minimize filtration requirements.
6. Install manual filtration screens (coarse filtration) at the heading of each lateral.
7. Install manual filtration screens (semi coarse filtration) at each pressurized turnout.
8. Install automated filtration screens (semi fine filtration) at the heading of each lateral.
9. Install automated filtration screens (semi fine to fine filtration) at each pressurized turnout.
10. Develop construction and technical standards for growers interested in connecting to the District system. This will standardize turnouts and provide the opportunity to add flow measurement and possibly remote monitoring to each pump to provide operators with real-time information on pump status and pumping requirement.

Although alternatives 1 and 2 above are conventional methods for increasing flexibility (among other benefits), a high level review did not identify any sites in BWD with anticipated benefits significant enough to justify further analysis. The remaining alternatives can be generally packaged into three categories: Conversion to Pressurized Laterals, Improvement of Turnout Configurations, and Debris Management. The physical or operational components associated with each of these categories, or packages, are described in additional detail in subsequent sections.

Physical and Operational Improvements

Conversion to Pressurized Laterals

In general concept, conversion of an open channel delivery system to a closed, pressurized delivery network is complicated and requires extensive analysis to quantify all associated costs and benefits. For purposes of this analysis, several simplifying assumptions were made to provide a generalized, high-level estimate of probable costs to assist in prioritization of improvements and consideration for more detailed, feasibility-level designs.

Conversion to pressurized laterals is generally only considered at a conceptual level if a lateral can be identified with a high concentration of permanent crops and existing infrastructure cannot provide the required service level. For BWD, the Live Oak Lateral and the Webster Laterals serve an estimated 950 acres of primarily permanent crops on the southeastern edge of the district boundary making it a likely candidate for consideration. A conceptual design of a pressurized delivery network was developed by making the following assumptions:

1. Demand estimated at 8 GPM/acre and increasing to 10 GPM/acre in the downstream-most pipe segments to provide a similar level of service as those at the upstream end.
2. The minimum turnout pressure supplied by the network would be 30 psi to be compatible with most micro irrigation systems.
3. Electric motors and centrifugal pumps would pump from the Sutter-Butte Canal to supply the pipeline. No reservoir would be required.
4. Turnouts would be spaced at intervals of 450 ft along the laterals to provide the pressurized service to growers.
5. Ground surface elevations from head to tail, and total lengths of existing conveyances estimated using Google Earth.

Based on the listed assumptions, the design outputs for the conceptual design are summarized in Table 19.

Table 19. Summary of Design of Pressurized Laterals.

Total Pipeline Length, LF	19,000
Minimum Pipe Size, inches	10
Maximum Pipe Size, inches	30
Maximum Flow Rate, GPM	8,205
Minimum Supplied Pressure, PSI	30
Estimated TDH, FT	95.3
Estimated Total HP required	222

The pressurized lateral conceptual design included fully adjustable pressurized turnouts fitted with inline flow meters and pressure gages, all air/vacuum vents, pressure relief valves, isolation valves, fittings and other miscellaneous appurtenances required for a fully operational supply network. The pump station would include a pumping sump, pump stands, electrical power, variable frequency control, primary flow measurement, discharge manifold, and all related site features.

Improved Turnout Configuration

The improved turnout configuration package includes two alternatives for improved infrastructure, and a the description of a standardization process that could be implemented by the District to facilitate adoption of formal rules regarding the supply of on-farm pressurized irrigation systems, and enable some enforcement and control over the connection details which, in the end, will likely enable enhanced delivery service.

A conceptual design for improved turnout specifically for on-farm pressurized irrigation systems would include a rectangular concrete structure with one open side integrated into the side of a supply canal such that the pump intake is located out of the channel (minimizing canal flow restriction), but has an ample supply of water (assuming the canal stays full), and any debris can be manually or automatically cleaned from the intake screen and swept downstream. This alternative simplifies District operational effort and provides increased flexibility and cost savings potential (due to reduced filtration requirements) for the grower.

The construction of group turnouts along laterals with high concentration of on-farm pressurized systems would require the reconfiguration of certain reaches of canal into essentially level-top pools.

This provides limited storage in the vicinity of turnouts, reduces the effects of upstream or downstream fluctuations and maintains a constant water level for more efficient pumping. Additionally, one level-top pool is generally simpler to operate than several individual turnout locations.

Debris Management

Screening debris at strategic locations in the District laterals would provide several advantages to overall operations and to system efficiency. Although cleaning screens throughout the season would potentially require additional staff time, significant time, effort, and expenses could be saved by preventing canal overtopping, structures washing out, and expensive canal cleaning operations while providing improved service to customers. Specific sites have not been identified for BWD, but likely locations are the head of primary laterals and at the upstream ends of siphons or road crossing. Optimally, screens would be located and positioned so that it prevent debris from entering the channel, but allows the sweeping velocity to pass the debris downstream.

Simple bar screens with manual cleaning are likely the most cost effective and justifiable option for the majority of locations in the system; however, a mechanical chain screen that is self-cleaning may be preferable for areas with high debris load or sensitive pump intakes. A screen that physically extracts the debris is advisable at sites where there is no sweeping flow that could move debris downstream (e.g. at a dead end lateral). For turnout filtration, sloping punch plate screens provide semi-fine filtration and have a smooth surface that allows debris to more easily be swept downstream. Automatic turnout screens that mount to the pump intake piping provide fine filtration and are self-cleaning typically using a combination of a rotating screen and a water nozzle.

The installation of manual trash screens requires regular (i.e. daily) inspection by the operator and the removal of accumulated trash as necessary. This could likely be incorporated into daily operations. Screens would be designed with bars sloping downstream so the velocity of the passing water pushes floating debris to the upper portions of the screen (above the water surface) thereby minimizing flow restrictions. This also makes them easier to clean.

In addition to the three improvement categories described above, the replacement of heading structures, water level control structures, and spill structures would improve operations, enabling steadier deliveries, more rapid passage of flow fluctuations to meet demands, and monitoring to inform changes and notification of issues (though SCADA implementation). These outcomes would likely increase the level of service provide to pressurized deliveries. The System Modernization Program provides additional descriptive information, site specific improvements, and related costs.

Project Costs

Reconnaissance level cost estimates were prepared for each of the three improvement categories and the alternatives in each. The costs (Table 20) serve as a basis for prioritization and funding of site improvements. Individual projects costs are provide as unit values in some cases to enable costs to be estimated for sites with varying requirements. Annual costs for the conversion to pressurized laterals include estimations of required energy costs.

Table 20. Summary of Costs.

Improvement	Estimated Total Cost (\$)	Annual Costs (\$)	Unit
Conversion to Pressurized Laterals			
Conceptual Cost Estimate for Sunset and Webster Lateral =	\$2,415,500	\$333,212	LS
Cost per Acre =	\$2,500		\$/AC
Cost per linear foot of pipe =	\$200		\$/LF
Cost per CFS =	\$132,200		\$/CFS
Improved Turnout Configuration			
Development of Standardized Turnout Design and Technical Specifications =	\$5,000	\$274	LS
Design and Construction of On-Channel Pump Sump (includes self-cleaning screen) =	\$13,600	\$745	LS
Debris Management			
Sloped Vertical Bar Screen =	\$45		per SF
Automatic Rotating Chain Screen =	\$1,100		per SF
Sloped Punch Plate Screen =	\$30		per SF
Self-Cleaning Intake Screen (12" diameter) =	\$4,000		EA

Potential Benefits

The primary quantifiable benefit to the District with this improvement project is retaining surface water customers to sustain the groundwater system while maintaining reliable revenue from water sales that covers operations and maintenance costs. BWD is active in the management of the local groundwater basin and recognizes the benefits of conjunctive use of available water supplies and encourages the use of surface water to maintain net positive recharge of the aquifer.

Lateral pressurization offers additional unique benefits, including:

- Potential for improved air quality due to centralized pumping and reduction of potentially inefficient on-farm units.
- Potential for water conservation due to the incentive to convert to more efficient irrigation methods.
- Potential for increased crop yields to improved water management.
- Potential reductions in on-farm operations costs associated with irrigation, filtration, and power costs.

Net Benefit Analysis

A net benefit analysis was not performed for this project because the District is already implementing this EWMP at a locally cost-effective level. In the future, it is anticipated that the costs and estimated benefits of this improvement project will be evaluated as additional information becomes available.

[This Page Intentionally Blank]

Appendix 7-C
Feather River Regional Agricultural Water Management
Plan, 2014: Sutter Extension Water District Potential
Projects to Enhance Water Management Capabilities

This page intentionally left blank.

Feather River Regional Agricultural Water Management Plan

Volume II: Supplier Plan Components

August 2014



Prepared by

Northern California Water Association and
the Feather River Water Suppliers



6. Sutter Extension Water District

This section of the Feather River Regional AWMP contains plan components specific to Sutter Extension Water District (SEWD).

6.1 Contents

Contents

6.	Sutter Extension Water District.....	6-1
6.1	Contents	6-1
6.2	Introduction.....	6-3
6.3	Cross-Reference to Requirements of SBx7-7.....	6-5
6.4	Plan Preparation and Adoption.....	6-9
6.4.1	Regulatory Compliance	6-9
6.4.2	Public Participation and Adoption	6-9
6.4.3	Regional Coordination.....	6-9
6.5	Background and Description of Service Area.....	6-10
6.5.1	History and Organization	6-10
6.5.2	Size and Location of Service Area	6-12
6.5.3	Distribution and Drainage System	6-12
6.5.4	Terrain and Soils.....	6-19
6.5.5	Climate	6-22
6.5.6	Operating Rules and Regulations.....	6-23
6.5.7	Water Delivery Measurement and Calculation	6-23
6.5.8	Water Rate Schedules and Billing.....	6-23
6.5.9	Water Shortage Allocation Policies and Contingency Plan	6-24
6.5.10	Policies Addressing Wasteful Use of Water	6-25
6.6	Inventory of Water Supplies.....	6-25
6.6.1	Introduction.....	6-25
6.6.2	Surface Water Supply.....	6-25
6.6.3	Groundwater Supply	6-26
6.6.4	Other Water Supplies.....	6-27
6.6.5	Water Quality Monitoring Practices	6-27
6.7	Water Balance.....	6-28
6.7.1	Overview	6-28
6.7.2	Analytical Approach	6-28
6.7.3	Water Use.....	6-35
6.7.4	Drainage	6-44
6.7.5	Water Accounting (Summary of Water Balance Results).....	6-46
6.8	Climate Change.....	6-55
6.9	Efficient Water Management Practices and Water Use Efficiency.....	6-56
6.9.1	Efficient Water Management Practices	6-56

6.9.2	Evaluation of Water Use Efficiency Improvements.....	6-63
6.10	Attachments	6-73
6.10.1	Public Coordination and Adoption.....	6-75
6.10.2	Rules and Regulations	6-77
6.10.3	Potential Projects to Enhance Water Management Capabilities.....	6-85

Tables

Table 6.1.	Cross-Reference of Relevant Sections of the California Water Code to SEWD 2014 AWMP.	6-5
Table 6.2.	Characteristics of Dominant Soils.....	6-20
Table 6.3.	Mean Daily Weather Parameters by Month at Durham CIMIS Station (October 1984 to September 2012).....	6-23
Table 6.4.	Water Balance Flow Paths, Supporting Data, and Estimated Uncertainty.	6-33
Table 6.5.	Crop and Idle Acres, 1999-2012.....	6-35
Table 6.6.	Average Acreages and Annual Evapotranspiration Rates by Crop.....	6-39
Table 6.7.	Estimated Winter Diversions and Applied Water for Managed Wetlands and Rice Straw Decomposition.....	6-40
Table 6.8.	Total Groundwater Recharge, 1999-2012.	6-41
Table 6.9.	Net Groundwater Recharge, 1999-2012.....	6-43
Table 6.10.	Crop Idling Water Transfer Volumes, 1999-2012.....	6-43
Table 6.11.	Estimated Surface Outflow Volumes, 1999-2012.	6-44
Table 6.12.	Estimated Tailwater Volumes, 1999-2012.	6-45
Table 6.13.	Distribution and Drainage System Annual Water Balance Results, 1999-2012.....	6-51
Table 6.14.	Farmed Lands Annual Water Balance Results, 1999-2012.....	6-51
Table 6.15.	EWMP Implementation Status.	6-59
Table 6.16.	Summary of Targeted Flow Paths, Impacts, and Consequential Effects Associated with EWMP Implementation.....	6-65
Table 6.17.	WUE Improvement Categories.....	6-69
Table 6.18.	Applicability of EWMPs to WUE Improvement Categories.	6-71
Table 6.19.	Evaluation of Relative Magnitude of Past and Future WUE Improvements by EWMP.	6-72

Figures

Figure 6.1.	Organizational Chart.	6-12
Figure 6.2.	Boundary Flows and Irrigation and Drainage Facilities.....	6-17
Figure 6.3.	Water Balance Structure.....	6-29
Figure 6.4.	Crop and Idle Acres, 1999-2012.....	6-36
Figure 6.5.	March to September 2009 SEBAL Actual ET.....	6-37
Figure 6.6.	Average Monthly Consumptive Use of Water.	6-38
Figure 6.7.	Conceptualization of Shallow Groundwater Interception in Rice Growing Areas.....	6-42
Figure 6.8.	District Water Balance 1999-2012.....	6-47
Figure 6.9.	Average Monthly Inflows, 1999-2012.	6-48
Figure 6.10.	Average Monthly Outflows, 1999-2012.....	6-49



6.10.3 Potential Projects to Enhance Water Management Capabilities

A description of potential projects to enhance SEWD water management capabilities is provided on the following pages.



[This Page Intentionally Blank]

Attachment 6.10.3: Potential Projects to Enhance SEWD Water Management Capabilities

Overview

A total of four improvement projects with the potential to enhance water management by Sutter Extension Water District (SEWD) were evaluated. These range from comprehensive system modernization to localized projects related to boundary outflow and safety spill measurement, tailwater recovery, and removal of bottlenecks from the Main Canal. For each project, reconnaissance level implementation costs have been estimated. It is anticipated that these projects will be implemented over time, subject to the availability of funding and project prioritization. Potential improvements are assembled into the following project categories:

1. System Modernization
2. Boundary Outflow, Primary Spill Measurement, and Tailwater Recovery
3. Removal of Bottlenecks in the Sutter-Butte Main Canal
4. Alternatives for Improving Delivery Service to Pressurized Irrigation Systems

Summary of Cost Estimation Procedure

Reconnaissance level cost estimates were prepared for each project as a basis for prioritization and funding of site improvements. The following summary of the cost estimation procedure applies to all projects described in this attachment.

Site inventories were completed with the help of district staff, and several sites were visited to provide sufficient information to develop conceptual designs and to estimate material and labor quantities; however, all sites were not surveyed in detail. A general observation from the field visits was that many of the sites in a specific category (e.g. water level control) were similar in design and only varied in capacity. For this reason, conceptual designs were developed for each site type in several configurations and in a range of capacities as appropriate. The typical conceptual designs are listed in Table 1. Costs for these typical designs were developed based on estimates of required site components, quantities, and unit costs.

Table 1. Typical conceptual designs and the variations/configurations developed for purposes of cost estimation.

	Typical Design	Variations/Configurations
A	Acoustic Doppler velocimeter in lined section of channel	
B	Acoustic Doppler velocimeter in unlined section of channel	I. High capacity canal II. Mid-range capacity canal
C	New Precast Spill Box with 36" propeller meter at d/s end	I. 4 ft weir box II. 6 ft weir box
D	Precast headwall with new 36" undershot gate, piping and propeller meter at d/s end	
E	New Precast Spill Box with fixed, sharp-crest weir plate	I. 4 ft weir box II. 6 ft weir box
F	New precast spill box with piping and RemoteTracker bracket at d/s end. RemoteTracker not included.	
G	Locally automated combination weir	450, 250, 150, 75, 50, and 25 cfs capacity
H	Manually Adjusted Undershot Gates	Cost estimated on a per square foot of gate area basis
I	Automated Flow Control Gates	Cost estimated on a per square foot of gate area basis
J	SCADA hardware and related communication components	I. No add'l power source II. No add'l power source, w/ PLC III. W/ solar power system and PLC IV. W/ solar power system, pressure transducer and related components

Unit Costs

Unit costs for the various work items and materials were compiled from a variety of sources including published values, local suppliers, contractors and installers, and works previously completed by Davids Engineering or others. Standard unit prices were increased by 10% assuming prevailing labor rates will apply. Costs include material and equipment costs, installation labor, shipping, and tax (where applicable).

Cost types fall into three categories: Direct Costs, Indirect Costs, and Contingencies. Direct costs are associated with physical site improvements, while indirect costs represent other project costs such as engineering and design, environmental permitting, construction management, administration and legal, and overhead and are included as a percentage of the sum of extended costs plus the contingency. Contingency is applied to the subtotal of direct costs based on uncertainties present at this level of design and cost estimation and to account for unforeseen requirements. Total indirect costs plus contingency varied by site type to account for differences in site complexities, construction effort, engineering and design requirements, the source of the unit cost information, and professional judgment. Mark-ups are summarized in Table 2.

All projects were assumed to be designed and constructed using competitive bidding processes. It is likely that several of the site improvements could be implemented under a design-build scenario, or even by the district forces, both of which might be less expensive than the costs estimated in this analysis.

Table 2. Summary of range of percentage multipliers applied to cost estimate to account for indirect costs and contingencies.

Range of Percentages Applied to Total Direct Costs		
Engineering & Construction Management	10%	to 20%
Legal, Environmental and Administration	0%	to 20%
Total =	10%	to 40%
Percentage Applied to Total Site Cost		
Contingency	10%	to 20%

Quantities

Canal capacities were either determined through consultation with district operators or estimated using Manning’s equation for open channel flow using a combination of measured and assumed cross sectional geometry. For each canal, the top water width was measured at several locations using the point-to-point utility in Google Earth. Canal water depths were estimated based on spot field observations and by designating each canal a main, lateral, or sublateral canal. Average slopes along the canal lengths were estimated from Google Earth and USGS topographic maps. A Manning’s “n” of 0.033 was used assuming excavated earthen canals, winding and sluggish with grass and some weeds, as defined in Te Chow (1959)¹. Where available, calculated capacities were validated with measured capacities or typical peak diversions and globally adjusted as appropriate.

Quantities for larger heading and water level control structures were independently calculated and compared with conceptual structures designed for the Sutter Butte Regional Conveyance Study², conceptual structures in the WCWD Draft 20-Year Capital Improvements Plan, and with 60% design cost estimates³ for the BWGWD Gray Lodge Wildlife Area Supply Project.

Site Specific Improvement costs

For each site identified for improvements, applicable designs and base costs for typical sites were either used without modification, adjusted to reflect actual site conditions, or combined with components for other sites to create site specific improvement capital costs and annualized costs, as appropriate.

Annual costs

Annualized capital cost was estimated for each item using an amortization rate of 5 percent and capital recovery factors calculated using the estimated expected life of each cost item. Total annual costs also include annual operations and maintenance (O&M) costs. O&M costs were estimated as a percentage of the total extended cost of the item. The percentage ranged from 0 percent for items not requiring annual maintenance to 5 percent for electrical or mechanical components where more frequent O&M is necessary to ensure reliable operation and system longevity.

¹ Te Chow, Ven. 1959. Open Channel Hydraulics. The Blackburn Press, Caldwell, New Jersey, U.S.A.

² GEI Consultants, 2006. Regional Conveyance System Improvement Project – Final Report, May 2006. Completed for Sutter Extension Water District by Bookman-Edmonston, a division of GEI Consultants, Inc.

³ Engineer’s Opinion of Probable Construction Cost, 60% Design. October 2011. Prepared by Provost and Pritchard Consulting Engineers.

Project 1: System Modernization

Project Description

The system modernization project developed would allow SEWD to replace and improve existing infrastructure, to evaluate existing operations, and to develop and implement management strategies and tools to meet water management objectives, including water conservation at the district scale and improved delivery service to customers or to meet regional or statewide objectives. Additionally, SEWD has participated in efforts to explore increased system capacity to provide additional water to Sutter National Wildlife Refuge.

System modernization is generally implemented to achieve one or more of the following goals:

1. Increase the efficiency of the distribution system to conserve water at the district scale,
2. Increase the efficiency of the distribution system to irrigate additional land in times of shortage,
3. Increase the level of service provided to growers and respond to changes in cropping or irrigation method,
4. Reduce risks to the safety of operations staff, and
5. Improve the overall operability and management of the District.

A phased, comprehensive modernization plan provides a road map that allows for improvements to occur over time at a pace that considers available funds and implements priority improvements first to meet objectives in the most cost effective manner possible. Sites within each phase may be completed all at once, or on a prioritized basis, but improvements generally begin at the head of the system and proceed downstream to maximize benefits relative to implementation costs. The system modernization strategy for SEWD involves four phases and includes flow measurement as an overarching improvement. It is anticipated that the phasing of improvements of individual sites will differ from those described herein as informed by evaluation of opportunities, costs, and other considerations over time.

The system modernization program generally includes improvements to three site categories: Heading structures, upstream water level control structures, and spill structures. The objectives for each of these site types is described in Table 3. The specific improvements completed under each of the four phases of modernization is described in additional detail below.

Table 3. System Modernization Objectives by Site Category.

Site Category	General Modernization Objective
Heading	<ul style="list-style-type: none"> • Replace old, aging and/or deteriorated structures and equipment, as needed. • Provide increased accuracy, repeatability, and consistency in downstream deliveries to district customers prevent farm runoff and tail end spills. • Improve ability for flow adjustments to prevent spill and enhance delivery service. • Increase safety of site for operators.
Upstream Water Level Control	<ul style="list-style-type: none"> • Replace old, aging and/or deteriorated structures and equipment, as needed. • Maintain constant upstream deliveries by reducing fluctuation in desired upstream water level over a range of canal flow rates. • Simplify operations by reducing the need to add or remove flashboards to maintain water levels across a range of flows. • Facilitate the ability to make frequent flow changes through the system, as needed. • Consolidate safety spills by eliminating intermediate safety spills, where practical. • Increase safety site for operators.
Safety Spill	<ul style="list-style-type: none"> • Provide accurate and accessible measurement of spillage flow rate from the lateral as feedback on heading operation, general lateral operation, and district water accounting. • Increase safety of operating site.

Phase I System Modernization

The first phase would concentrate on primary inflow and operational outflow locations. These are generally the primary diversion locations or headings and main or primary canal end outflow points. The type and sophistication of improvement required to meet objectives varies by site, but the general objective is to provide improved control over the water that enters the district, as informed by improved information describing the timing and amount of water leaving the district. Readily accessible measurement of inflows and outflows has several benefits, including information for operational adjustments, data for water accounting and billing, and information to support prioritization of additional improvements by quantifying potential benefits.

SEWD has two primary supply points: the Sutter Butte Canal and the Sunset Pumps. The Sutter Butte Canal operated by the Joint Districts Board manager who coordinates releases with the California Department of Water Resources (DWR) operations staff for changes. Downstream from the heading, the Looney Gates provide upstream water level control for the Biggs Extension canal serving Biggs West Gridley Water District and Richvale Irrigation District. BWD is the primary operator of the Sutter Butte Canal below the Looney Gates and coordinates with SEWD to operate the canal to meet demands. Flows into the Sutter-Butte Canal are measured just downstream of the release point by DWR, and the Joint Districts Board operates an acoustic Doppler measurement site just downstream of the Looney Gates. Due to the Looney Gates operating at capacity during much of the irrigation season, substantial fluctuations in flow can pass to BWD and SEWD⁴. The Looney Gates are undersized for peak flows, thus also limiting supplies to BWD and SEWD. Construction of a higher capacity structure is recommended in the modernization plan for BWD and in a modernization plan developed for Joint District Board facilities

⁴ A modernization plan has been developed for the Joint Board as part of this Regional AWMP that would seek to remedy water level fluctuation issues in the Sutter Butte and Biggs Extension canals. The plan is included as Attachment ___.

upstream of and including the Looney Gates. Additionally, the Sutter-Butte Canal below the Cox Spill is undersized to convey the total demand required by SEWD which requires deficiencies to be met by the Sunset Pumps (at cost to SEWD). Increasing the capacity of the current canal would reduce the need to operate the pumps (a sizable benefit to SEWD) and has been explored by SEWD and BWD in a separate report⁵.

The Sunset pump station contains three pumps (one with a VFD) that are automated to maintain water level control upstream of the Smith Weir which is the first structure in the portion of the Sutter-Butte Canal that lies within SEWD, hereafter referred to as the Main Canal. The operation of this site has proved satisfactory given the sizable fluctuations that can occur upstream in the Sutter-Butte canal. The extra capacity of the pumps allows SEWD to better meet peak demand during rice flood-up.

Phase I recommendations would reconfigure the Smith Weir to provide downstream flow control instead of level control. As currently configured, the Smith Weir overpour design minimizes the head changes associated with a given flow fluctuation. This reduces the ability of the Sunset Pumps to fully regulate the flow because the fluctuation is partially passed downstream to the Main Canal. Because there is no spill point at this location, the new flow control structure would include emergency overpour weirs to pass flows to the Main Canal. However, historical operations suggest that the supply provided to SEWD by the Sutter-Butte Canal rarely (if ever) exceeds demand and the Sunset Pump are typically required to augment peak flows. This provides flexible control to accommodate flow fluctuations. In addition to these improvements, it is anticipated that the possible future modernization of the Sutter-Butte Canal with automated gates would include additional capacity to SEWD and minimize reliance on the Sunset Pumps. Therefore, the new Smith Weir/Heading would be designed considering future Sutter-Butte and Main Canal improvements where flow fluctuations would be passed down the canal to spill or be reregulated at the Interceptor Drain channel. A structure that could provide flow control in the near-term, but be easily reconfigured for upstream water level control in the future would be strategically advantageous and prudent from a cost perspective.

Accurate flow measurement at primary inflow locations is important to achieve modernization objectives because it allows for more accurate and precise management of inflows to the distribution system. Recommended improvements at the Smith Weir include installation of a flow measurement device downstream that would be used as basis for gate adjustments and be remotely monitored by the district manager and operators for improved operations and accounting.

The primary operational outflow locations in SEWD proposed for improvement are the Main Canal End Spill, the Clements Spill and the Farrington End Spill. Monitoring would inform operations and provide insight into additional phases of modernization. Additionally, following strategic rerouting of spills in later modernization phases, these sites will see greater concentration of remaining spills.

Phase II System Modernization

The second phase of modernization would improve key control points along the main supply canal between the headings and outflows to increase conveyance efficiency. This would include main canal water level control structures and lateral headings. Existing control sites may be abandoned in some cases, re-configured, retrofitted, downsized, or retained. The addition of Phase II improvements to

⁵ GEI Consultants, 2006. Regional Conveyance System Improvement Project – Final Report, May 2006. Completed for Sutter Extension Water District by Bookman-Edmonston, a division of GEI Consultants, Inc.

Phase I improvements would generally provide steadier delivery of water from the main canal to laterals and turnouts, simplify operations by adding automation and increased the ability to make flow changes, and concentrate primary routing of flow fluctuations along the main canal.

In SEWD (as in most open canal systems) the main canal contains flashboard check structures that require adjustment whenever there is a flow change to avoid impacts to deliveries to upstream laterals and turnouts along the canal. Without adjustment, undesirable water level fluctuations can impact these flows. In addition to impacting service, these fluctuations present challenges to water accounting and may ultimately spill if not needed.

The modernization strategy for the Main Canal is to provide new check structures that can pass flow fluctuations downstream while maintaining upstream water levels across a range of flows with limited fluctuation. In order to function over a wide range of flows, new primary check structures would incorporate long-crested weirs (LCWs) and a locally automated overshot gate. For purposes of the reconnaissance level cost estimates presented herein, the overshot gate is designed to pass between approximately 50% and 100% of the peak flow across its operating range while maintaining steady upstream water levels and also to pass relatively small day-to-day fluctuations without manual adjustment. Additionally, the incorporation of an overshot gate would allow the total water depth to be minimized to reduce seepage during rice field dry-down periods (i.e., August and September) but when deliveries for orchard irrigation or waterfowl habitat are desired. The long, fixed crest portion of the structure would effectively reduce the size of the overshot gate required, which would minimize the overall cost of the structure and, due to its long length, allow for passage of changes in flow with minimal changes in upstream water level.

A key focus of the modernization process is to select how and where flow fluctuations in excess of demands should be routed through the system. Consolidation and routing of fluctuations along one primary route increases the likelihood that they can be used to meet downstream demand, and allows for simplified monitoring of system operations to inform adjustments to diversions and upstream structures to reduce spillage. The ability to route flow fluctuations effectively is currently limited for two primary reasons. First, many main canal structures are unable to quickly pass fluctuations. As a result, the use of manually adjusted intermediate safety spills that provide temporary relief is required until flashboard adjustments can be made in the main canal. Secondly, primary division points are often not constructed with a designed preference for spill routing; rather, an equal split of fluctuations occurs in both directions due to both headings being of the same type (i.e., overshot or undershot). For manually controlled structures, overpour (weirs or overshot) style structures are better suited to maintain upstream water levels and pass fluctuations, while undershot (sluice or canal gate) structures are better suited to maintain constant flow, such as at a lateral heading.

In addition to passing flow fluctuations downstream, new overshot-style water level control structures enable steadier deliveries to laterals and to growers off the main canal by essentially fixing the upstream water level; however, upstream water level control is only part of the equation for maintaining constant delivery rates. Therefore, improvement of lateral headings along the main canal is also recommended. These improvements would include new adjustable undershot gates and downstream flow measurement. In particular, remote controlled automated flow control gates are recommended at the Farrington Lateral heading to allow frequent adjustment while manual heading gates are recommended for the other headings. The recommended measurement method for lateral headings depends on the

frequency of use and lateral size. In general, smaller, less frequently used laterals would be measured using propeller meters. Acoustic Doppler flow meters with continuous measurement capability are recommended for larger laterals.

The improvement of check structures and lateral headings along the main canal as described herein would establish the Main Canal as the primary spill route. Figure 1 provides an overview of all proposed improvement sites. A re-regulation point along the Main Canal at the Interceptor Canal/Peppard Flume is a cornerstone component of proposed system modernization and associated spill routing. The existing flume over the Interceptor Drain is currently used to reregulate flows in the Main Canal and also to make deliveries to the Sutter Bypass. Two drain recovery pumps are operated to augment supplies. Downstream of the existing flume, the Peppard Headgates effectively provide flow control and allow the flume overpour walls and the pumps to reregulate flow. Under the proposed modernization program, the flume would be reconfigured with fixed elevation weir crests, a dedicated delivery gate for metered deliveries to the drain, and installation of a new automated flow control structure at the Peppard Heading to enable remote adjustment of flow to meet downstream demands. One of the existing pumps would be fitted with VFD controls and automated to maintain the water level upstream of the heading gates.

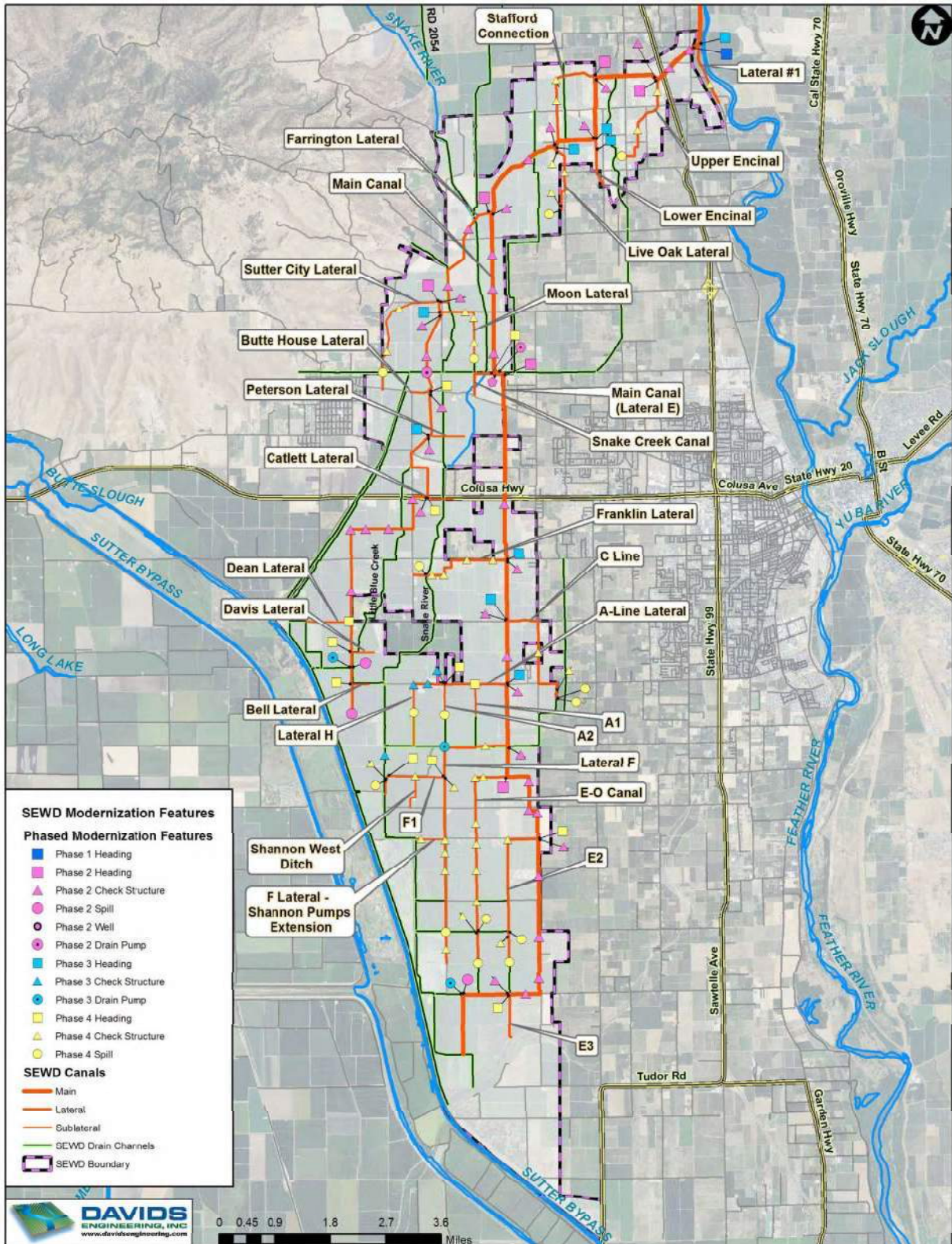

Figure 1. SEWD System Modernization Phasing and Improvement Sites.

[This Page Intentionally Blank]

Phase III System Modernization

Phase III would improve primary lateral control structures and primary end spills to improve control. Additionally, the Farrington Lateral has been identified as a candidate for improved routing of flow fluctuations and consolidation of spills to a single reregulation point at the Clarks Flume/Pumps at the Interceptor Drain. Replacing existing check structures along the Farrington Lateral with long crested weirs would provide constant upstream water levels with no adjustment required. Additionally, because of the long weir length, a small change in head corresponds to a large change in flow enabling more rapid transfer of flow fluctuations down the system because the required change in upstream pond storage to pass the change is minimized. At the flume site, a new flow control structure in the Farrington Lateral (downstream of the flume) would control flow to meet downstream demands, while excess flows could be released to the Interceptor Drain, or deficiencies could be overcome by recovering tailwater using the existing lift pumps. One of the existing pumps would be fit with a new variable frequency drive (VFD) to maintain upstream water levels.

Other laterals that would be improved under Phase III include the A-Line, F Lateral, F1 Lateral, Sutter City Lateral, Moon Lateral, and several end spills.

Phase IV System Modernization

The fourth phase would build on lateral heading flow control completed under Phases II and III, and lateral water level control completed under Phase III by improving secondary control points along laterals and sublateral control points. Additionally, minor or secondary safety spills are prioritized for improvement, although some intermediate safety spills would likely not be needed and could be abandoned as check structures are improved to allow routing of flow fluctuations without causing substantial water level fluctuations, capacities are increased, and the controllability of flows at heading structures is increased. Objectives are to increase flexibility, consistency, and adequacy of supply to sublaterals; increased delivery steadiness and consistency; and concentrated routing of flow fluctuations to a designated measurement location providing operators with feedback to help determine the status of deliveries or the need for a change at the lateral heading to improve operations. The fourth phase represents the final phase of system modernization to support spill reduction and possible diversion reduction, resulting in district-scale water conservation as well as increased levels of service.

The final phase would complete improvements to Upper Encinal lateral, Lower Encinal Lateral, Stafford Lateral, Live Oak Lateral, Franklin Lateral, C-Line, E-O Lateral, E2 lateral, E3 Lateral, A1 Lateral, A1 Lateral, Joaquin Humphrey, Peterson Lateral, Catlett Lateral, Dean Lateral, Davis Lateral, Bell Lateral, F1 Lateral, and several minor spills.

Inventory of Existing Conditions

Existing conditions were characterized through consultation with District operations staff. For each site type, representative sites were selected for field inspection to obtain dimensions, coordinates, photos and operational features typical of the site type to aid in strategy development and cost estimation. These sites included primary control points. Table 4 provides the site name, the site type, latitude, longitude, and a description of existing conditions for each site to be improved under the System Modernization project. Sites were assigned to one of the following categories: Inflow, Heading, Water

Level Control, or Safety Spill. The system modernization plan described herein focuses on primary and secondary control points and other system components and may not be exhaustive.

Table 4. Inventory of Existing Conditions.

Site Name	Site Type	Latitude	Longitude	Description of Existing Conditions
Sunset Pumping Plant	Inflow	39.248	-121.637	Three pumps (one with VFD) that operate to maintain water level in Sutter-Butte Canal.
Smith Weir	Water Level Control	39.246	-121.640	Eight 4' wide bays with a canal gate installed in one.
Main Canal End Spill	Spill	39.025	-121.713	Concrete headwall with 3ft wide flashboard bay
Clements Spill	Spill	39.102	-121.746	Concrete headwall with 3ft wide flashboard bay
Farrington Lateral End Spill	Spill	39.091	-121.745	2ft wide weir box with flashboards
Lateral #1 Headgate	Heading	39.247	-121.638	4' rectangular slide gate and concrete headwall 48" diameter pipe section
Cutting Weir	Water Level Control	39.242	-121.647	Seven 4' wide flashboard bays
Upper Encinal Lateral/Butler Weir	Heading and Water Level Control	39.239	-121.651	30" diameter sluice gate mounted to concrete headwall with short section of pipe downstream. Six 4' wide bays with a canal gate installed in one.
Stafford Connection Lateral/Stafford Weir	Heading and Water Level Control	39.240	-121.670	Six 4' wide bays with a canal gate installed in one. Concrete structure with 30" diameter sluice gate with two 3 ft wide flashboard bays.
Lower Encinal Lateral/Kerrigan Weir	Heading and Water Level Control	39.225	-121.669	Eight 4' wide bays with a canal gate installed in one. Concrete headwall with undershot gate. Short section of pipe attached downstream before discharge into open canal. 20cfs capacity
Live Oak Lateral/Broadway Weir	Heading and Water Level Control	39.224	-121.681	Six 4' wide bays with a canal gate installed in one. Concrete structure with undershot gate. Inlet pipe siphons under RD777 drain channel.
Harrington Weir	Water Level Control	39.221	-121.690	Six 4' wide flashboard bays
Farrington Lateral/Sanders Weir	Heading and Water Level Control	39.208	-121.702	Five 3ft wide bays in total. Three contain canal gates and two with flashboards. Eight, 3ft wide flashboard bays
Anderson Weir #1	Water Level Control	39.199	-121.701	Concrete headwall with several flashboard bays
Anderson Weir #2	Water Level Control	39.190	-121.701	

Site Name	Site Type	Latitude	Longitude	Description of Existing Conditions
Anderson Weir #3	Water Level Control	39.175	-121.701	
Peppard Re Regulation Structure	Flow Control	39.171	-121.700	75hp and 30hp drain recovery pumps. Flume is constructed of wood planks and has eight 3ft wide flashboard bays for delivery or spill to Interceptor Drain. Peppard Headgate structure contains four 4ft wide undershot gates and four flashboard bays and is situated 770 feet downstream from flume.
Highway 20 Weir	Water Level Control	39.140	-121.698	Eight 3' wide flashboard bays
Franklin Lateral/Franklin Weir	Heading and Water Level Control	39.127	-121.698	Eight 3' wide flashboard bays. Concrete headwall with undershot gate
C-Line Lateral/Lincoln Weir	Heading and Water Level Control	39.113	-121.698	Eight 3' wide flashboard bays. Concrete headwall with undershot gate
Rodoff Weir	Water Level Control	39.104	-121.698	Five, 4ft wide flashboard bays
A-Line Lateral/Bogue Weir	Heading and Water Level Control	39.098	-121.699	Five, 4ft wide flashboard bays. Concrete headwall with undershot gate
F- Lateral/Daphine Lane Weir	Heading and Water Level Control	39.084	-121.699	Water level control structure is a concrete structure with several manually operated flashboard bays. Lateral heading consists of concrete headwall and undershot gate.
E-O Lateral/Main Canal Weir	Heading and Water Level Control	39.076	-121.699	
E2 Lateral/ Main Canal Weir	Heading and Water Level Control	39.061	-121.690	
E3 Lateral/Main Canal Weir	Heading and Water Level Control	39.025	-121.699	
Lower Main Weirs	Water Level Control	Several Locations		Concrete headwall with several flashboard bays
Upper Encinal Spill	Spill	39.221	-121.662	Concrete weir box with adjustable weir boards to control water level and spill point.
Live Oak Spill	Spill	39.209	-121.680	

Site Name	Site Type	Latitude	Longitude	Description of Existing Conditions
Franklin Spill	Spill	39.124	-121.722	2ft wide weir box with flashboards. Discharge piping empties to drain
A-Line Weirs	Water Level Control	Several Locations		Concrete headwall with several manually operated flashboard bays
F Weirs	Water Level Control	Several Locations		Concrete headwall with several manually operated flashboard bays
Farrington Lateral Weirs	Water Level Control	Several Locations		Concrete headwall with several manually operated flashboard bays
A-Line Spill	Spill	39.091	-121.727	Concrete weir box with adjustable weir boards to control water level and spill point.
C-Line Spill	Spill	39.094	-121.684	
F1 Headgate	Heading	39.076	-121.718	Concrete headwall with manually operated undershot gate
F Spill	Spill	39.040	-121.718	Concrete weir box with adjustable weir boards to control water level and spill point.
E-O Spills	Spill	39.033	-121.709	
E2 Spills	Spill	39.033	-121.699	
Sutter City Lateral	Heading	39.188	-121.717	36" sluice gate with short section of CMP attached downstream. 40cfs capacity. Concrete structure with three, 4ft wide flashboard bays.
Moon Lateral	Heading	39.185	-121.717	Water level control structure is a concrete structure with several manually operated flashboard bays. Lateral heading consists of concrete headwall and undershot gate.
Clark Pump Re Regulation Structure	Flow Control	39.171	-121.721	Three pumps (40hp, 30hp, and 25hp) pump tailwater from Interceptor canal into Farrington Lateral. Pumps use Warrick Controls to maintain water levels in canal. Flume has two 2ft wide weir bays to spill to Interceptor.
Upper Encinal Lateral Weirs	Water Level Control	Several Locations		Concrete structures with several manually operated flashboard bays
Lower Encinal lateral Weirs	Water Level Control	Several Locations		
Stafford Weirs	Water Level Control	Several Locations		
Live Oak Weirs	Water Level Control	Several Locations		
Franklin Weirs	Water Level Control	Several Locations		
C-Line Weirs	Water Level Control	Several Locations		

Site Name	Site Type	Latitude	Longitude	Description of Existing Conditions
E-O Weirs	Water Level Control	Several Locations		
E2 Weirs	Water Level Control	Several Locations		
E3 Weirs	Water Level Control	Several Locations		
A1 Headgate	Heading	39.098	-121.708	Concrete headwall with manually operated undershot gate
A2 Headgate	Heading	39.098	-121.717	
Joaquin Humphrey Lateral Headgate	Heading	39.167	-121.721	
Peterson Lateral Headgate	Heading	39.156	-121.721	
Catlett Lateral Headgate	Heading	39.142	-121.722	
Dean Lateral Headgate	Heading	39.113	-121.746	
Davis Lateral Headgate	Heading	39.106	-121.745	
Bell Lateral Headgate	Heading	39.098	-121.745	
F1 Heading	Heading	39.076	-121.718	
F1 Spill	Spill	39.076	-121.735	
Frog Slough Spill	Spill	39.171	-121.735	Single flashboard bay in concrete headwall with adjustable boards

System Modernization Physical and Operational Improvements

Level 1 and 2 Improvements

Each phase includes individual sites. For each site, improvement is split into two levels, Level 1 and Level 2. Level 1 improvements typically include fundamental infrastructure and measurement enhancements that are manually operated or read, or locally automated, and designed as SCADA-Ready⁶. These improvements include, but not limited to new, manually adjustable heading gates; long crested weirs; locally automated overshot gates; and measurement devices such as weirs, acoustic Doppler flow meters, and propeller meters. Level 2 improvements build upon Level 1 improvements by automating certain additional features, adding electronic sensors, installing on-site digital display of flow

⁶ "SCADA-Ready" describes a package of hardware and/or software that communicates and operates locally but has been specifically designed and installed to readily accept a data transmission and receiving device (e.g. radio, cellular modem, etc.) and to provide remote communication with an established base station and SCADA human machine interface (HMI).

rate or other parameters, or adding remote monitoring or control through a Supervisory Control and Data Acquisition System (SCADA). Level 1 improvements are stand-alone, while Level 2 improvements generally require Level 1 to be completed prior to or at the same time. The progression from level 1 to level 2 improvements provides the flexibility to complete Level 1 (which has significant benefits on its own) while assessing the benefits of SCADA, further prioritizing sites, establishing a SCADA base station, and gradually implementing potentially more complex and technically intricate remote control sites.

Although Level 2 is not universally required to be completed, several sites would substantially benefit. Two examples of this are:

1. Remotely located end spill sites not frequently visited by operators. Remote monitoring would reduce travel time potentially enabling additional flow changes, as needed.
2. Automated flow control gates at headings with substantial upstream water level fluctuations; however, assuming water level control structures are installed, the flow control device could have little additional benefit.

Table 5 provides a description of the improvements proposed for each site, the objective of the improvements and estimated Phase I and Phase II improvement costs. For each site and level of improvements, upfront capital costs and annualized capital, operations, and maintenance costs are provided. All costs are subject to revision following refinement of site improvements as informed by more detailed review and design. In some cases, there could be capital cost savings by completing Level 1 and Level 2 improvements at the same time.

Table 5. Site Improvement Matrix.

Site Name	Site Type	Description of Operational Objective with Improvements	Level 1 Modernization and Enhancement	Capital Cost (\$)	Annual Cost (\$/yr)	Level 2 Modernization and Enhancement	Capital Cost (\$)	Annual Cost (\$/yr)
SCADA Office Base Station		Allows remote monitoring of measured parameters at SCADA equipped sites. Also allows remote control and adjustment of set points at automated water level or flow control sites. Provides for storage of data and interface for developing comprehensive status reports, usage statistics, and monitoring information for improved water management, accounting and reporting.	Level 1 Modernization and Enhancement does not include SCADA at sites; therefore, base station is not required.	\$0	\$0	Furnish and install one desktop personal computer, including: processor, monitor, keyboard, mouse, drivers, USB, RS232, Ethernet, communication ports, cables, adapters, modems, printer, operating system software and HMI software. Base station spread spectrum radio, mast, and antenna for communication with remote sites. Five hardened laptops and vehicle mounts for operator/in-field use. Vehicle-mounted radios and antennas for remote communications and monitoring of sites.	\$138,063	\$17,039
Spare Equipment		Minimize down time associated with simple equipment maintenance or malfunctions and/or procurement of site or system specific hardware.	Small inventory of site and system specific equipment that is critical for proper operation of improvements.	\$23,692	\$2,913		\$0	\$0
Phase I Modernization - Improvement of Primary Inflow Locations and Primary Operational Outflow Locations								
Sunset Pumping Plant	Inflow	Provide improved measurement of discharge flow from the three existing pumps for water accounting purposes and to improve operations.	Install flow measurement devices on each of the three discharge pipes. Install digital flow display. Site will be SCADA-Ready.	\$21,000	\$1,150	Install communication hardware and integrate with SCADA system to allow remote monitoring.	\$11,800	\$1,200
Smith Weir	Water Level Control	Reconfigure existing upstream water level control structure to function as a flow control structure to provide operators with the infrastructure and equipment to provide accurate, repeatable and consistent flow rates to meet downstream demand. Sunset Pumps are automated to maintain constant upstream water level. Structure will also contain emergency bypass overpour bays.	Install five additional undershot gates in place of overshoot structures. Retain two overpour weirs for emergency spills.	\$48,500	\$3,500	Replace existing concrete structure with new, higher capacity concrete structure. Add automated flow control gate(s) with sufficient capacity for daily adjustments and manual gates for typical base flow. Leave two bays in overpour configuration for emergency spill. Install solar power system, digital display, PLC and integrate with SCADA system to allow remote manual adjustment of set points and monitoring of flow rate, water levels and gate function.	\$251,020	\$19,800
SEWD Main Canal Inflow	Flow Measurement	Provide measurement of delivered flow to Sutter Extension Water District to allow operators to make more informed adjustments and to improve water accounting.	Install ADVM downstream from gates in straight section of channel. Perform velocity index calibration. Install digital display of flow rate at heading gates to inform adjustments.	\$55,400	\$5,300	Install communication hardware and integrate with SCADA system to allow remote monitoring.	\$5,900	\$600
Main Canal End Spill	Spill	Provide accurate and accessible measurement of spillage flow rate from the Main Canal as feedback loop on heading operation, general lateral operation, and for improved District water accounting. Spillage records will help inform the modernization process.	Install sharp crested weir plate and mount custom staff gage calibrated to report spill flow rate based on the depth of water above the weir crest.	\$8,700	\$700	Install pressure transducer in new stilling well upstream of spill box to measure head on weir. Perform calibration of weir. Install communication hardware and integrate with SCADA system to allow remote monitoring.	\$15,400	\$1,500
Clements Spill	Spill	Provide accurate and accessible measurement of spillage flow rate from the Farrington Lateral as feedback loop on heading operation, general lateral operation, and for improved District water accounting. Spillage records will help inform the modernization process.		\$8,700	\$700		\$15,400	\$1,500
Farrington Lateral End Spill	Spill			\$8,700	\$700		\$15,400	\$1,500
Phase II Modernization - Improvement of Main Canal Primary Control Points								

Site Name	Site Type	Description of Operational Objective with Improvements	Level 1 Modernization and Enhancement	Capital Cost (\$)	Annual Cost (\$/yr)	Level 2 Modernization and Enhancement	Capital Cost (\$)	Annual Cost (\$/yr)
Lateral #1 Headgate	Heading	Provide accurate, repeatable and consistent flow to supply deliveries downstream of the lateral heading.	Install weir box on downstream end of existing pipe at heading and install open channel propeller meter. Install trash rack at inlet. Sunset Pumps provide upstream water level control. Site will be SCADA-Ready.	\$26,400	\$2,400	Install communication hardware and integrate with SCADA system to allow remote monitoring.	\$11,800	\$1,200
Cutting Weir	Water Level Control	Maintain upstream water level for constant upstream deliveries and to route any flow fluctuations down the Main Canal to the proposed re regulation point at the Peppard Flume.	Replace existing weir structure in Main Canal with combination water level control structure with locally automated overshoot gate set to maintain upstream water level.	\$595,300	\$44,300	Add communication hardware and integrate with SCADA system to allow remote manual adjustment of set points and monitoring of water levels and gate function.	\$7,400	\$700
Upper Encinal Lateral/Butler Weir	Heading and Water Level Control		Replace Butler Weir with new water level control structure that incorporates locally automated overshoot gate. Install weir box on downstream end of existing lateral heading pipe and install open channel propeller meter. Replace heading gate as necessary to provide adjustable and reliable control. Site will be SCADA-Ready.	\$621,700	\$46,700		\$7,400	\$700
Stafford Connection Lateral/Stafford Weir	Heading and Water Level Control	Provide accurate, repeatable and consistent flow to supply deliveries downstream of the lateral heading. Replacement or retrofit of the existing water level control structure in the Main Canal (downstream of the lateral heading) will minimize water level fluctuations and quickly route excesses in supply to the proposed re regulation point at the Peppard Flume	Replace Stafford Weir with new water level control structure that incorporates locally automated overshoot gate. Construct control section downstream of existing Stafford Connection headgates and install ADVM. Install solar power system, digital flow display and related components. Perform velocity index calibration on existing ADVM device. Site will be SCADA-Ready.	\$637,300	\$48,400	Add communication hardware and integrate with SCADA system to allow remote manual adjustment of set points, monitoring of water levels, overshoot gate function, and lateral flow rate.	\$7,400	\$700
Lower Encinal Lateral/Kerrigan Weir	Heading and Water Level Control		Replace weirs (Kerrigan and Broadway) with new water level control structure that incorporates locally automated overshoot gate. Install weir box on downstream end of existing lateral heading pipe and install open channel propeller meter. Replace heading gate as necessary to provide adjustable and reliable control. Site will be SCADA-Ready.	\$621,700	\$46,700		\$7,400	\$700
Live Oak Lateral/Broadway Weir	Heading and Water Level Control		Replace existing weir structure in Main Canal with combination water level control structure with locally automated overshoot gate set to maintain upstream water level.	\$621,700	\$46,700		\$7,400	\$700
Harrington Weir	Water Level Control	Maintain upstream water level for constant upstream deliveries and to route any flow fluctuations down the Main Canal to the proposed re regulation point at the Peppard Flume	Replace existing weir structure in Main Canal with combination water level control structure with locally automated overshoot gate set to maintain upstream water level.	\$595,300	\$44,300	Add communication hardware and integrate with SCADA system to allow remote manual adjustment of set points and monitoring of water levels and gate function.	\$7,400	\$700

Site Name	Site Type	Description of Operational Objective with Improvements	Level 1 Modernization and Enhancement	Capital Cost (\$)	Annual Cost (\$/yr)	Level 2 Modernization and Enhancement	Capital Cost (\$)	Annual Cost (\$/yr)
Farrington Lateral/Sanders Weir	Heading and Water Level Control	Provide accurate, repeatable and consistent flow to supply deliveries downstream of the lateral heading. Replacement or retrofit of the existing water level control structure in the Main Canal (downstream of the lateral heading) will minimize water level fluctuations and quickly route excesses in supply to the proposed re regulation point at the Peppard Flume	Replace Sanders Weir with new water level control structure that incorporates locally automated overshoot gate. Construct control section downstream of existing Farrington Lateral headgates and install ADVM. Install solar power system, digital flow display and related components. Perform velocity index calibration on existing ADVM device. Site will be SCADA-Ready.	\$637,300	\$48,400	Replace existing Farrington Lateral Heading with automated flow control structure. Add communication hardware and integrate with SCADA system to allow remote manual adjustment of set points, monitoring of water levels, control of gate function, and lateral flow rate.	\$209,000	\$15,100
Anderson Weir #1	Water Level Control	Maintain upstream water level for constant upstream deliveries and to route any flow fluctuations down the Main Canal to the proposed re regulation point at the Peppard Flume	Replace existing weir structure in Main Canal with combination water level control structure with locally automated overshoot gate set to maintain upstream water level.	\$595,300	\$44,300	Add communication hardware and integrate with SCADA system to allow remote manual adjustment of set points and monitoring of water levels and gate function.	\$7,400	\$700
Anderson Weir #2	Water Level Control			\$595,300	\$44,300		\$7,400	\$700
Anderson Weir #3	Water Level Control			\$595,300	\$44,300		\$7,400	\$700
Peppard Re Regulation Structure	Flow Control	Re regulate flow in the Main Canal to provide constant flow rate to downstream deliveries. Excesses in supply in the Main Canal are spilled instead of being passed downstream, and any deficiencies in flow rate may be made up by extracting tailwater from the Interceptor Drain.	Install VFD and automate drain pumps to maintain water level upstream of the Peppard Headgates. Reconstruct flume walls to act as long crested weirs with crest elevation set to maintain water levels at high water mark. Construct control section downstream from Peppard Headgates and install ADVM. Install metered outlet to Interceptor Drain for deliveries to SNWR. Install solar power system, flow display and related components. Perform velocity index calibration. Site will be SCADA-Ready.	\$69,600	\$5,743	Add new automated flow control gate(s) at Peppard Headgates with sufficient capacity for daily adjustments. Retain manual gates for typical base flow in remaining bays. Install solar power system, digital display, PLC and integrate with SCADA system to allow remote manual adjustment of set points and monitoring of flow rate, water levels, VFD function and gate function.	\$106,700	\$7,800
Highway 20 Weir	Water Level Control	Maintain upstream water level for constant upstream deliveries and to route any flow fluctuations down the Main Canal to the Main Canal end spill	Replace existing weir structure in Main Canal with combination water level control structure with locally automated overshoot gate set to maintain upstream water level.	\$250,300	\$18,900	Add communication hardware and integrate with SCADA system to allow remote manual adjustment of set points and monitoring of water levels and gate function.	\$7,400	\$700
Franklin Lateral/Franklin Weir	Heading and Water Level Control	Provide accurate, repeatable and consistent flow to supply deliveries downstream of the lateral heading. Replacement or retrofit of the existing water level control structure in the Main Canal (downstream of the lateral heading) will minimize water level fluctuations and quickly route excesses in supply to the Main Canal end spill	Replace weirs (Franklin and Lincoln) with new water level control structure that incorporates locally automated overshoot gate. Install weir box on downstream end of existing lateral heading pipe and install open channel propeller meter. Replace heading gate as necessary to provide adjustable and reliable control. Site will be SCADA-Ready.	\$276,700	\$21,300	Add communication hardware and integrate with SCADA system to allow remote manual adjustment of set points, monitoring of water levels, overshoot gate function, and lateral flow rate.	\$7,400	\$700
C-Line Lateral/Lincoln Weir	Heading and Water Level Control			\$276,700	\$21,300		\$7,400	\$700

Site Name	Site Type	Description of Operational Objective with Improvements	Level 1 Modernization and Enhancement	Capital Cost (\$)	Annual Cost (\$/yr)	Level 2 Modernization and Enhancement	Capital Cost (\$)	Annual Cost (\$/yr)
Rodoff Weir	Water Level Control	Maintain upstream water level for constant upstream deliveries and to route any flow fluctuations down the Main Canal to the Main Canal end spill	Replace existing weir structure in Main Canal with combination water level control structure with manually controlled overshoot gate.	\$250,300	\$18,900	Add communication hardware and integrate with SCADA system to allow remote manual adjustment of set points and monitoring of water levels and gate function.	\$7,400	\$700
A-Line Lateral/Bogue Weir	Heading and Water Level Control	Provide accurate, repeatable and consistent flow to supply deliveries downstream of the lateral heading. Replacement or retrofit of the existing water level control structure in the Main Canal (downstream of the lateral heading) will minimize water level fluctuations and quickly route excesses in supply to the Main Canal end spill	Replace Bogue and Daphine weirs with new water level control structure that incorporates manually controlled overshoot gate. Install weir box on downstream end of existing lateral heading pipe and install open channel propeller meter. Replace heading gate as necessary to provide adjustable and reliable control. Site will be SCADA-Ready.	\$276,700	\$21,300	Add communication hardware and integrate with SCADA system to allow remote manual adjustment of set points, monitoring of water levels, overshoot gate function, and lateral flow rate.	\$7,400	\$700
F-Lateral/Daphine Lane Weir	Heading and Water Level Control		Replace weirs with new standard LCWs. Install weir box on downstream end of existing lateral heading pipe and install open channel propeller meter. Replace heading gate as necessary to provide adjustable and reliable control. Site will be SCADA-Ready.	\$79,500	\$5,800	Install communication hardware and integrate with SCADA system to allow remote monitoring.	\$5,900	\$600
E-O Lateral/Main Canal Weir	Heading and Water Level Control		Replace five existing check structures below E2 Lateral with LCWs.	\$79,500	\$5,800	Install communication hardware and integrate with SCADA system to allow remote monitoring.	\$5,900	\$600
E2 Lateral/Main Canal Weir	Heading and Water Level Control	Maintain constant upstream deliveries by maintaining the desired upstream water level in the supply canal over a range of canal flow rates. Simplify operations by reducing the need to add or remove flashboards, and increase the rate at which flow changes can be passed through the system	Replace three existing check structures with LCWs.	\$241,100	\$15,400	None	\$0	\$0
E3 Lateral/Main Canal Weir	Heading and Water Level Control							
Lower Main Weirs	Water Level Control							
Phase III Modernization - Improvement of Lateral Primary Control Points and Spill Routing								
Upper Encinal Spill	Spill	Provide accurate and accessible measurement of spillage flow rate from the lateral as feedback loop on heading operation, general lateral operation, and District water accounting.	Install sharp crested weir plate and mount custom staff gage calibrated to report spill flow rate based on the depth of water above the weir crest.	\$8,700	\$700	Install pressure transducer in new stilling well upstream of spill box to measure head on weir. Perform calibration of weir. Install communication hardware and integrate with SCADA system to allow remote monitoring.	\$15,400	\$1,500
Live Oak Spill	Spill							
Franklin Spill	Spill							
A-Line Weirs	Water Level Control	Maintain constant upstream deliveries by maintaining the desired upstream water level in the supply canal over a range of canal flow rates. Simplify operations by reducing the need to add or remove flashboards, and increase the rate at which flow changes can be passed through the system	Replace six existing check structures with LCWs.	\$122,700	\$7,800	None	\$0	\$0
F Weirs	Water Level Control							
Farrington Lateral Weirs	Water Level Control							
A-Line Spill	Spill	Provide accurate and accessible measurement of spillage flow rate from the lateral as feedback loop on heading operation, general lateral operation, and District water accounting.	Install sharp crested weir plate and mount custom staff gage calibrated to report spill flow rate based on the depth of water above the weir crest.	\$8,700	\$700	Install pressure transducer in new stilling well upstream of spill box to measure head on weir. Perform calibration of weir. Install communication hardware and integrate with SCADA system to allow remote monitoring.	\$15,400	\$1,500
C-Line Spill	Spill							

Site Name	Site Type	Description of Operational Objective with Improvements	Level 1 Modernization and Enhancement	Capital Cost (\$)	Annual Cost (\$/yr)	Level 2 Modernization and Enhancement	Capital Cost (\$)	Annual Cost (\$/yr)
F1 Headgate	Heading	Provide accurate, repeatable and consistent flow to supply deliveries downstream of the sublateral heading.	Install weir box on downstream end of existing pipe at heading and install open channel propeller meter. Install trash rack at inlet. Replace heading gate as necessary to provide adjustable and reliable control. Site will be SCADA-Ready.	\$26,400	\$2,400	Install communication hardware and integrate with SCADA system to allow remote monitoring.	\$11,800	\$1,200
F Spill	Spill	Provide accurate and accessible measurement of spillage flow rate from the lateral as feedback loop on heading operation, general lateral operation, and District water accounting.	Replace weir box with new concrete structure. Install sharp crested weir plate and mount custom staff gage calibrated to report spill flow rate based on the depth of water above the weir crest.	\$8,700	\$700	Install pressure transducer in new stilling well upstream of spill box to measure head on weir. Perform calibration of weir. Install communication hardware and integrate with SCADA system to allow remote monitoring.	\$15,400	\$1,500
E-O Spills	Spill			\$8,700	\$700		\$15,400	\$1,500
E2 Spills	Spill			\$8,700	\$700		\$15,400	\$1,500
Sutter City Lateral	Heading	Provide accurate, repeatable and consistent flow to supply deliveries downstream of the lateral heading. Replacement or retrofit of the existing water level control structure in the Main Canal (downstream of the lateral heading) will minimize water level fluctuations and quickly route excesses in supply to the Clark Pump re regulation point.	Install weir box on downstream end of existing pipe at heading and install open channel propeller meter. Install trash rack at inlet. Replace heading gate as necessary to provide adjustable and reliable control. Site will be SCADA-Ready.	\$26,400	\$2,400	Install communication hardware and integrate with SCADA system to allow remote monitoring.	\$11,800	\$1,200
Moon Lateral	Heading			\$26,400	\$2,400		\$11,800	\$1,200
Clark Pump Re Regulation Structure	Flow Control	Re regulate flow in the Farrington Lateral to provide constant flow rate to downstream deliveries. Excesses in supply in the Farrington Lateral are spilled instead of being passed downstream, and any deficiencies in flow rate may be made up by extracting tailwater from the Interceptor Drain.	Construct new Clark Headgates just downstream of flume with several undershot gates. Install VFD and automate drain pumps to maintain water level upstream of the new headgates. Reconstruct flume walls to act as long crested weirs with crest elevation set to maintain water levels at high water mark. Construct control section downstream from new headgates and install ADVM. Install solar power system, flow display and related components. Perform velocity index calibration. Site will be SCADA-Ready.	\$211,200	\$15,343	Add new automated flow control gate(s) with sufficient capacity for daily adjustments and retain manual gates for typical base flow at Clark Heading. Install solar power system, digital display, PLC and integrate with SCADA and monitoring of flow rate, water levels, VFD function and gate function.	\$82,060	\$7,000
Phase IV Modernization - Improvement of Lateral Secondary Points and Sublateral Control Points and Secondary Spill Points								
Upper Encinal Lateral Weirs	Water Level Control		Replace two existing check structures with LCWs.	\$81,800	\$5,200	None	\$0	\$0
Lower Encinal lateral Weirs	Water Level Control		Replace one existing check structure with a LCW.	\$40,900	\$2,600	None	\$0	\$0
Stafford Weirs	Water Level Control	Maintain constant upstream deliveries by maintaining the desired upstream water level in the supply canal over a range of canal flow rates. Simplify operations by reducing the need to add or remove flashboards, and increase the rate at which flow changes can be passed through the system	Replace two existing check structures with LCWs.	\$106,200	\$6,800	None	\$0	\$0
Sutter City Lateral Weirs	Water Level Control		Replace two existing check structures with LCWs.	\$81,800	\$5,200		\$0	\$0
Moon Lateral Weirs	Water Level Control		Replace three existing check structures with LCWs.	\$66,600	\$4,200		\$0	\$0
Live Oak Weirs	Water Level Control		Replace three existing check structures with LCWs.	\$66,600	\$4,200	None	\$0	\$0

Site Name	Site Type	Description of Operational Objective with Improvements	Level 1 Modernization and Enhancement	Capital Cost (\$)	Annual Cost (\$/yr)	Level 2 Modernization and Enhancement	Capital Cost (\$)	Annual Cost (\$/yr)
Franklin Weirs	Water Level Control		Replace four existing check structures with LCWs.	\$88,800	\$5,600	None	\$0	\$0
C-Line Weirs	Water Level Control		Replace two existing check structures with LCWs.	\$44,400	\$2,800	None	\$0	\$0
F1 Lateral Weirs	Water Level Control		Replace one existing check structures with LCWs.	\$22,200	\$1,400		\$0	\$0
E-O Weirs	Water Level Control		Replace five existing check structures with LCWs.	\$204,500	\$13,000	None	\$0	\$0
E2 Weirs	Water Level Control		Replace two existing check structures with LCWs.	\$44,400	\$2,800	None	\$0	\$0
E3 Weirs	Water Level Control		Replace two existing check structures with LCWs.	\$44,400	\$2,800	None	\$0	\$0
A1 Headgate	Heading			\$26,400	\$2,400		\$11,800	\$1,200
A2 Headgate	Heading			\$26,400	\$2,400		\$11,800	\$1,200
Joaquin Humphrey Lateral Headgate	Heading			\$26,400	\$2,400		\$11,800	\$1,200
Peterson Lateral Headgate	Heading	Provide accurate, repeatable and consistent flow to supply deliveries downstream of the lateral heading.	Install weir box on downstream end of existing pipe at heading and install open channel propeller meter. Install trash rack at inlet. Replace heading gate as necessary to provide adjustable and reliable control. Site will be SCADA-Ready.	\$26,400	\$2,400	Install communication hardware and integrate with SCADA system to allow remote monitoring.	\$11,800	\$1,200
Cattlett Lateral Headgate	Heading			\$26,400	\$2,400		\$11,800	\$1,200
Dean Lateral Headgate	Heading			\$26,400	\$2,400		\$11,800	\$1,200
Davis Lateral Headgate	Heading			\$26,400	\$2,400		\$11,800	\$1,200
Bell Lateral Headgate	Heading			\$26,400	\$2,400		\$11,800	\$1,200
F1 Spill	Spill	Provide accurate and accessible measurement of spillage flow rate from the lateral as feedback loop on heading operation, general lateral operation, and District water accounting.	Install sharp crested weir plate and mount custom staff gage calibrated to report spill flow rate based on the depth of water above the weir crest.	\$8,700	\$700	Install pressure transducer in new stilling well upstream of spill box to measure head on weir. Perform calibration of weir. Install communication hardware and integrate with SCADA system to allow remote monitoring.	\$15,400	\$1,500
Frog Slough Spill	Spill			\$8,700	\$700		\$15,400	\$1,500

System Modernization Costs

The total combined cost (all phases, Level 1 and Level 2) of system modernization is estimated to be approximately \$12,822,000, with annualized estimated costs of \$961,000. Individual costs by modernization phase range from a low of \$433,000 to a high of \$8,755,000 for Phase I and Phase II, respectively. Costs are further summarized in Table 6. Additionally, the costs of a SCADA base station and mobile operator terminals that would form the backbone of the district SCADA system have been estimated, along with the cost of spare equipment to be kept on hand to repair or replace individual site components due to theft, vandalism, or other failure. The cost of the office base station may be drastically reduced, or eliminated, if the district is able to ‘piggy-back’ on to and expand the existing SCADA network current owned and operated by the Joint Districts Board.

Table 6. Summary of Estimated Capital and Annualized Costs.

<u>Modernization Phase</u>	<u>Level 1</u>		<u>Level 2</u>	
	<u>Capital Cost (\$)</u>	<u>Annual Cost (\$/yr)</u>	<u>Capital Cost (\$)</u>	<u>Annual Cost (\$/yr)</u>
Phase I - Improvement of Primary Inflow Locations and Primary Operational Outflow Locations	\$130,000	\$10,900	\$303,120	\$24,900
Phase II - Improvement of Main Canal Primary Control Points	\$8,299,200	\$622,343	\$456,200	\$36,400
Phase III - Improvement of Lateral Primary Control Points and Spill Routing	\$2,146,200	\$153,743	\$240,660	\$22,600
Phase IV - Improvement of Lateral Secondary Points, Sublateral Control Points and Secondary Spill Points	\$1,121,200	\$77,200	\$125,200	\$12,600
Total Cost =	\$11,696,600	\$864,187	\$1,125,180	\$96,500
SCADA Office Base Station	-	-	\$138,063	\$17,039
Spare Parts	\$23,692	\$2,913		-

Potential Benefits

The system modernization plan described herein represents comprehensive improvements of the district’s distribution system, adding several automated control structures, improved measurement, new heading structures, re-regulation points, and SCADA. Flow paths targeted under of the system modernization project are:

- Operational spillage,
- Deliveries to customers,
- Tailwater,
- Diversions, and
- Drainage outflows

Improvements would allow reduced operational spillage and reduced deliveries due to increased delivery efficiency, which would reduce on-farm tailwater and, in some cases, deep percolation. Reduced deliveries result in reduced diversions, which results in corresponding reductions in spillage and drainage outflows. Available water not diverted remains in storage and could potentially be

available for transfer or to meet local unmet demands. Additionally, water quality benefits may occur through reduced tailwater outflow.

Through implementation of the complete system modernization program (Phases I - IV and Levels 1 and 2), it is estimated that approximately 20 to 50 percent⁷ of existing operational spillage could be conserved annually, or between approximately 5,000 and 13,000 af per year. This conserved water could be used to:

- Increase local water supply and supply reliability,
- Increase local water delivery flexibility,
- Increase in-stream flow,
- Improve water quality, and/or
- Meet other regional and statewide water management objectives

Each phase provides varying levels of anticipated benefit with the first two phases likely seeing higher benefit than the third and fourth due to the greater number of sites improved, establishment of primary spill routing, and improvement of control structures that are located higher in the system (i.e. have control over a larger proportion of the total water diverted). The marginal estimated range of percent reduction in spillage and boundary outflow achieved by completing phases is described below:

1. Phase I: 2 to 5 percent reduction; 400 to 900 af of the targeted flow path
2. Phase II: 15 to 25 percent reduction; 2,400 to 4,500 af of the targeted flow path
3. Phase III: 2 to 10 percent reduction; 400 to 1,800 af of the targeted flow path
4. Phase IV: 2 to 10 percent reduction; 400 to 1,800 af of the targeted flow path

Net Benefit Analysis

The district is currently implementing associated EWMPs at locally cost-effective levels. SEWD has not used its full allocation in recent years, and thus would not achieve cost savings through additional conservation. The estimated implementation cost per unit of water conserved is presented in Table 7. In the table, annualized costs of the SCADA base station are distributed across phases based on the relative magnitude of annualized costs for each phase. Currently, the unit cost of conservation exceeds the potential monetary savings. As a result, further implementation of the system modernization project is not locally cost effective at this time. In the future, it is anticipated that the costs and estimated benefits of this improvement project will be evaluated as additional information becomes available.

⁷ Potential spillage reduction was based in part on information from the technical memorandum "Spillage Reduction- Monitoring and Verification" published by the Agricultural Water Management Council and partly on experience with local conditions and judgment. Reductions in tailwater can also be assumed to some degree given the improved delivery steadiness, flow measurement, and control that this project enables.

Table 7. Estimated Implementation Cost per Unit of Water Conserved.

<u>Modernization Phase</u>	<u>Annual Cost, Levels 1 and 2 (\$/yr)</u>	<u>Conserved Water Range (af/yr)</u>	<u>Conservation Cost (\$/af)</u>
Phase I - Improvement of Primary Inflow Locations and Primary Operational Outflow Locations	\$36,544	260 to 1300	\$28 to \$141
Phase II - Improvement of Main Canal Primary Control Points	\$672,424	3,900 to 6,500	\$103 to \$172
Phase III - Improvement of Lateral Primary Control Points and Spill Routing	\$180,006	520 to 2,600	\$69 to \$346
Phase IV - Improvement of Lateral Secondary Points, Sublateral Control Points and Secondary Spill Points	\$91,665	520 to 2,600	\$35 to \$176
Totals	\$980,639	5,200 to 13,000	\$75 to \$189

Project 2: Boundary Outflow, Primary Spill Measurement and Tailwater Recovery

Project Description

Two improvement packages are combined in this section (1) Boundary Flow and Primary Spill Measurement and (2) Tailwater Recovery. Both of these projects have similar objectives, as described in Table 8.

Table 8. Objectives of Boundary Outflow and Primary Spill Measurement and Tailwater Recovery Projects.

Objective	Boundary Flow and Primary Spill Measurement	Tailwater Recovery
Improve Water Use Efficiency	Measurement of operational spillage and drainage flows can be used to make better informed system adjustments that can lead to reduced spillage and possibly a reduction in total demands. Reduced spillage and reduced tailwater can lead to reduced diversions.	Reuse of operational spillage and tailwater results in decreased required diversions. Available water not diverted remains in storage and could potentially be available to meet unmet demands or for transfer.
Develop Water Use Data	Measurement of boundary outflows and primary spillage provides the data necessary to quantify surface water leaving district, better define unmeasured flows (such as deep percolation), determine areas of high loss, characterize operational efficiencies, and aid in prioritization of improvements.	
Support Reporting	Measurement of spillage, boundary flows and recovered drainwater provides information relating to water supply, water use, water quality, environmental benefits, etc. Measurement also supports the district in responding to potential inquiries from landowners regarding water supply, water use, and historical trends.	
Increase Operational Efficiency	Measurement of spillage enables operators to make corresponding adjustments at lateral headings or at the diversion to reduce spillage or total diversions. Measurement provides early detection of end canal conditions (high or low) that may be impacting delivery service.	Recovering drain water enables operators to meet demands more quickly and flexibly. Measurement will inform adjustments, maximizing drainwater extraction, minimizing diversions and minimizing spillage.

The project summaries provided in this attachment include an inventory of existing or potential sites that fall into one of the classifications described in Table 9.

Table 9. Descriptions of Site Type Classifications.

Site Type Classification	Description	Improvement Package
Boundary Inflow	Flows entering the district boundaries and providing the availability of increased supply.	Boundary Flow and Primary Spill Measurement
Boundary Outflow	Flows leaving the district boundaries and representing excess inflows, intentional releases to satisfy obligations to meet out-of-district demands, or water management issues.	Boundary Flow and Primary Spill Measurement
Internal Outflow	Flows intentionally discharged from district canals to drainage channels for downstream delivery or possible recapture (e.g. deliveries to Secondary).	Boundary Flow and Primary Spill Measurement
Internal Inflow	Additional supply entering the district from within its boundaries (e.g. groundwater wells).	Boundary Flow and Primary Spill Measurement
Internal Spill	Excesses in supply canals that are discharged to drain channels through safety spill structures.	Boundary Flow and Primary Spill Measurement
Tailwater Recovery (Pump)	Recapture of tailwater via pump as it passes through the district. Recaptured water may be spillage or tailwater from neighboring districts, or from internal sources.	Tailwater Recovery

For each selected site, conceptual designs were developed that improve the site to meet the objectives. A total of three boundary outflow locations, two boundary inflow, 13 internal spill sites, two internal inflow sites, and seven tailwater recovery sites were identified for potential improvement. The selected sites (shown in Figure 2) were identified as high priority through consultation with district personnel or identified as likely high use sites based on their position in the distribution system, such as at the end of main canals or primary laterals. Several additional spill sites were identified but not included in this improvement package because of their perceived low volume or infrequent use. Recommended improvement sites are subject to revision following refinement of prioritization criteria and more detailed review and analysis.

[This Page Intentionally Blank]

[This Page Intentionally Blank]

Recommended measurement devices for the boundary and spill flows vary by site type, site conditions and existing infrastructure or proposed infrastructure. Additionally, the intensity of use (rate and duration) relative to other sites, and the importance of the site to meeting the objectives also factor into the selection of measurement devices. In total, four measurement strategies were developed based on unique conditions. In general, it is recommended that improvement projects or phased modernization employ the same device, or a limited selection of devices, throughout the district to maintain consistency in reporting, accuracy, and operations. This also simplifies training of new employees, maintenance protocols, and troubleshooting, as well as minimizes the required spare parts. The four measurement strategies are described in Table 10.

Table 10. Descriptions of Measurement Devices and Associated Advantages and Limitations.

Measurement Device	Measurement Method	Advantages	Limitations
Acoustic Doppler Meter	Doppler technology measures water velocity. Velocity X Area = Flow rate	High accuracy depending on siting. Generally little calibration and are SCADA-Ready. No moving parts.	Requires power source. Requires a stable cross section and uniform flow velocities. Weeds or other obstructions impact accuracy.
Open Channel Propeller Meter	Flow through pipe rotates propeller. Rotational velocity is related to water velocity. Velocity X Area = Flow rate	Simple and relatively inexpensive device. Can provide good accuracy depending on siting. Effective in submerged situations. District staff is familiar with technology.	Air pockets, turbulence, weeds or other trash may cause inaccuracies. Moving parts require annual maintenance. Requires full pipe.
Sharp Crested Weir	For a given weir length, flow is determined by depth of flow over weir crest.	Simple and inexpensive device. Easily adaptable to majority of existing spill structures. Good accuracy depending on siting. Minimal maintenance required.	Accuracy limited to measurement of head on weir. Requires free fall of flow over weir and uniform velocities.
RemoteTracker ⁸	Portable device measures water velocity in pipeline. Velocity X Area = Flow rate	Portable. Highly accurate and simple operation. Incorporates remote communications and water delivery records	Subject to inaccuracies caused by air pockets or turbulence. Requires full pipe. Does not provide continuous measurement.

Measurement of drain channels often presents unique challenges not often experienced in distribution canals. These include, but are not limited to: inconsistent cross sections with heavy vegetative growth, widely fluctuating flows including storm water runoff, are not typically maintained, higher than normal trash loads, below grade, low hydraulic gradients, and may be subject to additional environmental regulations.

Tailwater recovery improvement recommendations focus on providing a reliable and flexible supply that can be monitored by the operators and manipulated when needed. The amount of tailwater recovery is limited to available drain flows, but improvements seek to maximize its use. Effective recovery sites

⁸ The RemoteTracker is a portable measurement device developed specifically as a water district delivery measurement solution in response to State of California Senate Bill x7-7. The device is currently being utilized by some Feather River water users.

require: 1) infrastructure to check-up drain flows for extraction, 2) extraction device with flexible control, 3) monitoring and measurement of extraction, and 4) infrastructure or equipment in canal to provide feedback for control logic and to pass recovered water to delivery locations.

Several of the boundary flow, spills, and tailwater recovery sites are incorporated to some degree in the system modernization project as measurement of outflows is an important component, as is reregulation and augmentation of supplies using tailwater. There are several spill sites recommended for improvement in this package that are not included in the modernization package. This is because the modernization package helps define new spill routing opportunities and consolidates multiple spill sites or eliminates the need for intermediate operational spills, other than in emergency situations.

In most cases, selected spill sites are existing sites that require only minimal improvement or slight reconfiguration; however, some require complete reconstruction or new measurement method. Boundary outflow and internal outflow sites are generally new sites, but their locations are defined at the crossing of the district boundary by the conveyance channel. These sites may require the modification of the site for flow measurement accuracy or installation of the measurement device. Tailwater recovery sites are all historical drain recovery sites that may benefit from improved operations, monitoring, or measurement.

Inventory of Existing Sites

Existing sites were identified through consultation with district operations staff and digitally inventoried in tabular form and in an interactive mapping format. For each site type, several sites were selected for field inspection to obtain dimensions, coordinates, photos and operational features typical of the site type to aid in strategy development and costing. For each site proposed for improvement, Table 11 provides the site name, the site type, latitude, longitude, and a description of the existing conditions. As previously discussed, the improvement process described here focuses on primary outflow and spill points and tailwater recovery sites and may not include all minor features.

Table 11. Inventory of Existing Sites.

Site Name	Site Type	Latitude	Longitude	Description of Existing Conditions
Snake River at Farrington Lateral	Boundary Inflow	39.2068	-121.7061	No existing measurement. Earthen channel with steep, heavily vegetated banks. A measurement site downstream from confluence with RD2056 drain will measure total inflow.
East Interceptor (Live Oak Slough Inflow)	Boundary Inflow	39.1709	-121.6956	No existing measurement. Deep, incised earthen channel with steep, heavily vegetated banks. Inflow likely small.
Weir 4	Boundary Outflow	39.1534	-121.7344	Concrete structure with several flashboard bays with boards that are manually adjusted to maintain upstream water level in Interceptor Canal.
Hwy 113 Outflow	Boundary Outflow	38.9675	-121.6726	No existing measurement. Steel channel iron attached to face of CMP culvert to form board guides. Boards are manually adjusted to maintain upstream water level. Spill flow passes through length of culvert under Levee access road before going under Hwy 113.

Site Name	Site Type	Latitude	Longitude	Description of Existing Conditions
DWR Pumping Plant #2	Boundary Outflow	39.0263	-121.7270	Water typically flows by gravity to Sutter Bypass. Flow reversal may occur. Pumps are operated to convey flood flows.
Main Canal End Spill	Internal Spill	39.0251	-121.7134	Concrete headwall with 3ft wide flashboard bay
Clements Spill	Internal Spill	39.1023	-121.7454	Concrete headwall with 3ft wide flashboard bay
Farrington Lateral End Spill	Internal Spill	39.0914	-121.7455	2ft wide weir box with flashboards
Upper Encinal Spill	Internal Spill	39.2213	-121.6616	Concrete weir box with adjustable weir boards to control water level and spill point.
Live Oak Spill	Internal Spill	39.2089	-121.6800	
Franklin Spill	Internal Spill	39.1237	-121.7223	2ft wide weir box with flashboards. Discharge piping empties to drain
A-Line Spill	Internal Spill	39.0915	-121.7268	Concrete weir box with adjustable weir boards to control water level and spill point.
C-Line Spill	Internal Spill	39.0943	-121.6837	
F Spill	Internal Spill	39.0399	-121.7180	Concrete weir box with adjustable weir boards to control water level and spill point.
E-O Spills	Internal Spill	39.0325	-121.7085	
E2 Spills	Internal Spill	39.0398	-121.6992	
F1 Spill	Internal Spill	39.0758	-121.7351	Flashboard bay side spill with adjustable boards. Discharge piping empties to drain
Frog Slough Spill	Internal Spill	39.1713	-121.7348	Single flashboard bay in concrete headwall with adjustable boards
SEWD GW Well #1	Internal Inflow	39.1708	-121.7006	Groundwater well discharges to Main Canal downstream of Peppard Pumps. Magnetic meter provides flow measurement
SEWD GW Well #2	Internal Inflow	39.1266	-121.6981	Groundwater well discharges to Main Canal downstream of the Franklin Weir.
Dettling Pump	Tailwater Recovery	39.025	-121.713	40hp pump that lifts water from the drain to Lateral E of the Main Canal.
Twin Pumps	Tailwater Recovery	39.069	-121.708	One 7.5hp pump that is no longer operational.
Shannon Pumps	Tailwater Recovery	39.062	-121.727	20hp and 80hp pumps that extract water from the State Reclamation Drain to the F Lateral. Can also deliver water to SNWR via gravity.
Vanderford Pump	Tailwater Recovery	39.083	-121.718	25hp pump in the Live Oak Canal augments supply in Lateral F.
Clements Pump	Tailwater Recovery	39.102	-121.746	Structure contains a spill from Farrington Lateral to drain, and a drain recovery pump that attempts to maintain the canal water level upstream of the 36" diameter CMP crossing that spans the drain channel

Site Name	Site Type	Latitude	Longitude	Description of Existing Conditions
Clark Pumps	Tailwater Recovery	39.171	-121.721	Three pumps (40hp, 30hp and 25hp) pump tailwater from Interceptor canal into Farrington Lateral. Pumps use Warrick Controls to maintain water levels in canal. Flume has two 2ft wide weir bays to spill to Interceptor.
Peppard Pumps	Tailwater Recovery	39.171	-121.700	75hp and 30hp drain recovery pumps. Flume is constructed of wood planks and has eight 3ft wide flashboard bays for delivery or spill to Interceptor Drain.

Boundary Outflow and Spill Measurement and Tailwater Recovery Physical and Operational Improvements

For each site, improvement is split into two levels, Level 1 and Level 2. Level 1 improvements often are infrastructure and measurement enhancements that are manually operated or read, but designed as SCADA-Ready⁹ sites. These improvements include, but not limited to: VFD-controlled pumps, automated gates, measuring weirs, acoustic Doppler meters, and propeller meters. Level 2 improvements build on the Level 1 improvements by adding electronic sensors, installing on-site digital display of flow rate or other parameters, or add remote monitoring or control through a Supervisory Control and Data Acquisition System (SCADA). Level 1 improvements are stand-alone, while Level 2 improvements generally require Level 1 to be completed prior or simultaneously. This phased implementation provides the District the flexibility to complete Level 1 (which has significant benefits on its own) while assessing the benefits of SCADA, prioritizing sites, establishing the SCADA base station and gradually implement the more complex or more expensive sites.

Although Level 2 is not universally required to be completed to obtain significant benefits, several sites will greatly benefit from it. For example, remotely located end spill sites or boundary outflow sites are not frequently visited by operators, and if they are visited and spill is noticed, it may not be worth the travel time to the heading to make a change. Remote monitoring would eliminate travel time, but does require the development of a SCADA office base station.

Additionally, in some cases, there is potentially some savings in capital costs by completing level 1 and level 2 at the same time.

Table 12 provides a description of the improvement proposed for each Boundary Flow and Primary Spill sites, the objective of the improvement and a Phase I and Phase II cost. Table 13 provides similar detail for Drain Recovery Sites. All costs are subject to revision following refinement of site improvements following more detailed review and design.

⁹ "SCADA-Ready" describes a package of hardware and/or software that communicates and operates locally but has been specifically designed and installed to readily accept a data transmission and receiving device (e.g. radio, cellular modem, etc.) and to provide remote communication with an established base station and SCADA human machine interface (HMI).

[This Page Intentionally Blank]

Table 12. Summary of Boundary Outflow and Primary Spill Measurement Improvement Sites.

Site Name	Site Type	Description of Operational Objective	Level 1 Modernization and Enhancement	Improvement Cost (\$)	Annualized Cost (\$)	Level 2 Modernization and Enhancement	Improvement Cost (\$)	Annualized Cost (\$)
Snake River at Farrington Lateral	Boundary Inflow	Measurement of boundary inflows will assist SEWD operators in day to day and seasonal adjustments, and improve water accounting within the service area. Measurement of Snake River at the Farrington Lateral would be mutually beneficial to BWD and could be a joint project.	Install ADVIM in cross section formed by Farrington flume abutments. Perform velocity index calibration of measurement site and install solar power system, digital flow display and related components. Site will be SCADA-Ready.	\$26,400	\$2,900		\$5,900	\$600
East Interceptor (Live Oak Slough Inflow)	Boundary Inflow	Measurement of boundary inflows will assist SEWD operators in day to day and seasonal adjustments, and improve water accounting within the service area. Measurements at this location will also help operators meet downstream tailwater supply obligations (in SNWR or other)	Construct control section in existing channel and install ADVIM. Perform velocity index calibration of measurement site and install solar power system, digital flow display and related components. Site will be SCADA-Ready.	\$55,400	\$5,300	Add communication hardware to measurement site and integrate with SCADA system to provide real-time monitoring of flow rate and water level	\$5,900	\$600
Weir 4	Boundary Outflow	Measurement at this location will help operators meet downstream tailwater supply obligations (in SNWR or other) and inform water accounting.	Construct control section in existing channel downstream from Weir 4 in straight section of channel and install ADVIM. Perform velocity index calibration of measurement site and install solar power system, digital flow display and related components. Site will be SCADA-Ready.	\$55,400	\$5,300		\$5,900	\$600
Hwy 113 Outflow	Boundary Outflow	Measurement at this location will inform operators and managers as to the amount of water leaving the service area. This may help to refine system set points, delivery volumes, and inform water accounting.	Install ADVIM in culvert pipe. Perform calibration of measurement site and install solar power system, digital flow display and related components. Site will be SCADA-Ready.	\$26,400	\$2,900		\$5,900	\$600
DWR Pumping Plant #2	Boundary Outflow	Allow measurement of drain flows to Sutter Bypass. Measurement will inform water accounting.	Required improvements not identified at this time.	\$0	\$0		\$0	\$0
Main Canal End Spill	Internal Spill	Provide accurate and accessible measurement of spillage flow rate from the Main Canal as feedback on heading operation, general lateral operation, and for improved District water accounting. Spillage records will help inform the modernization process.		\$8,700	\$700		\$15,400	\$1,500
Clements Spill	Internal Spill	Provide accurate and accessible measurement of spillage flow rate from the Farrington Lateral as feedback on heading operation, general lateral operation, and for improved District water accounting. Spillage records will help inform the modernization process.		\$8,700	\$700	Install pressure transducer in new stilling well upstream of spill box to measure head on weir. Perform calibration of weir. Install communication hardware and integrate with SCADA system to allow remote monitoring.	\$15,400	\$1,500
Farrington Lateral End Spill	Internal Spill			\$8,700	\$700		\$15,400	\$1,500
Upper Encinal Spill	Internal Spill			\$8,700	\$700		\$15,400	\$1,500
Live Oak Spill	Internal Spill			\$8,700	\$700		\$15,400	\$1,500
Franklin Spill	Internal Spill			\$8,700	\$700		\$15,400	\$1,500
A-Line Spill	Internal Spill			\$8,700	\$700		\$15,400	\$1,500
C-Line Spill	Internal Spill			\$8,700	\$700		\$15,400	\$1,500

Site Name	Site Type	Description of Operational Objective	Level 1 Modernization and Enhancement	Improvement Cost (\$)	Annualized Cost (\$)	Level 2 Modernization and Enhancement	Improvement Cost (\$)	Annualized Cost (\$)
F Spill	Internal Spill			\$8,700	\$700		\$15,400	\$1,500
E-O Spills	Internal Spill			\$8,700	\$700		\$15,400	\$1,500
E2 Spills	Internal Spill			\$8,700	\$700		\$15,400	\$1,500
F1 Spill	Internal Spill			\$8,700	\$700		\$15,400	\$1,500
Frog Slough Spill	Internal Spill			\$8,700	\$700		\$15,400	\$1,500
SEWD GW Well #1	Internal Inflow	Augment flow in the Main Canal when needed to meet demands, or to achieve conjunctive management objectives.	Pump discharge is currently measured with a magnetic meter. No recommended improvements.	\$0	\$0	Add communication hardware to measurement site and integrate with SCADA system to provide real-time monitoring of flow rate.	\$5,900	\$600
SEWD GW Well #2	Internal Inflow		Add magnetic meter in-line with pump discharge to measure discharge rate.	\$7,000	\$383		\$5,900	\$600

Table 13. Summary of Tailwater Recovery Improvement Sites.

Site Name	Description of Operational Objective with Improvements	Level 1 Modernization and Enhancement		Level 2 Modernization and Enhancement		Annual Cost (\$/yr)	Capital Cost (\$)	Annual Cost (\$/yr)
		Capital Cost (\$)	Annual Cost (\$/yr)	Capital Cost (\$)	Annual Cost (\$/yr)			
Detting Pump	Augment flow in the Main Canal to provide constant flow rate to downstream deliveries.	\$19,000	\$1,041	\$15,400	\$1,500		\$15,400	\$1,500
Twin Pumps	Augment flow in the E-O Lateral to provide constant flow rate to downstream deliveries.	\$31,000	\$1,698	\$15,400	\$1,500		\$15,400	\$1,500
Shannon Pumps	Augment flow in the Shannon Extension Lateral to provide constant flow rate to downstream deliveries.	\$30,000	\$1,643	\$15,400	\$1,500		\$15,400	\$1,500
Vanderford Pump	Augment flow in Lateral F to provide constant flow rate to downstream deliveries.	\$19,000	\$1,041	\$15,400	\$1,500		\$15,400	\$1,500
Clements Pump	Re-regulate flow in the Farrington Lateral to provide constant flow rate to downstream deliveries. Excesses in supply are spilled to Little Blue Creek instead of being passed downstream, and deficiencies are met by extracting tailwater.	\$33,600	\$1,840	\$15,400	\$1,500		\$15,400	\$1,500
Clark Pumps	Re-regulate flow in the Farrington Lateral to provide constant flow rate to downstream deliveries. Excesses in supply are spilled to Interceptor Drain instead of being passed downstream, and deficiencies are met by extracting tailwater.	\$30,000	\$1,643	\$15,400	\$1,500		\$15,400	\$1,500
Peppard Pumps	Re-regulate flow in the Main Canal to provide constant flow rate to downstream deliveries. Excesses in supply are spilled to Interceptor Drain instead of being passed downstream, and deficiencies are met by extracting tailwater.	\$30,000	\$1,643	\$15,400	\$1,500		\$15,400	\$1,500

[This Page Intentionally Blank]

Project Costs

Costs for the Boundary Outflow and Primary Spill Measurement Project

Reconnaissance level cost estimates were prepared for both improvement packages described in the preceding sections as a basis for prioritization and funding of site improvements. For the Boundary Flow and Primary Spill Measurement package, the total combined cost (Level 1 and Level 2) of improvement is approximately \$519,000, with estimated annualized costs of \$49,000. Total costs are further summarized in Table 14.

Table 14. Summary of Costs.

<u>Boundary Flow and Primary Spill Measurement</u>	<u>Level 1</u>		<u>Level 2</u>	
	<u>Capital Costs (\$)</u>	<u>Annual Costs (\$)</u>	<u>Capital Costs (\$)</u>	<u>Annual Costs (\$)</u>
Boundary Flows Subtotal	\$170,600	\$16,783	\$35,400	\$3,600
Spills Subtotal	\$113,100	\$9,100	\$200,200	\$19,500
Total Cost =	\$283,700	\$25,883	\$235,600	\$23,100

Costs for the Tailwater Recovery Project

The total cost of improving or developing the seven drain recovery sites is approximately \$313,000, with estimated annualized costs of \$22,000. Total costs are further summarized in Table 15.

Table 15. Summary of Costs.

<u>Tailwater Recovery</u>	<u>Level 1</u>		<u>Level 2</u>	
	<u>Capital Costs (\$)</u>	<u>Annual Costs (\$)</u>	<u>Capital Costs (\$)</u>	<u>Annual Costs (\$)</u>
Total Cost (Seven Sites) =	\$199,600	\$10,933	\$113,700	\$11,100

The aforementioned costs do not include a SCADA base station (which would be required for Modernization Phase II) or any mobile operator terminals that would form the backbone of the District SCADA system, or any costs of spare equipment to be kept on hand to repair or replace individual site components due to theft, vandalism, or other failure. These costs are summarized in Table 16. This cost represents a robust SCADA network that would be capable of monitoring the identified measurement and drain recovery sites as well as existing or future sites, such as detailed in the Modernization program. The cost of the office base station may be drastically reduced, or eliminated, if the District is able to 'piggy-back' on to and expand the existing SCADA network owned and operated by the Joint Water Districts and Joint Board.

Table 16. Summary of Costs for SCADA Office Base Station and Spare Parts.

<u>Item</u>	<u>Capital Cost (\$)</u>	<u>Annual Cost (\$)</u>
SCADA Office Base Station	\$138,063	\$17,039
Spare Parts	\$23,692	\$2,913

Potential Benefits

Flow paths targeted under the boundary flow and primary spill measurement and tailwater recovery projects include:

- Drainage Outflows
- Operational Spillage
- Deliveries
- Tailwater

Measurement of boundary flows and spills provides operators the tools to reduce operational losses. Reduction in losses may result in decreased required diversions. Reuse of operational spillage and tailwater results in decreased required diversions. Available water not diverted remains in storage and can increase supply reliability in shortage years or could potentially be available for transfer.

Available water not diverted remains in storage and can increase supply reliability in shortage years or could potentially be available for transfer. Through implementation of these projects, it is estimated that approximately 5 to 15 percent¹⁰ of existing irrigation season boundary outflows could be conserved annually, or between approximately 4,000 and 11,000 af per year depending on the level of implementation.

Net Benefit Analysis

The district is currently implementing associated EWMPs at locally cost-effective levels. SEWD has not used its full allocation in recent years, and thus would not achieve cost savings through additional conservation. The estimated implementation cost per unit of water conserved ranges from approximately \$9 to \$26 per acre-foot. As a result, further implementation of the boundary outflow and primary spill measurement and tailwater recovery project is not locally cost effective at this time. In the future, it is anticipated that the costs and estimated benefits of this improvement project will be evaluated as additional information becomes available.

¹⁰ Based in part on percent reductions in spillage for various improvement measured listed in the technical memorandum "Spillage Reduction- Monitoring and Verification" published by the Agricultural Water Management Council, and partly on experience with local conditions and judgment.

Project 3: Removal of Main Canal Bottlenecks

Project Description

The Main Canal downstream of the Sunset Pumps has five bottlenecks that limit capacity at structures: the Highway 99 and Railroad Crossing; the abandoned railroad culverts; the Clark Road Culvert; the Broadway Road Culvert, and a private drive crossing just upstream from Highway 20. The objective of this improvement project is to reconstruct these sites with increased capacity.

For each site, conceptual designs developed as part of the Sutter Butte Regional Conveyance Study¹¹ were evaluated to ensure consistency with the objectives and costs were updated to reflect normal inflation of construction costs and to account for prevailing wage rates likely to be required if external funding were secured for implementation. Two additional bottlenecks were identified along the Sutter-Butte Canal, but these are within the boundaries of BWD and are discussed in a separate attachment.

Inventory of Existing Sites

Existing sites were identified through consultation with district staff. Each site was visually inspected to obtain coordinates, photos and operational features to aid in strategy development and evaluation of costing.

Physical and Operational Improvements

Table 17 provides a description of the existing site condition and the improvement proposed for each of the five bottleneck removal sites. All costs are subject to revision following refinement of site improvements following more detailed review and design.

¹¹ GEI Consultants, 2006. Regional Conveyance System Improvement Project – Final Report, May 2006. Completed for Sutter Extension Water District by Bookman-Edmonston, a division of GEI Consultants, Inc.

Table 17. Summary of Improvements for Bottleneck Removal.

Site Name	Latitude	Longitude	Description of Existing Conditions	Description of Improvements and Operational Objective	Capital Cost (\$)	Annual Cost (\$/yr)
Highway 99 & Railroad	39.2402	-121.6485	Three circular concrete culverts	Replace existing crossing to increase capacity to meet downstream demands. Realign the existing channel to improve hydraulics.	\$3,182,900	\$174,400
Abandoned RR Culverts	39.2400	-121.6618	Two circular concrete culverts	Replace existing crossing to increase capacity to meet downstream demands.	\$57,900	\$3,200
Clark Road Culverts	39.2327	-121.6694	Two box culverts; flared wing walls; concrete bottom		\$410,400	\$22,500
Broadway Road Culverts	39.2251	-121.6786	Two circular concrete culverts; ~2.5ft drop at inlet; square edge with headwall		\$417,400	\$22,900
Private Drive Crossing (1/2 mi N of Hwy 20)	39.1489	-121.6983	Two box culverts; flared wing walls; concrete bottom		\$159,600	\$8,800

Project Costs

Reconnaissance level cost estimates were prepared for the improvement projects described in the preceding sections as a basis for prioritization and funding of site improvements. The total combined cost of improvement is approximately \$4,604,000 with estimated annualized costs of \$252,000. Individual site costs are summarized in Table 18.

Table 18. Summary of Costs.

<u>Bottleneck Removal</u>	<u>Capital Costs (\$)</u>	<u>Annual Costs (\$)</u>
Highway 99 & Railroad Crossing	\$3,183,000	\$174,000
Abandoned RR Culverts	\$58,000	\$3,200
Clark Road Culverts	\$411,000	\$23,000
Broadway Road Culvert	\$418,000	\$23,000
Private Drive Crossing	\$160,000	\$9,000
Total Cost =	\$4,603,500	\$252,400

Potential Benefits

The removal of the five identified bottlenecks has no water conservation benefits that could be reasonably quantified at this stage of design. However, several qualitative benefits to SEWD include:

- Increased ability to meet refuge and other water user demands (limited to downstream canal capacity constraints).
- Increased capacity to meet downstream irrigation demand (limited to downstream canal capacity constraints) may enable increased rotational frequency or larger available irrigation heads. This may increase irrigation efficiency.
- Potential for avoided labor required to make frequent gate adjustments.
- Increased safety and structural adequacy of structures.

Net Benefit Analysis

A net benefit analysis was not performed for this project because the improvements are not consistent with an identified EWMP.

Project 4: Alternatives for Improving Delivery Service to Pressurized Irrigation Systems

Project Description

Sutter Extension Water District is similar to the primary Feather River water users (WCWD, RID, BWGWD) in that its irrigated acreage is dominated by rice (approximately 80% of SEWD). Because of this, infrastructure and operational strategies were historically developed to provide service to rice fields and have been adapted accordingly. However, SEWD also contains approximately 3,000 acres (14% of total irrigated area) of permanent orchards concentrated on the eastern side of the district.

Historically, many orchard crops were flood irrigated and operators were able to sufficiently manage these deliveries with deliveries to rice ground. However, the ability to provide flexible irrigation service to orchards has become increasingly difficult as many orchard growers convert from flood irrigation to micro-irrigation (drip, or micro-sprayers) to take advantage of various agronomic, labor, water conservation, or economic benefits. Micro-irrigation requires very different irrigation delivery rates, frequencies, and durations, (when compared to rice) which are difficult to impossible to provide concurrently while still maintaining a moderate level of system efficiency. Micro-irrigation methods typically require a small flow rate for a long duration and at a high frequency which is inconsistent with the irrigation scheduling and methods that are used for rice.

Providing this level of flexibility is difficult and puts additional strain on the system and its operators. In some cases, this has adversely affected service and has caused an increasing number of orchard growers to switch from surface water to groundwater which can be more flexible and typically requires less filtration than district supplied water. The use of district water typically requires two types of filtration for micro irrigation systems: a course filter to remove large debris, and a fine filter to remove smaller particles. The filters must be routinely flushed to remove debris, requiring additional water and requiring infrastructure to collect or convey debris.

In general, the objective of this improvement project is to identify opportunities to provide flexible deliveries at a frequency, rate and duration that will incentivize growers to utilize surface water over groundwater.

Some of the larger canals in the district that remain full for the entire season can be better suited to meet the frequency, rate and duration requirements of micro-irrigation, but likely still fall short in filtration and water quality. In general, canals that serve permanent crops are subjected to common difficulties with providing flexible service to pumped deliveries, as listed below:

1. Long durations and small flow rates require supply canals to remain filled for a longer period when compared to a rotational system. This increases losses and requires a small maintenance flow which is difficult if canal control is limited.
2. High frequency, long duration and small flow rate deliveries inevitably lead to many simultaneous deliveries that require a large portion of the system (if not all) to be filled throughout the irrigation season.
3. Pumped deliveries require a constant supply to prevent pump damage. This is nearly impossible to supply in an open canal system without storage or supplying extra water to the lateral to ensure the pump doesn't run dry. The latter typically leads to spillage.

4. Power failures, mechanical failures or other unannounced shutoffs cause fluctuations in water levels requiring intensely vigilant operators or result in spillage.
5. Water ordering is difficult in an open system with pump deliveries because uncertainties in rotation, duration, demand rate, etc. are high. This often leads to excess water being ordered and spilled if not used.

Based on a field tour of the district, observation of irrigation systems, field layouts, delivery gates, and conveyance infrastructure, several improvement alternatives were identified that have the potential to improve service to pressurized irrigators. These are listed below in no particular order:

1. Construction of regulating storage within in the system to enable flexible service while minimizing spillage.
2. Construction of intertie pipelines between adjacent laterals to increase the downstream demand area available for use of spill or excess water supplied to prevent pump damage.
3. Convert laterals with concentrate pressurized irrigation to buried, mechanically pressurized supply pipeline and delivery network.
4. Construct group turnouts in areas with high concentration of pump deliveries to minimize labor requirements.
5. Construct on-channel pumping sumps to accommodate on-farm pressurized irrigation systems and minimize filtration requirements.
6. Install manual filtration screens (course filtration) at the heading of each lateral.
7. Install manual filtration screens (semi course filtration) at each pressurized turnout.
8. Install automated filtration screens (semi fine filtration) at the heading of each lateral.
9. Install automated filtration screens (semi fine to fine filtration) at each pressurized turnout.
10. Develop construction and technical standards for growers interested in connecting to the District system. This will standardize turnouts and provide the opportunity to add flow measurement and possibly remote monitoring to each pump to provide operators with real-time information on pump status and pumping requirement.

Although Alternatives 1, 2, and 3 above are predictable methods for increasing flexibility (among other benefits), a high level review did not identify any sites in SEWD with anticipated potential benefits significant enough to justify further analysis. The remaining alternatives can be generally packaged into two categories: Improvement of Turnout Configurations, and Debris Management. The physical or operational components associated with each of these categories, or packages, are described in additional detail in subsequent sections.

Physical and Operational Improvements

Improved Turnout Configuration

The improved turnout configuration package includes two alternatives for improved infrastructure, and a description of a standardization process that could be implemented by the district to facilitate adoption of formal rules regarding the supply of on-farm pressurized irrigation systems, as well as enable some enforcement and control over the connection details which, in the end, will likely enable enhanced delivery service.

A conceptual design for improved turnout specifically for on-farm pressurized irrigation systems would include a rectangular concrete structure with one open side integrated into the side of a supply canal

such that the pump intake is located out of the channel (minimizing canal flow restriction), but has an ample supply of water (assuming the canal stays full), and any debris can be manually or automatically cleaned from the intake screen and swept downstream. This alternative simplifies district operational effort and provides increased flexibility and cost savings potential (due to reduced filtration requirements) for the grower. Figure 3 provides an example of the described turnout configuration that has been implemented in the Orland Water Users Association.



Figure 3. Alternative turnout structure to allow direct pumping from district canal to supply an on-farm pressurized irrigation system. During and following construction.

The construction of group turnouts along laterals with high concentration of on-farm pressurized systems would require the reconfiguration of certain reaches of canal into essentially level-top pools. This provides limited storage in the vicinity of turnouts, reduces the effects of upstream or downstream

fluctuations and maintains a constant water level for more efficient pumping. Additionally, one level-top pool is generally simpler to operate than several individual turnout locations.

Debris Management

Screening debris at strategic locations in the district laterals would provide several advantages to overall operations and to system efficiency. Although cleaning screens throughout the season would potentially require additional staff time, significant time, effort, and expenses could be saved by preventing canal overtopping, structures washing out, and expensive canal cleaning operations while providing improved service to customers. Specific sites have not been identified for SEWD, but likely locations are the head of primary laterals and at the upstream ends of siphons or road crossing. Optimally, screens would be located and positioned so that it prevent debris from entering the channel, but allows the sweeping velocity to pass the debris downstream.

Simple bar screens with manual cleaning are likely the most cost effective and justifiable option for the majority of locations in the system; however, a mechanical chain screen that is self-cleaning may be preferable for areas with high debris load or sensitive pump intakes. A screen that physically extracts the debris is advisable at sites where there is no sweeping flow that could move debris downstream (e.g. at a dead end lateral). For turnout filtration, sloping punch plate screens provide semi-fine filtration and have a smooth surface that allows debris to more easily be swept downstream. Automatic turnout screens that mount to the pump intake piping provide fine filtration and are self-cleaning typically using a combination of a rotating screen and a water nozzle.

The installation of manual trash screens requires regular (i.e. daily) inspection by the operator and the removal of accumulated trash as necessary. This could likely easily be incorporated into daily operations. Screens would be designed with bars sloping downstream so the velocity of the passing water pushes floating debris to the upper portions of the screen (above the water surface) thereby minimizing flow restrictions. This also makes them easier to clean.

In addition to the three improvement categories described above, the replacement of heading structures, water level control structures, and spill structures would improve operations, enabling steadier deliveries, more rapid passage of flow fluctuations to meet demands, and monitoring to inform changes and notification of issues (though SCADA implementation). These outcomes would likely increase the level of service provide to pressurized deliveries. The System Modernization Program provides additional descriptive information, site specific improvements, and related costs.

Project Costs

Reconnaissance level cost estimates were prepared for each of the three improvement categories and the alternatives in each. The costs (Table 19) serve as a basis for prioritization and funding of site improvements. Individual projects costs are provide as unit values in some cases to enable costs to be estimated for sites with varying requirements. Annual costs for the conversion to pressurized laterals include estimations of required energy costs.

Table 19. Summary of Costs.

Improvement	Estimated Total Cost (\$)	Annual Costs (\$)	Unit
Improved Turnout Configuration			
Development of Standardized Turnout Design and Technical Specifications =	\$5,000	\$274	LS
Design and Construction of On-Channel Pump Sump (includes self-cleaning screen) =	\$13,600	\$745	LS
Debris Management			
Sloped Vertical Bar Screen =	\$45		per SF
Automatic Rotating Chain Screen =	\$1,100		per SF
Sloped Punch Plate Screen =	\$30		per SF
Self-Cleaning Intake Screen (12" diameter) =	\$4,000		EA

Potential Benefits

The primary quantifiable benefit to the district with this improvement project is retaining customers and maintaining a constant revenue stream (from water sales) that covers operations and maintenance costs.

In addition to maintaining a constant revenue stream required to maintain the system, SEWD is active in the management of the local groundwater basin and recognizes the benefits of conjunctive use of available water supplies and encourages the use of surface water to maintain a net positive recharge of the aquifer.

Lateral pressurization offers additional unique benefits, including:

- Potential for improved air quality due to centralized pumping and reduction of inefficient on-farm units.
- Potential for water conservation due to the incentive to convert to more efficient irrigation methods.
- Potential for increased crop yields to improved water management.
- Potential reductions in on-farm operations costs associated with irrigation, filtration, and power costs.

Net Benefit Analysis

A net benefit analysis was not performed for this project because the district is already implementing this EWMP at a locally cost-effective level. In the future, it is anticipated that the costs and estimated benefits of this improvement project will be evaluated as additional information becomes available.

Appendix 7-D
Butte County: Evaluation of Restoration and Recharge
Within the Butte County Groundwater Basins, 2018

This page intentionally left blank.



Consulting
Engineers and
Scientists

Butte County Evaluation of Restoration and Recharge Within the Butte County Groundwater Basins

January 2018

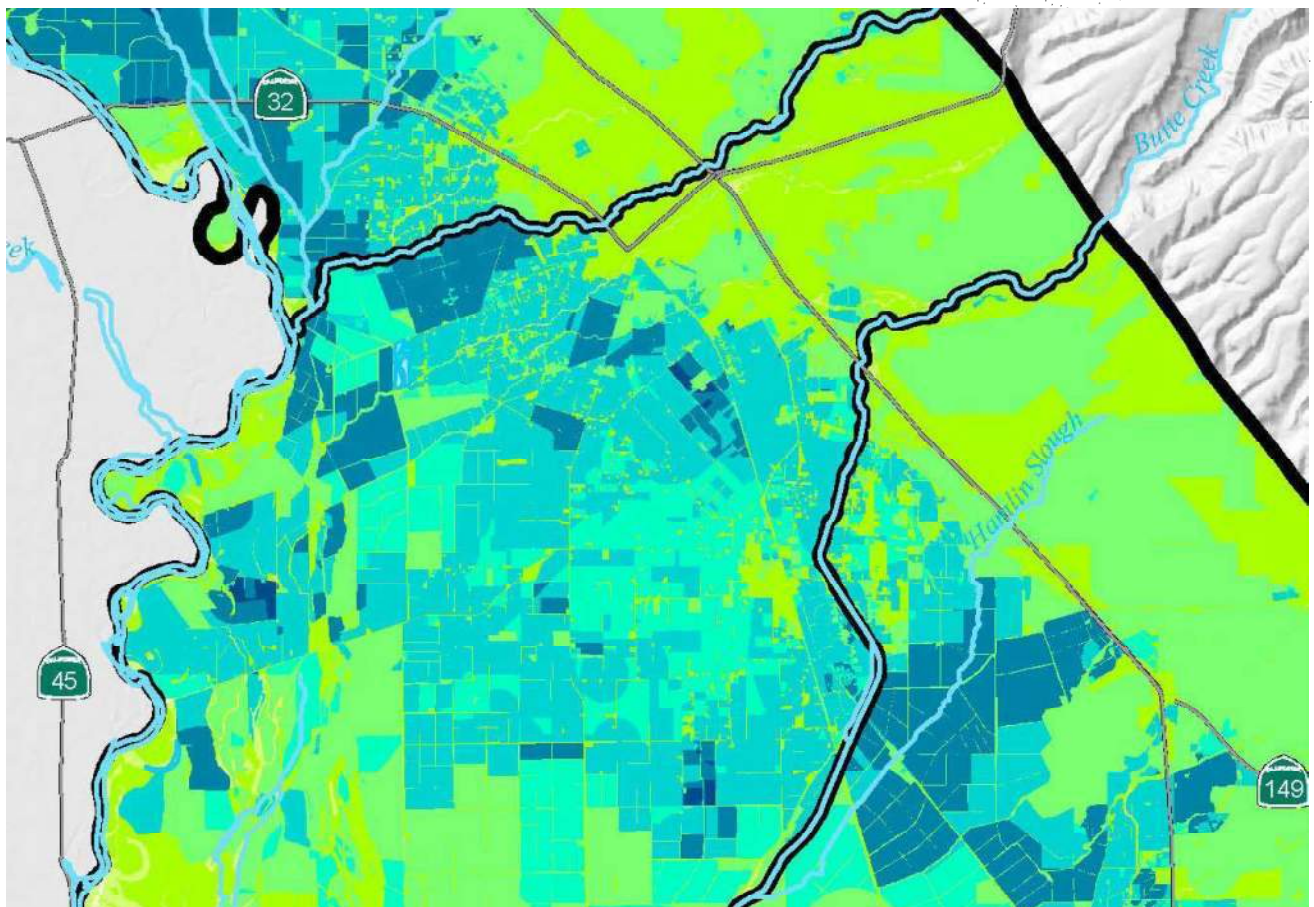

Prepared by
GEI Consultants, Inc.

In association with
Davids Engineering, Inc.
ERA Economics
Land IQ

Acknowledgements

We wish to thank the contributions of our Local Experts Group for their insights and thoughtful input to the groundwater restoration and recharge evaluation process – the results of this study are made more relevant and grounded from their efforts.

Local Experts Group

- Pete Bonacich, CalWater, Chico
- Erik Gustafson, City of Chico
- Kyle Morgado, South Feather Water and Power
- Rath Mosley, South Feather Water and Power
- Mark Orme, Butte Water District
- Sarah Reynolds, Butte County Resource Conservation District
- Danny Robinson, Gorrill Ranch/WCWD
- Debbie Spangler, DWR Northern Region
- Ron Stilwell, North State Pump
- Les Heringer, M&T Ranch
- Rich McGowan, Farmer
- Ed McLaughlin, Farmer

Butte County Department of Water and Resource Conservation

- Paul Gosselin, Director
- Vickie Newlin, Assistant Director (retired)
- Christina Buck, Assistant Director

Consultant Team

- Mark S. Williamson, David Miller, Sarah Troedson, Ryan Alward – GEI Consultants
 - Byron Clark – Davids Engineering
 - Duncan MacEwan – ERA Economics
 - Joel Kimmelshue, Stephanie Tillman – Land IQ
-

Evaluation of Restoration and Recharge Within the Butte County Groundwater Basins

Contents

Acknowledgements.....	1
Tables	4
Figures.....	4
List of Acronyms	6
1. EXECUTIVE SUMMARY	1-1
2. INTRODUCTION	2-1
2.1. Background.....	2-1
2.2. Geographic Scope	2-2
2.3. Goals and Objectives	2-5
3. RECHARGE CONSTRAINTS ANALYSIS.....	3-1
3.1. Overview.....	3-1
3.2. Land Use	3-2
3.2.1. Existing use and land value.....	3-3
3.2.2. Existing water use.....	3-6
3.2.3. Crop type and consumptive use	3-8
3.2.4. Parcel size	3-10
3.3. Aquifer Properties.....	3-12
3.3.1. Geology and soil properties	3-12
3.3.2. Depth to water and available aquifer volume	3-14
3.3.3. Well Log Review	3-15
3.3.4. Geology.....	3-15
3.3.5. Hydrogeology	3-17
3.3.6. Groundwater Levels.....	3-23
3.3.7. Groundwater Quality	3-30
3.4. Proximity to Conveyances	3-33
3.5. Sensitive Species.....	3-33
4. RECHARGE CONSTRAINTS MODELS	4-1
4.1. Recharge Methods and their Advantages and Disadvantages	4-1
4.1.1. Direct Recharge – Spreading Basins.....	4-1
4.1.2. Direct Recharge – Aquifer Storage and Recovery.....	4-2
4.1.3. Indirect Recharge (In-Lieu Recharge)	4-3
4.2. Weighting Criteria	4-4
4.2.1. Agricultural Water Supply.....	4-4
4.2.2. Land Use Type.....	4-4
4.2.3. Crop ET.....	4-5
4.2.4. SAGBI Mod Soil Data.....	4-5

4.2.5.	Soils and Geology	4-5
4.2.6.	Groundwater Gradient	4-5
4.2.7.	Proximity to Existing Conveyance	4-5
4.2.8.	Minimum Parcel Size.....	4-5
4.2.9.	Endangered Species	4-6
4.3.	Constraints Mapping.....	4-6
4.3.1.	Recharge Factor Weighting	4-7
4.3.2.	Rankings of Recharge Type.....	4-7
4.4.	Creating Constraints Maps.....	4-7
5.	IDENTIFIED RECHARGE PROJECTS.....	5-1
5.1.	Approach.....	5-1
5.2.	Water Sources for Recharge	5-1
5.2.1.	Contracted Water	5-1
5.2.2.	Natural Flow in Local Waterways	5-2
5.2.3.	Water Distributed through Irrigation Facilities.....	5-3
5.2.4.	Pumping from the Sacramento River.....	5-4
5.3.	Project Alternatives.....	5-4
5.3.1.	Alternative 1: Bi-directional Conveyance from Oroville	5-4
5.3.2.	Alternative 2: South to North Conveyance from Oroville.....	5-6
5.3.3.	Alternative 3: Construction of Recharge Basins.....	5-7
5.3.4.	Alternative 4: Sacramento River Diversions	5-7
5.3.5.	Alternative 5: Cherokee Canal Alternatives	5-8
5.3.6.	Alternative 6: Other Project and Program Options.....	5-9
5.3.7.	DeSabra-Centerville Project.....	5-11
5.4.	Recommendations.....	5-11
5.4.1.	Oro-Chico Conduit Alternatives.....	5-11
5.4.2.	Oro-Chico Pipeline Alternative	5-12
5.4.3.	Construction of Recharge Basins.....	5-12
5.4.4.	Diversions from the Sacramento River.....	5-12
5.4.5.	Opportunistic Projects.....	5-13
5.4.6.	Recharge Programs	5-13
6.	ECONOMIC EVALUATION OF IN-LIEU GROUNDWATER RECHARGE.....	6-1
6.1.	Background.....	6-1
6.2.	Characterization of Dual Source Irrigation Systems	6-2
6.2.1.	Overview.....	6-2
6.2.2.	Selected Systems.....	6-3
6.2.3.	Development of General Cost Estimates and Cost Estimation Tool	6-8
6.3.	Agronomic Assessment	6-28
6.3.1.	Overview.....	6-28
6.3.2.	Flexibility.....	6-28
6.3.3.	Disease Risk.....	6-29
6.3.4.	Water Quality.....	6-29
6.3.5.	Grower Familiarity, Perceptions, and the Need for Training	6-31
6.4.	Economic Analysis	6-31

6.4.1.	Overview.....	6-31
6.4.2.	Summary of In-Lieu Program Benefits and Costs.....	6-32
6.4.3.	Methodology.....	6-33
6.4.4.	In-Lieu Program Benefit-Cost Analysis.....	6-34
6.5.	In-Lieu Program Economic Feasibility.....	6-43
6.5.1.	Sensitivity Analysis.....	6-43
6.6.	Summary.....	6-46
6.6.1.	Key Assumptions.....	6-46
7.	ATTACHMENT A: ASSESSMENT OF AGRONOMIC FACTORS RELATED TO WATER SOURCE, IRRIGATION SYSTEM TYPE, AND DUAL SOURCE SYSTEMS.....	7-1
7.1.	Overview.....	7-1
7.2.	Agronomic Factors and Economic Considerations.....	7-1
7.3.	Factors in Choosing Groundwater or Surface Water.....	7-2
7.3.1.	Cost.....	7-2
7.3.2.	Disease.....	7-2
7.3.3.	Fertilizer Management.....	7-3
7.3.4.	Groundwater Regulation and Benefit to Groundwater Levels.....	7-3
7.3.5.	Irrigation District Infrastructure, Water Accessibility and Fees.....	7-4
7.3.6.	Irrigation Scheduling, Flexibility and Convenience.....	7-5
7.3.7.	Water Quality.....	7-5
7.3.8.	Summary.....	7-7
7.4.	Factors in Choosing Pressurized Irrigation Systems or Non-Pressurized Irrigation Systems.....	7-8
7.4.1.	Cost of Installation, Maintenance and Operation.....	7-10
7.4.2.	Fertilization Practices.....	7-10
7.4.3.	Irrigation Efficiency, Application Efficiency, and Distribution Uniformity.....	7-11
7.4.4.	Labor Requirements.....	7-12
7.4.5.	Agronomic Considerations.....	7-13
7.4.6.	Summary.....	7-13
7.5.	Factors Influencing Grower Decisions to Consider Dual-Source Irrigation Systems.....	7-14
7.5.1.	Grower Familiarity, Perceptions and the Need for Training.....	7-14
7.5.2.	Management Practices.....	7-15
7.5.3.	Longevity of Orchards.....	7-16
7.5.4.	Summary of Findings Relative to Agronomic Potential for Dual-source Irrigation Systems.....	7-16
7.6.	References.....	7-17

Tables

Table 3-1 Summary of Considerations for Each Recharge Type	3-2
Table 3-2 Average Crop ET Values for 2000 - 2015.....	3-10
Table 3-3. Mapped Species from California Natural Diversity Database	3-36
Table 4-1. Summary of Weighting Criteria	4-6
Table 6-1 Summary of Components at Each Pump and Filter Station.....	6-5
Table 6-2 Summary of 250-Acre Orchard Irrigation System	6-6
Table 6-3 Estimated Annual Costs and Cost Differences for Components of Single and Dual Source Systems: Example 250-Acre Walnut Orchard.....	6-8
Table 6-4 Dual Source System Component Unit Costs.....	6-17
Table 6-5 Dual Source System Component Useful Lives and Annual Maintenance.....	6-18
Table 6-6 Dual Source System Cost Estimation Tool Parameters	6-19
Table 6-7 Cost Estimation Tool Results for Default 100-Acre Walnut Orchard	6-22
Table 6-8 Cost Estimation Tool Results for Example 320-Acre Rice Farm	6-25
Table 6-9 Dual System and In-Lieu Program Cost Components	6-35
Table 6-10 Potential In-Lieu Program Costs	6-37
Table 6-11 Potential In-Lieu Program Avoided Fallowing Costs	6-38
Table 6-12 In-Lieu Program Stabilization Benefits.....	6-40
Table 6-13 Potential In-Lieu Program Benefit-Cost Summary	6-43
Table 6-14 Potential In-Lieu Program Sensitivity Analysis Summary	6-44
Table 6-15 Potential In-Lieu Program Benefit-Cost Sensitivity Analysis.....	6-44
Table 6-16 Potential In-Lieu Program Water Purchase Cost Sensitivity Analysis	6-45

Figures

Figure 2-1 Butte County and Alluvial Groundwater Basins.....	2-3
Figure 2-2 Project Area.....	2-4
Figure 3-1 Land Use	3-4
Figure 3-2 Land Cover.....	3-5
Figure 3-3 Water Source for Agricultural Land	3-7
Figure 3-4 ET Zones for California	3-9
Figure 3-5 Parcel Size.....	3-11
Figure 3-6 Soils by SAGBI rating group	3-13
Figure 3-7 Geology	3-16
Figure 3-8. Cross-Section Location Map.....	3-18
Figure 3-9. Cross-Section A-A'	3-20
Figure 3-10. Cross-Section B-B'.....	3-22
Figure 3-11. Cross-Section C-C'.....	3-23
Figure 3-12 Monitoring Wells with Hydrographs and Infiltration Sites	3-24
Figure 3-13 Water Level Hydrographs in Nested Well near Thermalito Afterbay	3-25
Figure 3-14 Water Level Hydrographs in Nested Well 21N1W-13J	3-25
Figure 3-15 Water Level Hydrographs in Nested Well 21N1E-13L.....	3-26
Figure 3-16 Water Level Hydrographs in Nested Well 23N1W-3H.....	3-26
Figure 3-17. Shallow Well Groundwater Elevation Contours, Fall 2015.....	3-28
Figure 3-18. Shallow Well Groundwater Elevation Contours, Spring 2016	3-29

Figure 3-19. Deep Well Groundwater Elevation Contours, Fall 2015	3-31
Figure 3-20. Deep Well Groundwater Elevation Contours, Spring 2016.....	3-32
Figure 3-21 Proximity to Existing Conveyances	3-34
Figure 3-22 Sensitive Species.....	3-35
Figure 4-1 Recharge Pond Constraints Mapping.....	4-8
Figure 4-2 Field Flooding Constraints Mapping	4-9
Figure 4-3 Groundwater Injection Constraints Mapping.....	4-10
Figure 4-4 In-Lieu Recharge Constraints Mapping.....	4-11
Figure 5-1 Potential Projects.....	5-15
Figure 6-1 Young Walnut Trees at 250-Acre Orchard	6-4
Figure 6-2 Station 1 Groundwater Well for 250-Acre Orchard.....	6-4
Figure 6-3 Layout of 250-Acre Walnut Orchard with Dual Source System	6-5
Figure 6-4 Canal Turnout Gate without Trash Rack or Screen	6-10
Figure 6-5 Canal Turnout Gate with Trash Rack.....	6-10
Figure 6-6 Dual Source System with Self-Cleaning Rotating Screen Filter to Pump Directly from Canal	6-11
Figure 6-7 Rotating, Self-Cleaning Screen Filter Followed by Centrifugal Pressure Pump and Horizontal Screen Filter for Almond Irrigation	6-12
Figure 6-8 “Can” Type Sump and Vertical Turbine Pressure Pump Used to Pressurize Surface Water.....	6-13
Figure 6-9 Rotating, Self-Cleaning Screen Filter Followed by Vertical Turbine Pressure Pump and Horizontal Screen Filter for Almond Irrigation. Screen Filter Installed Downstream of Combined Discharges of Pressure Pump and Groundwater Well	6-14
Figure 6-10 Self-Cleaning Mechanical Screen (Downstream of Turnout with Trash Rack), Centrifugal Pressure Pump, and Media Filters for Almond Irrigation with Microspray.....	6-15
Figure 6-11 Vertical Rectangular Screen Protecting Vertical Turbine Pressure Pump, Followed by Disc Filters for Prune Irrigation with Microspray	6-15
Figure 6-12 Estimated Difference in Operating Costs for Example 100-Acre Walnut Orchard with Surface Water Costs of \$5/af to \$75/af and Static Depth to Groundwater of 10 ft to 100 ft 6- 23	
Figure 6-13 Estimated Net Annual Cost of Dual Source System for Example 100-Acre Walnut Orchard with Surface Water Costs of \$5/af to \$75/af and Static Depth to Groundwater of 10 ft to 100ft.....	6-24
Figure 6-14 Estimated Difference in Operating Costs for Example 320-Acre Rice Farm with Surface Water Costs of \$5/af to \$75/af and Static Depth to Groundwater of 10 ft to 100 ft.....	6-27
Figure 6-15 Estimated Net Annual Cost of Dual Source System for Example 320-Acre Rice Field with Surface Water Costs of \$5/af to \$75/af and Static Depth to Groundwater of 10 ft to 100 ft.....	6-27
Figure 6-16 Dual System Marginal Cost by Butte County Subbasin	6-36
Figure 6-17 Normalized Sacramento River Water Supply Index (Department of Water Resources).....	6-41
Figure 6-18 Water Risk Offset Value Revenue Function.....	6-42

List of Acronyms

af	acre-feet (volume)
af/d	acre-feet per day (flow rate)
af/y	acre-feet per year (flow rate)
ASR	Aquifer Storage and Recovery (injection) recharge
bgs	below ground surface
CASGEM	California Statewide Groundwater Elevation Monitoring Program
CNDDDB	California Natural Diversity Database
cfs	cubic feet per second (flow rate)
DBCP	Dibromo-chloropropane, a soil fumigant
ET, ET _o	evapotranspiration, reference evapotranspiration
gpm	gallons per minute (flow rate)
GSP	Groundwater Sustainability Plan
ITRC	Irrigation Training and Research Center at Cal Poly San Luis Obispo
mgd	million gallons per day (flow rate)
SAGBI	Soil Agricultural Groundwater Banking Index
SGMA	Sustainable Groundwater Management Act
SWP	State Water Project

6. ECONOMIC EVALUATION OF IN-LIEU GROUNDWATER RECHARGE

6.1. Background

The economic value of groundwater has been brought into focus by ongoing drought conditions, looming sustainable groundwater management requirements under SGMA, and increased plantings of permanent crops accompanied in many cases by conversion to pressurized irrigation systems supplied by groundwater. The ability to manage the groundwater resource through in-lieu recharge – or other approaches – provides significant economic benefits to the individual grower and all other users in the basin. An economic assessment of a selected “dual” on-farm irrigation system with the capability of using either surface water or groundwater for irrigation has been completed to evaluate associated costs, benefits to the grower, and benefits accruing to others in the basin. Information gained through the analysis of this and other dual source systems has been further leveraged to more broadly evaluate potential costs and benefits of in-lieu recharge throughout Butte County.

As noted above, for a variety of agronomic and economic reasons, many permanent crop growers have converted from surface irrigation systems to pressurized sprinkler, microspray, or drip systems over time. Pressurized systems require a supply source flexible in the timing, rate, and duration of use to maximize crop production. Additional advantages of these systems include the ability to precisely apply fertilizers and other agrochemicals and better access to orchards for harvest and other cultural practices. In addition to providing flexibility advantages during the primary growing season, the availability of groundwater as a supply source for pressurized systems allows for irrigation and frost protection during periods of the year when surface water may not be available in surface water supplier areas. Full reliance on groundwater may provide additional benefits including reduced filtration requirements and corresponding reduction in capital, operations, and maintenance costs, and may result in reduced risk of crop damage and yield reduction due to harmful pathogens such as *Phytophthora*.²⁶

Groundwater is a shared resource that provides economic value to all users in the basin. The basin-wide benefits of increased recharge can be disaggregated into avoided energy and capital costs, reduced financial risk, and avoided third-party costs. Higher groundwater levels reduce

²⁶ *Phytophthora* is a type of water mold that can cause permanent damage to fruit and nut trees and is often referred to as “root and crown rot.”

the cost to lift and pressurize water for irrigation, the need to drill new wells, and how frequently existing wells need to be refurbished, providing direct operating cost and capital savings to irrigators in the basin. In addition, reliable access to groundwater improves irrigation and reduces the risk of water shortage, allowing basin irrigators to invest in higher-value per unit of water permanent crops. This results in firm, less flexible water demands over time and therefore allows a narrower range of demand management options. Finally, avoiding undesirable results specified in SGMA legislation provides additional economic benefits to third-parties in the basin. For example, costs associated with lifting groundwater from greater depths that would otherwise be incurred by municipal water suppliers relying on groundwater are avoided.

Some surface water suppliers in Butte County and the Sacramento Valley as a whole are challenged by the dynamics outlined above. Despite highly reliable surface water supplies from the Feather River and other sources, some permanent crop growers have abandoned surface water in favor of groundwater. Groundwater levels have begun to decline in some areas. Of greater concern to surface water suppliers is declining delivery of surface water and potential implications to the exercise and protection of water rights. Due to these concerns, some suppliers are exploring alternatives to attract surface water users back into their customer base, thereby benefitting groundwater conditions through in-lieu recharge.

6.2. Characterization of Dual Source Irrigation Systems

6.2.1. Overview

Existing fields with dual source systems were evaluated to quantify and characterize costs of in-lieu recharge. For a selected system, the detailed physical features; operational strategy; and capital, operating, and maintenance costs were characterized. The selected field is a new 250-acre walnut orchard located within Butte Water District. Detailed information on this and other selected fields was collected from field visits and interviews with growers, irrigation suppliers, and Butte County Resource Conservation District (RCD) staff.

Based on the selected field and consideration of other dual source systems in the Sacramento Valley and elsewhere in California, a cost estimation tool for broader application was developed. In addition to information for the selected fields, information gathered from interviews with irrigation suppliers, irrigation district staff, growers, agronomic consultants, and RCD staff was utilized. Characterization of dual source systems and development of the cost estimation tool are described in greater detail below.

6.2.2. Selected Systems

6.2.2.1. New 250-Acre Walnut Orchard

The evaluated dual source system is a walnut orchard located northwest of Live Oak in Sutter County. The orchard, planted in 2014, is within the Butte Water District (BWD) service area. The young trees are currently irrigated by a groundwater well drilled and completed in 2014 (Figure 6-1 and Figure 6-2). Water pumped by the well is filtered using a sand separator, followed by two parallel screen filters. The location of the well and filter station is shown in Figure 6-3. The equipment at the groundwater pump and filter station is summarized in Table 6-1.

When mature, crop water use will increase and the orchard will be irrigated by up to three (3) separate pump stations, including the existing well pump station and up to two (2) additional dual source pump stations. Both potential dual source pump stations will include a turnout from the canal, a sump or “can”²⁷, a groundwater well with a low head vertical turbine pump, and a second vertical turbine pump installed in the sump to pressurize the water for sprinkler irrigation (pressure pump). Both the turnout and well will discharge to the sump, allowing for either source to be pressurized for irrigation. The pressure pump will lift water from the sump and pressurize it for filtration and irrigation.

Wells for the two dual source stations were drilled adjacent to existing turnouts on the BWD canal in 2015, though well pumps and motors have not yet been installed. Initially one dual source station will be fully equipped and operated. The second dual source station will be added if irrigation demands are not met by the existing well and the first dual source pump station. All components of each dual source pump and filter station will be located next to the existing turnouts as shown in Figure 6-3. The equipment at each dual source pump and filter station is summarized in Table 6-1.

²⁷ A can is a section of corrugated metal pipe buried in the ground vertically and extending a couple feet above ground level to create a small reservoir from which water can be pumped.

Figure 6-1 Young Walnut Trees at 250-Acre Orchard



Figure 6-2 Station 1 Groundwater Well for 250-Acre Orchard



Figure 6-3 Layout of 250-Acre Walnut Orchard with Dual Source System

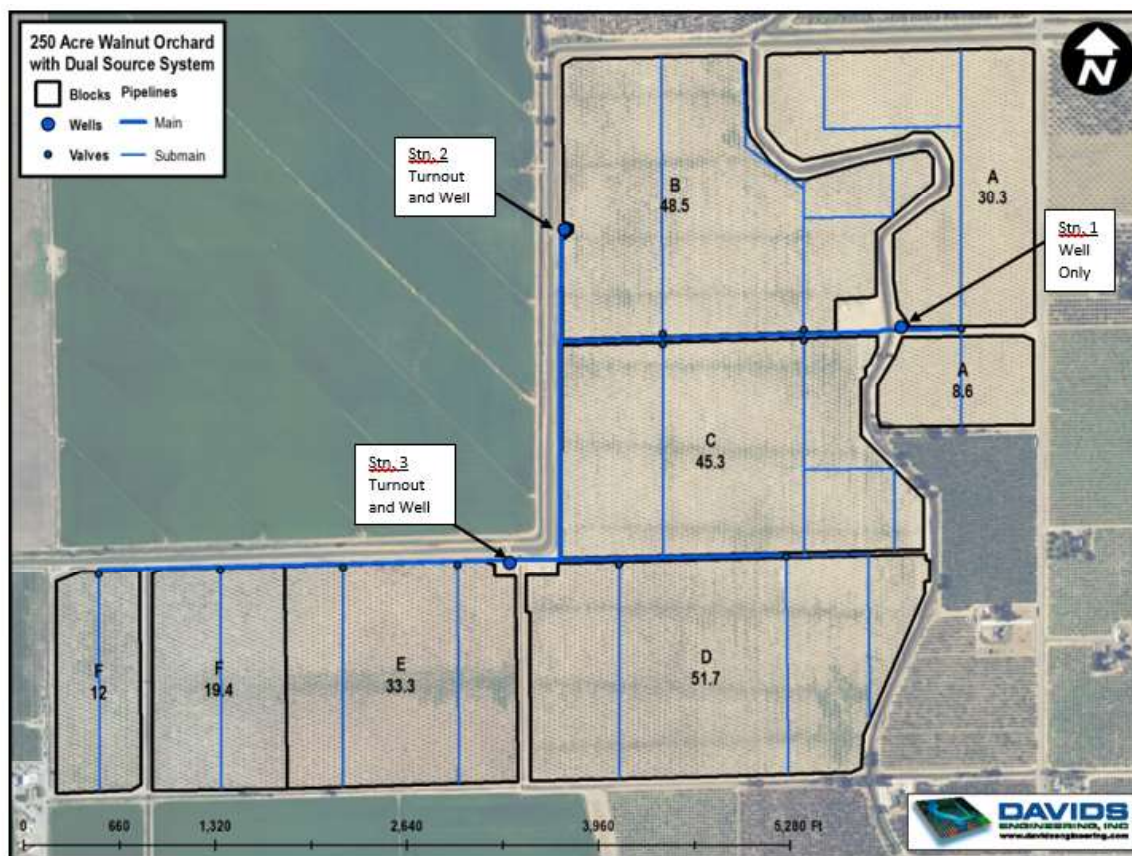

Table 6-1 Summary of Components at Each Pump and Filter Station

Component	Station 1 (GW Only)	Station 2 (Dual)	Station 3 (Dual)
Well pump	150 hp, vfd*	100 hp flood	100 hp flood
Can	N/A	48" CMP	48" CMP
Pressure pump	N/A	100 hp, vfd	100 hp, vfd
Sand separator	Yardney R100LA	N/A	N/A
Filter(s)	Two (2) Filtaworx FWO8, self-cleaning screens, 120 micron	Two (2) Filtaworx FWO8, self-cleaning screens, 120 micron	Two (2) Filtaworx FWO8, self-cleaning screen, 120 micron
Flow meter	10" SeaMetrics Magmeter	10" SeaMetrics Magmeter	10" SeaMetrics Magmeter
Manifold	10" steel pipe	10" steel pipe	10" steel pipe

* Variable Frequency Drive

The system is designed to run in six (6) sets or “blocks” as shown in Figure 6-3, with flows ranging from 1,344 gallons per minute (gpm) to 2,243 gpm per block. If all three pump and filter stations are installed, each station will be able to supply two alternating blocks. A summary of the irrigation system is provided in Table 6-2.

Table 6-2 Summary of 250-Acre Orchard Irrigation System

Crop	Walnuts
Planted	2014
Tree spacing	28' x 25' offset spacing (62 trees per acre)
Surface water source(s)	Up to two (2) turnouts from Butte Water District
Groundwater source(s)	Up to three (3) groundwater wells
Surface water percent utilization	Estimated greater than 90%
Groundwater percent utilization	Estimated less than 10%
Buried Mains and Submains	6" – 15" Class 100 IPS gasketed PVC 2" – 5" Class 125 IPS solvent weld PVC
Laterals	1-1/4" Class 125 IPS solvent weld PVC (buried)
Lateral and sprinkler spacing	45.7' x 30.7' (31 sprinklers per acre)
Emitters	Approx. (7,940) Nelson R2000 Rotators with K3-15 red plate and orange #11 nozzles
Emitter Flow and Design Pressure	1.36 gpm at 40 psi

When the orchard is mature, the general irrigation strategy will be to utilize surface water as much as it is available and to schedule irrigation using soil moisture monitoring. The system design allows for all three (3) stations to run at once, but the design maximum flowrates at each station are high enough that a single station should be able to meet the orchard's peak water demand. The capability of any one station to irrigate the entire orchard is considered a major benefit due to redundancy and operational efficiency. Ideally, only one of the dual source systems would be equipped and operated and would solely irrigate the entire orchard with the existing groundwater only station as a backup. The two potential limiting factors to this strategy are (1) surface water availability and (2) electric power time-of-use restrictions. If available surface water flows cannot meet crop demand, one or more of the groundwater wells will be used to irrigate. This is expected to be a rare occurrence due to the availability of surface water essentially on demand during the primary irrigation season. Exceptions could include drought years when surface water supplies are diminished or times when water is needed during the winter or early spring for frost protection or when conditions are exceptionally dry. If sufficient surface water is available, but any combination of (1) the timing of the surface water availability, (2) electric power time-of-use restrictions, or (3) crop water demand timing make it impossible

or uneconomical to irrigate from a single station, then the second dual source station will be equipped as well. Since multiple time-sensitive factors will need to be aligned to fully irrigate from a single station, the decision to equip the second dual source system will be made as the orchard approaches full maturity.

The dual source system and its irrigation strategy described above have associated costs that are likely to differ from the costs associated with a single source groundwater system for the same orchard. These cost differences or “marginal” costs²⁸ include capital, maintenance, and operations costs. The greatest additional capital costs for the dual system are the additional pressure pump at each dual source pump station and electrical line extensions to bring power to the existing turnout locations. The groundwater wells will be driven by Diesel power, while the pressure pumps will be driven using electric motors with variable frequency drives. For other orchards, gravity pipelines to convey surface water from turnouts to existing well locations could be required instead of electrical line extensions. This would also represent a substantial additional capital cost. Other additional capital costs include the cost of the sump and turnout connection and the cost of extending the mainline to the turnout locations. For this orchard, surface water and groundwater will be filtered using the same screen filters. For other dual systems, additional filtration may be needed for surface water, or less filtration may be needed for groundwater. Filtration needs depend on both the quality of the water and the type of irrigation method, with greater filtration needed for drip and microspray systems than for sprinklers.

The reduced lift required when pumping from the canal rather than the groundwater well results in reduced operating costs due to reduced energy required. The reduced energy cost is the only notable marginal operating cost savings for the 250-acre field. All pumps can be controlled remotely and all filters are self-cleaning, so operating time and associated costs are minimal. Estimated marginal energy costs account for the difference in energy required and assume a similar unit energy cost for pumping groundwater and surface water. If, for other orchards, surface water is not available during lower cost time-of-use periods for electric power, the actual unit energy costs for pumping surface water and groundwater may differ. The marginal maintenance costs are directly tied to the additional equipment needed for a dual source system. Each additional piece of equipment requires maintenance and an associated maintenance cost. A summary of all estimated marginal costs can be found in Table 6-3.

²⁸ Marginal costs are defined as the additional cost of a dual source system compared to a single source groundwater system, or cost of dual source minus cost of single source. In some cases, reduced operating costs may offset additional capital and maintenance costs, resulting in a net cost savings to the grower.

Table 6-3 Estimated Annual Costs and Cost Differences for Components of Single and Dual Source Systems: Example 250-Acre Walnut Orchard

Cost Item	Estimated Annual Cost		
	Single Source	Dual Source	Difference
Capital			
Pressure Pumps	\$1,350	\$3,900	\$2,550
Electrical Line Extension	\$0	\$3,050	\$3,050
Gravity Pipeline	\$0	\$200	\$200
Sump & Turnout Connection	\$0	\$850	\$850
SUBTOTAL	\$1,350	\$8,000	\$6,650
Operations and Maintenance			
Energy	\$48,350	\$40,800	-\$7,550
Equipment Maintenance	\$850	\$3,250	\$2,400
SUBTOTAL	\$49,200	\$44,050	-\$5,150
GRAND TOTAL	\$50,550	\$52,050	\$1,500

6.2.3. Development of General Cost Estimates and Cost Estimation Tool

6.2.3.1. Overview

Incremental cost estimates for dual source systems were developed by identifying typical system components and associated costs. A cost estimating tool allowing for specification of a wide range of system parameters was then developed. Parameters affecting capital, operating, and maintenance costs for dual source systems include field size, crop, irrigation system type, and other factors have been incorporated into the tool.

These cost estimates represent the incremental cost of installing and operating a dual source system relative to user-defined existing field and system conditions. This includes the capital and maintenance costs associated with adding additional components to the system to utilize surface water. Additionally, the tool estimates the difference in operating costs for utilizing surface water. In all cases, addition of dual system components (e.g. turnout, pump, filter, and conveyance, as needed) results in an increase in capital and maintenance costs. The incremental operations costs result in a net reduction in cost for energy to lift water (because the energy associated with groundwater pumping is always greater than that to lift surface water), but may

represent a net increase in overall operating costs depending on the cost to purchase surface water.

The tool is applicable for fields with an existing irrigation system and groundwater well or for fields installing a new system and surface water source. The tool does not include an estimate of the cost for the irrigation system itself, whether flood/furrow irrigation, sprinkler irrigation, or micro/drip irrigation. It is assumed that the irrigation system would already be in place when considering implementation of the dual system. When capital, maintenance and operations costs are summed, the cost difference between using surface water or groundwater can result in net cost savings depending on field-specific conditions.

6.2.3.2. Dual System Components

The typical system components required for a dual source system are (1) a surface water irrigation turnout, (2) a pipeline or ditch conveyance from the turnout to pump station, (3) a pump or pumps for pressurization, and (4) filtration²⁹. Although the layout and therefore cost differences for dual systems will vary from field to field, these four components generally account for the cost differences between a dual source system and a single source system.

6.2.3.2.1. Irrigation Turnout

An irrigation turnout provides a method to deliver surface water from a canal to a field or on-farm conveyance system and, when equipped with a screen or trash rack, a method to prevent large debris from entering the on-farm system. Turnouts typically consist of a submerged circular canal gate (Figure 6-4). In many cases, a screen or trash rack installed in the canal in front of the turnout gate is beneficial to prevent large debris from entering and potentially damaging or clogging the pump and filters (Figure 6-5). In some cases, the inlet piping of the pressure pump is equipped with a rotating, self-cleaning screen or other filter to enable pumping directly from the canal, thereby eliminating the need for a turnout gate (Figure 6-6).

²⁹ For dual source systems serving gravity irrigation systems (flood or furrow), pressurization and filtration are not required components.

Figure 6-4 Canal Turnout Gate without Trash Rack or Screen



Figure 6-5 Canal Turnout Gate with Trash Rack



Figure 6-6 Dual Source System with Self-Cleaning Rotating Screen Filter to Pump Directly from Canal

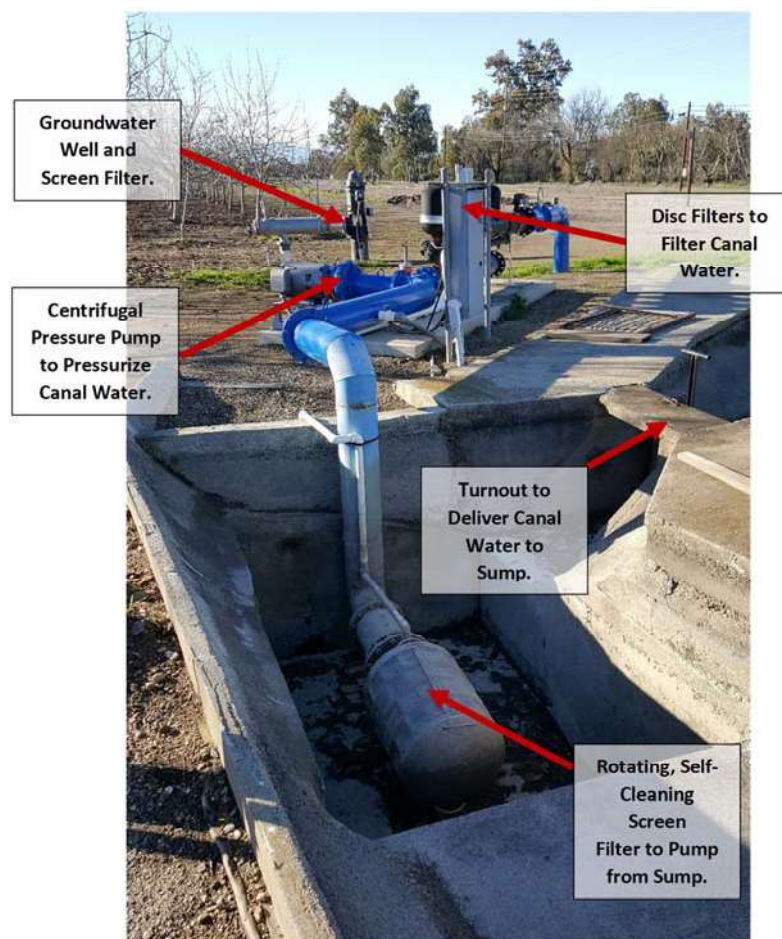

6.2.3.2.2. Pipeline or Ditch Conveyance

The conveyance component includes any additional ditches or pipelines that may be needed to convey surface water to the irrigation system³⁰. Surface water supplies in the area are all non-pressurized, so a pump or pumps may be needed to lift the surface water to the field, overcome any pipe friction losses, and/or provide pressurization for the irrigation system. Where water can be delivered via gravity, an open ditch or low head pipeline may be used to convey water to the point of pressurization. In other cases, a pressure pump would be used to provide the required

³⁰ Stated another way, these are any ditches or pipeline that would not be needed in a single source groundwater system, including any or all of the following: conveyance from the turnout to the farm, conveyance on the farm to the pump and filter station, and conveyance from the filter station to tie into a mainline shared with one or more groundwater wells.

pressure at the turnout, and a pipeline with suitable pressure rating installed to convey surface water to the point of tie in to the irrigation system.

6.2.3.2.3. Pressure Pump(s)

Typically, a centrifugal pressure pump (Figure 6-7) or vertical turbine sump pump (Figure 6-8) is used to overcome friction, provide lift, and pressurize surface water.

Figure 6-7 Rotating, Self-Cleaning Screen Filter Followed by Centrifugal Pressure Pump and Horizontal Screen Filter for Almond Irrigation



Figure 6-8 “Can” Type Sump and Vertical Turbine Pressure Pump Used to Pressurize Surface Water³¹

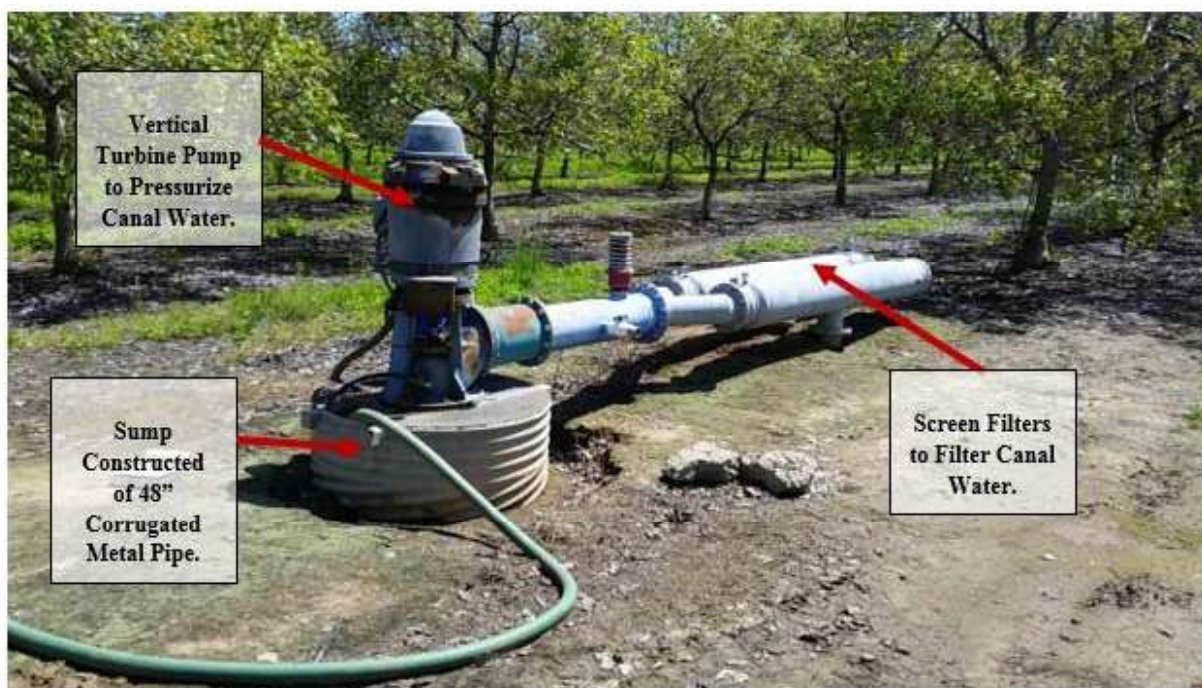

6.2.3.2.4. Filtration

Surface water typically contains solids, which may include inorganic materials (sand, silt, and clay), aquatic organisms (algae, weeds, and fish), and trash (sticks, litter, etc.). As a result, filtration is almost always required to use surface water in pressurized systems or when simply pumping water to lift it to the field. Proper filtration provides pump protection and prevents clogging of the irrigation system. Filtration may be accomplished in several stages, including construction of a small reservoir to settle solids prior to pumping, pre-screening at the turnout or pump intake using screens or trash racks, primary filtration downstream of the pump, and sometimes backup or secondary filtration downstream of the primary filter. The need for these different filtration components depends on the conditions of a given field.

For dual systems, the pump used to pressurize surface water may have its own filtration or share filtration with the groundwater well. Typical filter options include screen filters, media filters, and disc filters. Filter selection depends on the size and amount of debris in the source water and

³¹ The pump shown is, in fact, from a single source system in BWD for which surface water is the only water source available to irrigate 50 acres of walnuts with sprinklers. The components shown are the same as those that could be used in a dual system.

the potential to clog the irrigation system, which depends on the orifice size of emitters. Among pressurized irrigation systems, sprinklers have the largest orifices, followed by microspray, followed by surface or subsurface drip. As orifice size decreases, the potential for clogging and need for greater filtration increases. In many cases, a media or disc filter provides primary filtration, followed by a screen filter for extra protection downstream. For sprinkler systems, a screen filter alone is often sufficient.

Figure 6-6 shows an example of a dual source system where separate disc and screen filters are used to filter surface water and groundwater, respectively. Additional examples of filters used for canal water and other dual system components are shown in Figure 6-9 through Figure 6-11.

Figure 6-9 Rotating, Self-Cleaning Screen Filter Followed by Vertical Turbine Pressure Pump and Horizontal Screen Filter for Almond Irrigation. Screen Filter Installed Downstream of Combined Discharges of Pressure Pump and Groundwater Well



Figure 6-10 Self-Cleaning Mechanical Screen (Downstream of Turnout with Trash Rack), Centrifugal Pressure Pump, and Media Filters for Almond Irrigation with Microspray



Figure 6-11 Vertical Rectangular Screen Protecting Vertical Turbine Pressure Pump, Followed by Disc Filters for Prune Irrigation with Microspray



6.2.3.3. Factors Affecting Dual System Layout and Cost

As noted above, the layout and cost of dual source system components will vary from field to field based on several factors. These factors are discussed in greater detail below.

6.2.3.3.1. Field Size and Crop Water Requirements

A primary factor affecting the design of dual systems (and irrigation systems in general) is the capacity required. Peak capacity is a function of field size, peak crop evapotranspiration (ET), and the uniformity with which water is applied. For the Sacramento Valley, peak ET is around 0.3 to 0.4 inches per day for most crops, translating to approximately 7 to 9 gallons per minute (gpm) per acre based on a system distribution uniformity of 80%. For a 100-acre field, this translates into a required pump capacity of approximately 800 gpm. In many cases, systems may be designed with greater capacity (e.g. 12 gpm per acre) to be able to meet peak crop water requirements while avoiding pumping during peak energy demand periods to reduce electrical costs.

6.2.3.3.2. Distance

The distance from the surface water source to the point of application affects the required length of ditch or pipeline required to convey the water. Distances to consider include the distance from the turnout to the pressure pump and the distance from the pressure pump to the point at which the pump discharge ties into the system mainlines. This may be at the groundwater well or other location.

In addition to conveyance, the distance from the pressure pump to existing electrical distribution lines is a factor affecting cost for electric pumps.

6.2.3.3.3. Water Quality (Suspended Solids)

The type and amount of solids to be removed through filtration affects the number and types of filtration required. Generally, some form of pre-screening to remove large solids will be needed, followed by primary filtration downstream of the pressure pump. As discussed previously, selection of filtration also depends upon the orifice size of the sprinkler nozzles or emitters for pressurized systems.

6.2.3.3.4. Pressure Requirements

The amount of pressurization required includes any lift required to convey water from the turnout to the point of application, friction losses in the conveyance and irrigation system itself,

pressure loss through the filters, and discharge pressure required by the emitters. Sprinklers such as the Nelson R2000 rotator require approximately 45 pounds per square inch (psi), while microspray emitters such as the Olson Ultra-Jet require approximately 20 psi, and drip emitters can be operated at less than 10 psi.

6.2.3.4. Development of Unit Costs

For each of the dual system components listed above, capital cost items were identified, and unit costs were estimated for each item. Unit costs are associated with the size of each item (e.g. pipeline diameter, pump horsepower, etc.). Sources of unit cost data include current USDA Natural Resources Conservation Service payment schedules, local costs for recent irrigation hardware purchases provided by irrigation suppliers and the Butte County Resource Conservation District (BCRCD), supplier price lists, and an internal construction cost database maintained by Davids Engineering. A summary of estimated unit costs for dual system components is provided in Table 6-4.

Table 6-4 Dual Source System Component Unit Costs

Description	Unit Cost	Unit
Turnouts		
Precast concrete turnout with 12-inch canal gate and trash rack.	\$2,800	ea
Precast concrete turnout with 18-inch canal gate and trash rack.	\$4,100	ea
Precast concrete turnout with 24-inch canal gate and trash rack.	\$5,300	ea
Pipelines		
Buried PVC irrigation pipe, 6-inch diameter.	\$19	ft
Buried PVC irrigation pipe, 8-inch diameter.	\$26	ft
Buried PVC irrigation pipe, 10-inch diameter.	\$32	ft
Buried PVC irrigation pipe, 12-inch diameter.	\$38	ft
Buried PVC irrigation pipe, 15-inch diameter.	\$47	ft
Buried PVC irrigation pipe, 18-inch diameter.	\$57	ft
Buried PVC irrigation pipe, 21-inch diameter.	\$66	ft
Buried PVC irrigation pipe, 24-inch diameter.	\$75	ft
Pressure Pumps		
Pressure pump, 10 horsepower.	\$5,200	ea
Pressure pump, 20 horsepower.	\$8,000	ea
Pressure pump, 40 horsepower.	\$13,400	ea
Pressure pump, 60 horsepower.	\$18,200	ea
Pressure pump, 80 horsepower.	\$22,400	ea
Pressure pump, 100 horsepower.	\$26,200	ea

Description	Unit Cost	Unit
Filters		
Screen filter, 1000 gpm.	\$5,000	ea
Media filter, 500 gpm.	\$5,600	ea
Media filter, 1000 gpm.	\$10,200	ea
Media filter, 1500 gpm.	\$14,800	ea
Media filter, 2000 gpm.	\$19,400	ea
Flow Meters		
Flow Meter, 8-inch.	\$3,400	ea
Flow Meter, 10-inch.	\$4,300	ea
Flow Meter, 12-inch.	\$5,100	ea
Flow Meter, 15-inch.	\$6,200	ea
Flow Meter, 18-inch.	\$7,300	ea

6.2.3.5. Estimation of Useful Lives and Maintenance Costs for System Components

In addition to unit costs for each system component, the useful life and annual maintenance cost are estimated. The useful life represents the approximate number of years each component is expected to function before it needs to be replaced. Annual maintenance costs are estimates as a percentage of upfront capital costs. A summary of estimated component lives and maintenance cost percentages is provided in Table 6-5.

Table 6-5 Dual Source System Component Useful Lives and Annual Maintenance

Component Type	Useful Life (years)	Annual Maintenance (%)
Turnout	30	1%
Pipeline	30	1%
Pump	15	3%
Filter	15	3%
Flow Meter	15	3%
Electrical Service	50	1%

The useful life of each component is used to amortize the upfront capital costs to determine an annualized capital cost for the dual source system. An amortization rate of 4% is assumed.

6.2.3.6. Estimation of Contingencies and Indirect Costs

The total estimated capital cost of a dual source system includes the total upfront cost of the system components identified above, as well as various additional unlisted components (valves,

fittings, etc.) and costs (mobilization and demobilization, tax, freight, prevailing wage, etc.). To account for these additional costs, a 30% markup is added to the estimated costs of each component.

6.2.3.7. Operations Costs

Operations costs for dual source systems include the cost of surface water and groundwater. Surface water costs include purchasing surface water from the supplier and the cost of pumping and pressurizing the water. Groundwater costs include the cost of lifting the water and pressurizing it.

6.2.3.8. Cost Estimation Tool and Costing Examples

The cost estimation tool was developed to evaluate the cost difference between dual source and groundwater only irrigation systems. The tool allows for a wide range of costing scenarios based on 16 user-specified parameters listed in Table 6-6. User selections are limited to estimated plausible ranges, resulting in realistic scenarios. Default values represent a 100-acre walnut orchard with features generally representative of orchards in the region that are adjacent to an existing canal with surface water available.

Table 6-6 Dual Source System Cost Estimation Tool Parameters

Parameter	Units	Description	Options/Expected Range	Default
Crop	NA	Used to estimate irrigation demands	Alfalfa, Almonds, Corn, Beans, Grain, Olives, Prunes, Wetlands, Rice, Safflower, Sunflower, Tomatoes, Vineyard, or Walnuts	Walnuts
Field Size	Acres	Used to estimate required flow rate, pipe size, pump size, filter size, etc.	10 to 1,000 acres	100
Distance from Surface Water Source	Feet	Used to estimate pipe lengths and friction losses	0 to 50,000 feet	50
Elevation Difference Between Field and Surface Water Source	Feet	Used to estimate pump size	0 to 500 feet	5
Irrigation System Type	NA	Used to estimate filtration and pressure requirements	Flood, Sprinkler, or Drip/Micro	Sprinkler
Existing Turnout	NA	Indicates whether a turnout is already present. Used to estimate turnout cost	True or False	FALSE

Parameter	Units	Description	Options/Expected Range	Default
Percent of Demand Met by Surface Water	%	Used to estimate surface water and groundwater amounts and costs	0 to 100%	100%
Static Depth to Groundwater	Feet	Used to estimate required lift for groundwater and associated costs	0 to 300 feet	50
Specific Capacity	Gal/min/ft	Used to estimate required lift for groundwater and associated costs	10 to 80 gpm/ft	50
Surface Water Purchase Cost	\$ per Acre-Foot	Used to estimate surface water costs	\$0 to \$500 per acre-foot	\$5
Distance from Pressure Pump to Tie-In to Irrigation System	Feet	Used to estimate pipe lengths and friction losses	0 to 5,000 feet	1000
Distance from Pressure Pump to Existing Electrical Service	Feet	Used to estimate cost of new electric service	0 to 5,000 feet	50
Groundwater Extraction Fee	\$ per Acre-Foot	Used to estimate groundwater extraction fees	\$0 to \$500 per acre-foot	\$0
Peak Crop Water Demand	Gallons per Minute per Acre	Used to estimate irrigation system capacity.	5 to 10 gpm/ac	12
Overall Pumping Plant Efficiency	%	Used to estimate pump size and energy costs	40% to 90%	65%
Energy Cost	\$ per Kilowatt-Hour	Used to estimate pumping costs	\$0.10 to \$0.50 per kWh	\$0.25
Contingencies and Indirect Costs	%	Used to mark up capital costs to reflect unlisted items and uncertainties	0% to 100%.	30%
Maximum well drawdown	Feet	Used to avoid overestimating lift for large fields or ranches where more than one well would likely be present	0 to 200 feet.	60

6.2.3.8.1. Example: 100-Acre Walnut Orchard

To illustrate the use of the tool, the estimated cost difference of a dual source system for the default field was evaluated over a range of surface water costs and static depth to groundwater. Results for the default 100-acre walnut orchard are shown in Table 6-7.

The estimated up-front cost of the dual source system, including turnout, pipelines, pump, filter, flow meter, and other unlisted items is approximately \$86,580. This results in an estimated annual capital cost of \$6,200 (62\$/ac) and maintenance cost of \$1,622 (\$16/ac). Based on an estimated annual irrigation demand of approximately 282 acre-feet (ac-ft), the total operational cost of using surface water is estimated to be \$16,333 (\$163/ac), compared to \$32,443 (\$324/ac) if groundwater were used. Thus, the marginal capital and maintenance cost of the dual source system is approximately \$78/ac ($78 = 62 + 16$), which is offset by a reduced operating cost of approximately \$161/ac ($161 = 324 - 163$), resulting in a net cost savings of \$83/ac ($83 = 161 - 78$) annually.

To evaluate net costs of dual source systems across a range of surface water costs and static depths to groundwater, a series of costing scenarios was evaluated with surface water costs ranging from \$5/ac-ft to \$75/ac-ft and static water depths of 10 feet to 100 feet.

Figure 6-12 shows estimated differences in operating costs between a single source (groundwater only) and dual source system using solely surface water. For surface water at a cost of \$5/af, there is an estimated net savings in operating costs of between \$28/ac for a static groundwater depth of 10 ft and \$138/ac for a static groundwater depth of 100 ft. In contrast, for surface water at a cost of \$75/af, there is an estimated net additional operating cost of between \$170/ac for a static groundwater depth of 10 ft and \$60/ac for a static groundwater depth of 100 ft.

Table 6-7 Cost Estimation Tool Results for Default 100-Acre Walnut Orchard

Annual Capital and Maintenance Costs																																																											
<table border="1"> <thead> <tr> <th colspan="2">Input Parameters</th> </tr> </thead> <tbody> <tr> <td>Crop</td> <td>Walnuts</td> </tr> <tr> <td>Field size (Acres)</td> <td>100</td> </tr> <tr> <td>Field distance from canal (ft)</td> <td>50</td> </tr> <tr> <td>Field elevation above canal (ft)</td> <td>5</td> </tr> <tr> <td>Electrical connection distance (ft)</td> <td>50</td> </tr> <tr> <td>System type</td> <td>Sprinkler</td> </tr> <tr> <td>Turnout Present</td> <td>FALSE</td> </tr> </tbody> </table>				Input Parameters		Crop	Walnuts	Field size (Acres)	100	Field distance from canal (ft)	50	Field elevation above canal (ft)	5	Electrical connection distance (ft)	50	System type	Sprinkler	Turnout Present	FALSE	<table border="1"> <thead> <tr> <th colspan="4">Calculated Parameters</th> </tr> </thead> <tbody> <tr> <td>Flow (gpm)</td> <td>1,200</td> <td>Lift (ft)</td> <td>5</td> </tr> <tr> <td>Raw Pipe Dia. (in)</td> <td>10</td> <td>Friction loss (ft)</td> <td>7</td> </tr> <tr> <td>Nominal Pipe diameter (in)</td> <td>10</td> <td>Filter loss (psi)</td> <td>3</td> </tr> <tr> <td>Actual Pipe diameter (in)</td> <td>10.2</td> <td>Field Pressure (psi)</td> <td>50</td> </tr> <tr> <td>Water Velocity (ft/s)</td> <td>4.7</td> <td>SW TDH (ft)</td> <td>135</td> </tr> <tr> <td>Screen filter present</td> <td>TRUE</td> <td>Pump power (hp)</td> <td>63</td> </tr> <tr> <td>Media filter present</td> <td>FALSE</td> <td></td> <td></td> </tr> <tr> <td>On-field conn. distance (ft)</td> <td>1,000</td> <td></td> <td></td> </tr> </tbody> </table>				Calculated Parameters				Flow (gpm)	1,200	Lift (ft)	5	Raw Pipe Dia. (in)	10	Friction loss (ft)	7	Nominal Pipe diameter (in)	10	Filter loss (psi)	3	Actual Pipe diameter (in)	10.2	Field Pressure (psi)	50	Water Velocity (ft/s)	4.7	SW TDH (ft)	135	Screen filter present	TRUE	Pump power (hp)	63	Media filter present	FALSE			On-field conn. distance (ft)	1,000		
Input Parameters																																																											
Crop	Walnuts																																																										
Field size (Acres)	100																																																										
Field distance from canal (ft)	50																																																										
Field elevation above canal (ft)	5																																																										
Electrical connection distance (ft)	50																																																										
System type	Sprinkler																																																										
Turnout Present	FALSE																																																										
Calculated Parameters																																																											
Flow (gpm)	1,200	Lift (ft)	5																																																								
Raw Pipe Dia. (in)	10	Friction loss (ft)	7																																																								
Nominal Pipe diameter (in)	10	Filter loss (psi)	3																																																								
Actual Pipe diameter (in)	10.2	Field Pressure (psi)	50																																																								
Water Velocity (ft/s)	4.7	SW TDH (ft)	135																																																								
Screen filter present	TRUE	Pump power (hp)	63																																																								
Media filter present	FALSE																																																										
On-field conn. distance (ft)	1,000																																																										
Item Description	QTY	UNIT	Unit Cost	Extended Cost	Equivalent Annual Cost	Annual Maint.	Annual Cost																																																				
Category 1																																																											
Turnout	1	ea	\$ 2,400	\$ 2,400	\$ 139	\$ 24	\$ 163																																																				
Supply Connection Pipeline	50	ft	\$ 32	\$ 1,600	\$ 93	\$ 16	\$ 109																																																				
Pressure Pump	1	ea	\$ 18,800	\$ 18,800	\$ 1,691	\$ 564	\$ 2,255																																																				
Screen Filter(s)	1	ea	\$ 6,000	\$ 6,000	\$ 540	\$ 180	\$ 720																																																				
Media Filter(s)	0	ea	\$ 12,000	\$ -	\$ -	\$ -	\$ -																																																				
On-Field Connection Pipeline	1,000	ft	\$ 32	\$ 32,000	\$ 1,851	\$ 320	\$ 2,171																																																				
Flow Meter	1	ea	\$ 4,300	\$ 4,300	\$ 387	\$ 129	\$ 516																																																				
Electrical Line Extension	50	ft	\$ 30	\$ 1,500	\$ 70	\$ 15	\$ 85																																																				
				Subtotal of Pay Items=	\$ 66,600	\$ 4,769	\$ 1,248	\$ 6,017																																																			
Contingencies and Indirect Costs			30%	\$ 19,980	\$ 1,431	\$ 374	\$ 1,805																																																				
				Project Cost =	\$ 86,580	\$ 6,200	\$ 1,622	\$ 7,822																																																			
Annual Operating Costs																																																											
<table border="1"> <thead> <tr> <th colspan="2">Input Parameters</th> </tr> </thead> <tbody> <tr> <td>Percent of demand met by surface water</td> <td>100%</td> </tr> <tr> <td>Static depth to water (ft)</td> <td>50</td> </tr> <tr> <td>Specific capacity (gpm/ft)</td> <td>50</td> </tr> <tr> <td>Surface water purchase cost (\$/af)</td> <td>\$5</td> </tr> <tr> <td>GW extraction cost (\$/af)</td> <td>\$0</td> </tr> </tbody> </table>				Input Parameters		Percent of demand met by surface water	100%	Static depth to water (ft)	50	Specific capacity (gpm/ft)	50	Surface water purchase cost (\$/af)	\$5	GW extraction cost (\$/af)	\$0	<table border="1"> <thead> <tr> <th colspan="2">Calculated Parameters (See Global Parameter Calcs for Assumptions)</th> </tr> </thead> <tbody> <tr> <td>Surface water pumping cost (\$/af)</td> <td>\$53</td> </tr> <tr> <td>Surface water total cost (\$/af)</td> <td>\$58</td> </tr> <tr> <td>Well Drawdown (ft)</td> <td>105</td> </tr> <tr> <td>GW Lift (ft)</td> <td>155</td> </tr> <tr> <td>GW Friction Losses (ft)</td> <td>15</td> </tr> <tr> <td>GW TDH (ft)</td> <td>292</td> </tr> <tr> <td>Groundwater pumping cost (\$/af)</td> <td>\$115</td> </tr> <tr> <td>Groundwater total cost (\$/af)</td> <td>\$115</td> </tr> </tbody> </table>				Calculated Parameters (See Global Parameter Calcs for Assumptions)		Surface water pumping cost (\$/af)	\$53	Surface water total cost (\$/af)	\$58	Well Drawdown (ft)	105	GW Lift (ft)	155	GW Friction Losses (ft)	15	GW TDH (ft)	292	Groundwater pumping cost (\$/af)	\$115	Groundwater total cost (\$/af)	\$115																						
Input Parameters																																																											
Percent of demand met by surface water	100%																																																										
Static depth to water (ft)	50																																																										
Specific capacity (gpm/ft)	50																																																										
Surface water purchase cost (\$/af)	\$5																																																										
GW extraction cost (\$/af)	\$0																																																										
Calculated Parameters (See Global Parameter Calcs for Assumptions)																																																											
Surface water pumping cost (\$/af)	\$53																																																										
Surface water total cost (\$/af)	\$58																																																										
Well Drawdown (ft)	105																																																										
GW Lift (ft)	155																																																										
GW Friction Losses (ft)	15																																																										
GW TDH (ft)	292																																																										
Groundwater pumping cost (\$/af)	\$115																																																										
Groundwater total cost (\$/af)	\$115																																																										
Month	Applied Water (ac-ft)	Applied Surface Water (ac-ft)	Applied Ground-water (ac-ft)	Surface Water Cost (\$)	GW Cost (\$)	Total Water Cost (\$)	GW Only Cost (\$)	Change in Cost by Using Surface Water (\$)																																																			
January	3.8	3.8	0.0	\$ 218	\$ -	\$ 218	\$ 432	(\$215)																																																			
February	1.2	1.2	0.0	\$ 71	\$ -	\$ 71	\$ 141	(\$70)																																																			
March	2.6	2.6	0.0	\$ 152	\$ -	\$ 152	\$ 301	(\$150)																																																			
April	14.0	14.0	0.0	\$ 810	\$ -	\$ 810	\$ 1,609	(\$799)																																																			
May	42.5	42.5	0.0	\$ 2,464	\$ -	\$ 2,464	\$ 4,893	(\$2,430)																																																			
June	57.1	57.1	0.0	\$ 3,306	\$ -	\$ 3,306	\$ 6,566	(\$3,260)																																																			
July	59.1	59.1	0.0	\$ 3,426	\$ -	\$ 3,426	\$ 6,804	(\$3,379)																																																			
August	50.3	50.3	0.0	\$ 2,914	\$ -	\$ 2,914	\$ 5,788	(\$2,874)																																																			
September	31.0	31.0	0.0	\$ 1,795	\$ -	\$ 1,795	\$ 3,565	(\$1,770)																																																			
October	15.8	15.8	0.0	\$ 916	\$ -	\$ 916	\$ 1,820	(\$904)																																																			
November	2.7	2.7	0.0	\$ 158	\$ -	\$ 158	\$ 314	(\$156)																																																			
December	1.8	1.8	0.0	\$ 105	\$ -	\$ 105	\$ 209	(\$104)																																																			
Total	282.0	282.0	0.0	\$ 16,333	\$ -	\$16,333	\$ 32,443	(\$16,110)																																																			

Figure 6-12 Estimated Difference in Operating Costs for Example 100-Acre Walnut Orchard with Surface Water Costs of \$5/af to \$75/af and Static Depth to Groundwater of 10 ft to 100 ft

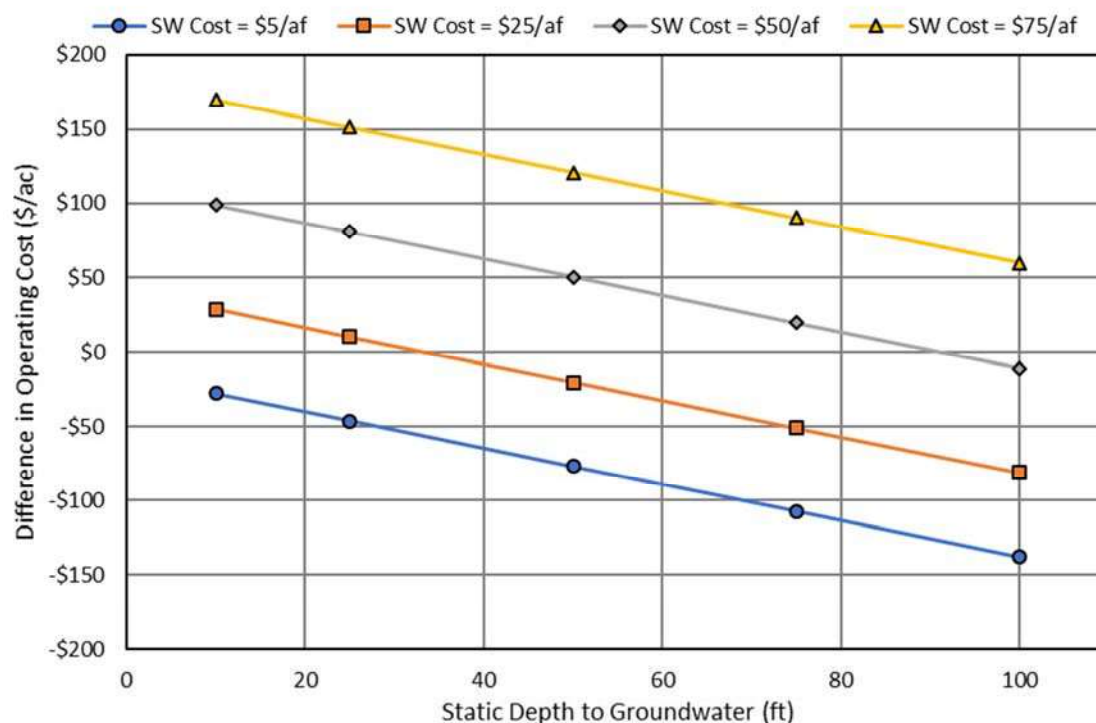

The cost difference of the dual source system must also consider the annualized capital and maintenance costs of the dual source system, which are the same regardless of the surface water purchase cost and static depth to groundwater. Combining the annualized capital and maintenance costs with the difference in operating costs shown in Figure 6-12, the total annual cost difference of the dual source system can be estimated (Figure 6-13). For surface water at a cost of \$5/af, there is an estimated net cost of \$38/ac for a static groundwater depth of 10 ft and an estimated net savings of \$72/ac for a static groundwater depth of 100 ft. In contrast, for surface water at a cost of \$75/af, there is an estimated net cost of between \$235/ac for a static groundwater depth of 10 ft and \$125/ac for a static groundwater depth of 100 ft.

Figure 6-13 Estimated Net Annual Cost of Dual Source System for Example 100-Acre Walnut Orchard with Surface Water Costs of \$5/af to \$75/af and Static Depth to Groundwater of 10 ft to 100ft

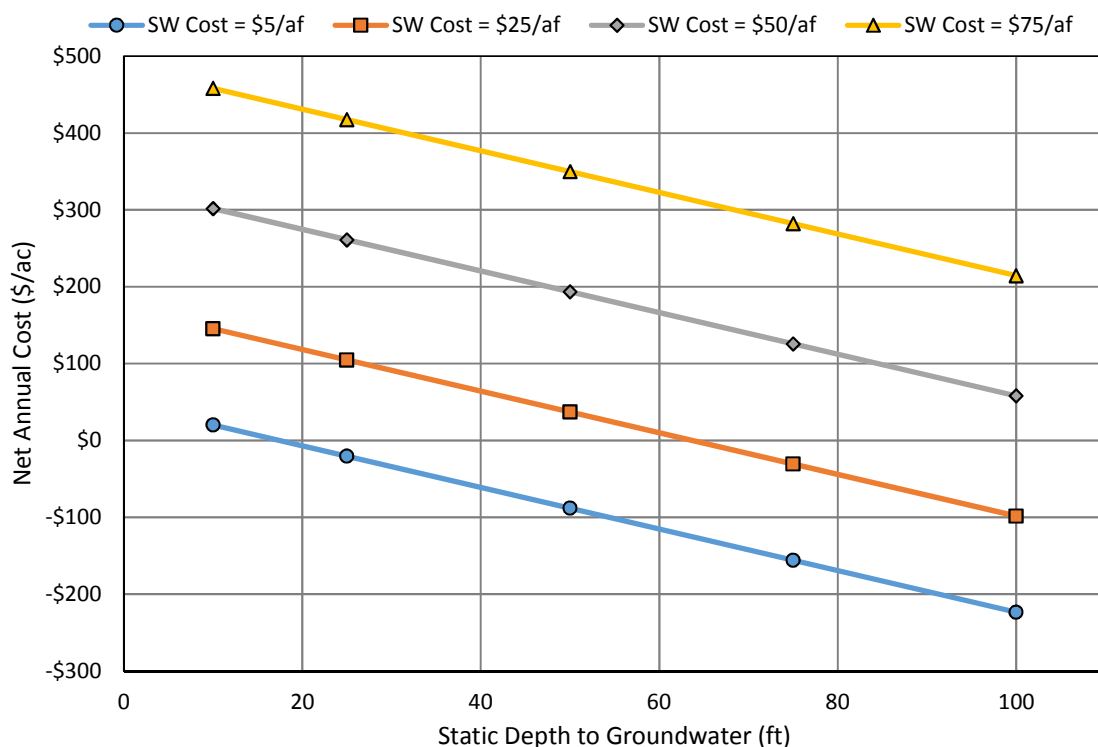

6.2.3.8.2. Example: 320-Acre Rice Farm

As another example to illustrate the use of the tool, the estimated cost difference of a dual source system for a hypothetical 320-acre, groundwater irrigated rice farm was evaluated over a range of surface water costs and static depth to groundwater. Results for the hypothetical 320-acre rice farm for a surface water cost of \$25/af and static depth to water of 50 ft are shown in Table 6-8. For this example, it is assumed that the source of surface water is approximately $\frac{1}{2}$ mile distant from the field and requires 20 feet of lift to overcome elevation differences. Additionally, it is assumed that the water can be applied directly once it reaches the field and does not need to be conveyed across the field to tie in to the hypothetical existing groundwater well.

Table 6-8 Cost Estimation Tool Results for Example 320-Acre Rice Farm

Annual Capital and Maintenance Costs																																																											
<table border="1"> <thead> <tr> <th colspan="2">Input Parameters</th> </tr> </thead> <tbody> <tr> <td>Crop</td> <td>Rice with Winter Water</td> </tr> <tr> <td>Field size (Acres)</td> <td>320</td> </tr> <tr> <td>Field distance from canal (ft)</td> <td>2640</td> </tr> <tr> <td>Field elevation above canal (ft)</td> <td>20</td> </tr> <tr> <td>Electrical connection distance (ft)</td> <td>0</td> </tr> <tr> <td>System type</td> <td>Flood</td> </tr> <tr> <td>Turnout Present</td> <td>FALSE</td> </tr> </tbody> </table>				Input Parameters		Crop	Rice with Winter Water	Field size (Acres)	320	Field distance from canal (ft)	2640	Field elevation above canal (ft)	20	Electrical connection distance (ft)	0	System type	Flood	Turnout Present	FALSE	<table border="1"> <thead> <tr> <th colspan="4">Calculated Parameters</th> </tr> </thead> <tbody> <tr> <td>Flow (gpm)</td> <td>3,840</td> <td>Lift (ft)</td> <td>20</td> </tr> <tr> <td>Raw Pipe Dia. (in)</td> <td>18</td> <td>Friction loss (ft)</td> <td>10</td> </tr> <tr> <td>Nominal Pipe diameter (in)</td> <td>18</td> <td>Filter loss (psi)</td> <td>0</td> </tr> <tr> <td>Actual Pipe diameter (in)</td> <td>17.7</td> <td>Field Pressure (psi)</td> <td>0</td> </tr> <tr> <td>Water Velocity (ft/s)</td> <td>5.0</td> <td>SW TDH (ft)</td> <td>30</td> </tr> <tr> <td>Screen filter present</td> <td>FALSE</td> <td>Pump power (hp)</td> <td>45</td> </tr> <tr> <td>Media filter present</td> <td>FALSE</td> <td></td> <td></td> </tr> <tr> <td>On-field conn. distance (ft)</td> <td>0</td> <td></td> <td></td> </tr> </tbody> </table>				Calculated Parameters				Flow (gpm)	3,840	Lift (ft)	20	Raw Pipe Dia. (in)	18	Friction loss (ft)	10	Nominal Pipe diameter (in)	18	Filter loss (psi)	0	Actual Pipe diameter (in)	17.7	Field Pressure (psi)	0	Water Velocity (ft/s)	5.0	SW TDH (ft)	30	Screen filter present	FALSE	Pump power (hp)	45	Media filter present	FALSE			On-field conn. distance (ft)	0		
Input Parameters																																																											
Crop	Rice with Winter Water																																																										
Field size (Acres)	320																																																										
Field distance from canal (ft)	2640																																																										
Field elevation above canal (ft)	20																																																										
Electrical connection distance (ft)	0																																																										
System type	Flood																																																										
Turnout Present	FALSE																																																										
Calculated Parameters																																																											
Flow (gpm)	3,840	Lift (ft)	20																																																								
Raw Pipe Dia. (in)	18	Friction loss (ft)	10																																																								
Nominal Pipe diameter (in)	18	Filter loss (psi)	0																																																								
Actual Pipe diameter (in)	17.7	Field Pressure (psi)	0																																																								
Water Velocity (ft/s)	5.0	SW TDH (ft)	30																																																								
Screen filter present	FALSE	Pump power (hp)	45																																																								
Media filter present	FALSE																																																										
On-field conn. distance (ft)	0																																																										
Item Description	QTY	UNIT	Unit Cost	Extended Cost	Equivalent Annual Cost	Annual Maint.	Annual Cost																																																				
Category 1																																																											
Turnout	1	ea	\$ 4,000	\$ 4,000	\$ 231	\$ 40	\$ 271																																																				
Supply Connection Pipeline	2640	ft	\$ 56	\$ 147,840	\$ 8,550	\$ 1,478	\$ 10,028																																																				
Pressure Pump	0	ea	\$ 14,700	\$ -	\$ -	\$ -	\$ -																																																				
Screen Filter(s)	0	ea	\$ 19,200	\$ -	\$ -	\$ -	\$ -																																																				
Media Filter(s)	0	ea	\$ 36,300	\$ -	\$ -	\$ -	\$ -																																																				
On-Field Connection Pipeline	0	ft	\$ 56	\$ -	\$ -	\$ -	\$ -																																																				
Flow Meter	2	ea	\$ 7,200	\$ 14,400	\$ 1,295	\$ 432	\$ 1,727																																																				
Electrical Line Extension	0	ft	\$ 31	\$ -	\$ -	\$ -	\$ -																																																				
				Subtotal of Pay Items=	\$ 166,240	\$ 10,076	\$ 1,950	\$ 12,026																																																			
Contingencies and Indirect Costs			30%	\$ 49,872	\$ 3,023	\$ 585	\$ 3,608																																																				
				Project Cost =	\$ 216,112	\$ 13,099	\$ 2,536	\$ 15,634																																																			
Annual Operating Costs																																																											
<table border="1"> <thead> <tr> <th colspan="2">Input Parameters</th> </tr> </thead> <tbody> <tr> <td>Percent of demand met by surface water</td> <td>100%</td> </tr> <tr> <td>Static depth to water (ft)</td> <td>50</td> </tr> <tr> <td>Specific capacity (gpm/ft)</td> <td>50</td> </tr> <tr> <td>Surface water purchase cost (\$/af)</td> <td>\$25</td> </tr> <tr> <td>GW extraction cost (\$/af)</td> <td>\$0</td> </tr> </tbody> </table>				Input Parameters		Percent of demand met by surface water	100%	Static depth to water (ft)	50	Specific capacity (gpm/ft)	50	Surface water purchase cost (\$/af)	\$25	GW extraction cost (\$/af)	\$0	<table border="1"> <thead> <tr> <th colspan="2">Calculated Parameters (See Global Parameter Calcs for Assumptions)</th> </tr> </thead> <tbody> <tr> <td>Surface water pumping cost (\$/af)</td> <td>\$12</td> </tr> <tr> <td>Surface water total cost (\$/af)</td> <td>\$37</td> </tr> <tr> <td>Well Drawdown (ft)</td> <td>60</td> </tr> <tr> <td>GW Lift (ft)</td> <td>110</td> </tr> <tr> <td>GW Friction Losses (ft)</td> <td>11</td> </tr> <tr> <td>GW TDH (ft)</td> <td>121</td> </tr> <tr> <td>Groundwater pumping cost (\$/af)</td> <td>\$48</td> </tr> <tr> <td>Groundwater total cost (\$/af)</td> <td>\$48</td> </tr> </tbody> </table>				Calculated Parameters (See Global Parameter Calcs for Assumptions)		Surface water pumping cost (\$/af)	\$12	Surface water total cost (\$/af)	\$37	Well Drawdown (ft)	60	GW Lift (ft)	110	GW Friction Losses (ft)	11	GW TDH (ft)	121	Groundwater pumping cost (\$/af)	\$48	Groundwater total cost (\$/af)	\$48																						
Input Parameters																																																											
Percent of demand met by surface water	100%																																																										
Static depth to water (ft)	50																																																										
Specific capacity (gpm/ft)	50																																																										
Surface water purchase cost (\$/af)	\$25																																																										
GW extraction cost (\$/af)	\$0																																																										
Calculated Parameters (See Global Parameter Calcs for Assumptions)																																																											
Surface water pumping cost (\$/af)	\$12																																																										
Surface water total cost (\$/af)	\$37																																																										
Well Drawdown (ft)	60																																																										
GW Lift (ft)	110																																																										
GW Friction Losses (ft)	11																																																										
GW TDH (ft)	121																																																										
Groundwater pumping cost (\$/af)	\$48																																																										
Groundwater total cost (\$/af)	\$48																																																										
Month	Applied Water (ac-ft)	Applied Surface Water (ac-ft)	Applied Ground-water (ac-ft)	Surface Water Cost (\$)	GW Cost (\$)	Total Water Cost (\$)	GW Only Cost (\$)	Change in Cost by Using Surface Water (\$)																																																			
January	109.7	109.7	0.0	\$ 4,055	\$ -	\$ 4,055	\$ 5,221	(\$1,166)																																																			
February	41.6	41.6	0.0	\$ 1,538	\$ -	\$ 1,538	\$ 1,980	(\$442)																																																			
March	0.0	0.0	0.0	\$ -	\$ -	\$ -	\$ -	\$0																																																			
April	101.7	101.7	0.0	\$ 3,760	\$ -	\$ 3,760	\$ 4,841	(\$1,081)																																																			
May	314.0	314.0	0.0	\$ 11,608	\$ -	\$ 11,608	\$ 14,944	(\$3,336)																																																			
June	346.9	346.9	0.0	\$ 12,825	\$ -	\$ 12,825	\$ 16,511	(\$3,686)																																																			
July	334.7	334.7	0.0	\$ 12,373	\$ -	\$ 12,373	\$ 15,930	(\$3,556)																																																			
August	234.2	234.2	0.0	\$ 8,657	\$ -	\$ 8,657	\$ 11,146	(\$2,488)																																																			
September	10.9	10.9	0.0	\$ 404	\$ -	\$ 404	\$ 520	(\$116)																																																			
October	287.6	287.6	0.0	\$ 10,634	\$ -	\$ 10,634	\$ 13,690	(\$3,056)																																																			
November	130.8	130.8	0.0	\$ 4,836	\$ -	\$ 4,836	\$ 6,226	(\$1,390)																																																			
December	90.0	90.0	0.0	\$ 3,326	\$ -	\$ 3,326	\$ 4,282	(\$956)																																																			
Total	2002.2	2002.2	0.0	\$ 74,017	\$ -	\$ 74,017	\$ 95,291	(\$21,274)																																																			

The estimated up-front cost of the dual source system, including turnout, pipelines, pump, filter, flow meter, and other unlisted items is approximately \$216,112. This results in an estimated annual capital cost of \$13,099 (\$41/ac) and maintenance cost of \$2,536 (\$8/ac). Based on an estimated annual irrigation demand of approximately 2,002 ac-ft, the total operational cost of surface water is estimated to be \$74,017 (\$231/ac), compared to \$95,291 (\$298/ac) if groundwater were used. Thus, the marginal capital and maintenance cost of the dual source system is approximately \$49/ac ($49 = 41 + 8$), which is offset by a reduced operating cost of approximately \$67/ac ($67 = 298 - 231$), resulting in a net cost savings of \$18/ac for the dual system ($18 = 67 - 49$).

To evaluate cost differences for dual source systems across a range of surface water costs and static depths to groundwater, a series of costing scenarios was evaluated with surface water costs ranging from \$5/ac-ft to \$75/ac-ft and static water depths of 10 feet to 100 feet.

Figure 6-14 shows estimated differences in operating costs between a single source (groundwater only) and dual source system using solely surface water. For surface water at a cost of \$5/af, there is an estimated net savings in operating costs of between \$23/ac for a static groundwater depth of 10 ft and \$266/ac for a static groundwater depth of 100 ft. In contrast, for surface water at a cost of \$75/af, there is an estimated net additional operating cost of between \$415/ac for a static groundwater depth of 10 ft and \$172/ac for a static groundwater depth of 100 ft.

The cost difference of the dual source system must also consider the annualized capital and maintenance costs of the dual source system, which are the same regardless of the surface water purchase cost and static depth to groundwater. Combining the annualized capital and maintenance costs with the difference in operating costs shown in Figure 6-14, the net annual cost of the dual source system can be estimated (Figure 6-15). For surface water at a cost of \$5/af, there is an estimated net cost of \$20/ac for a static groundwater depth of 10 ft and an estimated net savings of \$223/ac for a static groundwater depth of 100 ft. In contrast, for surface water at a cost of \$75/af, there is an estimated net cost of between \$458/ac for a static groundwater depth of 10 ft and \$215/ac for a static groundwater depth of 100 ft.

Figure 6-14 Estimated Difference in Operating Costs for Example 320-Acre Rice Farm with Surface Water Costs of \$5/af to \$75/af and Static Depth to Groundwater of 10 ft to 100 ft

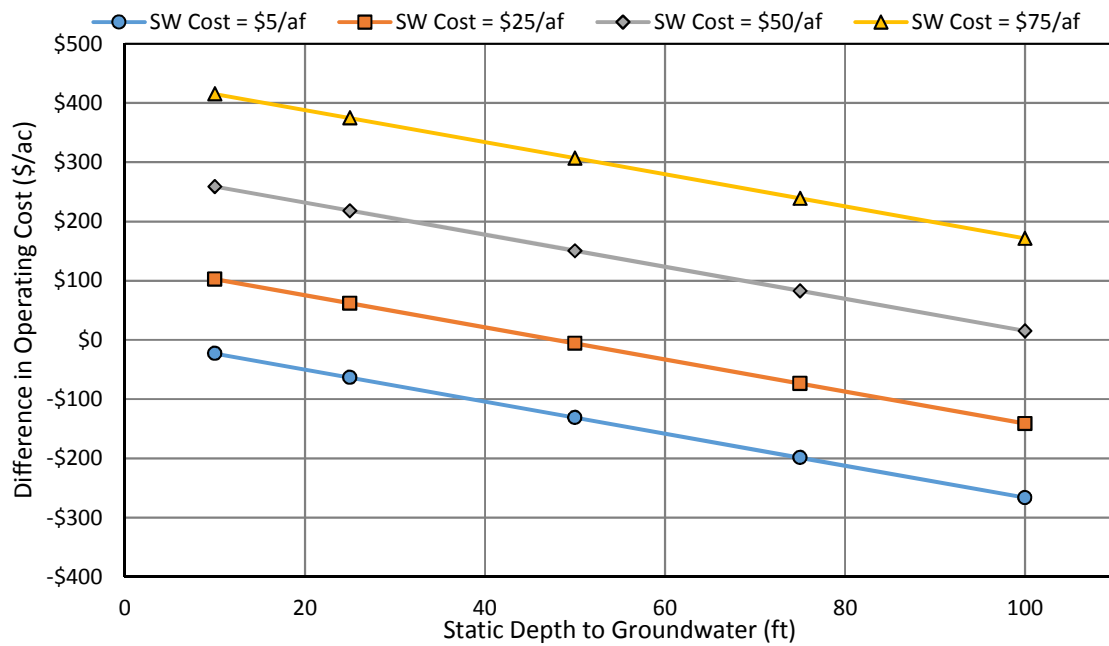
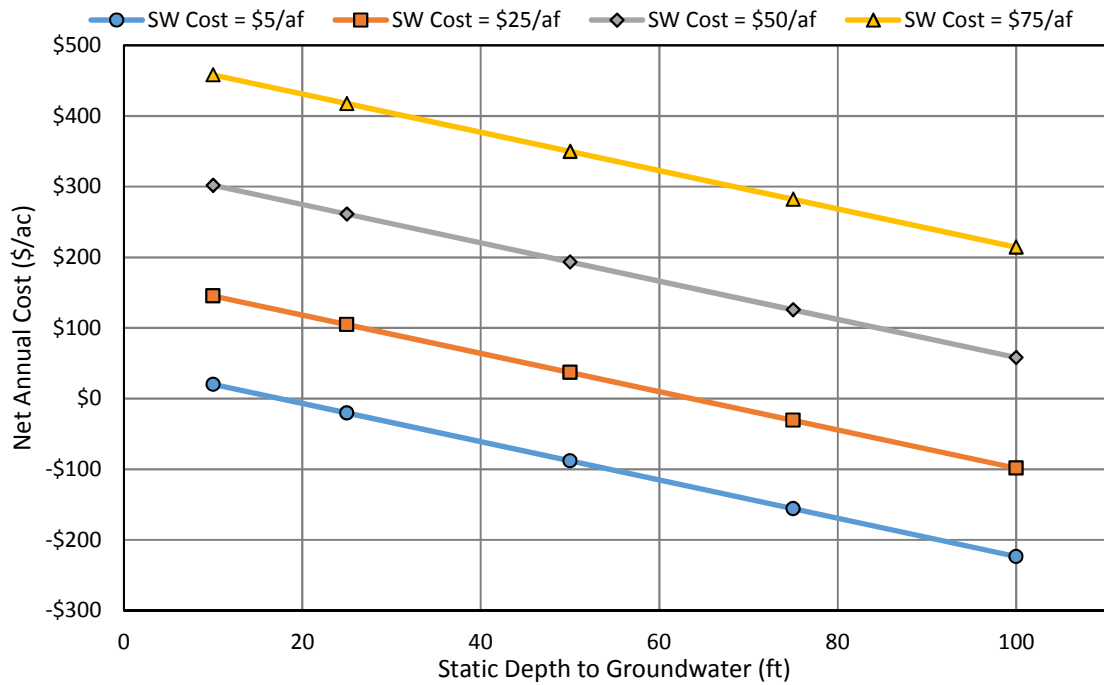

Figure 6-15 Estimated Net Annual Cost of Dual Source System for Example 320-Acre Rice Field with Surface Water Costs of \$5/af to \$75/af and Static Depth to Groundwater of 10 ft to 100 ft



6.3. Agronomic Assessment

6.3.1. Overview

While the characterization of dual source systems and associated costs focuses on key physical and operational cost differences from systems solely reliant on groundwater, this section focuses on agronomic distinctions between the single source and dual source systems that have cost and benefit or other consequences. This section has been developed based on consultation with selected growers, subject matter experts from UC Cooperative Extension, professional agronomists, irrigation suppliers, and review of pertinent literature. Primary agronomic differences between the two systems (essentially between the two water sources) that could be important to the assessment relate to the following factors:

- Flexibility
- Disease Risk
- Water Quality
- Grower Familiarity, Perceptions, and the Need for Training

A broader discussion of factors considered by growers related to water source, irrigation system type, and dual source systems is provided as Attachment A.

6.3.2. Flexibility

A primary reason that growers who have access to both surface water and groundwater prefer groundwater for permanent crops irrigated with pressurized irrigation methods is the reliability of an on-demand water source. This advantage of groundwater diminishes if surface water is on-demand during the growing season, which is generally the case in surface water supplier service areas in Butte County where fields are located along primary irrigation canals that have water throughout the irrigation season. The reliability of water is particularly important for permanent crops, which represent large, long-term investments by growers. Permanent crops also represent high value commodities for which inputs must be managed with high precision.

Reliability of water supply is also important not just seasonally or annually, but also within a given year when water might be needed on specific days (e.g. for frost protection), or to supply water during particularly dry winter and early spring months.

Within water supplier service areas, decisions to implement dual source systems require a field-specific assessment of the flexibility with which surface water can be provided with regards to the timing, rate, and duration of crop-specific irrigation needs. Programs that would supply new

surface water supplies to areas solely reliant on groundwater must also consider the flexibility with which water would be available to meet irrigation demands.

6.3.3. Disease Risk

Phytophthora (root and crown rot) is transmitted through surface water in Butte County and can result in permanent crop damage and yield reduction for fruit and nut trees. Thus, a benefit of using groundwater for orchard irrigation as compared to surface water is reduced risk of root and crown rot; however, there are several management options to prevent contact between wood and water, including:

- Planting trees on berms when surface irrigation is used
- Using stream splitters when sprinklers are used
- Keeping the tree crowns dry with physical barriers when sprinklers or surface irrigation is used
- Choosing a rootstock that is relatively tolerant of fungal disease
- Using fungicides

Despite these options, there may be a perception among many growers that phytophthora represents a serious risk with any use of surface water.

6.3.4. Water Quality

In addition to disease risk, as discussed previously, various parameters of water quality were considered, including:

- Chemical constituents
- Biological constituents
- Physical constituents
- Temperature

6.3.4.1. Chemical

Chemical constituents considered include bicarbonates, nitrate, and total dissolved solids. Bicarbonates precipitate elements such as calcium from the soil. When bicarbonates accumulate in an irrigated area, deposits form and can plug emitters in pressurized irrigation systems. Bicarbonates typically come from deep aquifers. Surface water in Butte County is unlikely to contain high bicarbonates. Thus, the use of surface water can provide a benefit to prevent clogging of pressurized systems.

Nitrate accumulates in groundwater when it leaches through the root zone on fields that have been fertilized and irrigated over a number of years, especially with high-volume systems that are not maintained or managed for maximum fertilizer use efficiency. Nitrate is generally not harmful to crops, and provides a crucial macronutrient to support crop growth. As a result, the use of groundwater with substantial nitrate concentrations can provide a benefit to growers by partially offsetting nitrogen fertilizer requirements and costs; however, nitrate concentrations in groundwater are generally low in Butte County. Thus, the use of groundwater can provide a benefit to partially offset fertilizer requirements.

Surface water in Butte County is often very pure (low total dissolved solids) because its source is mountain streams that are tributaries to the Feather and Sacramento Rivers. Growers are aware, and experts agree, that pure water (lacking salts and minerals) can impact soil quality by dispersing soil particles and decreasing infiltration on surface soils over time. This effect can be mitigated by amending irrigation water with nutrients in the form of chemical additions that improve water quality for this purpose. Growers with access to groundwater may also apply it occasionally if they observe that infiltration has been negatively impacted by pure surface water. Thus, periodic use of groundwater can provide a benefit to improve infiltration.

6.3.4.2. Biological and Physical Constituents

As discussed previously as part of the characterization of dual source systems, surface water generally requires screening and filtration to remove solids, which may include inorganic materials (sand, silt, and clay), aquatic organisms (algae, weeds, and fish), and trash (sticks, litter, etc.). These solids, other than sand in some cases, are generally not a concern when groundwater is used. Current technology is capable of removing solids from surface water for the range of pressurized systems used in Butte County. Thus, the primary considerations related to the use of surface water with regard to solids removal are the capital, operations, and maintenance costs of filtration, as described previously as part of the characterization of dual source systems.

6.3.4.3. Temperature

Temperature is a known yield reduction variable in rice production, but less is known about the impact of water temperature on orchard crops such as almonds, walnuts, and stone fruit. Groundwater is generally warmer than surface water because the source of surface water in Butte County is mountain streams typically fed by snowmelt. Warmer water temperatures are preferred for frost protection, but may promote the growth of diseases of concern in orchard crops such as some strains of *Phytophthora*. Relative to crop physiology, the small difference

between groundwater and surface water temperature is not likely to be a primary consideration for crops other than rice.

6.3.5. Grower Familiarity, Perceptions, and the Need for Training

In areas where surface water is currently available or could be made available in the future, lack of grower familiarity with dual source systems is a potentially significant barrier to the use of surface water, particularly for pressurized irrigation systems. Growers must consider the added complexity and initial costs of dual source systems, as well as factors related to flexibility, disease risk, and water quality. This effort seeks to provide information to support informed decisions by growers choosing whether to invest in the use of surface water now or in the future. The following section provides a preliminary analysis of the direct economic benefits to growers using dual systems and regional benefits to other groundwater users in Butte County in the context of reduced pumping costs and improved water supply reliability in the context of SGMA.

6.4. Economic Analysis

6.4.1. Overview

This section summarizes the analysis conducted by ERA Economics (ERA) to quantify the benefits and costs of implementing selected dual irrigation systems with the capability of relying on either surface water or groundwater in Butte County. The evaluation of the potential dual system is extended to evaluate the broader economic benefits and costs of implementing an in-lieu recharge program in Butte County for the purpose of offsetting estimated groundwater overdraft in the basin. A reconnaissance-level analysis of the economic feasibility of managing groundwater overdraft with an in-lieu recharge program is presented.

The analysis proceeds in four phases. The costs of implementing a dual system for selected fields in Butte County are presented in the initial section. This includes the net cost of the dual system after accounting for any cost savings over the variable cost of using groundwater. Next, the cost analysis is extended to evaluate the potential in-lieu program. This includes the infrastructure and operating cost for additional surface water conveyance to the fields that participate in the in-lieu program. The third phase of the analysis quantifies the field-specific and basin-wide benefits of the in-lieu program. The analysis concludes with an economic feasibility assessment (benefit-cost analysis) that compares the present value of the total benefits to the total costs of the in-lieu program to manage groundwater overdraft. A series of sensitivity analyses are presented to demonstrate the effect of uncertain cost parameters on the economic feasibility of the in-lieu program.

Specific details (e.g. location, scale, basin overdraft) of the potential in-lieu program have not been developed at this time. This analysis relies on several assumptions that are summarized under Key Assumptions at the end of this section. Important assumptions that may affect the conclusions of the analysis are discussed throughout, and a sensitivity analysis is presented so that the reader can understand the magnitude of key uncertainties. The following subsections summarize the costs and benefits, methods, assumptions, and economic analysis results.

6.4.2. Summary of In-Lieu Program Benefits and Costs

This subsection summarizes the costs and benefits of the dual system and conceptual in-lieu recharge program that were evaluated for the analysis. The net cost of the dual system to individual fields and the net benefit of the in-lieu program to Butte County are presented under the In-Lieu Program Benefit Cost Analysis subsection.

The cost of the dual system for any given field includes field-specific costs, conveyance costs, and opportunity costs for underutilized existing irrigation system capital. The following costs are calculated for this analysis:

1. The capital cost of the equipment required for the dual system at the farm
2. The variable cost of operating the surface system, net of any cost savings over the existing groundwater system
3. The capital and operating cost of conveying surface water to the fields included in the dual system
4. The cost of purchasing surface water from a willing seller
5. The opportunity cost of any capital in the existing groundwater well that is not used (or underutilized) once the dual system is implemented

The capital and operating cost of switching to a dual system on selected fields in Butte County was developed by Davids Engineering (DE). DE completed additional analysis to estimate the capital cost and operating costs for conveying water to fields that are included in the in-lieu program. The cost of purchasing additional surface water in this initial analysis is assumed to be approximately equal to current costs for water transfers within the County. ERA estimated the opportunity cost of stranded capital assets for the dual system fields. This includes the share of groundwater pumping costs that are not utilized under the dual system configuration over the remaining useful life of that existing system. The net cost per acre-foot for implementing the in-lieu program is summarized under the subsection In-Lieu Program Benefit Cost Analysis.

The economic benefits of an in-lieu recharge program to offset groundwater overdraft accrue to individual land owners who participate in the program (install a dual system), all other water users in the basin, or both. Economic benefits quantified in this analysis include:

1. The value of stable groundwater levels reflected in the avoided cost of groundwater pumping
2. The benefit of increased future water supply reliability, reflected in reduced water supply risk to growers
3. Avoided costs of fallowing (or other programs) to manage groundwater overdraft

Prior to the Sustainable Groundwater Management Act of 2014 (SGMA), the benefit of an in-lieu recharge program only included the direct benefits to an individual grower (pumping lift). Under SGMA, sustainable groundwater management is mandated for the entire basin, and projects that enable the region to satisfy SGMA provide economic benefits to all water users in the basin. For example, stabilizing groundwater levels reduces future groundwater pumping costs for agricultural, municipal, and rural residential users. The net present value of the future stream of reduced pumping cost is a direct benefit to all water users in the basin. The value of increased water supply reliability (and preservation of water rights) is another benefit to all basin irrigators. Managing groundwater helps ensure that water supply will be available in dry years to balance any surface water shortfalls. This decreases future water supply risk to farms, and provides a direct economic benefit to irrigators in the basin. Finally, the in-lieu program is an alternative groundwater management approach which is less costly than fallowing, and likely to be less costly than other alternatives (e.g. other demand management approaches) that were not evaluated in this initial study.

6.4.3. Methodology

The economic analysis includes two components: a field-level analysis of benefits and costs and a basin-wide analysis of broader in-lieu program benefits.

The field-level analysis of benefits and costs is developed in a spreadsheet that accounts for the costs and benefits of switching individual fields from groundwater-only to a dual system. The economic analysis builds on the Cost Estimation Tool developed by DE (see Section 6.2.3, Development of General Cost Estimates and Cost Estimation Tool), which identified each field, the crop grown, and cost parameters for a potential dual system. The economic benefit-cost analysis extends the field analysis to include additional economic costs (opportunity cost of stranded capital) and the total economic benefits of in-lieu recharge.

ERA calibrated an economic optimization model of agricultural production in Butte County that is used to evaluate the basin-wide economic benefits of a potential in-lieu recharge program. An economic optimization model is a framework that is able to evaluate the market (e.g. price) and resource conditions (e.g. sustainable groundwater management requirements) facing growers in the basin. The model is calibrated to current economic conditions (e.g. prices and costs) in the

basin across four subbasins (East Butte, West Butte, Vina, and Wyandotte Creek). The Butte County economic model is linked to the Cost Estimation Tool developed by DE and used to simulate the economic costs and benefits of the potential in-lieu recharge program to offset overdraft. A 25-year simulation is used (2017 – 2042) to cover full implementation of SGMA and a reasonable approximation of future benefits and costs. All monetary value streams are discounted and expressed in present value using a discount rate of 3.5 percent.

The linked field-level and optimization modeling frameworks are used to evaluate the total benefits and costs of an in-lieu recharge program. Fields that can switch to a dual system at the lowest cost are identified and included in the in-lieu program. The economic feasibility analysis compares the total costs and benefits of the in-lieu program. The analysis hinges on several critical assumptions that are summarized under section 6.6.1 Key Assumptions at the end of this section.

6.4.4. In-Lieu Program Benefit-Cost Analysis

The following section provides a more detailed summary of the costs and benefits of the dual system and potential in-lieu recharge program.

The field-level costs of the dual system include some offsetting cost savings that result from avoided variable groundwater pumping costs. It follows that the dual system cost represents the cost of the system net of these cost saving benefits for participating fields.

6.4.4.1. Costs

The costs of the in-lieu recharge program include field-specific operating, maintenance, and capital costs of the dual system, in addition to the capital, operating, and maintenance cost of conveying surface water to those fields. The Cost Estimation Tool summarizes the capital, operating, and maintenance costs of dual systems for fields in Butte County that are currently irrigating with groundwater. DE completed additional analysis to estimate the incremental connection cost based on the lift and proximity to the nearest surface water source for each field. The incremental conveyance cost assumes approximately 2,000-acre blocks are connected to achieve reasonable scale economies. The assumption of a 2,000-acre block minimum scale should be reevaluated in future iterations of this analysis. If smaller, non-contiguous parcels are connected this will increase the conveyance costs of the in-lieu program.

Growers that switch to a dual system will underutilize the existing groundwater system on the field. The opportunity cost of underutilized capital is defined as the present value of the unused share of groundwater pumping fixed costs over the remaining useful life of the system. On some

fields the groundwater system cost is negligible because the system exceeds, or is near, the end of its productive life, and on other fields with a newer well this cost could be substantial. Given the uncertainty in this parameter, ERA assessed this opportunity cost at 50 percent of the fixed cost of the groundwater system (amortized over the remaining useful life, expressed in present value).

The total annual cost of the in-lieu program is the sum the incremental capital cost of connecting each field to the dual system, the additional costs (or savings) generated by switching from groundwater to the dual system, the connection and conveyance cost to serve the fields from the nearest canal, the stranded capital cost of unused groundwater pumping capacity, and the cost purchasing additional surface water supplies. Table 6-9 summarizes each cost component, whether it is a fixed or variable cost, and lists some example cost components. The net cost of the in-lieu program per acre-foot is calculated as the sum of the variable costs plus the amortized cost of the capital components.

Table 6-9 Dual System and In-Lieu Program Cost Components

Item	Type	Example Components
Field connection	Capital	Filters, pump, and on-farm system
Conveyance	Capital	Turnout, pipe, and pump
Conveyance	Variable	Pumping cost
Irrigation cost	Variable	Net cost of surface water minus 50% of groundwater variable cost
Water supply	Variable	Cost of additional water supply

The total cost of the dual system is calculated for each field in Butte County that is currently irrigating with groundwater using the Cost Estimation Tool developed by DE. Fields are then ranked from lowest to highest net cost to evaluate the marginal cost of the in-lieu program. Figure 6-16 illustrates the change in the in-lieu cost per acre-foot as the in-lieu program is expanded up to 20,000 AF in each subbasin. As expected, the cost per acre-foot differs between regions and increases as the total quantity of in-lieu water supply increases. The Wyandotte Creek subbasin shows the highest cost per acre foot, largely driven by differences in conveyance costs to fields in this subbasin. Two important assumptions underlie the marginal cost calculations. First, sufficient surface water can be secured by project proponents to serve the fields that participate in the in-lieu program, and the additional surface water has the same cost as existing surface water supplies. Second, the in-lieu program conveyance and operating costs assume that contiguous 2,000-acre blocks are added to the program. If surface water supplies are more expensive, or smaller parcels are connected, the marginal cost of the program will increase.

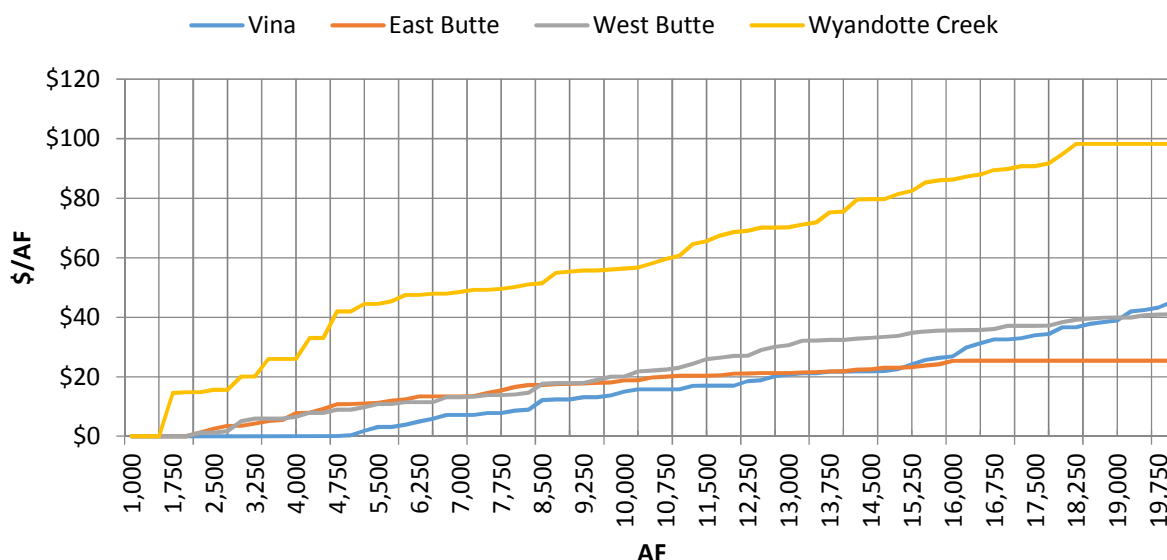
Figure 6-16 Dual System Marginal Cost by Butte County Subbasin

The scale of the in-lieu program could be determined based on various criteria, including minimizing costs, maximizing existing surface water use, or maximizing benefits based on other sustainability criteria. In this reconnaissance-level analysis, the scale of the in-lieu program is determined by a preliminary estimate of potential long-term overdraft in each subbasin. The analysis assumes that the in-lieu program would supply 50% of the overall annual crop water requirements. The cost-minimizing set of fields required to offset the overdraft in each basin are selected. The analysis does not consider the spatial location of each field, and thus is likely to understate the conveyance costs to these fields. The cost-minimizing combination of fields considering spatial location in each subbasin can be evaluated in future analyses.

Table 6-10 summarizes the preliminary estimate of average annual overdraft in each subbasin and the cost-minimizing number of fields that must enter the in-lieu program to fully offset the overdraft in each subbasin. The average annual overdraft ranges from less than 1,000 acre-feet (AF) in Wyandotte Creek to just less than 5,000 AF in East Butte³². By selecting the fields that have the lowest cost of switching to a dual system, the in-lieu program can fully offset the groundwater overdraft at a marginal cost of \$17.50 to \$28 per AF. The total cost of the in-lieu program can be approximated as the product of the overdraft quantity and the appropriate marginal cost per acre foot, or approximately \$330,000 per year.

³² These preliminary estimates are subject to substantial uncertainty and could be refined in the future as part of Groundwater Sustainability Plan (GSP) development for each subbasin.

Table 6-10 Potential In-Lieu Program Costs

	East Butte	West Butte	Wyandotte Creek	Vina
Average overdraft (AF)	4,926	4,846	710	4,844
In-lieu area (acres)	3,794	3,868	284	3,531
Number of fields	44	27	3	33
In-lieu marginal cost per AF	\$23.40	\$22.36	\$28.03	\$17.55

The analysis finds that the current estimated groundwater overdraft can be offset by an in-lieu recharge program at a reasonable marginal cost per acre-foot. In addition to the conveyance cost and surface water availability assumptions described previously, this result is driven by two additional factors. First, the analysis by DE shows that the variable cost of surface water is significantly less than the variable cost of pumping groundwater. Even when the additional capital costs required for the dual system are included, the total dual system costs are small in comparison to the groundwater pumping cost. It follows that the per acre-foot cost of surface water is generally less than groundwater, assuming that additional surface water supplies are readily available at a cost that is comparable to current water charges. Second, the estimated overdraft in each of the four regions is relatively small, less than 5 percent of average annual irrigation water use in all regions. The incremental acreage that must be included in the in-lieu program to offset this modest overdraft is also small, which means that the in-lieu program can be targeted to the lowest cost fields shown in Figure 6-16. A wider dispersion of fields would increase the conveyance cost of the in-lieu program, and increase the overall cost.

6.4.4.2. Benefits

Most of the field-level cost saving that a dual system would provide are included in the net costs summarized in Table 6-10, and described previously under the section Development of General Cost Estimates and Cost Estimation Tool. The field-level and regional economic benefits of the in-lieu recharge program that are not already accounted for in the dual system net cost can be broken down into three key components:

1. Reduced future groundwater pumping costs
2. Reduced water supply risk
3. Direct on-farm benefits

The on-farm cost analysis of the dual system presented in the previous subsection has characterized the on-farm benefits and costs. As such, any on-farm benefits are included in the net cost of the system shown in the previous section. The county-wide benefits of reduced

pumping costs and water supply reliability are presented in this subsection. In addition, an alternative cost analysis of cropland fallowing to offset overdraft through reduced crop water demand is presented. The avoided cost of fallowing is not a benefit of the in-lieu program (it would be double-counting), but it is presented as an alternative management approach and used to demonstrate the sensitivity of the in-lieu program economic feasibility analysis to other groundwater management options.

6.4.4.3. Avoided Costs of Crop Fallowing

One alternative to an in-lieu program to offset groundwater overdraft is to fallow sufficient cropland to reduce groundwater pumping for crop water demand to bring each subbasin into balance. In practice, there are likely to be alternative projects and management actions in Butte County that may have a lower cost. These alternative management actions and projects have not been specified at this time. This initial analysis estimates the marginal cost of demand management through fallowing as an alternative to the in-lieu program.

The fallowing cost was estimated using the economic model of Butte County crop production. The average annual overdraft (in acre-feet) for each region is offset by reducing crop water demand by an equivalent amount over the 25-year simulation period. The average annual fallowing costs are expressed in terms of the farm profit net of variable costs per acre foot. Table 6-11 summarizes the results of the analysis by subbasin. The cost of a fallowing program per acre-foot ranges from \$123 in West Butte to \$490 per acre-foot in Vina. Regional differences in the marginal cost of a fallowing program are jointly determined by the value of the underlying crop mix in the region, and the total overdraft in the subbasin. Rice and other field crops would comprise the majority of fallowed acreage in each region, followed by orchards as needed to prevent overdraft.

Table 6-11 Potential In-Lieu Program Avoided Fallowing Costs

	East Butte	West Butte	Wyandotte Creek	Vina
Average overdraft (AF)	4,926	4,846	710	4,844
Groundwater reduction (%)	2%	4%	2%	6%
Acres fallow	1,983	1,951	286	2,023
Fallowing marginal cost per AF	\$126	\$123	\$126	\$490

The analysis finds that the marginal cost of a fallowing program (shown in Table 6-11) to offset overdraft in each subbasin greatly exceeds the cost of the in-lieu program (shown in Table 6-10).

The total fallowing cost equals \$3.68 million per year. The costs of fallowing are sensitive to the amount of overdraft required. Sensitivity analysis of the fallowing cost shows that if the overdraft increases by 50%, the fallowing cost goes up by 53%. However, when the overdraft is reduced by 50% the fallowing cost only goes down by 33%.

Reductions in crop production caused by a fallowing demand management program have ripple effects in other sectors of the regional economy (so-called “third-party” impacts). Fields that are not farmed do not provide direct jobs at the farm or in the regional economy through purchases of inputs and expenditures at local businesses. For example, growers purchase inputs from local suppliers and contractors. Crops are harvested, processed, and transported by companies across the state, and employees in all of these businesses spend income in the local economy. Every dollar decrease in gross farm revenues causes additional losses in other sectors of the economy. Third-party impacts of this type of demand management program should be carefully evaluated, and included as an indirect cost of the program.

6.4.4.4. Pumping Cost Savings from Stabilizing Groundwater Levels

The current rate of overdraft in Butte County subbasins is causing groundwater levels to drop in some areas. As groundwater levels drop, the marginal energy cost lift and pressurize groundwater for irrigation increases, which has a negative effect on net farm income. Stabilizing the subbasin overdraft through the in-lieu program will reduce future pumping costs for all irrigators in the subbasin. These benefits would start with the implementation of the in-lieu program (level is stabilized) and accrue over an infinite future horizon. The present value of this benefit stream is calculated using a discount rate of 3.5 percent.

The Cost Estimation Tool is used to calculate the average variable pumping cost increases by \$0.86 per acre foot for every additional foot of lift. A 2008 – 2016 analysis of groundwater level trends for Butte County subbasins shows that the average annual decline in groundwater levels varied from 0.1 feet per year in Wyandotte creek to 0.5 feet per year in West Butte and Vina. The annual cost of falling groundwater levels in each subbasin is calculated based on current groundwater use. The present value of this assumed infinite stream of benefits³³ is calculated using a discount rate of 3.5 percent. Table 6-12 summarizes the results of the analysis. The total present value of the groundwater level stabilization benefit equals \$3.2 million across the four subbasins.

³³ In other words, for purposes of this analysis, it is assumed that average annual groundwater level declines between 2008 and 2016 are representative of potential long-term trends under baseline conditions. This assumption can be re-evaluated as part of GSP development for each subbasin.

Table 6-12 In-Lieu Program Stabilization Benefits

	East Butte	West Butte	Wyandotte Creek	Vina
Average elevation change (ft/year)	-0.2	-0.5	-0.1	-0.5
Pumping cost (\$ per AF per ft lift)	\$0.86	\$0.86	\$0.86	\$0.86
Average annual pumping (AF/yr)	119,500	115,800	50,700	88,300
Present value benefits (\$)	\$585,000	\$1,418,000	\$124,000	\$1,081,000

6.4.4.5. Benefit of Water Risk Reduction from Stabilizing Groundwater Levels

An important and often overlooked economic benefit of groundwater stabilization is the value of reduced risks from uncertain future water supplies (e.g. protecting water rights or offsetting water shortage). Stabilizing groundwater supply will reduce overall basin water use and/or increase overall irrigation water cost. However, the tradeoff is that water supply is more certain because groundwater supply is managed and available at a given cost. Since water supply is a necessary input to farming and typically comprises a large share of variable production costs, there is a corresponding benefit to net farm income from this improved water reliability. Intuitively, the value of stable water supply is equal to the difference between expected annual farm revenues with variable water supply and the annual farm revenue that would be generated with a known, stable water supply.

The economic value of improved water supply reliability can be assessed across an entire region or for an individual farm. This reconnaissance-level analysis establishes the value of improved water supply reliability under the in-lieu program at the subbasin scale. The Department of Water Resources Sacramento River Index (Figure 6-17) is used to approximate regional water supply variability in Butte County, and this is assumed constant across all four subbasins. The index is normalized to 1, reflecting the average water supply over the entire 107-year index. The annual variability over the 107-year index equals 0.122 (or, approximately 12.2% using the normalized index). In practice, surface water supply in Butte County has historically been more stable than the Sacramento River Index due to senior surface water rights.

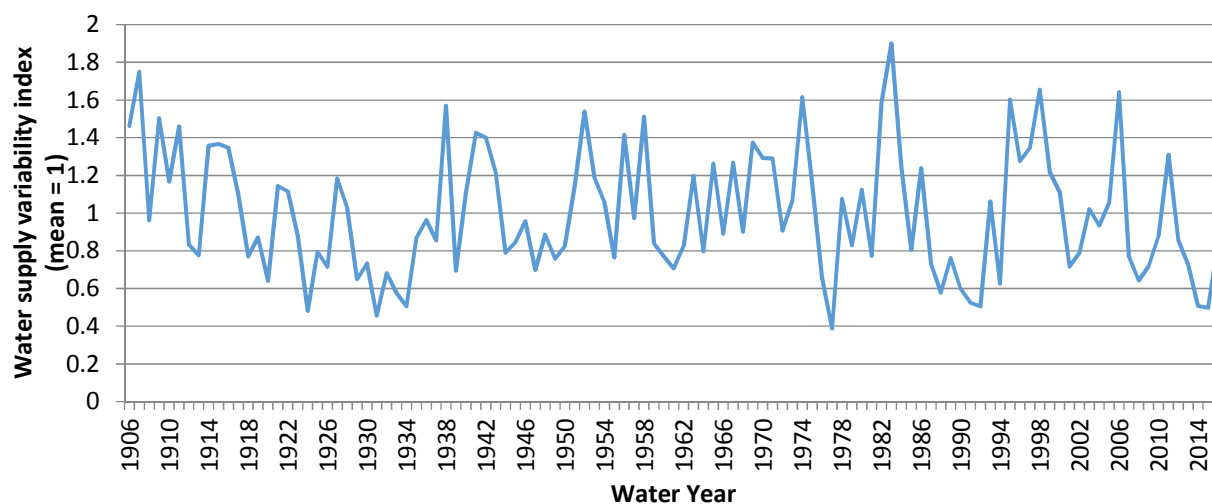
Figure 6-17 Normalized Sacramento River Water Supply Index (Department of Water Resources)

The annual water supply variability is used to estimate the economic value of improved reliability in future water supply by evaluating the mix and value of crops produced under a range of water supply conditions. Gross farm revenues under a range of water supply conditions are evaluated using the economic model of Butte County agriculture. The model is parametrically run up to a 55 percent reduction in total water supply to establish the relationship between regional farm revenues and total water supply.

Figure 6-18 illustrates the results of this simulation, showing total gross farm revenues under varying water supply availability. It represents the change in regional farm revenues as the region adjusts to water supply cuts. The adjustments include crop switching, fallowing, limited deficit irrigation, and other adjustments in farm management practices. The cost of reduced water supply—reflected in the value of farm production—increases non-linearly with the level of the shortage.

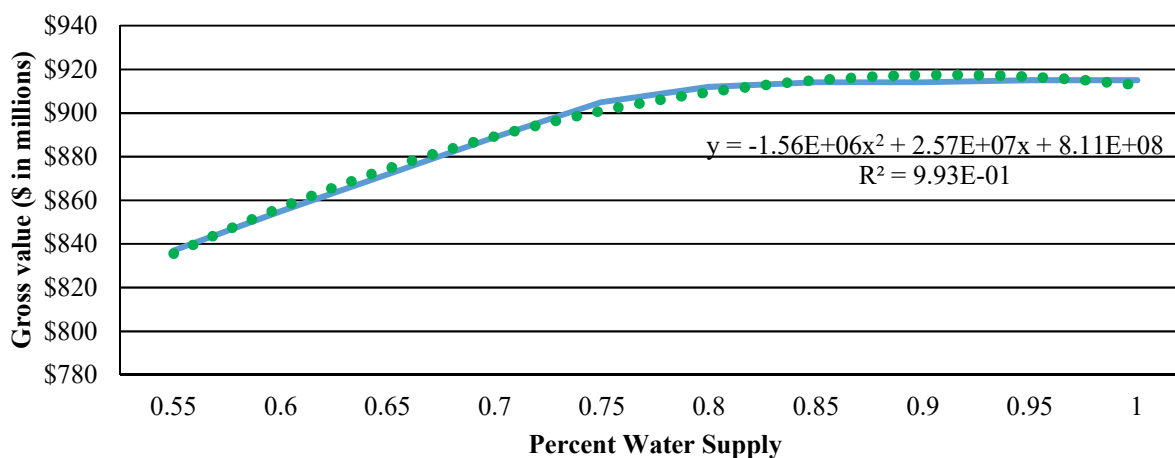
Figure 6-18 Water Risk Offset Value Revenue Function

A non-linear regression is used to fit a revenue function that represents this relationship between gross agricultural revenues and water supply. This function is shown as the dotted green line in Figure 6-18. Defining $f(x)$ as regional gross farm revenues and x as the percent water supply available, the equation for the revenue function $f(x)$ is:

$$f(x) = 8.11e08 + 2.57e07x + 1.56e06x^2$$

The water supply variability illustrated in Figure 2 is combined with the aggregate measure of agricultural revenues under varying water supply presented in Figure 3 to calculate the economic value of improved water supply reliability. The value of stable water supply is equal to the difference between expected annual farm revenues with variable water supply and the annual farm revenue that would be generated with a known, stable water supply. Mathematically, the risk benefit (RB) of stable water supply is defined as the difference between farm revenue under a stable, known water supply, $f(\bar{x})$, and the expected revenues under uncertain water supply, $E\{f(x)\}$:

$$RB = f(\bar{x}) - E\{f(x)\}$$

The underlying intuition behind the economic jargon and mathematics is that irrigators benefit from a stable, reliable water supply, even when the stable water is only available at a higher cost. This is calculated on a basin-wide basis using the formula above. The present value of the Butte County risk offset benefits of the in-lieu program equal \$244,380 per year. This is the total regional benefit that the in-lieu recharge program would provide in terms of reduced water supply risk in the future (expressed in present value).

6.5. In-Lieu Program Economic Feasibility

A project is economically feasible if the benefits of the project are greater than the costs over the economic life of the project, and there is no lower-cost way to achieve the same level of benefits. Economic feasibility is typically evaluated using a benefit-cost analysis, where the present value of the total project benefits is compared to the total project costs.

Table 6-13 summarizes the total benefits and costs of the in-lieu program. The average annual benefits include \$3.2 million in avoided pumping cost savings and \$244,000 in risk reduction value, for a total benefit of \$3.4 million. The program costs equal \$330,000. The benefit cost ratio is greater than 10, and the in-lieu recharge program is considered economically feasible at this level of preliminary analysis based on the key assumption described below.

Table 6-13 Potential In-Lieu Program Benefit-Cost Summary

Annual benefits	
Pumping cost savings	\$3,208,119
Risk reduction value	\$244,380
Total benefits	\$3,452,000
Total costs	\$328,500
BC Ratio	10.5

This reconnaissance-level analysis shows that the in-lieu program is an economically feasible way to stabilize groundwater overdraft in Butte County. Throughout the analysis it has been noted where the costs of the program are understated. However, the remarkably high benefit cost ratio shows that there is a very substantial margin which is likely to be more than enough to cover any downward bias in the estimated costs of the program.

6.5.1. Sensitivity Analysis

A series of sensitivity analyses were conducted to evaluate the effect of important assumptions on the economic feasibility of the in-lieu program. The average annual overdraft in each subbasin was evaluated over a range of plus or minus 50% of the baseline value:

1. The baseline scenario (presented above), using average annual overdraft parameters.
2. A +50% scenario where the average annual overdraft in all regions is increased by 50 percent over the baseline scenario
3. A -50% scenario where the average annual overdraft in all regions is reduced by 50 percent over the baseline scenario

Under each of the sensitivity scenarios, the analysis described previously was re-run to evaluate the costs and benefits of the in-lieu program. Table 6-14 summarizes the baseline and sensitivity analyses in terms of the average annual overdraft and effective cost of the in-lieu program per acre-foot.

Table 6-14 Potential In-Lieu Program Sensitivity Analysis Summary

Region	Base		+50% Overdraft		-50% Overdraft	
	Overdraft	Cost per AF	Overdraft	Cost per AF	Overdraft	Cost per AF
East Butte	4,926	\$23.40	7,389	\$24.26	2,463	\$11.01
West Butte	4,846	\$22.36	7,269	\$33.70	2,423	\$10.79
Wyandotte Creek	710	\$28.03	1,065	\$32.98	355	\$15.59
Vina	4,844	\$17.55	7,266	\$21.82	2,422	\$3.13

The economic risk reduction value benefit is the same under both sensitivity analyses because groundwater elevations and water supply reliability is stabilized, by definition, under the in-lieu program. The pumping cost savings is linearly related to the average annual change in groundwater levels since the annual change in groundwater levels varies linearly with the average annual change in groundwater overdraft. It follows that the future stream of pumping cost savings increases/decreases by +/- 50% under each sensitivity scenario. The field-level cost savings (benefits) of the dual system are already reflected in the net cost per acre foot, as shown in Table 6-13. Table 6-15 summarizes the total costs and benefits of the in-lieu program under the high, low, and average overdraft scenarios.

Table 6-15 Potential In-Lieu Program Benefit-Cost Sensitivity Analysis

Annual benefits	Baseline	+50% Overdraft	-50% Overdraft
Pumping cost savings	\$3,208,119	\$4,812,178	\$1,604,059
Risk reduction value	\$244,380	\$244,380	\$244,380
Total benefits	\$3,452,499	\$5,056,558	\$1,848,439
Total costs	\$328,539	\$617,890	\$66,377
BC Ratio	10.5	8.2	27.8

The groundwater overdraft sensitivity analysis—holding all other assumptions constant—finds that the in-lieu program would be economically feasible even if overdraft is double the baseline level used in the initial analysis. This result is expected since the groundwater overdraft is a relatively small share of the total basin irrigation water use.

A second sensitivity analysis was conducted to identify the cost threshold at which the demand management through cropland fallowing program would be lower cost (and thus result in a higher benefit-cost ratio) than the in-lieu program. There are several cost parameters that could be varied to investigate this threshold. The purchase cost of additional surface water supplies was selected for the sensitivity analysis. The baseline analysis assumes that the additional surface water supplies required to serve the fields that participate in the in-lieu program are available at approximately the same cost as current water supply for surface water transfers within the County. If surface water is not available in sufficient quantities, additional supplies would need to be purchased on the market or through agreements with partner agencies. If additional water supply costs are too expensive, other alternatives (such as fallowing) would be a lower cost option for managing groundwater overdraft. The surface water costs were increased up until the point that the net cost of the in-lieu program per acre-foot (Table 6-16) equals the fallowing program cost (Table 6-11). The maximum cost per acre-foot of additional surface water before the fallowing program becomes a lower cost option than the in-lieu program ranges from \$100 per acre-foot in West Butte to \$473 per acre foot in Vina³⁴. If additional surface water can be purchased for less than these values, the in-lieu program will still satisfy economic feasibility at the current level of evaluation.

Table 6-16 Potential In-Lieu Program Water Purchase Cost Sensitivity Analysis

Region	Overdraft	In-Lieu Cost per AF	Maximum Additional Water Cost
East Butte	4,926	\$23.40	\$107
West Butte	4,846	\$22.36	\$100
Wyandotte Creek	710	\$28.03	\$138
Vina	4,844	\$17.55	\$473

Two sensitivity analyses show that the estimated level of groundwater overdraft and the surface water purchase costs do not change the in-lieu program economic feasibility. The latter analysis of surface water purchase costs could equivalently be interpreted as additional costs (e.g. conveyance, operating costs) of the in-lieu program that is understated in the analysis. Both sensitivity analyses show that the in-lieu program is economically feasible over a wide range of costs, and estimated overdraft levels.

³⁴ This is the *additional* cost over the current cost of water in Butte County.

6.6. Summary

The analysis finds that the benefits of in-lieu recharge are greater than the cost under a range of overdraft estimates. In addition, the project is economically feasible if surface water can be purchased³⁵ for \$100 to \$473 per acre-foot, depending on the subbasin. The intuition behind this result is the difference in the variable costs of surface water supplies versus groundwater pumping and the moderate level of overdraft that can be offset by picking a set of low cost fields for a dual system. In addition, groundwater elevations may be declining at a rate of 0.1 to 0.5 feet per year, which provides significant future pumping cost savings, and is surprising given the current level of overdraft.

The analysis should be carefully interpreted within the context of the assumptions that have been described throughout. As in-lieu recharge program alternatives are developed, the analysis can be refined to reflect these new parameters and the reconnaissance-level economic feasibility analysis can be updated.

6.6.1. Key Assumptions

The analysis relies on a series of important assumptions. The details of a potential in-lieu program have not been developed at this time, the basin water balance is still uncertain, and preparation of a GSP to satisfy SGMA is being initiated. The following assumptions apply to the analysis:

1. It is assumed that SGMA will require stabilizing groundwater overdraft by 2040 in the basin.
 - a. The analysis considers a 25-year (2017-2042) window to cover full implementation of SGMA requirements. Future surface water supply availability is based on the historical average and does not account for any climate change effects or additional restrictions.
 - b. The in-lieu recharge program and a fallowing demand management program are evaluated, other options are not considered in this initial analysis.
 - c. An alternative cost to offsetting overdraft is fallowing crop land in a sufficient amount to balance the average groundwater overdraft. This alternative approach results in substantial costs per acre foot, and it is likely there are other lower-cost options.
2. The basin groundwater overdraft is approximated using preliminary estimates of storage changes based on historical observed groundwater levels.

³⁵ Equivalently, if the total cost estimates for the dual system are no greater than this amount.

- a. A 9-year (2008 – 2016) time series is used to establish average annual overdraft (af/year) and average annual change in pumping lift (ft/year).
 - b. The analysis is conducted for four subbasins: East Butte, West Butte, Vina, and Wyandotte Creek.
 - c. The analysis relies on the professional judgment of DE and Butte County staff for reasonable groundwater storage parameters.
3. All costs used in the analysis are provided in the Cost Estimation Tool.
- a. The dual system costs show the gross and net cost of the surface system in comparison to the current groundwater system for each field.
 - b. Conveyance costs are approximated by field based on the distance to the nearest surface water source and the elevation of the field above that source. The per-acre (or per acre-foot) capital cost of building infrastructure to serve blocks of fields with the in-lieu surface water varies by the total scale. In a preliminary analysis, DE found that 2,000-acre blocks approximate a minimum feasible unit. The conveyance costs used in this analysis reflect the incremental per acre cost for each additional 2,000 acres. In practice, the economic analysis considers a parcel-by-parcel allocation, and as such underestimates the total capital cost.
 - c. The opportunity cost of underutilized groundwater system capital is set equal to 50 percent of the fixed cost of the groundwater system, amortized over the remaining useful life.
 - d. Cost estimates represent costs to construct and operate dual systems, including conveyance, but do not include additional costs for planning, design, permitting, legal costs, etc.
4. The economic analysis of basin-wide benefits is defined for the East Butte, West Butte, Vina, and Wyandotte Creek subbasins in Butte County
- a. In practice, there is variability within these regions that would affect the field-specific benefits and costs of an in-lieu program that should be considered carefully in future analyses.
 - b. The risk reduction benefit of an in-lieu recharge program assumes that no other actions are taken to offset overdraft and that SGMA compliance is mandatory (and can be expressed solely in terms of stabilizing groundwater). In addition, the analysis assumes that the basins will be able to overdraft groundwater in dry years (when the economic value is increased) so long as it is replenished in subsequent wet years.
 - c. The basin-wide benefits of groundwater level stabilization are based on a linear extrapolation of the 2008 – 2016 average annual change provided by DE. This implicitly assumes there is no change in climate, land use or other factors that would affect subbasin water availability.

- d. It is assumed that the expansion of additional surface water supply will cost no more than the current rates charged for in-county transfers.

It is important to note that the DE cost analysis shows many fields in which the variable cost of using groundwater exceeds the variable and conversion costs of using surface water. It is difficult to reconcile this with the many growers that are using the higher cost groundwater. Even when the connection costs of using surface water are included, in many cases the overall conversion cost is negative. The widespread use of groundwater in these cases suggests that surface water is not available due to legal or other constraints and/or growers perceive that there are additional benefits from groundwater use that are not captured in the cost accounting exercise. Land IQ has summarized some of these benefits including reduced filtration, pathogen mitigation, and reduced operating and maintenance costs. This may also be because some fields are not physically able to connect to the surface water system. It follows that the analysis may underestimate the net cost of dual system conversion by understating these groundwater benefits.

Appendix 7-E
Grower Education Relating to On-Farm Practices for
Sustainable Groundwater Management: Introduction and
Topics for Grower Workshops

This page intentionally left blank.

Grower Education Relating to On-Farm Practices for Sustainable Groundwater Management: Introduction and Topics for Grower Workshops

The following sections introduce the connections between on-farm practices and groundwater sustainability. These sections help to frame specific on-farm management actions discussed in the GSP that support sustainable groundwater management, while also outlining topics for educational workshops that the GSAs will implement as a management action.

The management action the GSAs plan to implement is described in the GSP, following this discussion of the connections between on-farm practices and groundwater sustainability.

The on-farm - groundwater management nexus

Groundwater sustainability is inextricably connected to the on-farm water management decisions that growers make. The aquifers in which groundwater is stored and transmitted are dynamic systems that are directly impacted by conditions on the land surface. The water sources that growers use, the irrigation practices they apply, and the many other agronomic decisions they make can have impacts on groundwater quantity and quality.

Groundwater pumping is a major outflow from the groundwater system that is driven and controlled largely by water demand on the land surface. The depths and locations of wells affect not only how water is extracted, but also how groundwater flows throughout the rest of the aquifer. Deep percolation of irrigation water and precipitation from the surface is a significant contributor to groundwater recharge in the Subbasin. Like groundwater pumping, the location and timing of deep percolation impacts flows throughout the aquifer.

The on-farm – groundwater management nexus is central to achieving and maintaining groundwater sustainability, as envisioned under the Sustainable Groundwater Management Act (SGMA). Grower education on this topic presents a high-impact opportunity for promoting sustainability through better-informed, on-the-ground water management across the Subbasin.

Source of water to wells

Historically, aquifer storage was full, and groundwater inflows (recharge) were predominantly balanced by groundwater outflows (discharge) to streams and evapotranspiration from vegetation with access to shallow groundwater or water near the land surface. Over the last 100 years, pumping has added an additional outflow from the system. Therefore, it is critical to first understand the impacts of additional pumping on groundwater systems. When considering the role of groundwater pumping in groundwater management, it is important to recognize that:

- All water pumped from wells is balanced by some process elsewhere in the groundwater system. Groundwater pumping always reduces the volume of groundwater in storage, especially during the early stages of pumping. This reduction in volume is referred to as the “cone of depression.”

- As the cone of depression expands, it can eventually cause (1) an increase in recharge from streams or subsurface inflows from adjacent areas, (2) a decrease in discharge to nearby streams, (3) depletion of nearby stream flows (increased stream losses), or a combination of these processes.
- It takes time (months to centuries) for this reduction in groundwater storage around the pump (cone of depression) to reach areas of recharge and discharge.
- A new balance in the aquifer can only be reached when pumping is balanced by the sum of increased recharge and reduced discharge, referred to as “capture.”

The aquifer response to pumping is ultimately influenced by where pumping occurs within the physical and structural composition of the aquifer, and where pumping occurs relative to groundwater recharge or discharge areas. Coordinated timing of pumping schedules may help to address local, short-term groundwater decline in areas where significant pumping occurs; however, aquifer responses to groundwater pumping typically occur over longer time frames and are generally impacted more by long-term trends in groundwater pumping.

All these factors are important to consider when planning for groundwater sustainability. Additional considerations about the source of water derived from wells and essential factors that govern the aquifer response to pumping are described by Theis (1940), Bredehoeft et al. (1982), Leake (2011), and Barlow et al. (2018).

Capture and sustainability

Under SGMA, GSAs must develop an implementation plan to achieve groundwater sustainability within 20 years of submitting their completed GSPs. While the precise criteria that define sustainability are described in each GSP, groundwater sustainability generally results from a long-term balance between inflows to and outflows from the groundwater system, and culminates in the absence of adverse, undesirable results of chronic groundwater level decline and groundwater storage reduction.

Achieving groundwater sustainability generally requires that rates of groundwater outflow (discharge) be decreased and/or that rates of groundwater inflow (recharge) be increased. Understanding the hydrologic “capture” of water in an aquifer is indelibly linked to groundwater sustainability. In a water transport context, hydrologic capture refers to the spatial flow of groundwater through an aquifer that is ultimately pumped from a well. Depending on the well location and characteristics, groundwater pumping may capture water recharged from irrigation, water that otherwise would have discharged to streams or groundwater dependent ecosystems, and/or water leaking from streams. Additional information about hydrologic capture is described by Theis (1940), Bredehoeft et al. (1982), Leake (2011), and Barlow et al. (2018).

Importance of surface water for groundwater sustainability

Surface water availability and use also plays an important role in achieving groundwater sustainability. Using surface water for irrigation reduces groundwater pumping, providing “in-lieu” groundwater recharge benefits to the aquifer. Surface water also supplies direct groundwater recharge through seepage from streams, canals, and recharge ponds and through deep percolation of applied irrigation water. All groundwater was surface water at some point in time.

Essential water “use” terminologies

This section defines and describes key terms that are used in the discussion of groundwater sustainability.

Consumptive vs. non-consumptive

When water is diverted or pumped to irrigate crops, not all of that water will be consumed or made unavailable for reuse. Some water percolates through the soil and eventually reaches the groundwater system, and some water may drain or spill from fields and canals into downstream waterways.

Consumptive use refers to “that part of water withdrawn that is evaporated, transpired, incorporated into products or crops, consumed by humans or livestock, or otherwise removed from the immediate water environment” (ASCE, 2016). At the subbasin-scale, water that is consumptively used is effectively removed from the subbasin and becomes unavailable for direct or indirect reuse. The majority of consumptive use typically occurs through transpiration (T) from plants and evaporation from wet soil and open water surfaces (E), while a much smaller amount of water is typically stored in harvested crop products. For this reason, “consumptive use” is sometimes used interchangeably with the sum of evaporation and transpiration collectively referred to as evapotranspiration (ET) when discussing water and groundwater management. Consumptive use is a fundamental part of the hydrologic cycle and is a major focus in both on-farm and regional water management planning.

Non-consumptive use refers to “that part of water withdrawn that is not evaporated, transpired, incorporated into products or crops, consumed by humans or livestock, or otherwise removed from the immediate water environment” (ASCE, 2016). Non-consumptive use encompasses other water uses that do not result in water being removed from a system, allowing that water to be reused directly or indirectly elsewhere in the system. Water that is “lost” to deep percolation and seepage, for instance, recharges the groundwater system and is eventually available for reuse through groundwater pumping. Water that is “lost” through return flows and spillage to downstream waterways is also eventually available for reuse by agricultural, urban, and environmental water users who draw from that water for their own supply downstream. Therefore, water that is not consumed is generally not “lost” and using such terms can be misleading.

Beneficial vs. non-beneficial water use

Water use can be classified as beneficial if there are economic, social, or environmental benefits to how that water is used, or non-beneficial if there are no direct economic, social, or environmental benefits (ASCE, 2016).

Beneficial use refers to the functional, productive purpose that water is used to support. The SGMA regulations require that GSAs consider the interests of all beneficial uses and users of groundwater, including, but not limited to: agricultural users, domestic well owners, municipal well operators, public water systems, environmental users, surface water users (if there is a hydrologic connection between surface and groundwater bodies), and the specific communities within each category. Some beneficial use extracts water, for example water that is pumped for domestic or irrigation supply. Other beneficial uses are non-extractive, such as water that is percolated for groundwater storage to prevent subsidence or to support groundwater-dependent ecosystems. In regard to consumptive use, beneficial use includes all water that is consumed through ET or that is incorporated into crop products. This water directly supports crop production and the economic return of the crop product.

Non-beneficial use refers to all other water that is lost without direct beneficial purpose within the system. An example is evaporation from canals and reservoirs, which is lost to the atmosphere and is not directly used to serve a beneficial purpose within the subbasin.

The concepts of beneficial and non-beneficial use are especially important as they relate to managing consumptive use. For example, if consumptive use needs to be reduced to achieve groundwater sustainability, attempts should be made to first reduce non-beneficial consumptive uses. The concept of “water productivity” can also be useful for comparing the relative magnitude of benefits across various beneficial uses. Water productivity metrics may be based on an economic indicator (e.g. net return in dollars per acre-foot of water used), a caloric product (calories of agricultural product per acre-foot of water used), or any other indicator of interest.

Non-consumptive - Recoverable vs. non-recoverable

Non-consumptive use, or water that is diverted or pumped but not consumptively used, can often be recovered for other beneficial uses through pumping or downstream diversion. This “recoverable” water, or “recoverable loss,” includes deep percolation or seepage of surface water and rainfall that recharges the groundwater system. From the perspective of groundwater sustainability, recharge water is eventually recoverable through pumping or discharge to streams and groundwater dependent ecosystems. However, some non-consumptive water use is non-recoverable for direct beneficial use within the system. Water that flows to the ocean or to saline sinks is no longer directly suitable for most beneficial purposes, and is generally considered non-recoverable.

Irrigation efficiency: promises and pitfalls

The concept and interpretation of irrigation efficiency depends on the spatial scale and view of what constitutes beneficial use. In common use, irrigation efficiency generally focuses on field-scale water use, relating the amount of water that is consumptively used to the amount of water that is applied through irrigation. This localized, field-scale viewpoint does not adequately account for the many other beneficial uses of water within the larger hydrologic system, or the important role of non-consumptive use at the subbasin scale. Although crops do not consume all water that is applied through irrigation, much of the remaining balance of water is still beneficially used in the larger, subbasin-scale system, as it is recycled back to the groundwater system and downstream waterways. Additional considerations on the promises, pitfalls, and paradoxes of irrigation efficiency in water management planning are described by Lankford et al. (2020).

Non-consumptive water uses, especially for groundwater recharge, are important components of sustainable groundwater management. The next section describes the unexpected problems and drawbacks that arise when seeking higher irrigation efficiency as a means to support groundwater sustainability. This is especially the case if groundwater sustainability requires a decrease in consumptively used water, which is often more strongly correlated with the area of land being irrigated, and not the irrigation efficiency at the field scale.

Jevon's paradox

"Jevons' Paradox" describes a technology or policy that enhances the efficiency of using a natural resource, but does not necessarily lead to less consumption of that resource. A discussion of Jevon's Paradox in relation to irrigation efficiency is described by Sears et al. (2018).

Technologies and policies that support adoption of higher-efficiency irrigation systems are well-intentioned, but there may be unintended consequences that impede water conservation and sustainable groundwater management. Some of these consequences directly result from irrigation efficiency improvements: applying less water to an area and reducing the gap between irrigation and consumptive use also reduces deep percolation and seepage to the groundwater system. Other consequences may stem from behavioral responses and changes in irrigation resulting from these technologies and policies. If less water can be used to produce the same amount of a crop product, growers may be inclined to use the same amount of water and produce more. In other words, often the perception is that the water "saved" from higher irrigation efficiencies can now be used to irrigate additional land. This, compounded with the reduction in non-recoverable losses that recharge the groundwater system or support surface water bodies, can exacerbate groundwater sustainability concerns.

Improved irrigation efficiency can make matters worse

Grower education is an important step towards enabling growers to recognize the broader impact that irrigation efficiency improvements have on groundwater sustainability.

Improvements to water use efficiency have different meanings and consequences at the different scales of irrigation efficiency described by the FAO (Brouwer et al., 1989). Improving irrigation efficiency at the field-scale means that irrigation more closely matches consumptive use, and that less non-consumptive use occurs. These improvements can occur through changes in grower practices, and changes in irrigation methods, from "lower efficiency" surface irrigation that floods large areas of fields (e.g. at 60 percent efficiency) to "higher efficiency" pressurized irrigation that precisely applies water directly to plants (e.g. at 90-95 percent efficiency).

At the scale of the irrigation scheme, efficiency broadens to consider conveyance efficiency and the non-consumptive water uses that occur during irrigation water distribution. At this scale, efficiencies of 60-70 percent may be considered "higher efficiency," while the remaining 30-40 percent of water is "lost" to the groundwater system through seepage or to the atmosphere through evaporation.

At the subbasin-scale, significant interconnections exist between on-farm water management practices and groundwater sustainability. Losses to the groundwater system that, at the field-scale, were considered to decrease efficiency are instead considered internal to the subbasin hydrologic system, and valuable components of the sustainability equation. Improving field-scale irrigation efficiency can thus reduce the amount of water that recharges the aquifer, and potentially hinder sustainability.

Misunderstanding these interconnections can lead to the assumption that increasing field-scale irrigation efficiency will reduce water use and retain this water for other beneficial uses, enhancing sustainability. However, in practice "producers may willingly adopt more efficient systems, but may use the same amount of water either for a higher-water-use crop or put more acres into production" (ASCE, 2016), consuming more water in the end and pushing the basin farther from sustainability.

Grower education programs are valuable tools to demystify these interconnections, and to promote on-the-ground water management decisions that consider the benefits of both the consumed and non-consumed components of irrigation water. Understanding the distinction between beneficial and non-beneficial use can also help guide sustainable management decisions towards the highest return on investment with the lowest negative impacts. Additional information can be found in ASCE Manual 70 (ASCE, 2016) and Perry (2007).

Water quality and energy benefits

Beyond the interconnections to groundwater sustainability from a supply perspective, irrigation efficiency and on-farm water management decisions also have implications related to water quality and energy use. Improving irrigation efficiency can have a positive impact on water quality and energy use, as can water management decisions related to surface water and groundwater use.

Improving irrigation efficiency reduces the amount of water needed to irrigate a field and generally reduces runoff of nutrients and sediments, benefitting water quality in downstream waterways. Also, surface water available for irrigation in the Subbasin generally has lower salinity and lower total dissolved solids (TDS) than groundwater. Utilizing surface water for irrigation can benefit crop production and help to reduce soil salinity buildup or the need for additional water supply for leaching. Utilizing surface irrigation methods that contribute more surface water recharge to the groundwater system also has the potential to benefit local groundwater quality in areas where high nutrient loading is not a concern.

Improving irrigation efficiency reduces the amount of water needed to irrigate a field, and as a result reduces the energy needed to supply irrigation water to that field. Choices related to water supply use can also affect the total energy use needed in irrigating a field. Groundwater pumping is energy-intensive. By using surface water through gravity-fed irrigation systems, energy demands can be minimized and, in areas where surface water is offered to growers at low cost, the cost of water can also be reduced.

Further discussion on these other implications are described in Gleick et al. (2011).

References

American Society of Civil Engineers (ASCE). 2016. Evaporation, Evapotranspiration and Irrigation Water Requirements. Manual 70. Second Edition. M. E. Jensen and R. G. Allen (eds). Am. Soc. Civ. Engrs., 744 pp.

Barlow, P.M., Leake, S.A. and Fienen, M.N., 2018. Capture versus capture zones: Clarifying terminology related to sources of water to wells. *Groundwater*, 56(5), pp.694-704. Available from: <https://ngwa.onlinelibrary.wiley.com/doi/full/10.1111/gwat.12661>.

Bredehoeft, J.D., Papadopulos, S.S. and Cooper, H.H., 1982. Groundwater: The water budget myth. Scientific basis of water resource management, 51, p.57. Available from: https://www.eqb.state.mn.us/sites/default/files/documents/The_Water-budget_Myth.pdf

Lankford, B., Closas, A., Dalton, J., Gunn, E.L., Hess, T., Knox, J.W., van der Kooij, S., Lautze, J., Molden, D., Orr, S. and Pittock, J., 2020. A scale-based framework to understand the promises, pitfalls and paradoxes of irrigation efficiency to meet major water challenges. *Global Environmental Change*, 65, p.102182. Available from: <https://www.sciencedirect.com/science/article/pii/S0959378020307652>.

Leake, S.A., 2011. Capture—Rates and directions of groundwater flow don't matter!. *Groundwater*, 49(4), pp.456-458. Available from: <https://ngwa.onlinelibrary.wiley.com/doi/full/10.1111/j.1745-6584.2010.00797.x>

Sanden, B.L., Prichard, T.L., and Fulton, A.E., 2016. Assessing And Improving Water Penetration. In L. Ferguson and D.R. Haviland (Eds.), *Pistachio Production Manual*, Publication 3545. University of California Agriculture and Natural Resources (UCANR) Publications.

Sears, L., Caparelli, J., Lee, C., Pan, D., Strandberg, G., Vuu, L. and Lin Lawell, C.Y.C., 2018. Jevons' paradox and efficient irrigation technology. *Sustainability*, 10(5), p.1590. Available from: <https://www.mdpi.com/2071-1050/10/5/1590/htm>.

Theis, C.V., 1940. The source of water derived from wells. *Civil Engineering*, 10(5), pp.277-280. Available from: https://www.eqb.state.mn.us/sites/default/files/documents/Source_of_Water_Derived_from_Wells.pdf.

This page intentionally left blank.

Appendix 7-F
Central Valley Joint Venture 2020 Implementation Plan

This page intentionally left blank.



JOINT VENTURE
CONSERVING BIRD HABITAT

2020 IMPLEMENTATION PLAN



2020 IMPLEMENTATION PLAN

When referring to this document, please use the following citation:

Central Valley Joint Venture. 2020. Central Valley Joint Venture 2020 Implementation Plan. Sacramento, CA: U.S. Fish and Wildlife Service. Available from: www.centralvalleyjointventure.org

Cover photo: Waterfowl in the Sacramento Valley – Mike Peters

Central Valley Joint Venture 2020 Implementation Plan



EXECUTIVE SUMMARY





4

The Central Valley Joint Venture 2020 Implementation Plan uses the best available science to establish habitat and population objectives for the major groups of birds in the Central Valley of California. The Plan is intended to be useful to policy makers, regulators, agencies, conservation organizations and landowners working to further bird habitat conservation efforts in the Central Valley. The Plan represents the combined expertise of a wide range of professionals from conservation organizations, state and federal agencies and the private sector.

This 2020 Plan updates and expands the Central Valley Joint Venture (CVJV) 2006 Implementation Plan to incorporate new science, new bird groups and the practical constraints of water availability, conservation opportunities, current and predicted shifts in climate and the impacts and needs of human communities in the region.

The CVJV is a self-directed coalition consisting of 19 public and private organizations. For more than 30 years, the partnership has directed its efforts toward the common goal of meeting the habitat needs of migrating and resident birds in California's Central Valley. This Implementation Plan identifies specific goals and objectives for bird conservation that will drive the CVJV's efforts until the next plan update.

Protecting, restoring and managing habitat to benefit bird species also provides many benefits for other native Central Valley animals and plants. These species and habitats, in turn, collectively benefit the people and communities of this region through improved water quality, more effective flood control, increased recreational opportunities and improved quality of life from connection to natural spaces, among other benefits.

(1) San Luis National Wildlife Refuge, Kesterson Unit - Daniel Nylen/American Rivers (2) California black rail - Philip Robertson (3) American avocet in the non-breeding season - Tom Grey (4) American kestrel - Tom Grey

CENTRAL VALLEY BIRDS AND HABITAT

The Central Valley provides some of the most important bird habitat in North America. The Valley hosts one of the largest concentrations of migratory birds in the world during the fall and winter, in their non-breeding seasons, and also provides critical breeding habitat for a wide variety of bird species. Altogether, approximately 400 species of birds use the Central Valley during all or part of their lifecycles.

Once a vast mosaic of wetlands, riparian forests, grasslands, oak woodlands and saltbush scrub, the Central Valley has transformed dramatically over the last century. The loss of a large proportion of native habitat by conversion to agriculture, river channelization and urban development caused dramatic declines in wildlife. Many once-abundant bird species are now reduced to relatively small populations or are entirely gone from the region.

Despite this significant alteration of the Valley's natural landscape, land managers, landowners, conservation organizations and others work together to maintain valuable habitat and create new habitat in support of migratory bird populations. Since the 2006 plan, the CVJV and its partners have made clear and measurable improvements to critical bird habitat in the region.

CONSERVATION OBJECTIVES AND STRATEGIES

The Plan establishes short-term habitat and population objectives to guide conservation efforts over the next ten years. It also sets long-term (100-year) objectives that represent the ultimate conditions necessary to sustain bird populations.

In this Plan, the CVJV establishes conservation objectives for the following bird groups:

- non-breeding waterfowl
- breeding waterfowl
- non-breeding shorebirds
- breeding shorebirds
- breeding and non-breeding waterbirds
- breeding riparian landbirds
- breeding grassland-oak savannah landbirds
- at-risk bird species

The objectives cover habitat protection, enhancement and/or restoration; population levels; and in some cases, breeding density. Experts on each bird group used existing data from the Central Valley region, employed established methods and developed new methods when necessary to develop the objectives. Most of the chapters focusing on specific bird groups were developed from peer-reviewed scientific publications that are publicly available for readers seeking more in-depth information. The Plan also presents a framework for setting conservation objectives for all Central Valley bird species that are at particularly high risk of population decline (“at-risk bird species”).

The habitat objectives developed for each bird group, shown in Table ES. 1, are generally organized by the CVJV's five planning regions, collectively the CVJV's Primary Focus Area. The higher-elevation region surrounding the planning regions is the CVJV's Secondary Focus Area; this area is covered by the grassland bird habitat objectives.

Strategies to achieve the conservation objectives fall within four focal categories: land management and conservation, water management, funding and budgets and the human dimensions of conservation. Given the necessity of planning for uncertainty, the Plan includes an examination of the most likely scenarios under which priority conservation actions should take place. The two key drivers of these scenarios are conservation opportunities and water availability.

OTHER IMPORTANT CONSIDERATIONS

- **Water supplies:** Adequate water supplies are critical for wetland-dependent bird habitat, which includes both managed wetlands (such as refuges) and flooded agricultural lands.
- **Policy:** Public policy decisions play a significant role in bird conservation efforts.
- **Multiple benefits:** Bird conservation actions that also provide direct benefits to human communities, such as groundwater recharge, improved water quality and enhanced access to recreation, build increased support for the CVJV's efforts.
- **Climate considerations:** Major shifts in climate patterns in the Central Valley, occurring now and projected to occur over the next century, will have profound effects on bird populations.
- **Role of human communities:** It is critical to explicitly integrate human interests and motivations into conservation policies and programs.



The CVJV plays a critical role in the conservation of bird populations that depend on Central Valley habitats for some or all of their life cycles. Now, more than ever before, a collaborative approach to bird conservation is critical; no single organization could successfully address this complex issue alone. Working through voluntary partnerships and guided by its science-based Implementation Plan, the CVJV is well-equipped to lead this effort.

Pintails using a postharvest-flooded rice field during their non-breeding season – Mike Peters

HABITAT TYPE	PLANNING REGION					VALLEY-WIDE
	SACRAMENTO	YOLO-DELTA	SUISUN	SAN JOAQUIN	TULARE	
Managed Semi-Permanent Wetlands	9,420	7,160	1,355	9,378	7,055	34,368
Managed Seasonal Wetlands	6,875	4,500		5,837	2,792	20,004
Managed Seasonal Wetland Enhancement	6,256	2,196	2,386	5,330	1,795	17,963 annually
Riparian Habitat	8,377	5,906	1,408	8,368	9,273	33,332
Winter-Flooded Rice	324,847	15,823				340,670 annually
Agricultural Easements	54,000					54,000
Grassland (Secondary Focus Area)						10,337
Oak Savannah (throughout Primary Focus Area)						8,483

TABLE ES. 1 Habitat conservation objectives (acres), integrated across all bird groups, by planning region and for the Central Valley as a whole. (See the Conservation Delivery chapter for more details.)

ACKNOWLEDGMENTS

On behalf of the Central Valley Joint Venture Management Board, we extend our appreciation to the many organizations, agencies, agricultural and water communities and private individuals who generously contributed their time and expertise to the process of developing this Implementation Plan. Special thanks go to the Plan's chapter authors, CVJV committee members, Plan reviewers and the editorial and design team. Without your knowledge and input, this document would not have been possible. Because of your contributions, this document is well positioned to guide bird conservation efforts in the Central Valley over the next decade.

Mike Dunphy
CVJV Coordinator 2014-2018

Ruth Ostroff
Acting CVJV Coordinator 2019

A Special Thank You To:

Former Central Valley Joint Venture Coordinators Gary Kramer, Dave Paullin and Bob Shaffer, for developing the 1990 and 2006 Implementation Plans and ensuring a successful and enduring partnership.

Mary C. Derr and Nina Erlich-Williams of Public Good PR, and Jane Brady and Chris Seager of Emergency Design, for their countless hours editing and designing the Plan.

All of the photographers who allowed the use of their beautiful photographs throughout the Plan.

Implementation Plan Update Committee members: Brad Burkholder, Tom Gardali, Catherine Hickey, Dean Kwasny, Jeff McCreary, Khara Strum, Rachel Zwillinger and Greg Yarris.

Technical Task Force members: Tom Gardali (Chair), Jeanne Brantigan, Brad Burkholder, Mike Dunphy, Virginia Getz, Catherine Hickey, Mark Petrie and Greg Yarris.

For Outstanding Work On Plan Chapters: (lead author listed first)

Conservation Delivery: Mark Petrie and Jeff McCreary

Environmental, Social and Political Landscape:

Background: Virginia Getz, Ruth Ostroff and members of the CVJV Lands Committee

Water: Jeanne Brantigan and members of the CVJV Water Committee

Policy: Mark Hennelly, Jeff Volberg and members of the CVJV Legislative Affairs Committee

Climate: Claudia Mengelt, Jim Weigand and Tom Gardali

Multiple Benefits: Nathaniel Seavy

Human Dimensions of Bird Conservation: Ashley Dayer and Ron Meyers

Non-Breeding Waterfowl: Mark Petrie

Breeding Waterfowl: Greg Yarris, Josh Ackerman, Caroline Brady, Mike Casazza, Cliff Feldheim, Mark Herzog, Elliott Matchett, Brian Olson and Dan Skalos

Non-Breeding Shorebirds: Kristen Dybala, Catherine Hickey, Matthew Reiter, Dave Shuford, Khara Strum and Greg Yarris

Breeding Shorebirds: Khara Strum, Kristen Dybala, Monica Iglecia and Dave Shuford

Breeding and Non-Breeding Waterbirds: Dave Shuford and Kristen Dybala

Breeding Riparian Landbirds: Kristen Dybala, Neil Clipperton, Thomas Gardali, Greg Golet, Rodd Kelsey, Stefan Lorenzato, Ron Melcer, Nathaniel Seavy, Joe Silveira and Greg Yarris

Breeding Grassland-Oak Savannah Landbirds: Ryan DiGaudio, Kristen Dybala, Nathaniel Seavy and Thomas Gardali

At-Risk Bird Species: Dave Shuford and Meghan Hertel

Maps and figures: Kristen Dybala, Dan Fehringer, Elliott Matchett, Kat Powelson and Greg Yarris

Plan Contributors: (in alphabetical order, * indicates Board member)

Organizations

Audubon California – Samantha Arthur, Meghan Hertel, Monica Iglecia, Mike Lynes and Khara Strum*

California Association of Resource Conservation Districts – Sara Schremmer*

California Rice Commission – Paul Buttner and Luke Mathews

California Waterfowl Association – Caroline Brady, Mark Hennelly, Jake Messerli* and Jeff Volberg

Defenders of Wildlife – Rachel Zwillinger*

Ducks Unlimited, Inc. – Mark Biddlecomb, Dan Fehringer, Virginia Getz, Gary Link, Jeff McCreary* and Mark Petrie

Northern California Water Association – Todd Manley

Point Blue Conservation Science – Ryan DiGaudio, Kristen Dybala, Thomas Gardali, Geoff Geupel, Catherine Hickey*, Gary Page, Matthew Reiter, Nathaniel Seavy, Dave Shuford and Julian Wood

River Partners – John Carlon, Julie Rentner and Helen Swagerty*

The Nature Conservancy – Jeanne Brantigan*, Greg Golet, Rodd Kelsey, Paul Spraycar and Jordan Wellwood

Tulare Basin Watershed Partnership (previously Tulare Basin Wildlife Partners) – Carole Combs, Rob Hansen, Dick Moss and Larry Saslaw

State Agencies

California Department of Fish and Wildlife – Andy Atkinson, Brad Burkholder*, Neil Clipperton, Bill Cook, Brian Olson, Jeffrey Shu, Dan Skalos, Erin Tennant and Dan Yparraguirre

California Department of Water Resources – Cliff Feldheim*, Stefan Lorenzato and Ron Melcer

California Natural Resources Agency – Chris Potter*

California Wildlife Conservation Board – James Croft, John Donnelly*, Scott McFarlin and Peter Perrine

Federal Agencies

U.S. Army Corps of Engineers – Mariah Brumbaugh, Patty Goodman* and Mario Parker

U.S. Bureau of Land Management – Harry McQuillen, Brian Novosak* and Jim Weigand

U.S. Bureau of Reclamation – Heather Casillas* and Dan Strait

U.S. Fish and Wildlife Service – Jennifer Brown, Lily Douglas, Mike Dunphy, Rachel Dutch, Kim Forrest, Dale Garrison*, Matt Hamman, Craig Isola, Claudia Mengelt, Sandy Osborn, Ruth Ostroff, Mark Pelz, Kat Powelson, Patricia Roberson, Joe Silveira, Karleen Volherbst and Greg Yarris

U.S. Geological Survey – Josh Ackerman, Mike Casazza, Mark Herzog, Tom Kimball* and Elliott Matchett

U.S.D.A. Natural Resources Conservation Service – Alan Forkey, Dean Kwasny* and Tom Moore

Other Contributors

Altshuler Berzon LLP – Hal Candee

Grassland Water District – John Beam, Ric Ortega, Ken Swanson and Ellen Wehr Trescott

Marty Ecological Consulting – Jaymee Marty

Pacific Gas and Electric Company – Mike Best*

Private Consultants – Ashley Dayer and Ron Meyers

Suisun Resource Conservation District – Steve Chappell, John Takekawa and Bruce Wickland

University of California, Davis – John Eadie

MISSION AND PARTNERS



Partnering to conserve Central Valley birds and their habitats for current and future generations.





Loafing ducks, perched peregrine falcon, Sacramento NWR - Mike Wolder

ACRONYMS

TERM	DEFINITION
ACEP	Agricultural Conservation Easement Program
AHM	Adaptive harvest management
AJVMB	Association of Joint Venture Management Boards
BBC	Breeding Bird Census
BCR	Bird Conservation Region
BLM	Bureau of Land Management, U.S. Department of the Interior
BMPs	Best management practices
CBPAR	Community-based participatory action research
CDFW	California Department of Fish and Wildlife
CPIF	California Partners in Flight
CRHCP	California Riparian Habitat Conservation Program
CVBC	Central Valley Bird Club
CVHJV	Central Valley Habitat Joint Venture
CVJV	Central Valley Joint Venture
CVLCP	Central Valley Landscape Conservation Project
CVP	Central Valley Project
CVPIA	Central Valley Project Improvement Act
CWA	California Waterfowl Association or Clean Water Act
DGP-GIC	Department of Geography and Planning and Geographical Information Center, California State University, Chico
DU	Ducks Unlimited
DWR	California Department of Water Resources
EJO	Environmental justice organization
ER	Ecological reserve
EREP	Environmental restoration and enhancement projects
ESA: CESA	California Endangered Species Act
ESA: FESA	Federal Endangered Species Act of 1973, as amended (16 U.S.C. 1531 et seq.)
GEA	Grasslands Ecological Area
GIC	Geographical Information Center. See also DGP-GIC.
GIS	Geographic Information System
GRCD	Grassland Resource Conservation District
GSAs	Groundwater Sustainability Agencies
GSPs	Groundwater Sustainability Plans
GWD	Grassland Water District
ICP	Interagency Coordinated Program
ILRP	Irrigated Lands Regulatory Program
IPCC	Intergovernmental Panel on Climate Change

TERM	DEFINITION
IRWMT	Interagency Refuge Water Management Team
IWCP	Inland Wetlands Conservation Program
JV	Joint Venture
LIP	Landowner Incentive Program
LTA	Long-term average
L4	Refuge water supplies, Full Level 4
NABCI	North American Bird Conservation Initiative
NAWCA	North American Wetlands Conservation Act
NAWMP	North American Waterfowl Management Plan
NGO	Non-governmental organization
NRCS	Natural Resources Conservation Service, U.S. Department of Agriculture
NWR	National Wildlife Refuge
PRBO	Point Reyes Bird Observatory
RCD	Resource Conservation District
RCPP	Regional Conservation Partnership Program
RD	Reclamation District
RWSP	Refuge Water Supply Program
SGMA	Sustainable Groundwater Management Act of 2014
SHARE	Shared Habitat Alliance for Recreational Enhancement Program
SHC	Strategic Habitat Conservation (the term the U.S. Fish and Wildlife Service uses for landscape-scale conservation of habitats)
SMART	Specific, measurable, achievable, relevant, and time-bound (as applied to goal-setting)
SSC	Species of special concern (a designation by the California Department of Fish and Wildlife)
SWP	State Water Project
SWRCB	State Water Resources Control Board
TC	Technical committee
USBR	U.S. Bureau of Reclamation (also called "Reclamation"), U.S. Department of the Interior
USDA	U.S. Department of Agriculture
USFWS	U.S. Fish and Wildlife Service, U.S. Department of the Interior
USGS	U.S. Geological Survey, U.S. Department of the Interior
WA	Wildlife Area
WCB	Wildlife Conservation Board
WHEP	Waterbird Habitat Enhancement Program
WMA	Wildlife Management Area (a unit of the National Wildlife Refuge System)
WRE	Wetland Reserve Easement

CONTENTS

Executive Summary	i
Acknowledgments	v
Central Valley Joint Venture Mission	vii
Central Valley Joint Venture Partners	vii
Acronyms	ix

SECTION I: THE BIG PICTURE

CHAPTER 1: Introduction to the 2020 CVJV Implementation Plan	3
The Central Valley Joint Venture	3
The Implementation Plan	5
New Approaches	6
Literature Cited	6
CHAPTER 2: Planning for Conservation Success	7
Framework	7
Delivery of Conservation Actions	9
Bird Habitat Conservation Successes	9
Evaluating Conservation Success	10
Literature Cited	10
CHAPTER 3: Conservation Delivery	11
Introduction	11
Integrated Bird Habitat Objectives	13
Habitat Objectives by Bird Group	15
Scenario Planning	19
Identifying Priority Conservation Actions for Each Future Scenario	21
Operationalizing Scenario Planning	23
Literature Cited	23

SECTION II: SETTING THE STAGE

CHAPTER 4: Environmental, Social and Political Landscape	27
CHAPTER 4.1: Background	27
CVJV Geographic Area	27
Planning Regions and Basins	29
Primary Focus Area Overview	29
Primary Focus Area Basin Descriptions	30
Secondary Focus Area	40
CHAPTER 4.2: Water	41
History of Central Valley Wetland Water Supplies	42
Central Valley Wetland Water Supplies Today	47
Wetland Water Supply Challenges	54
Wetland Water Opportunities	57

CHAPTER 4.3: Policy	61
Programs and Regulatory Actions That Affect CVJV Habitat Goals and Objectives	63
Success Story: Wetland Habitat Restoration on Faith Ranch	66
CHAPTER 4.4: Climate	67
Shifting Climate Conditions	68
Effects of a Shifting Climate on Central Valley Bird Populations	71
CHAPTER 4.5: Multiple-Benefit Projects	73
Hamilton City: A Blueprint for Multiple-Benefit Projects in California	75
Literature Cited	77
CHAPTER 5: Human Dimensions of Bird Conservation	82
Priority Human Dimensions Topics in the Central Valley	83
Hunters	84
Farmers	85
Non-Hunting Recreationists	86
Urban Residents	87
Ecosystem Services	88
Environmental Justice	89
Multiple Benefits	90
Literature Cited	91

SECTION III: CONSERVATION OBJECTIVES BY BIRD GROUP

CHAPTER 6: Introduction to Bird Conservation Objectives	95
The Conservation Objectives	95
Literature Cited	97
CHAPTER 7: Non-Breeding Waterfowl	98
Chapter Summary	99
Introduction	100
Conservation Goal	100
Biological Planning	101
Conservation Design	106
Conservation Delivery	121
Literature Cited	122
CHAPTER 8: Breeding Waterfowl	124
Chapter Summary	125
Introduction	126
Conservation Goal	127
Biological Planning	128
Conservation Design	137

Conservation Delivery	143	CHAPTER 12: Breeding Riparian Landbirds	190
Summary	144	Chapter Summary	191
Success Story: The California Waterfowl Habitat Program	145	Introduction	192
Literature Cited	147	Conservation Goal	192
CHAPTER 9: Non-Breeding Shorebirds	150	Which Species Are Included?	193
Chapter Summary	151	Which Geographic Areas Are Included?	194
Introduction	152	Current Conditions	195
Conservation Goal	152	Developing the Conservation Objectives	196
Which Species Are Included?	153	Conservation Objectives	197
Which Geographic Areas Are Included?	154	Applying the Conservation Objectives	198
Current Conditions	155	Success Story: Least Bell's Vireo Reappears in the Central Valley	199
Developing the Conservation Objectives	156	Additional Conservation Considerations	200
Conservation Objectives	157	Literature Cited	201
Applying the Conservation Objectives	159	CHAPTER 13: Breeding Grassland – Oak Savannah Landbirds	202
Additional Conservation Considerations	160	Chapter Summary	203
Success Story: BirdReturns Habitat Program	161	Introduction	204
Literature Cited	163	Conservation Goal	204
CHAPTER 10: Breeding Shorebirds	164	Which Species Are Included?	205
Chapter Summary	165	Which Geographic Areas Are Included?	206
Introduction	166	Current Conditions	207
Conservation Goal	166	Developing the Conservation Objectives	208
Which Species Are Included?	167	Conservation Objectives	209
Which Geographic Areas Are Included?	168	Applying the Conservation Objectives	210
Current Conditions	169	Success Story: Local Land Trusts in the Sierra Nevada Foothills	211
Developing the Conservation Objectives	170	Additional Conservation Considerations	212
Conservation Objectives	171	Literature Cited	213
Applying the Conservation Objectives	172	CHAPTER 14: At-Risk Bird Species	214
Additional Conservation Considerations	173	Chapter Summary	215
Success Story: Tulare Basin Wetlands	174	Introduction	216
Literature Cited	175	Conservation Goal	216
CHAPTER 11: Breeding and Non-Breeding Waterbirds	176	Which Species Are Included?	217
Chapter Summary	177	Which Geographic Areas Are Included?	219
Introduction	178	Developing the At-Risk Species List	220
Conservation Goal	178	Current Conditions	221
Which Species Are Included?	179	Conservation Objectives	223
Which Geographic Areas Are Included?	180	Conservation Considerations for At-Risk Species	224
Current Conditions	181	Success Story: Tricolored Blackbird Working Group	225
Developing the Conservation Objectives	182	Literature Cited	227
Conservation Objectives	183	Glossary	229
Applying the Conservation Objectives	185	List of Figures	237
Success Story: Sandhill Crane Festival	186	List of Tables	240
Additional Conservation Considerations	187		
Literature Cited	189		

SECTION I



THE BIG PICTURE



- 1 Introduction to the 2020 CVJV Implementation Plan** pXX
- 2 Planning for Conservation Success** pXX
- 3 Conservation Delivery** pXX



THE CENTRAL VALLEY JOINT VENTURE

The CVJV is one of 21 habitat-based Migratory Bird Joint Ventures in North America, all of which work to protect and restore bird habitat. The U.S. Fish and Wildlife Service (USFWS) provides guidance for the establishment and organization of Joint Ventures. The USFWS defines Joint Ventures as self-directed partnerships of agencies, organizations, corporations, tribes and individuals that have formally accepted the responsibility of implementing national or international bird conservation plans within a specific geographic area or for a specific taxonomic group and have received general acceptance in the bird conservation community for such responsibility (USFWS 2005).

The Joint Ventures were established after the adoption of the 1986 North American Waterfowl Management Plan (NAWMP), an international plan focused on strategies to recover waterfowl populations. The NAWMP identified the CVJV, originally called the Central Valley Habitat Joint Venture, as one of the original six priority areas on the continent to focus on waterfowl conservation. It was renamed the Central Valley Joint Venture in 2004.

The CVJV is currently administered through a coordination office within the USFWS and is guided by a management board that receives input and recommendations from four standing committees and a variety of working groups and ad hoc committees. Its management board is composed of representatives from 19 partner organizations, including non-governmental organizations, state and federal agencies, and one regulated utility. The board members work cooperatively to address the habitat needs of migratory and resident bird species in California's Central Valley. Originally focused exclusively on waterfowl, the CVJV's mission has expanded over time to also encompass the conservation needs of shorebirds, waterbirds, landbirds, and at-risk bird species.

Many bird populations and habitats throughout North America have continued to suffer steep declines (NABCI 2016) over the past ten years. The Central Valley Joint Venture (CVJV) plays a critical role in the conservation of bird populations that depend on Central Valley habitats for some or all of their life cycles. Now, more than ever before, a collaborative approach to bird conservation is critical; no single organization could successfully address this complex issue alone. The CVJV, working through voluntary, non-regulatory partnerships and guided by its science-based Implementation Plan, is well-equipped to play a leadership role in this effort. Taken together, the previous two CVJV Implementation Plans tell the story of how CVJV bird conservation efforts have expanded over time. This Implementation Plan builds on and expands upon that earlier work.

(1) Butte Sink Wildlife Management Area - Mike Peters (2) Least bittern - Tom Grey (3) Sandhill cranes at Cosumnes River Preserve, Sacramento County - BLM

**The Central Valley
Joint Venture works
collaboratively through
diverse partnerships
to protect, restore, and
enhance wetlands and
associated bird habitats
in accordance with
conservation strategies
identified in the CVJV's
Implementation Plan.**



THE IMPLEMENTATION PLAN

In 1990, the CVJV published the Central Valley Habitat Joint Venture Implementation Plan (CVHJV 1990), its first strategic plan, to help guide delivery of partnership-based conservation of waterfowl habitat. The 1990 Plan was updated in 2006 and retained a waterfowl focus while incorporating new information and objectives for shorebirds, waterbirds and riparian songbirds.

The 2020 Central Valley Joint Venture Implementation Plan builds on the previous plans and is organized into three sections:

- I. The Big Picture provides an introduction to the CVJV partnership, describes the conservation planning approach, presents the overarching conservation objectives for the CVJV geographic area and identifies conservation delivery strategies.
- II. Setting the Stage provides an overview of the geographic area covered by the Plan and the social and political landscape within which the CVJV operates, and examines the human dimensions of wildlife conservation.
- III. Conservation Objectives by Bird Group identifies biologically-based conservation objectives for the eight bird groups on which the CVJV focuses its efforts.



Gray Lodge Wildlife Area - Brian Gilmore

NEW APPROACHES

Several new approaches guided the development of this Plan.

- 1. Role of human communities:** The Plan describes and identifies priority topics related to the human dimensions of bird conservation. This is the CVJV's first effort to explicitly integrate human interests and motivations into policies and programs.
- 2. Conservation delivery:** The Plan identifies potential future scenarios that allow for adaptability in identifying and implementing priority conservation strategies and actions.
- 3. Multiple benefits:** The Plan promotes land use projects designed to meet societal needs, enhance ecological function and improve habitat quality for fish and wildlife that also provide additional benefits such as groundwater recharge, improved water quality and enhanced access to recreation. Bird conservation actions that incorporate these types of benefits encourage increased support for achieving CVJV objectives.
- 4. Climate considerations:** The Plan considers major shifts in climate patterns projected to occur over the next century in the Central Valley and summarizes the vulnerability of the region's bird populations to a shifting climate.
- 5. Planning regions:** A number of the chapters in Section III use planning regions rather than basins as the core unit for management actions. Some of the planning regions incorporate multiple basins to reflect the current scientific knowledge and conservation needs of the different bird communities.
- 6. Expanded focus:** The 2020 Plan incorporates additional habitat types and bird communities not considered in previous Implementation Plans (i.e., at-risk bird species and grassland and oak savannah birds and their habitats).
- 7. Technical documentation:** Chapters focusing on specific bird groups were developed from peer-reviewed publications (UC Davis 2017). These papers are publicly available for readers seeking more in-depth information.

Through the strong partnerships fostered by the CVJV, diverse interests are brought together to create what would otherwise be unlikely conservation outcomes. Despite the significant alteration of California's landscape in modern times, wildlife managers, landowners, conservation organizations, and others have achieved considerable conservation successes. As in previous versions, the current Plan provides habitat and population objectives for the next ten years. The Plan is intended to be useful to policy makers, regulators, conservation organizations, and landowners in furthering bird habitat conservation efforts in the Central Valley.

LITERATURE CITED

- [CVHJV] Central Valley Habitat Joint Venture. 1990. Central Valley Habitat Joint Venture implementation plan — a component of the North American Waterfowl Management Plan. Sacramento, CA: U.S. Fish and Wildlife Service. Available from: http://www.centralvalleyjointventure.org/assets/pdf/cvju_implementation_plan.pdf
- [NABCI] North American Bird Conservation Initiative. 2016. The State of North America's Birds 2016. Environment and Climate Change Canada: Ottawa, Ontario. 8 p. Available from: <http://www.stateofthebirds.org/2016/>
- UC Davis. 2017. Central Valley Joint Venture special issue. San Franc Estuary Watershed Sci. 15(1). Available from: https://escholarship.org/uc/jmie_sfews/15/1
- [USFWS] U.S. Fish and Wildlife Service. 2005. Joint ventures. In: U.S. Fish and Wildlife Service, Service Manual Chapters. Available from: <https://www.fws.gov/policy/721fw6.html>



Privately-owned wetland, San Joaquin Basin - Ryan DiGaudio

The Central Valley Joint Venture uses a variety of methods to ensure success in its bird conservation work. This chapter looks at the three methods the CVJV uses to guide conservation planning: Strategic Habitat Conservation, scenario planning, and Joint Venture planning at the national level. It highlights successful delivery of conservation actions since the adoption of CVJV's first Implementation Plan in 1990, the Central Valley Habitat Joint Venture Implementation Plan (CVHJV 1990).

Finally, the chapter shares research and monitoring activities undertaken by CVJV partners to evaluate and improve conservation planning.

FRAMEWORK

Strategic Habitat Conservation

The CVJV has adopted a strategic, science-based philosophy toward bird habitat conservation and uses a framework called Strategic Habitat Conservation (SHC) to maximize benefits to bird populations while minimizing costs of conservation investments.

Strategic Habitat Conservation (Figure 2.1) is a specific form of adaptive resource management (Walters 1986; Walters and Holling 1990; Williams 2003) that uses an iterative process to evaluate the effectiveness of habitat management actions. It encompasses four broad elements: biological planning, conservation design, delivery of conservation actions, and monitoring and research. Strategic Habitat Conservation moves wildlife conservation beyond the opportunistic and into the strategic realm, using an adaptive framework to ensure that learning and enhancements to conservation strategy occur.

Scenario Planning

Natural resource managers today face unprecedented challenges arising from changes in factors such as land use, drought, climate patterns and invasive species. These challenges introduce numerous uncertainties that can complicate decision-making. Scenario planning is a structured way of developing a narrative about potential futures based on key uncertainties.

The 2006 Implementation Plan assumed that environmental conditions and conservation opportunities that had characterized the previous decade would continue, but that was not the case. In just ten years, wetland restoration opportunities declined due to such things as unanticipated high commodity and land prices and changes to regulatory requirements. Further, multiple years of severe drought resulted in curtailed water supplies to existing wetland and agricultural habitats. This shift in conditions illustrates the importance of identifying strategies that are robust across a variety of potential future conditions (Cook et al. 2014). Scenario planning is one tool that can be used to develop such strategies (Peterson et al. 2003).

The CVJV used scenario planning as a tool to develop this Implementation Plan, with the goal of identifying actions that would achieve the CVJV bird population and habitat objectives under a range of possible futures. The CVJV developed future scenarios by hosting four workshops that engaged a variety of CVJV partners. Each workshop encouraged team building and creative, solution-oriented thinking and followed a process of (1) identifying key drivers of the system (those critical elements that can contribute to conservation success or failure);

(2) exploring drivers with the greatest uncertainty over a 10-year time horizon; and (3) integrating the uncertainty in these drivers into narratives that define four scenarios of future conditions. The workshops included identifying conservation strategies to use in a particular scenario or in multiple scenarios. The Conservation Delivery chapter discusses the strategies that were identified as being robust under multiple scenarios.

The two key drivers of the system, identified during the scenario planning exercise, are water availability and conservation opportunity. Wetland water supplies are clearly a critical driver of the amount and quality of flooded habitat in the Central Valley. The workshop groups expressed the uncertainty in water supply over the next 10 years as a gradient from high water supply to low water supply.

The groups quantified this gradient from High to Low as:

- 1) Full Level 4 Central Valley Project Improvement Act (CVPIA) refuge water supplies, sufficient surface water supplies for existing and future restored wetlands, sufficient water supplies for rice producers wanting to winter-flood.
- 2) Recent water supplies in an average water year (i.e., typical water supplies).
- 3) 25% reduction in average water supplies.
- 4) 50% reduction in average water supplies.
- 5) 75% reduction in average water supplies.

In defining conservation opportunity, the workshop groups identified three main aspects:

1. The cost of purchasing land for conservation. Commodity prices, patterns of urban development, and other factors will all drive the cost of land. When land prices are low, there are more numerous traditional conservation opportunities than when land prices are high (e.g., there is little interest in converting rice fields to wetlands when commodity prices are high).
2. Public support and funding for conservation. When public policies support conservation, funding is readily available and there are more conservation opportunities than when support is low.
3. Hunter numbers. If hunter numbers go up, there will be more conservation opportunities. If hunter numbers decline, it could erode support for waterfowl conservation in general (e.g., annual public land expenditures that benefit waterfowl), and reduce current and future investments in waterfowl hunting clubs and leases.

Together, these variables describe a conservation opportunity axis that varies from high (available funds and low land prices) to low (little funding and high land prices).

These drivers are both important, and they span a continuum of environmental and social conditions with inherent uncertainty. To capture the uncertainty, the workshop groups defined four scenarios based on the continuum of identified drivers (Figure 2.2): Build Resilience (high water availability and high conservation opportunity), High and Dry (high conservation opportunity but low water availability), Catch Your Breath (high water availability but low conservation opportunity), and Crisis Management (low water availability and low conservation opportunity). The groups then created qualitative narratives that described the situations under each of these scenarios.

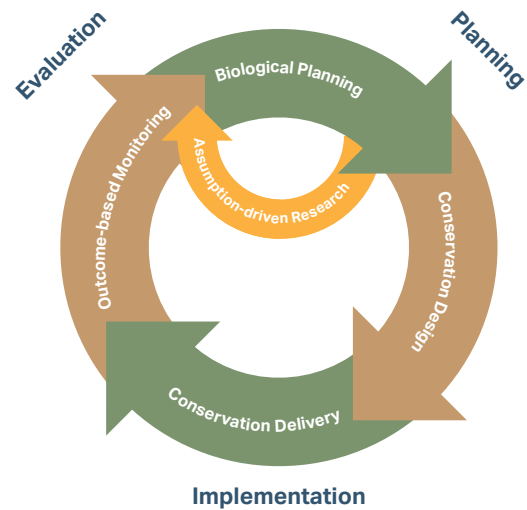

FIGURE 2.1 The elements of Strategic Habitat Conservation.

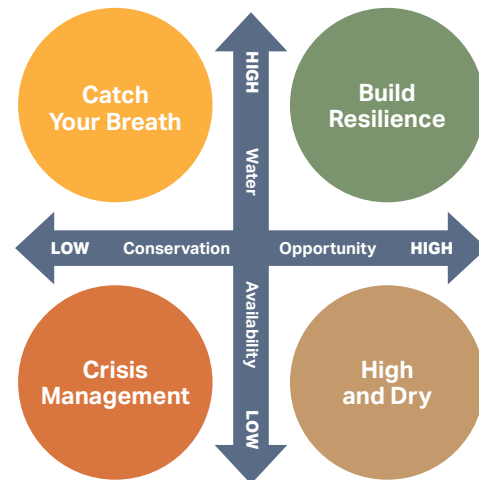

FIGURE 2.2 Conservation opportunity and water availability interact to drive scenario planning.

Joint Venture Planning at the National Level

At a national level, the Migratory Bird Joint Venture Program defines technical expectations for Joint Ventures in the broad categories of biological planning; conservation design; habitat delivery; monitoring; research; and communication, education and outreach. As one of the original Joint Ventures, the CVJV continues to be successful in meeting many of these expectations as they relate to the ability to deliver waterfowl conservation, and, to a slightly lesser degree, shorebird conservation. The CVJV is also making progress in the area of landbird conservation, including riparian birds and, more recently, grassland and oak savannah birds. However, there is considerable work to be done to enhance the CVJV's ability to coordinate, implement, and evaluate the progress of bird habitat conservation. This updated Implementation Plan addresses these deficiencies.

DELIVERY OF CONSERVATION ACTIONS

The CVJV's efforts to protect, restore, and enhance migratory bird habitats, first guided by the 1990 Central Valley Habitat Joint Venture Implementation Plan (CVHJV 1990) and later by the 2006 CVJV Implementation Plan, significantly increased migratory bird habitat in the Central Valley, benefitting a variety of birds and other wildlife. People also continue to benefit through improved water quality, more effective flood control, and increased recreational opportunities. Using a collaborative, voluntary approach and guided by this updated Plan, CVJV partners will work to ensure that the benefits of habitat conservation continue to expand for both wildlife and people.

The CVJV gauges conservation success by gains in habitat quality and quantity, accomplished through habitat protection, restoration, and enhancement projects aligned to achieve bird conservation objectives. Strong partnerships within the CVJV have generated considerable conservation successes by utilizing federal, state, and non-governmental conservation programs and funding.

Since the 2006 plan, the CVJV and its partners have delivered numerous bird habitat conservation achievements (see "Bird Habitat Conservation Successes" sidebar). These are just a few of the programs in the CVJV "toolbox" that have proven successful in achieving CVJV habitat objectives over the last decade. By broadening bird habitat conservation goals with this 2020 Plan, CVJV partners will make additional contributions toward the long-term goal of ensuring vital populations of birds into the future.

BIRD HABITAT CONSERVATION SUCCESSES

Since the 2006 Implementation Plan...

- Through the North American Wetlands Conservation Act grant program, from 2006 to 2018, CVJV partners leveraged almost \$50 million in grant funding with more than two and a half times this amount in other funding. This effort has resulted in protection of more than 26,000 acres of habitat, restoration of more than 42,000 acres, and enhancement of 250,000 acres.
- Working with private landowners, the USFWS Partners for Fish and Wildlife Program has provided \$4.8 million dollars in federal funds and leveraged an additional \$19 million in matching funds to restore and/or enhance 24,300 acres of wetlands, 7,000 acres of associated uplands, and 104 miles of stream/shoreline within the Central Valley.
- The Inland Wetlands Conservation Program of the California Wildlife Conservation Board was created in 1990 specifically to assist the CVJV in its mission. Using a wide range of options to accomplish wetland conservation, the program restored and enhanced more than 65,000 acres of wetland habitat in the Central Valley between 2006 and 2018.
- The USDA Natural Resources Conservation Service (NRCS) has protected and restored 32,825 acres of wetlands and associated uplands in California's Central Valley under the Wetland Reserve Program and has enrolled 20 percent of rice-growing acres in habitat-enhancing practices under the Waterbird Habitat Enhancement Program.

EVALUATING CONSERVATION SUCCESS

CVJV partners continue to make considerable investments in the priorities outlined in the CVJV Monitoring and Evaluation Plan (CVJV 2010), which refined the ecological and biological assumptions used for this Plan.

These investments are critical to strengthen the science-based foundations of CVJV planning. For example, our understanding of the abundance and distribution of wetlands in the Central Valley improved since 1990 as the accuracy and precision of remote sensing tools improved. The 1990 Plan estimated that there were roughly 300,000 acres of managed wetlands remaining at that time, but later satellite imagery showed that the number was closer to 150,000 acres. Thus, the CVJV modified habitat objectives in the 2006 Plan. Due to improved technology and to conservation successes, the CVJV estimate was further refined for this Plan to show that there are now more than 220,000 acres of managed wetlands in the Central Valley.

Examples of how CVJV investments in research have paid off since publication of the 2006 Plan include:

- CVJV partners can now quantify in “near-real time” the amount of open surface water on the landscape, and that information is publicly available to land managers and decision-makers.
- A non-breeding shorebird survey is up and running to assess changes in numbers and distribution. Already scientists are using this survey’s dataset to assess shorebird response to the most recent drought. Results from this study will also allow scientists to assess long-term trends in shorebird populations and habitat use.
- A riparian landbird survey on the Sacramento and San Joaquin Rivers and in the Delta provides baseline data that can assess long-term changes in populations. This survey helped inform the development of the latest riparian bird population objectives.
- All known waterbird colonies are catalogued. This baseline dataset will soon be archived online and available to the scientific community to assess changes in the future distribution of colonies, as well as for local or regional planning purposes such as the state’s high-speed rail project.
- Data from nearly 30,000 dabbling duck nest records in California were archived into a computer database for secure long-term storage and retrieval. This archive of historical nesting information allows scientists to study

long-term trends in habitat use and reproductive success, and it provides guidance to improve programs for locally nesting ducks.

- Comparative studies demonstrate a clear link between improved winter habitat conditions and increased waterfowl body condition and survival in the Central Valley. Results from these long-term studies support the original CVJV premise that restoring and enhancing habitat (including flooded agriculture) is an essential activity for restoring waterfowl populations.
- CVJV organizations are leading studies that identify where and when instream flows or reservoir releases can benefit both fish and birds.

The development and release of the Monitoring and Evaluation Plan followed the release of the 2006 Implementation Plan. In the spirit of innovation and adaptive management, the CVJV has now elected to develop a more comprehensive science and monitoring needs assessment. During the assessment, which will begin in 2020, the CVJV will develop methods to evaluate progress toward the biological objectives and to test whether the conservation strategies and actions yield the intended ecological and social outcomes. The iterative process of testing biological assumptions to improve conservation planning and delivery is germane to the Strategic Habitat Conservation process, and it bridges the gap between managers and researchers.

LITERATURE CITED

- [CVHJV] Central Valley Habitat Joint Venture. 1990. Central Valley Habitat Joint Venture Implementation Plan — a component of the North American Waterfowl Management Plan. Sacramento (CA): U.S. Fish and Wildlife Service. 102 p. Available from: http://www.centralvalleyjointventure.org/assets/pdf/cv_jv_implementation_plan.pdf
- [CVJV] Central Valley Joint Venture. 2010. Monitoring & Evaluation Plans. Available from: <https://www.centralvalleyjointventure.org/science/monitoring>
- Cook CN, Inayatullah S, Burgman MA, Sutherland WJ, Wintle BA. 2014. Strategic foresight: how planning for the unpredictable can improve environmental decision-making. *Trends Ecol Evol.* 29:531-541.
- Peterson GD, Cumming GS, Carpenter SR. 2003. Scenario planning: a tool for conservation in an uncertain world. *Conserv Biol.* 17:358-366.
- Walters CJ. 1986. Adaptive management of renewable resources. MacMillan, New York, New York, USA.
- Walters CJ, Holling CS. 1990. Large-scale management experiments and learning by doing. *Ecology* 71:2060-2068.
- Williams BK. 2003. Policy, research and adaptive management in avian conservation. *Auk* 120:212-217.



2

INTRODUCTION

The Central Valley Joint Venture 2020 Implementation Plan (“the Plan”) establishes integrated conservation objectives for major groups of birds: non-breeding waterfowl, breeding waterfowl, non-breeding shorebirds, breeding shorebirds, breeding and non-breeding waterbirds, breeding riparian landbirds and breeding grassland-oak savannah landbirds. The Plan also presents a framework for setting conservation objectives for all Central Valley bird species that are at particularly high risk of population decline (at-risk bird species).

The Central Valley’s nine drainage basins served as planning regions in the 1990 and 2006 Implementation Plans. This 2020 Plan combines some of these basins for a total of five planning regions, which together comprise the Plan’s Primary Focus Area. The American, Butte, Colusa and Sutter Basins now comprise the Sacramento planning region, while the Yolo and Delta Basins comprise the Yolo-Delta planning region. The Suisun Marsh, San Joaquin and Tulare Basins are maintained as separate planning regions (Figure 3.1). This Plan also includes a Secondary Focus Area that encompasses the foothills surrounding the Valley floor and generally extends to the crests of surrounding watersheds.

The first part of this chapter presents the Central Valley Joint Venture (CVJV) integrated 10-year habitat objectives across bird groups, for the Central Valley as a whole and for each planning region. The second part of the chapter summarizes the habitat objectives for each bird group. The chapter concludes with the results of a scenario planning exercise and examines how scenario planning will be used to maximize the CVJV’s progress toward meeting its objectives under different future scenarios.

(1) Snow geese - Jeff McCreary (2) Recently-fledged yellow warbler in riparian habitat - Tom Grey

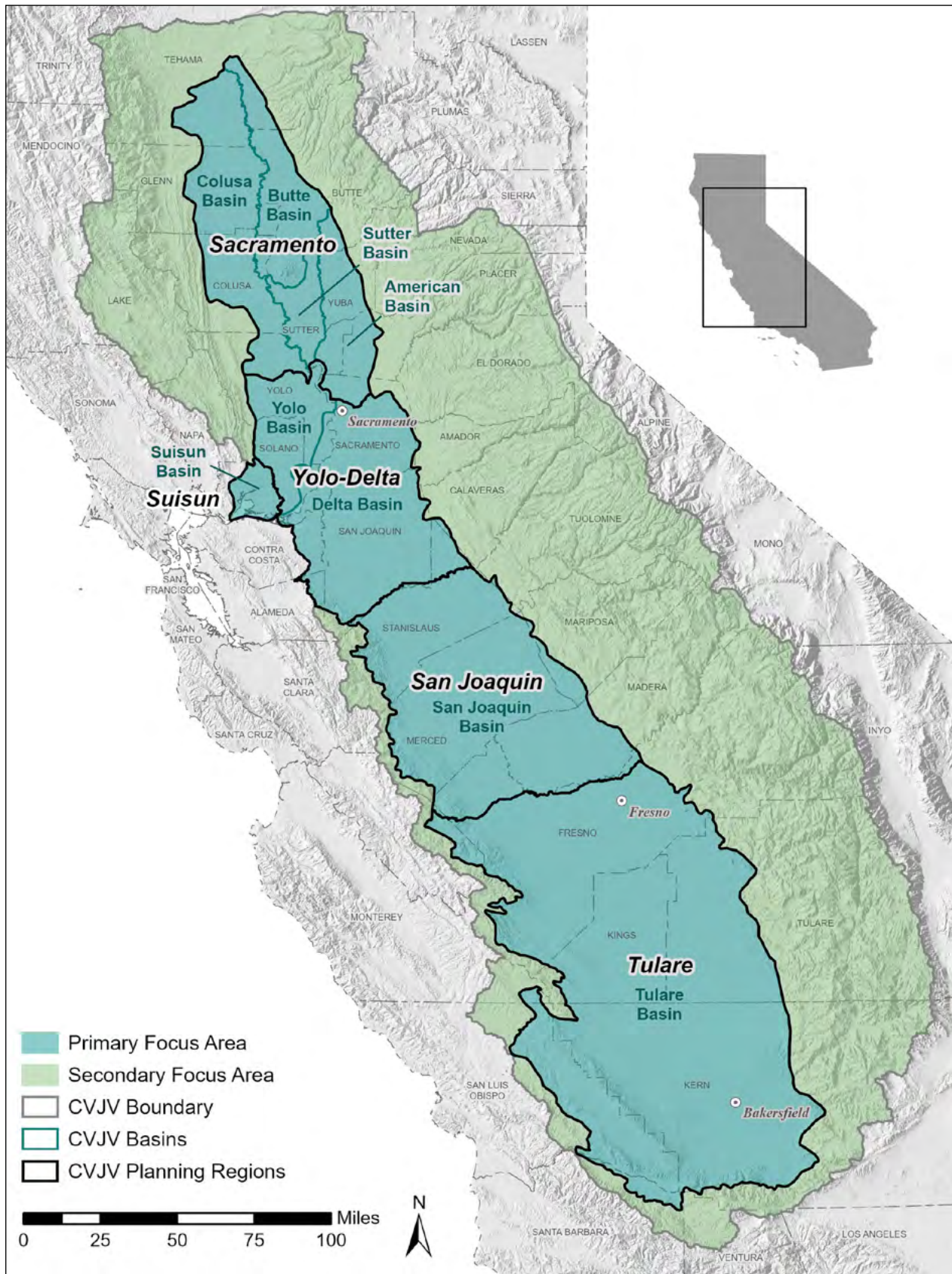

FIGURE 3.1 CVJV planning regions, basins, Primary and Secondary Focus Areas, and counties.

INTEGRATED BIRD HABITAT OBJECTIVES

Habitat objectives for each bird group were developed independently as part of the Plan revision process, yet the habitat needs of different bird groups frequently overlap. Meeting habitat objectives for one bird group may partially or wholly meet the needs of other bird groups. Identifying these areas of overlap increases the efficiency of all bird habitat conservation, and it points to the benefits of an integrated set of habitat objectives. The CVJV identified four conservation approaches that were associated with two or more bird groups and thus, were integrated when establishing habitat objectives: restoration of managed semi-permanent wetlands, restoration of managed seasonal wetlands, restoration of riparian habitat, and maintenance of existing winter-flooded rice and grain corn. Habitat objectives associated with wetland enhancement and with agricultural easements in the grassland and oak savannah habitats were not subject to the process of integration, as they were only associated with a single bird group. Nevertheless, these latter objectives are included when summarizing the integrated habitat objectives for each planning unit and for the Central Valley as a whole.

One complicating factor that the CVJV is trying to reconcile is the importance of grassland or other upland habitat, such as beneficial agriculture, associated with managed semi-permanent wetlands. Many waterfowl build nests in upland habitat. Therefore, semi-permanent wetlands without associated uplands will likely not contribute to achieving breeding waterfowl objectives and may possibly complicate recovery of breeding duck numbers. The relationship of life cycle requirements and different habitats can be complex for some species. This complication demonstrates not only the importance of key habitat types, but also the importance of proximity of different habitat types to each other for life stages such as nesting (upland) and brood-rearing (wetland).

The CVJV used the following process to integrate bird needs for each of the four conservation approaches. First, all bird groups associated with a given habitat objective were identified. For example, objectives for managed semi-permanent wetlands were established for breeding waterfowl, breeding shorebirds, non-breeding shorebirds and breeding waterbirds. Second, the bird group with the largest acre objective served as the integrated objective. For example, the objective for semi-permanent wetlands in the Sacramento planning region ranges from a high of 9,420 acres for breeding waterfowl, to just 228 acres for breeding waterbirds (see

Tables 3.9 and 3.12). Thus, the managed semi-permanent wetland objective associated with breeding waterfowl was adopted as the integrated objective for this planning region, since meeting this objective would presumably satisfy the need of all bird groups. Integrated habitat objectives for the Central Valley as a whole and for each planning region are presented in Tables 3.1 through 3.6.

CENTRAL VALLEY-WIDE HABITAT OBJECTIVES BY HABITAT TYPE

HABITAT	OBJECTIVE (ACRES)
Managed Semi-Permanent Wetlands	34,368
Managed Seasonal Wetlands	20,004
Riparian Habitat	33,332
Winter-Flooded Rice ^a	340,670
Grassland ^b	10,337
Oak Savannah	8,483
Wetland Enhancement ^c	17,963
Agricultural Easements	54,000

^a Annual objective reflects the CVJV's desire to maintain the existing amount of winter-flooded rice (see Non-Breeding Waterfowl chapter).

^b Acre objective is for the Secondary Focus Area. Objective for Primary Focus Area is to maintain existing grassland habitat (see Breeding Grassland-Oak Savannah Landbirds chapter).

^c Annual wetland enhancement objective when wetland restoration objectives are met. This objective assumes that the infrastructure of managed seasonal wetlands requires some form of maintenance, on average, every 12 years.

TABLE 3.1 Integrated habitat objectives for the Central Valley as a whole.

HABITAT OBJECTIVE	ACRES
Managed Semi-Permanent Wetlands	9,420
Managed Seasonal Wetlands	6,875
Riparian Habitat	8,377
Winter-Flooded Rice ^a	324,847
Wetland Enhancement ^b	6,256
Agricultural Easements (Rice)	54,000

^a Annual objective reflects the CVJV's desire to maintain the existing amount of winter-flooded rice (see Non-Breeding Waterfowl chapter).

^b Annual wetland enhancement objective when wetland restoration objectives are met. This objective assumes that the infrastructure of managed seasonal wetlands requires some form of maintenance, on average, every 12 years.

TABLE 3.2 Integrated habitat objectives for the Sacramento planning region.

HABITAT OBJECTIVE	ACRES
Managed Semi-Permanent Wetlands	7,160
Managed Seasonal Wetlands	4,500
Riparian Habitat	5,906
Winter-Flooded Rice ^a	15,823
Wetland Enhancement ^b	2,196

^a Annual objective reflects the CVJV's desire to maintain the existing amount of winter-flooded rice (see Non-Breeding Waterfowl chapter).

^b Annual wetland enhancement objective when wetland restoration objectives are met. This objective assumes that the infrastructure of managed seasonal wetlands requires some form of maintenance, on average, every 12 years.

TABLE 3.3 Integrated habitat objectives for the Yolo-Delta planning region.

HABITAT OBJECTIVE	ACRES
Managed Semi-Permanent Wetlands	1,355
Riparian Habitat	1,408
Wetland Enhancement ^a	2,386

^a Annual wetland enhancement objective when wetland restoration objectives are met. This objective assumes that the infrastructure of managed seasonal wetlands requires some form of maintenance, on average, every 12 years.

TABLE 3.4 Integrated habitat objectives for the Suisun planning region.

HABITAT OBJECTIVE	ACRES
Managed Semi-Permanent Wetlands	9,378
Managed Seasonal Wetlands	5,837
Riparian Habitat	8,368
Wetland Enhancement ^a	5,330

^a Annual wetland enhancement objective when wetland restoration objectives are met. This objective assumes that the infrastructure of managed seasonal wetlands requires some form of maintenance, on average, every 12 years.

TABLE 3.5 Integrated habitat objectives for the San Joaquin planning region.

HABITAT OBJECTIVE	ACRES
Managed Semi-Permanent Wetlands	7,055
Managed Seasonal Wetlands	2,792
Riparian Habitat	9,273
Wetland Enhancement ^a	1,795

^a Annual wetland enhancement objective when wetland restoration objectives are met. This objective assumes that the infrastructure of managed seasonal wetlands requires some form of maintenance, on average, every 12 years.

TABLE 3.6 Integrated habitat objectives for the Tulare planning region.



Protected waterfowl habitat in Suisun Marsh – Robert Eddings

HABITAT OBJECTIVES BY BIRD GROUP

The integrated habitat objectives were derived from habitat objectives established for each bird group. These habitat objectives were established by planning region (Table 3.7) with the exception of non-breeding shorebirds and breeding grassland-oak savannah landbirds, for which objectives are established for the Central Valley as a whole. The Plan establishes long-term objectives for a 100-year period for all non-waterfowl bird groups, representing the ultimate conditions necessary to sustain bird populations. Short-term objectives that correspond to the 10-year life of the Plan are also established. These short-term objectives correspond to 10 percent of the 100-year objective. Unless otherwise stated, objectives associated with each habitat type reflect a desired increase in the amount of this habitat.

ning regions (Table 3.8). In addition to restoration, which creates new acres of wetlands, enhancement of existing wetlands is also needed. Proper water management is critical to producing large amounts of food in seasonal wetlands. Water control structures, such as the levees and ditch networks that are used to manage water levels, must be periodically repaired or enhanced to maintain or improve food production. The CVJV assumes that managed seasonal wetlands need some form of intense habitat and infrastructure enhancement, on average, every twelve years to maintain the level of productivity assumed in the CVJV model. As a result, wetland enhancement objectives are expressed perpetually as one-twelfth of the total wetland acres. Note that, as more acres of wetland are restored, that creates more acres requiring

FOCUS AREA	PLANNING REGION	BASIN	NON-BREEDING WATER-FOWL	BREEDING WATER-FOWL	NON-BREEDING SHORE-BIRDS	BREEDING SHORE-BIRDS	NON-BREEDING WATER-BIRDS	BREEDING WATER-BIRDS	RIPARIAN LAND-BIRDS	AT-RISK SPECIES	GRASSLAND-OAK SAVANNAH LANDBIRDS
Primary Focus Area	Sacramento	American									
		Butte	•	•		•	•	•	•	•	
		Colusa			•						
		Sutter									
	Yolo-Delta	Yolo	•	•		•	•	•	•	•	
		Delta									•
	Suisun	Suisun	•	•	N/O	N/O	•	•	N/O	•	
	San Joaquin	San Joaquin	•	•		•	•	•	•	•	
Tulare	Tulare	•	•	•	•	•	•	•	•		
Secondary Focus Area			N/O	N/O	N/O	N/O	N/O	N/O	N/O	N/O	•

N/O: No objectives

TABLE 3.7 Scale at which habitat objectives are established for each bird

Non-Breeding Waterfowl

The non-breeding waterfowl bird group includes migrating and wintering ducks and geese that rely on Central Valley habitats between August and March. The habitat objectives for this bird group reflect the landscape conditions necessary to support duck populations at North American Waterfowl Management Plan (NAWMP) goals. The habitat objectives listed for non-breeding waterfowl in this summary chapter correspond to 25 percent of the wetland objectives established in the Non-Breeding Waterfowl chapter. Twenty-five percent was deemed a reasonable number to be achieved over the 10-year life of the Plan.

Restoration objectives for seasonal wetlands over the life of the 2020 Plan total 17,292 acres and vary widely among plan-

periodic enhancement. Annual (perpetual) wetland enhancement objectives for the Central Valley total 17,738 acres once the 10-year wetland restoration objectives have been met.

The agricultural enhancement objective for non-breeding waterfowl is divided into two sub-objectives: the amount of winter-flooded rice and grain corn that is available annually, and the permanent protection of agricultural habitats. The CVJV's objective is to maintain the 340,670 acres of winter-flooded rice and 34,408 acres of non-deep plowed grain corn that is now available to waterfowl, and in addition, to permanently protect 54,000 acres of riceland through conservation easements. These riceland easements reflect a desire to permanently protect 10 percent of the planted rice base over the life of the 2020 Plan.

CONSERVATION APPROACH

PLANNING REGION	MANAGED SEASONAL WETLAND RESTORATION	MANAGED SEASONAL WETLAND ENHANCEMENT	AGRICULTURAL HABITAT ^a	AGRICULTURAL HABITAT PROTECTION
Sacramento	6,875	6,256	324,847 WFR 7,406 GC	54,000 (Rice)
Yolo-Delta	4,500	2,196	15,823 WFR 27,002 GC	0
Suisun	NA	2,386	NA	NA
San Joaquin	3,125	5,105	NA	NA
Tulare	2,792	1,795	NA	NA
Central Valley Total	17,292	17,738	340,670 WFR 34,408 GC	54,000 (Rice)

^a Annual objectives that reflect the CVJV's desire to maintain the amount of winter-flooded rice and harvested grain corn currently available to non-breeding waterfowl.

WFR: Winter-Flooded Rice

GC: Grain Corn

NA: Not Applicable

TABLE 3.8 CVJV Primary Focus Area habitat objectives (acres) for non-breeding waterfowl over the intended life of this Plan.

Breeding Waterfowl

Habitat objectives for breeding waterfowl are focused primarily on increasing the acreage of managed semi-permanent wetlands (Table 3.3). The objective is to increase the acres of managed semi-permanent wetlands by an amount that is equal to 20 percent of all existing managed wetlands in the Central Valley (that is, 20 percent of the combined total of existing managed seasonal and semi-permanent wetlands). It should be noted that the Breeding Waterfowl chapter of this Plan also includes objectives for associated uplands (for nesting), but these upland acres are not shown in Table 3.9.

PLANNING REGION

	MANAGED SEMI-PERMANENT WETLANDS
Sacramento	9,420
Yolo-Delta	1,183
Suisun	1,355
San Joaquin	9,378
Tulare	0
Total	21,336

TABLE 3.9 Managed semi-permanent wetland objectives (acres) for breeding waterfowl in each planning region and for the Central Valley as a whole.

Non-Breeding Shorebirds

The non-breeding shorebirds group includes migrating and wintering birds that reside in the Central Valley between July and May. Habitat objectives for non-breeding shorebirds are specific to managed wetlands, regardless of whether these wetlands are managed as seasonal or semi-permanent habitats (that is, both habitat types can meet the needs of this bird group). These objectives have been further defined as managed wetlands that provide areas of open water four inches or less in depth. Part of the challenge of meeting the habitat needs of non-breeding shorebirds is that large numbers of birds are present during periods of time when, due to traditional land management practices, few wetlands or other habitat types are available. For example, peak populations of non-breeding shorebirds in the Central Valley occur in late April, when most seasonally managed wetlands are dry. Habitat objectives for this bird group reflect the time periods when habitats are in short supply (Table 3.10).

NON-BREEDING SHOREBIRDS

	MID-MARCH THROUGH APRIL	LATE JULY THROUGH SEPTEMBER
CVJV Primary Focus Area	11,594	5,337

TABLE 3.10 Managed seasonal and semi-permanent wetland objectives (acres) for non-breeding shorebirds.

Breeding Shorebirds

Habitat objectives for breeding shorebirds are focused exclusively on increasing the amount of managed semi-permanent wetlands (Table 3.11). Other types of wetlands could contribute to breeding shorebird habitat objectives, such as reverse-cycle wetlands that are flooded in spring and summer and managed with relatively shallow water.

PLANNING REGION	BREEDING SHOREBIRDS	
	Managed Semi-Permanent Wetlands	
Sacramento	7,023	
Yolo-Delta	7,159	
Suisun	0	
San Joaquin	7,272	
Tulare	7,055	
Total	28,508	

TABLE 3.11 Managed semi-permanent wetland objectives (acres) for breeding shorebirds in each planning region and for the Central Valley as a whole.

Breeding Waterbirds

Waterbirds in the Central Valley are represented in the Plan by a suite of 10 focal species that reflect the diversity of waterbird species that use the region for nesting, foraging and roosting. Habitat objectives for breeding waterbirds are presented in Table 3.12.

PLANNING REGION	BREEDING WATERBIRDS	
	Managed Semi-Permanent Wetlands	Riparian Habitat
Sacramento	228	213
Yolo-Delta	228	213
Suisun	228	141
San Joaquin	796	425
Tulare	796	425
Total	2,276	1,417

TABLE 3.12 Habitat objectives (acres) for breeding waterbirds in each planning region and for the Central Valley as a whole.

Non-Breeding Waterbirds

Habitat objectives for non-breeding waterbirds are presented in Table 3.13.

NON-BREEDING WATERBIRDS

	Managed Seasonal Wetlands	Winter-Flooded Rice	Postharvest-Flooded Corn
Sacramento	6,849	391,395	0
Yolo-Delta	2,195	20,690	5,280
Suisun	2,876	NA	NA
San Joaquin	5,837	NA	NA
Tulare	1,884	NA	NA
Total	19,641	412,085	5,280

NA: Not Applicable

TABLE 3.13 Habitat objectives (acres) for non-breeding waterbirds in each planning region and for the Central Valley as a whole.

Breeding Riparian Landbirds

Riparian landbirds are represented in the Plan by 12 focal species that reflect the suite of species and habitat types used by the full complement of riparian landbirds found in the Central Valley. Habitat objectives for breeding riparian landbirds are focused exclusively on increasing the amount of riparian habitat (Table 3.14).

PLANNING REGION	RIPARIAN HABITAT
Sacramento	8,377
Yolo-Delta	5,906
San Joaquin	8,368
Tulare	9,273
Total	31,924

TABLE 3.14 Riparian habitat objectives (acres) for breeding riparian landbirds in each planning region and for the Central Valley as a whole.



Riparian habitat restoration – Massimiliano Sonogo, Point Blue Conservation Science

Breeding Grassland-Oak Savannah Landbirds

The habitat objectives for breeding grassland-oak savannah landbirds focus on 12 bird species that breed in grassland and oak savannah ecosystems and that represent a broad range of life histories and a continuum of specific habitat needs. Habitat objectives for breeding grassland-oak savannah landbirds are presented in Table 3.15. These objectives can be met anywhere in the Central Valley (except the Suisun Marsh, which does not naturally contain these habitats).

FOCUS AREA	GRASSLAND (<10% canopy)	OAK SAVANNAH (10-40% canopy)
Primary Focus Area	0 ^a	8,483
Secondary Focus Area	10,337	0 ^b
Total	10,337	8,483

^a The long-term habitat objective for grasslands in the Primary Focus Area is to maintain the current extent, with no net loss (see Breeding Grassland-Oak Savannah Landbird chapter).

^b The long-term habitat objective for oak savannah in the Secondary Focus Area is to maintain the current extent, with no net loss.

TABLE 3.15 Habitat objectives (acres) for breeding grassland-oak savannah landbirds in each focus area and for the Central Valley as a whole.



Waterfowl hunters - California Waterfowl Association



Grassland habitat near the South Fork American River - photo by American Rivers

SCENARIO PLANNING

The habitat objectives presented in this chapter reflect the best available science. Yet, this science does not fully inform the broad strategic choices the CVJV will face in pursuit of these habitat objectives. The 16 years that elapsed between the 1990 and 2006 plans were highly favorable for bird habitat conservation in the Central Valley. Many landowners took advantage of new public programs that funded wetland restoration on private lands and more than 65,000 acres of additional managed wetlands were protected during this period. During the same time period, winter flooding of harvested rice fields increased from an estimated 60,000-80,000 acres in the 1980s to more than 350,000 acres by 2006 (CVJV 2006). The 2006 CVJV Implementation Plan assumed that the conservation opportunities that had characterized the 1990s and early 2000s would continue. However, rising commodity prices and increasing land values have reduced wetland restoration opportunities on private lands since 2006. The recent California drought severely limited surface water supplies for managed wetlands and winter-flooded rice and revealed the vulnerability of these habitats to future water shortages (Petrie et al. 2016). This combination of declining wetland restoration opportunities and less water made it more difficult to achieve net gains in bird habitat acreage in recent years.

This 2020 Plan identifies the landscape characteristics (habitat of sufficient quality, quantity and distribution) needed to support bird populations at desired levels, and it establishes integrated habitat objectives aimed at creating these desired landscape conditions. While this approach provides a vision of what the Central Valley would look like from a bird and conservation perspective, future progress toward this desired landscape may be uncertain given the lessons of the past decade. Opportunities for conservation will likely change over the life of this Plan, so planning efforts must anticipate this uncertainty. The challenge is to identify what factors influence conservation opportunities in the Central Valley, recognize when these factors change for better or worse, and adjust or prioritize actions accordingly.

Scenario planning is an excellent tool for acknowledging uncertainty rather than trying to reduce or eliminate it. It can help resource managers generate creative approaches, thinking outside the historical and most obvious trends to incorporate uncertainty as a factor in prioritizing management actions. Scenario planning can help managers identify the most uncertain and most worrisome drivers of change, then enable them to plan around these drivers by putting them into a context of more known (or knowable) drivers (Moore et al. 2013).

CVJV partners participated in scenario planning workshops as part of the development of this Plan. The overarching goal of the workshops was to identify the conservation actions that allow the CVJV to maximize progress toward its integrated bird habitat objectives, regardless of the challenges that are likely to arise over the life of the Plan. Participants identified conservation opportunities and water availability as the two factors most likely to determine the CVJV's progress toward its integrated bird habitat objectives.

Conservation opportunities in the Central Valley are generally a function of three factors: public support of and funding for conservation, the cost of protecting land and implementing conservation actions, and the number of waterfowl hunters. Workshop participants assumed that the cost of protecting land is largely dependent on commodity prices and patterns of urban development, while public support for conservation can be indexed by the public financial resources available for habitat restoration and enhancement. The number of waterfowl hunters is an important component of conservation opportunity because land owned by private duck clubs accounts for two thirds of all managed wetlands in the Central Valley. Without this constituency, the opportunity to increase the quality of managed wetlands or add to the base of existing managed wetlands would be greatly reduced.

Water availability is driven by the annual variation in the water supply available for wetland-dependent bird habitat. Water supply is largely a function of annual precipitation, Sierra Nevada snowpack, existing reservoir storage and the needs of endangered fish species, agricultural producers and urban water users.

After identifying these two key drivers, workshop participants defined four possible scenarios that represent different combinations of conservation opportunity and water availability (Figure 3.2). Each of these scenarios occupy a quadrant on the figure. They are named and described in detail below.

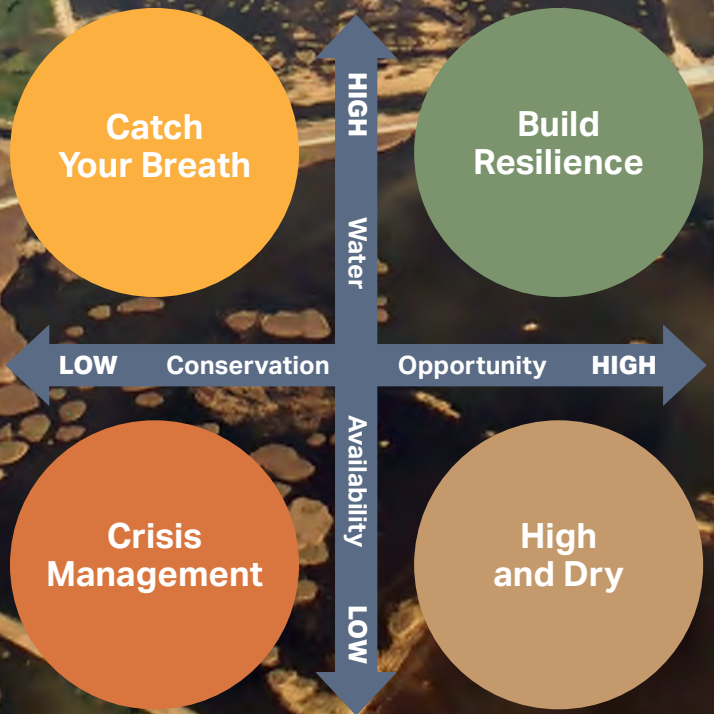
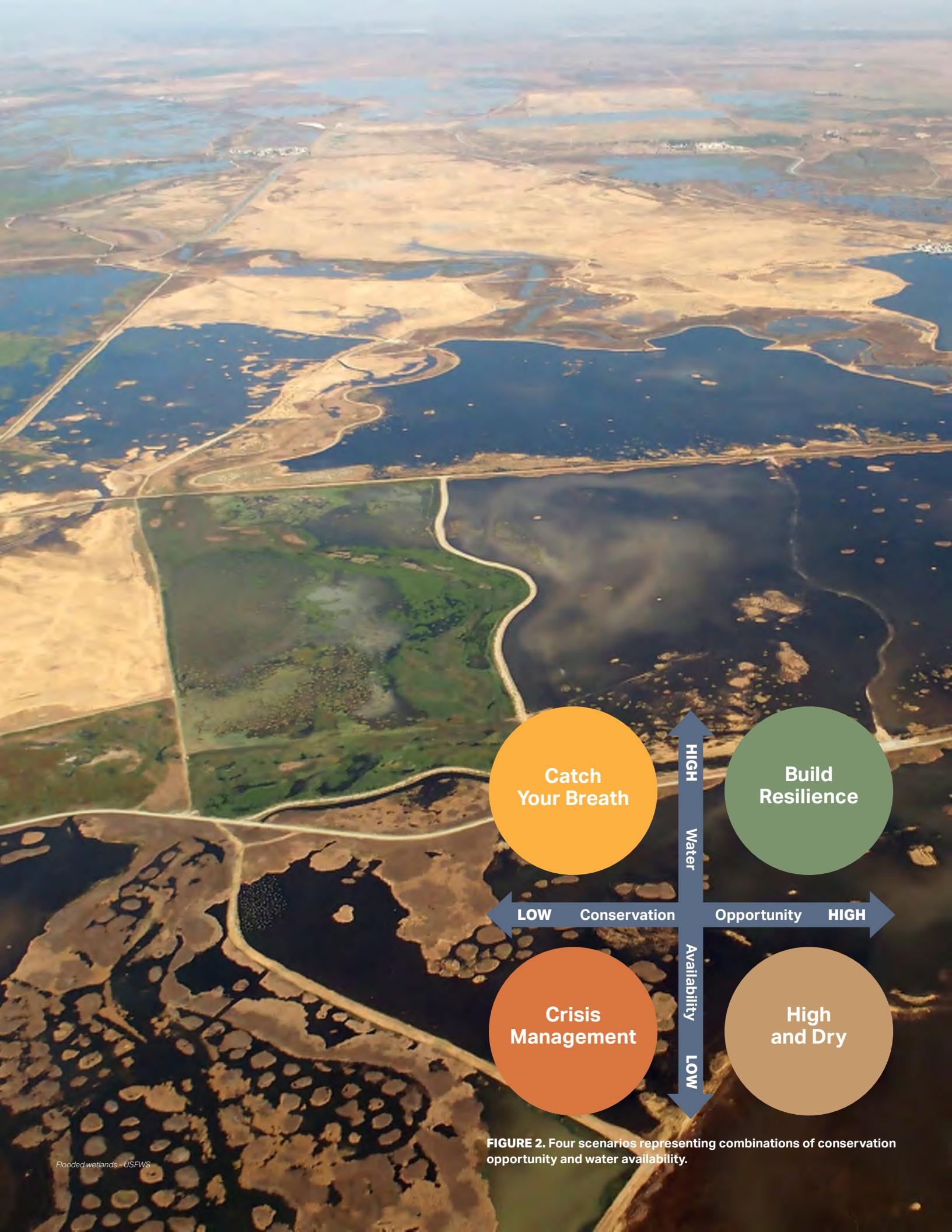

FIGURE 2. Four scenarios representing combinations of conservation opportunity and water availability.

IDENTIFYING PRIORITY CONSERVATION ACTIONS FOR EACH SCENARIO

The last task of the scenario planning process was to identify conservation strategies and actions the CVJV can consider under each potential future scenario. Through stakeholder interviews, workshops and facilitated CVJV Management Board discussions, the CVJV identified a suite of high-priority conservation strategies that it will pursue to achieve the Plan's habitat objectives (Table 3.16). The CVJV identified four categories – water management, land management and conservation, funding and budgets, and the human dimension of conservation – and identified key strategies within each category that could be applied, depending on which scenario is in effect. The CVJV also created an extensive list of conservation actions. Through an annual work planning process, the Management Board will determine which scenario the Valley or specific planning regions are in, then working groups will develop a specific set of prioritized conservation actions for partners to undertake.

Below each scenario are simple examples of means to implement the strategies under each scenario. The strategies and actions fall into one of two broad categories: maximizing progress in meeting the CVJV's habitat objectives when the opportunity to do so exists and minimizing the impact on bird populations when the conservation opportunities and general condition of Central Valley habitats are unfavorable. These are broad, high-level actions that help demonstrate how scenario planning could be used by the CVJV; they are far from complete. More specific actions that are tailored to each scenario will need to be developed, including actions that implementers would have no regrets taking in any scenario.

Scenario A: “Building Resilience”

High Conservation Opportunity & High Water Availability

Under this scenario, surface water supplies are sufficient to properly manage all the habitat required by wetland-dependent birds in the Central Valley. All Central Valley Project Improvement Act (CVPIA) refuges have full access to Level 4 CVPIA water supplies (see Water subchapter for an explanation of CVPIA water supplies), while publicly- and privately-managed wetlands also have access to sufficient and affordable surface water supplies, including for summer irrigation treatments. Water supplies do not limit the amount of rice that is traditionally planted, and the cost of water makes winter flooding the most economical means of decomposing rice straw.

Because of the large number of willing agricultural land sellers, the opportunity to acquire land for habitat restoration is high. Moreover, there are adequate public and private financial resources available to fully capitalize on these opportunities. Funding is also available to purchase permanent water rights, and to improve water use efficiency through improvements to water conveyance infrastructure. Government agency conservation budgets are robust, and habitat management staff is available to optimally manage most public lands. Similarly, managers of private wetlands (e.g., waterfowl clubs) are highly motivated to improve their properties, and the supportive funding needed for these improvements is generally available.

Prioritized Strategy

Pursue habitat objectives that relate to restoration and agricultural easements, given the abundance of willing sellers. Enhancing existing bird habitats is a secondary priority in this scenario.

Priority would be placed on purchasing permanent water rights, especially in parts of the Central Valley that are disproportionately affected during periods of drought.

Scenario B: “High and Dry”

High Conservation Opportunity & Low Water Availability

Under this scenario, surface water supplies are insufficient to flood and properly manage all the habitat required by wetland-dependent birds in the Central Valley. Water storage reservoirs are well below average levels and competition among water users is severe. The CVPIA refuges, which include publicly-managed wetlands as well as the private wetlands in the Grassland Resource Conservation District (GRCD), have access to water supplies well below Level 2 CVPIA water supplies (50 percent reduction or more in average water supplies). Private wetlands outside the GRCD face similar water shortages. In general, water supplies are insufficient to flood all wetland units and little or no summer irrigation occurs. Limited water supplies reduce the amount of planted rice below traditional levels. The high cost and low availability of surface water greatly reduces the amount of winter flooding of harvested rice fields.

Despite water shortages, there are substantial public and private funds available for land acquisition and habitat restoration. In addition, there is growing interest by landowners in retiring agricultural lands because of drought-related financial hardships. Because public conservation programs are generally well funded, there is interest in improving the water and habitat management infrastructure and subsequent quality of managed wetlands to help offset the effects of water shortages.

Prioritized Strategy

Focus on habitat objectives that relate to restoration and agricultural easements, given the abundance of willing sellers. Enhancing existing bird habitats should be a secondary priority at this time.

Invest in short-term management actions that would help offset the effects of reduced water supplies for wetland-dependent birds. For example, invest in programs that help increase food production on those public and private wetland habitats that are likely to receive some water during this period of low water availability.



Levee construction for wetland habitat restoration, Gray Lodge Wildlife Area - Ducks Unlimited, Inc.

Scenario C: “Catch Your Breath”

Low Conservation Opportunity & High Water Availability

Under this scenario, surface water supplies are sufficient to flood and properly manage all the habitat required by wetland-dependent birds in the Central Valley. CVPIA refuges have full access to Level 4 CVPIA water supplies, while privately managed wetlands outside the GRCD have access to affordable surface water supplies, including surface water supplies for summer irrigation treatments. Water supplies do not limit the amount of rice that is traditionally planted, and the low cost of water makes winter flooding the most economical means of decomposing rice straw.

Public and private funds available for conservation are reduced. Moreover, there is little interest by landowners in retiring marginal lands because of strong commodity prices. Government agency budgets are weak, and staff and funding are insufficient to improve public lands. Similarly, there is little funding available to improve the wetland and water management infrastructure, or other enhancement cost-sharing actions to offset the annual costs of producing food for waterfowl on these properties.

Prioritized Strategy

Focus limited resources on the enhancement of existing bird habitats, since there is little opportunity to add to the existing habitat base during this scenario.

Work to increase the level of funding for public programs that are important to meeting the CVJV’s habitat objectives.

Scenario D: “Crisis Management”

Low Conservation Opportunity & Low Water Availability

Under this scenario, surface water supplies are insufficient to flood and properly manage much of the habitat required by wetland-dependent birds in the Central Valley. Storage reservoirs are well below average levels and competition among water users is severe. CVPIA refuges have access to water supplies well below Level 2 CVPIA water supplies (greater than a 50 percent reduction in average water supplies), while private wetlands outside the GRCD face similar water shortages. In general, water supplies are insufficient to flood all wetland units and little or no summer irrigation occurs. Water supplies reduce the amount of planted rice below traditional levels, and the high cost and low availability of surface water greatly reduces the amount of winter-flooding of harvested rice fields.

Although there may be increased interest by landowners in retiring agricultural lands because of drought-related hardships, there is little public or private funding available to capitalize on these opportunities. Because government agency conservation budgets are weak, staff and funding are unavailable to make improvements on public lands or manage public lands in ways that might help offset the effects of less water. Similarly, there is little funding available to improve the management infrastructure on duck clubs or to offset the annual costs of producing food for waterfowl on these properties.

Prioritized Strategy

Work to increase the level of funding for those public programs that are important to meeting the CVJV’s habitat objectives.

Invest in short-term management actions to help offset the effects of reduced water supplies for wetland-dependent birds. For example, invest in programs that help increase food production on those public and private wetland habitats that are likely to receive some water during this period of low water availability.

Focus limited resources on the enhancement of existing bird habitats, since there is little opportunity to add to the existing habitat base during these times.

OPERATIONALIZING SCENARIO PLANNING

Scenario planning can allow CVJV partners to rapidly incorporate new or emerging information, keeping the Plan fresh, relevant and in active use. On a regular basis, the Management Board will assess which scenario the CVJV is in. This assessment will be done for the Central Valley as a whole as well as for individual planning regions if necessary. If the Board finds a shift from one scenario to another has occurred, the Board or working groups will identify and prioritize conservation actions most relevant to the new scenario. These actions are likely to be highly specific, consistent with and expanding upon the broader actions described above.

The prioritized conservation actions will be in alignment with the priority strategies shown in Table 16. The Board will also review existing tools and programs, evaluating their suitability and effectiveness to support the priority actions. If no existing tool or program exists to support an action, the Board will develop a strategy to provide one.

Continue to the next page for Table 3.16

LITERATURE CITED

- [CVJV] Central Valley Joint Venture. 2006. Central Valley Habitat Joint Venture Implementation Plan – Conserving bird habitat. U.S. Fish and Wildlife Service. Sacramento, CA.
- Moore SS, Seavy NE, Gerhart M. 2013. Scenario planning for climate change adaptation: A guidance for resource managers. Point Blue Conservation Science and California Coastal Conservancy.
- Petrie MJ, Fleskes JP, Wolder MA, Isola CR, Yarris GS, Skalos DA. 2016. Potential effects of drought on carrying capacity for wintering waterfowl in the Central Valley of California. *J Fish Wildl Manag.* 7(2):408. Available from: <https://www.fwspubs.org/doi/pdf/10.3996/082015-JFWM-082>

CATEGORY	KEY STRATEGIES
WATER MANAGEMENT: Ensure effective management of reliable water supply of sufficient quality and quantity to meet CVJV conservation objectives.	
Water acquisition	Engage in water policy and management actions to promote annual and long-term acquisition – through purchases, transfers or exchanges – of water rights to supply wetland water supplies.
Infrastructure	Promote CVJV priorities in the analysis, planning and implementation of infrastructure programs and projects (including natural infrastructure).
CVPIA	Ensure complete and effective implementation of the environmental provisions of CVPIA, including full delivery of Level 4 water supplies annually.
Groundwater	Ensure that groundwater management addresses habitat water needs and contributions at the local and statewide levels.
Water Supply Insecurity	Predict, prepare and plan for the impacts of long-term water supply insecurities on habitat availability.
Planning	Ensure that local, regional and statewide plans and policies that will potentially affect bird habitat incorporate CVJV water objectives.
LAND MANAGEMENT AND CONSERVATION: Develop, guide and implement land use planning programs and practices to achieve CVJV habitat objectives.	
Protection	Identify important unprotected landscapes and work to permanently protect them through land acquisition and conservation easements.
Restoration and Enhancement	Restore and enhance habitat to meet conservation objectives identified for various bird groups.
Management	Identify, prioritize and implement actions to improve baseline ecological functions and values on existing habitats.
Integrated Planning and Land Use	Integrate CVJV conservation objectives and priorities into local, state and federal land and resource plans.
Agricultural Lands	Develop strategies to maintain sufficient wildlife-friendly agricultural landscapes to meet CVJV conservation objectives.
FUNDING AND BUDGETS: Ensure sufficient, diverse and effectively purposed funding to achieve CVJV conservation objectives.	
Funding Sources	Secure sufficient investments of state, federal and private funding, and safeguard existing funding sources, to fully meet CVJV conservation objectives and needs.
Operations and Maintenance	Regularly assess operation and maintenance needs and gaps on public and private lands; work to establish capacity necessary to meet CVJV conservation objectives.
Financial Sustainability	Regularly assess the scope and financial sustainability of conservation-related funding programs and policies and how they affect achieving CVJV habitat objectives.
HUMAN DIMENSIONS OF CONSERVATION: Identify and engage key partners to help achieve CVJV conservation objectives.	
Key Conservation Partners	Identify key conservation supporters and practitioners who can effectively help the CVJV achieve its conservation objectives.
Actions	Identify actions that will engage conservation supporters and practitioners to achieve CVJV conservation objectives effectively.
Engagement	Engage conservation supporters and practitioners in the work of the CVJV in order to further its conservation objectives.

TABLE 3.16 Priority strategies identified by the CVJV to advance the migratory bird conservation objectives outlined in this Plan.

SECTION II



SETTING THE STAGE



- 4 Environmental, Social and Political Landscape**
 - 4.1 Background** 27
 - 4.2 Water** 41
 - 4.3 Policy** 61
 - 4.4 Climate** 67
 - 4.5 Multiple-Benefit Projects** 73
- 5 Human Dimensions of Bird Conservation** 82



San Luis NWR – Anders Ericsson and Light Hawk

This chapter gives an overview of the environmental, social and political landscape within which the Central Valley Joint Venture (CVJV) operates, including some of the key issues, concerns, trends and opportunities in these areas.

4.1 BACKGROUND

CVJV Geographic Area

The CVJV is divided geographically into a primary and a secondary area of focus (Figure 4.1.1). The Primary Focus Area includes the Central Valley floor and the Carrizo Plain and is largely delineated by the Jepson boundary for the Great Central Valley region (Baldwin et al. 2012). It is composed of nine basins and includes Suisun Marsh. The Secondary Focus Area encompasses the foothills that surround the Valley floor and generally extends to the crests of surrounding watersheds. Each area has its own unique conservation challenges.

In its 1990 and 2006 Implementation Plans, the CVJV's Primary Focus Area was the Central Valley floor, based on a 300-foot elevation limit. Because the focus of these plans was waterfowl and wetlands conservation, prioritizing low elevation areas was sufficient. Since the 2006 Plan, the CVJV has expanded its conservation work to include a broader suite of birds. This 2020 Implementation Plan includes a greater emphasis on landbirds than previous Plans, with an expanded chapter on riparian birds and new chapters on grassland-oak savannah birds and at-risk bird species. As such, planning above the 300-foot elevation limit is important for identifying and improving habitats for these groups of birds. As the CVJV started to work on this Plan revision, it became important to better align the CVJV geographic area with natural ecological boundaries.

In 2016, the CVJV adjusted its boundaries with adjacent Joint Ventures and extended portions of the western boundary into areas not previously covered by any Joint Venture. With this boundary adjustment, the CVJV now encompasses a 50,000-square-mile area, almost 32 million acres, in the heart of California. The area is approximately 440 miles long and averages 115 miles wide, extending from the northern boundary of Tehama County south to the Pine Mountain ridge in Ventura County. The western boundary generally follows the Coast Ranges and includes Suisun Marsh. The eastern boundary follows the crest of the Sierra Nevada, mostly along county boundaries, south to the Tehachapi Mountains.

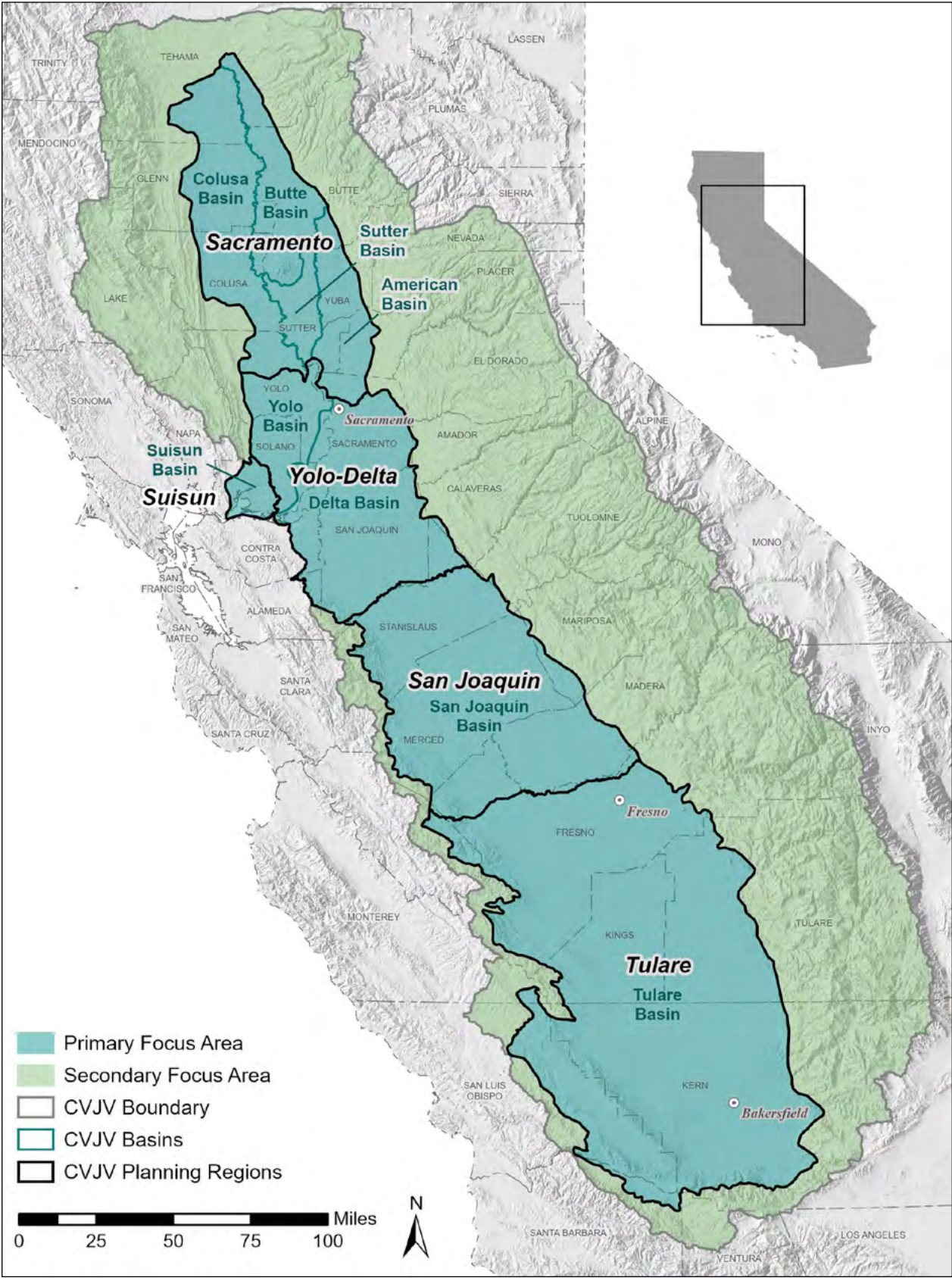

FIGURE 4.1.1 CVJV planning regions, basins, Primary and Secondary Focus Areas, and counties.

Planning Regions and Basins

The CVJV prioritizes conservation efforts within nine planning regions and basins in its Primary Focus Area (Figure 4.1.1). Hydrologic, geologic and floristic information determine basin boundaries. Several of the planning regions consist of a single basin, while two incorporate multiple basins. The foothill ring around the Valley floor defines the Secondary Focus Area planning region. Section III further describes the planning regions, in chapters that address CVJV conservation objectives for specific bird groups. Geography and connectivity of the existing or desired habitat, the distribution of a species within the managed area, and management constraints within these areas play important roles in the designations of planning regions.

Primary Focus Area Overview

The Central Valley of California is the Primary Focus Area of the CVJV. Located in the western portion of the CVJV area, the Valley floor is about 50 miles wide and stretches more than 400 miles down the center of California. The region is bordered mostly by the Coast Ranges in the west and the Sierra Nevada in the east. The area totals approximately 14 million acres, encompasses about 14 percent of the state, and includes portions of 27 counties.

The Central Valley contains California's two largest rivers, the Sacramento in the north and the San Joaquin in the south. These rivers converge in a maze of channels, marshes and islands of the Sacramento-San Joaquin Delta. The waters flow west into Suisun Bay and then San Francisco Bay before reaching the Pacific Ocean. Now predominantly agricultural, the Valley still supports grasslands, marshes, vernal pools, ripar-

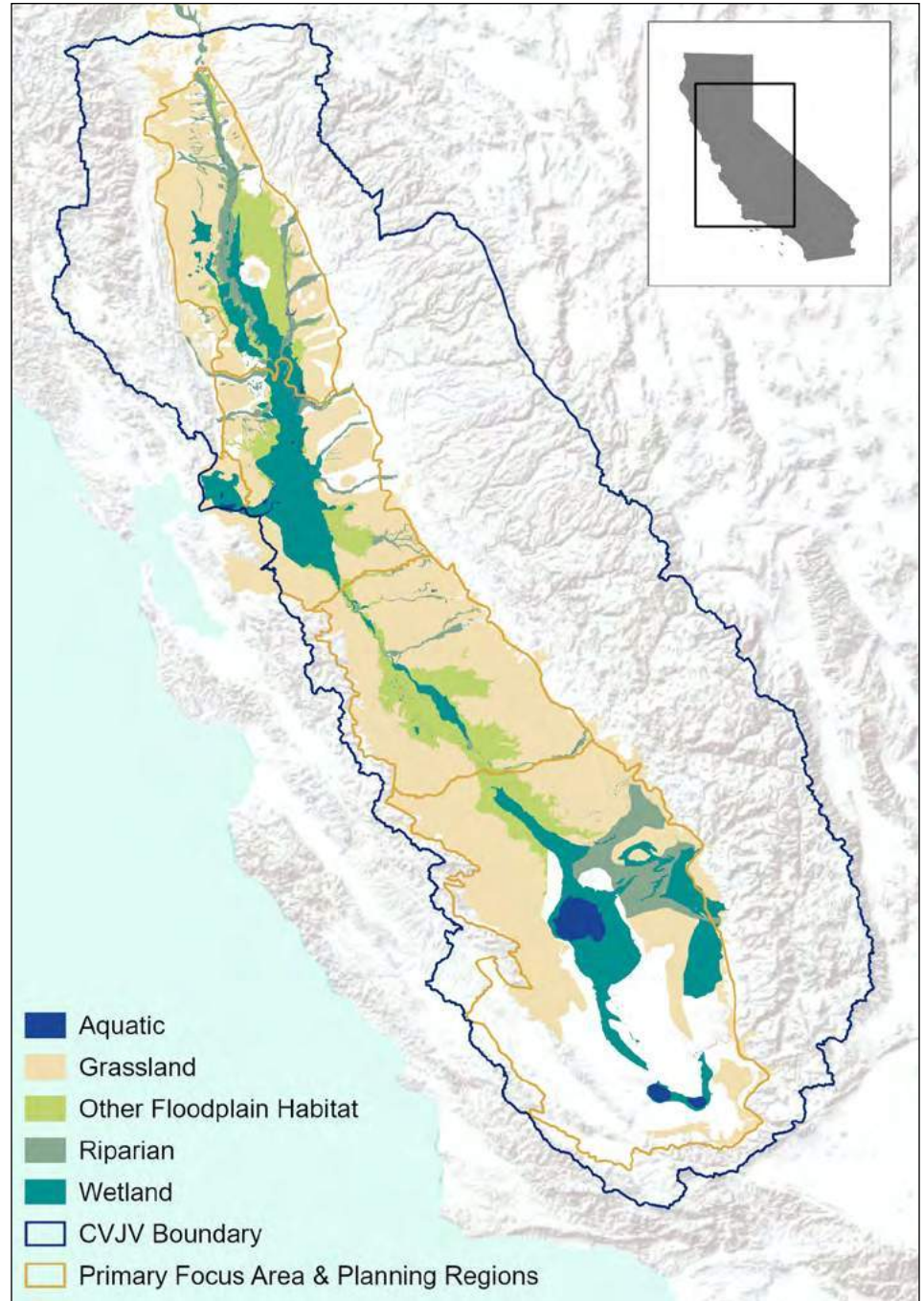

FIGURE 4.1.2A Central Valley wetlands and other significant bird habitat types, Pre-1900s (GIC 2003).

ian woodlands, alkali sink vegetation, and stands of valley oak. Some desert habitat occurs toward the southern end.

The Valley contained an estimated 4 million acres of seasonal and permanent wetland habitats in the 1850s (Dennis et al. 1984) (Figure 4.1.2A).

These wetlands greatly expanded in winter, resulting from over-bank flooding of rivers and streams that inundated large expanses of the Valley during the winter and spring. Most of the wetlands were bordered by grassland and wooded habitats. River and stream corridors provided approximately 1.6 million

acres of riparian habitats throughout the Valley (Warmer and Hendrix 1985).

Reclamation of wetlands throughout the Valley to agriculture in the 19th and early 20th centuries accounts for the largest loss of wetlands. During this time, the Valley became a rich agricultural region, but at the expense of about 95 percent of the Valley’s native wetlands (Dennis et al. 1984) (Figure 4.1.2B). The remnant habitats range from narrow bands of wooded habitats along river and stream corridors to intensively managed wetlands interspersed within intensive agriculture. Today, about 220,000 acres of managed wetlands remain in the Valley; of those, approximately two-thirds are in private ownership. Waterfowl hunting clubs own and manage the majority of Central Valley and Suisun Marsh wetlands as large tracts of waterfowl habitat and for hunting (Frayer et al. 1989).

The Central Valley provides some of the most important bird habitat in North America, hosting one of the largest concentrations of migratory birds in the world during the fall and winter. Acknowledging these bird concentrations, the Western Hemisphere Shorebird Reserve Network designated the Sacramento Valley and the Grasslands Ecological Area (GEA) as internationally important wetland areas. Additionally, the Ramsar Convention designated the GEA as a Ramsar site, a wetland of international importance. Altogether, surveys have documented approximately 400 species of birds in the Central Valley (CVBC 2010).

Primary Focus Area Basin Descriptions

The Sacramento Valley comprises the northern part of the Central Valley and is smaller, wetter, and cooler than the southern part. It contains the Colusa, Butte, Sutter, American, Yolo and Delta

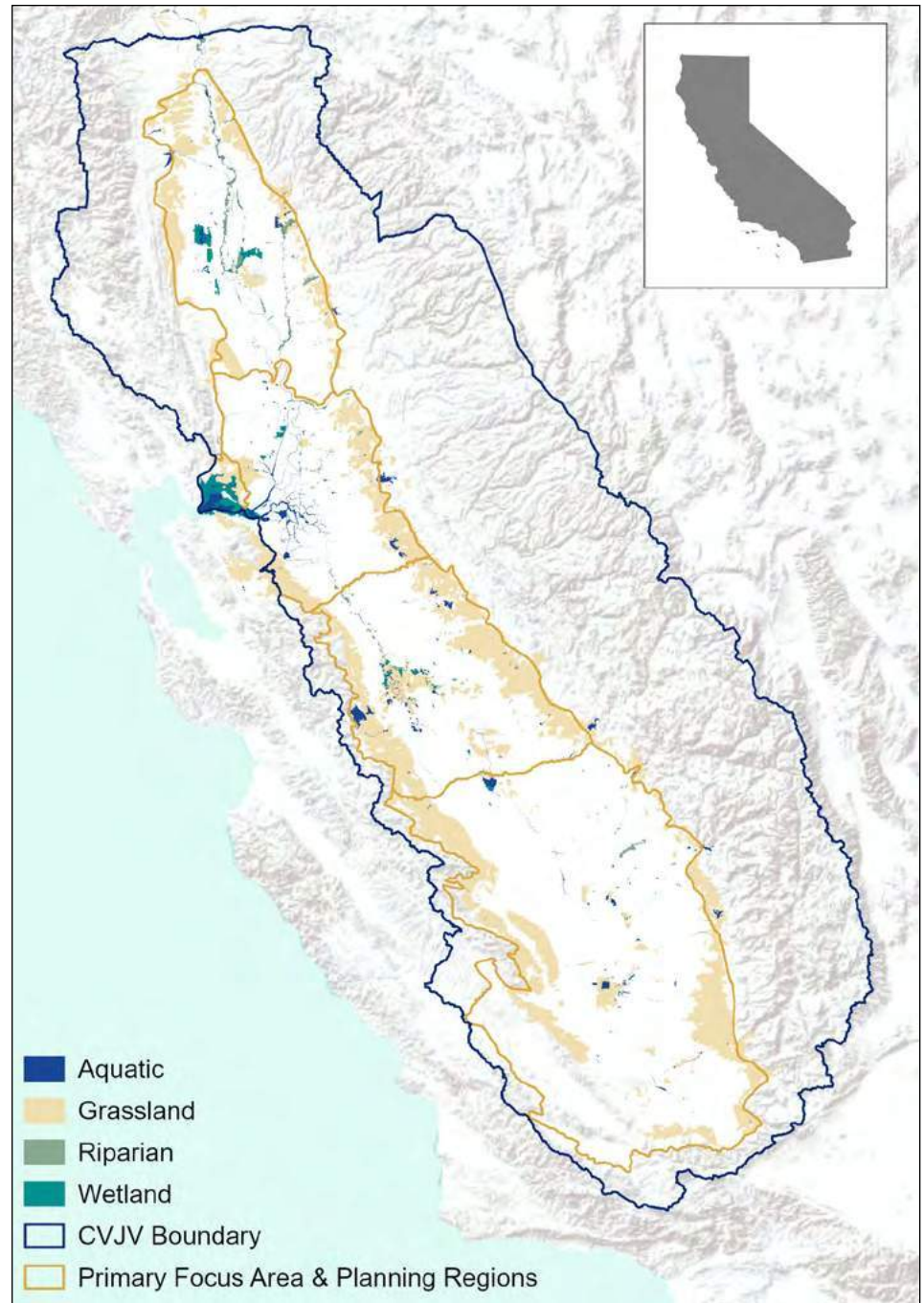

FIGURE 4.1.2B Central Valley wetlands and other significant bird habitat types, 2000s (Petrik et al. 2014).

Basins. Suisun Basin, which encompasses Suisun Marsh, is located between the saltwater marshes of the San Francisco Bay and the freshwater marshes of the Central Valley. The San Joaquin Valley, located in the southern part of the Central Valley, comprises the larger, drier,

hotter area of the Central Valley. It contains the San Joaquin and Tulare Basins.

On the following pages is a brief description of each of the Primary Focus Area basins, listed by its position in the Central Valley from north to south.

Butte Basin

The Butte Basin (Figure 4.1.3) encompasses approximately 608,000 acres and extends 76 miles from Red Bluff south to the Sutter Buttes. The Sacramento River borders the basin on the west, the Sierra Nevada foothills and Feather River on the east. Butte Creek drains the basin between the city of Chico and the Sutter Buttes. Historically, creeks north of Chico flooded adjacent lands. However, these lands were developed for urban and agricultural use and are now protected by levees. Much of the basin is grazing land and prime farmland with walnuts, almonds, and rice being the predominant crops.

Below Chico, over-bank flooding from Butte Creek and the Sacramento River historically produced large tracts of seasonal wetlands. Some of these overflows reached the Butte Sink, a large marsh in the southern portion of the basin. However, in the early 1900s, a series of levees and drainage facilities was built to contain these floodwaters.

Today, most of the properties in the Butte Sink are privately managed waterfowl clubs. They provide extensive habitat for waterfowl, shorebirds, and other waterbirds.

The southwestern part of the basin is managed by the Sacramento River Flood Control District to convey flood flows into the Sutter Bypass. Thermalito Afterbay, in the southeastern portion of the basin, is a large water storage reservoir that helps control flow into the Feather River and serves as a warming basin for agricultural water delivery to rice and other crops west of the Afterbay.

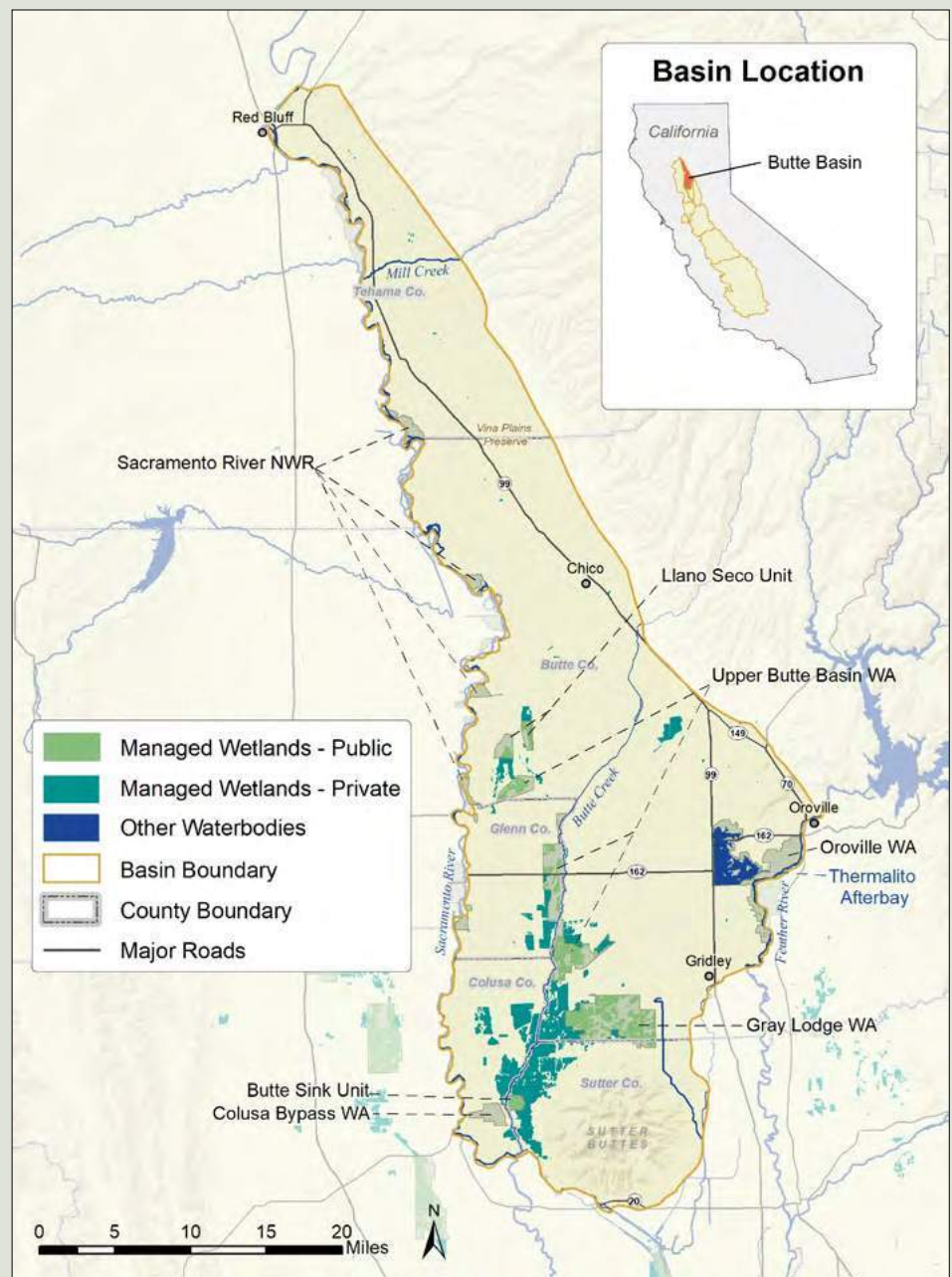

FIGURE 4.1.3 Butte Basin.

Protected natural areas in the basin include portions of The Nature Conservancy-owned Vina Plains Preserve and Sacramento River conservation areas; state-owned Gray Davis Dye Creek Preserve, Upper Butte Basin Wildlife Area (WA), Gray Lodge WA, Oroville WA, and Colusa Bypass WA; and scattered parcels of federally protected wetlands.

Cities and towns include Chico, Oroville, and Gridley.



Butte Sink Wildlife Management Area - Mike Peters

Colusa Basin

The Colusa Basin (Figure 4.1.4) extends 106 miles from Red Bluff south to Cache Creek. The Sacramento River borders the basin on the east, the Coast Range on the west. The basin totals approximately 1,149,000 acres; most wetland habitat is located south of the Stony Creek drainage. Historically, overflow from the Sacramento River joined with streams draining the east slopes of the Coast Range to flood basin marshes in winter and spring. The development of levee networks, drains, and pumping stations have eliminated those flood events in all but the wettest years. Colusa Trough, a naturally formed depression that enters the Sacramento River near Knight's Landing, drains the basin.

Almonds and rice are the predominant agricultural crops grown, with most rice located in the southern half of the basin. Postharvest rice field flooding for straw decomposition provides significant waterfowl habitat in the winter months. Water transfers are a concern, especially if they occur in the winter when water could be used for rice straw decomposition or on private wetlands.

The basin contains extensive private wetlands, most of which are protected by federal conservation easements.

Other protected areas in the basin include the state-owned Thomas Creek Ecological Reserve (ER), Sacramento National Wildlife Refuge (NWR), Delevan NWR, Colusa NWR, and portions of the Sacramento River NWR.

Major cities and towns include Red Bluff, Corning, Orland, Willows, Williams, and Colusa.

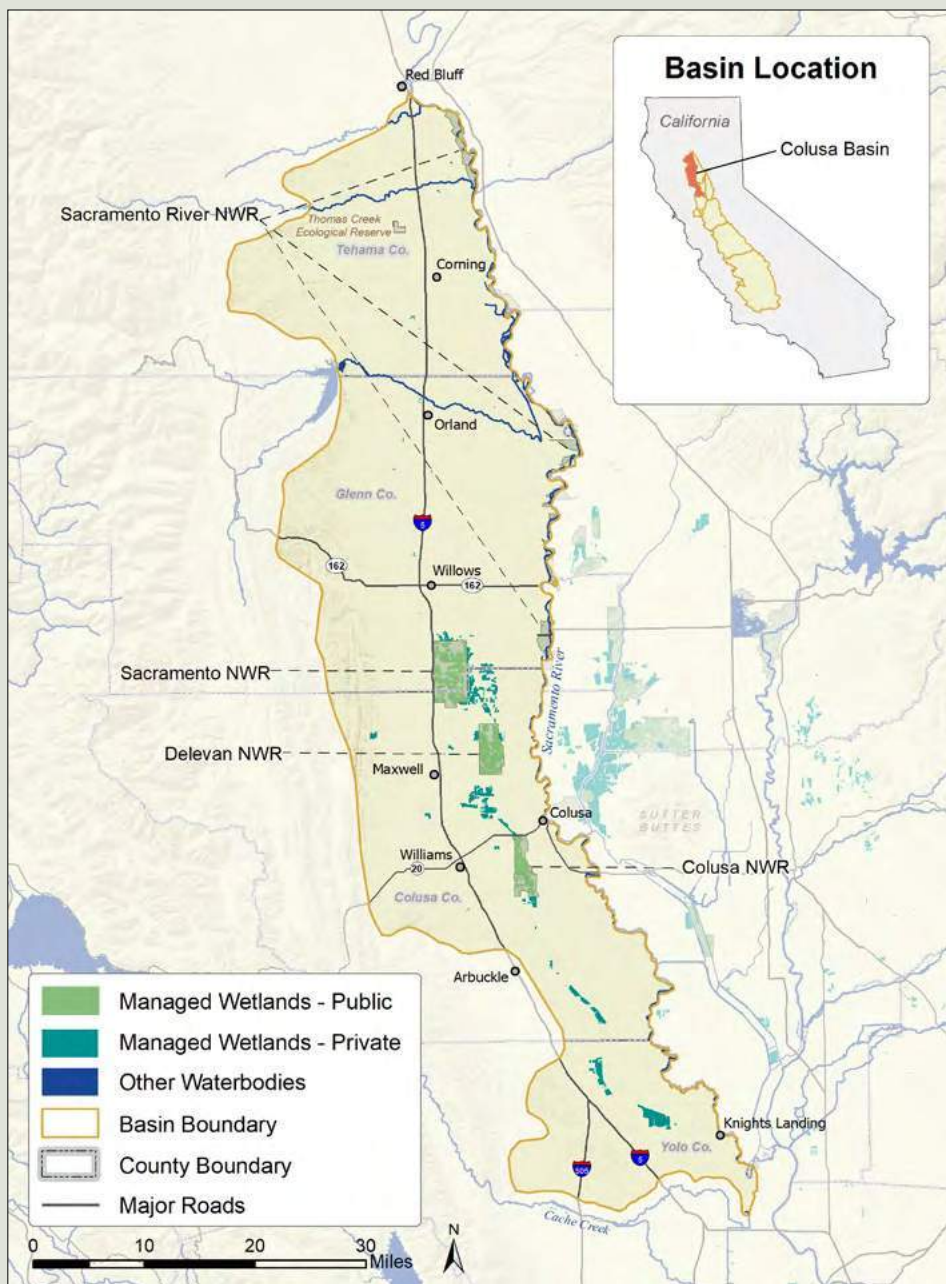

FIGURE 4.1.4 Colusa Basin.



Mixed waterfowl species, Colusa Basin - USFWS

Sutter Basin

The Sutter Basin (Figure 4.1.5) totals approximately 237,500 acres and extends south 42 miles from the Sutter Buttes to the confluence of the Feather and Sacramento Rivers. These rivers also border the basin to the east and west. Historically, overflow from the Sacramento River, Butte Sink, and Feather River flooded the Sutter Basin in winter and spring. A large portion of the basin was flooded year-round, providing significant waterfowl habitat. Although construction of the Sutter Bypass and flood control systems on the Sacramento and Feather Rivers have eliminated most of this overflow, portions of the bypass continue to provide wetland habitat. Today, most of the basin is prime agricultural and grazing land, with rice and walnuts being the predominant crops.

Many private waterfowl hunting clubs in the Sutter Basin are located within the levees of the Sutter Bypass. Protected natural areas in the basin include the Feather River WA, Sutter Bypass WA, and the Sutter NWR.

Cities and towns include Live Oak, Yuba City, and the southern portion of Gridley.

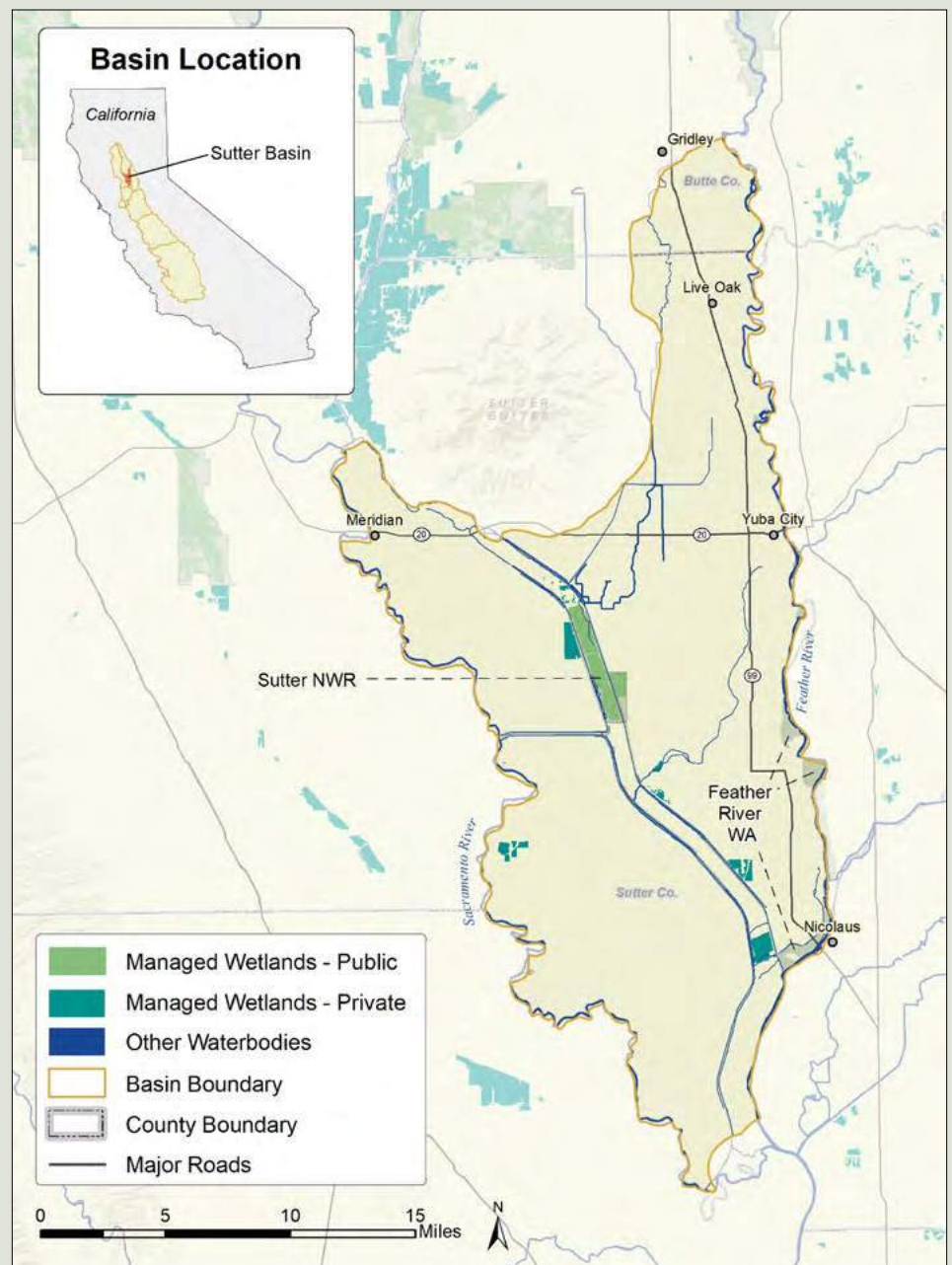

FIGURE 4.1.5 Sutter Basin.



Sutter Bypass - Daniel Nylen/American Rivers

American Basin

The American Basin (Figure 4.1.6) lies east of the Sacramento and Feather Rivers and west of the Sierra Nevada foothills. It is about 65 miles long from Oroville in the north to the American River in the south, totaling approximately 519,500 acres. Historically, water from the American, Yuba, Feather, Sacramento, and Bear Rivers flooded this area, but construction of flood control reservoirs, levees, and dams have eliminated most of this over-bank flooding.

The predominant agricultural crops in the northern portion of the basin include walnuts and rice, with rice and livestock in the southern portion.

The basin includes Reclamation District 10 and Honcut Creek areas, which constitute a large block of privately-owned wetlands in the northern portion of the basin. District 10 is a rice farming area; most of the private waterfowl clubs consist of lands that are flooded, harvested rice fields. Development pressure, high land values, and the lack of publicly protected lands have resulted in limited habitat conservation opportunities in the southern portion of the basin. Loss of rice lands to urban development has been extensive in this basin.

Cities and towns include the southern portion of Oroville, Marysville, Wheatland, Lincoln, Rocklin, Roseville, Citrus Heights, and northern portions of Sacramento.

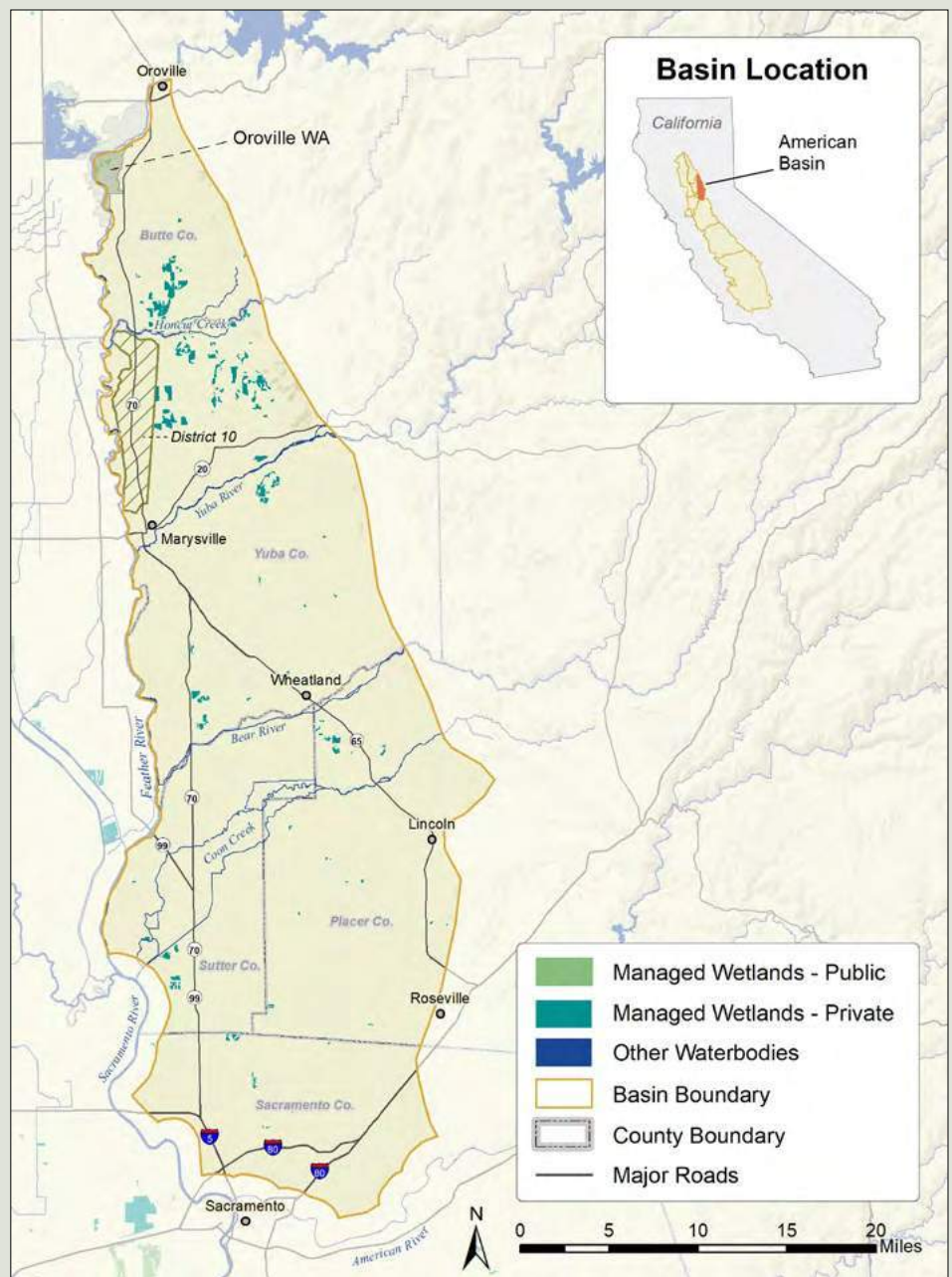
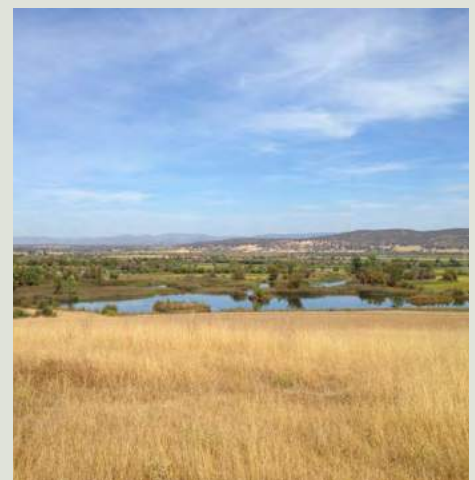

FIGURE 4.1.6 American Basin.



High Ridge Ranch Conservation Area: Wetland and rice fields permanently protected through CVJV- Jake Messerli/California Waterfowl Association

Yolo Basin

The Yolo Basin (Figure 4.1.7) lies west of the Sacramento River and is approximately 50 miles long from Cache Creek to the north to the Montezuma Hills and the Delta Basin to the south. It totals approximately 508,000 acres.

Historically, the Yolo Basin received overflow water from the Sacramento and American Rivers and the Cache, Putah, and Ulatis Creeks. Low-lying areas near the Sacramento-San Joaquin River Delta were tidally influenced and supported permanent marshes, while flooding at higher elevations produced seasonal wetland habitat.

Like much of the Central Valley, the hydrology of the Yolo Basin has been modified by levees and flood control structures. The Yolo Bypass was developed along the east side of the basin to provide flood protection for adjacent lands when flows in the Sacramento River are high. Land use in this area primarily consists of rice, pasture-land for cattle grazing, a limited amount of field crops, and freshwater wetlands and grasslands for private waterfowl clubs. Agricultural use in the western portion of the basin primarily consists of row crops, rice, and increasing acreages of nut tree crops. The southern portion of the basin has windmills for power generation.

Most of the state-owned Yolo Bypass WA is located in the Yolo Basin, as is the Fremont Weir WA. Other protected areas include Russell Ranch (University of California) and Jepson Prairie Preserve and Wilcox Ranch (Solano Land Trust).

Cities and towns include West Sacramento, Woodland, Davis, Winters, Dixon, Vacaville, and Rio Vista.

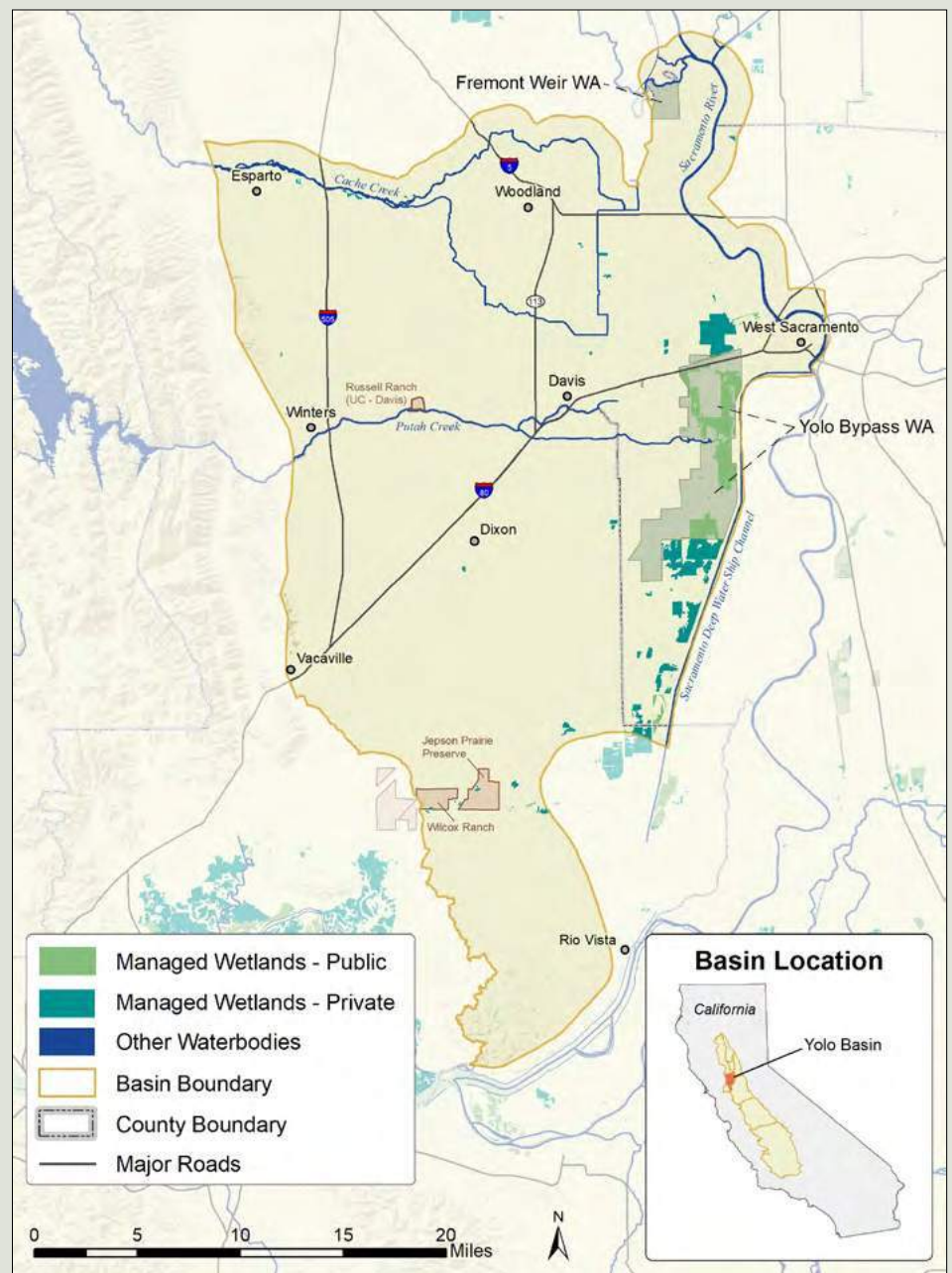

FIGURE 4.1.7 Yolo Basin.



Fremont weir and adjacent agriculture - Daniel Nylen/American Rivers

Suisun Basin

Suisun Basin (Figure 4.1.8) is approximately 20 miles long from the southern end of Vacaville on the north to the Contra Costa County line on the south. It totals about 152,000 acres and is adjacent to the San Francisco Joint Venture eastern boundary. The Carquinez Strait and Coast Range border this basin on the west, the Sacramento-San Joaquin Delta on the east. The basin is dominated by Suisun Marsh, the largest contiguous estuarine marsh in the United States. The marsh is brackish and lies between the freshwater wetlands of the interior Central Valley and the saltwater marshes of the San Francisco Bay and coast, encompassing approximately 88,000 acres of wetlands, bays and sloughs in southern Solano County. The 115,000-acre Suisun Resource Conservation District (SRCD), established in 1963 as a Special District of the State of California, includes 52,000 acres of publicly and privately managed wetlands, 6,000 acres of unmanaged tidal wetlands, 30,000 acres of bays and sloughs, and 27,000 acres of upland grasslands. There is a long tradition of waterfowl hunting in Suisun Marsh (since the 1890s), and the conservation of the marsh's managed wetland habitats is key to maintaining hunter heritage. Agriculture does not have a significant presence in the marsh, but the upland grasslands and rangeland in the eastern Suisun Basin support livestock grazing.

Historically, Suisun Marsh was tidally influenced with large portions of the marsh submerged regularly (Moyle et al. 2014). Levee construction in the 1850s restricted tidal flows for agricultural and waterfowl hunting purposes. Tide gates and levees currently protect the managed wetlands from tidal flooding; however, salinities have gradually increased because of freshwater diversions upstream of the marsh from the San Joaquin and Sacramento Rivers. Costs to maintain managed wetland habitat in the Suisun Basin are higher than in

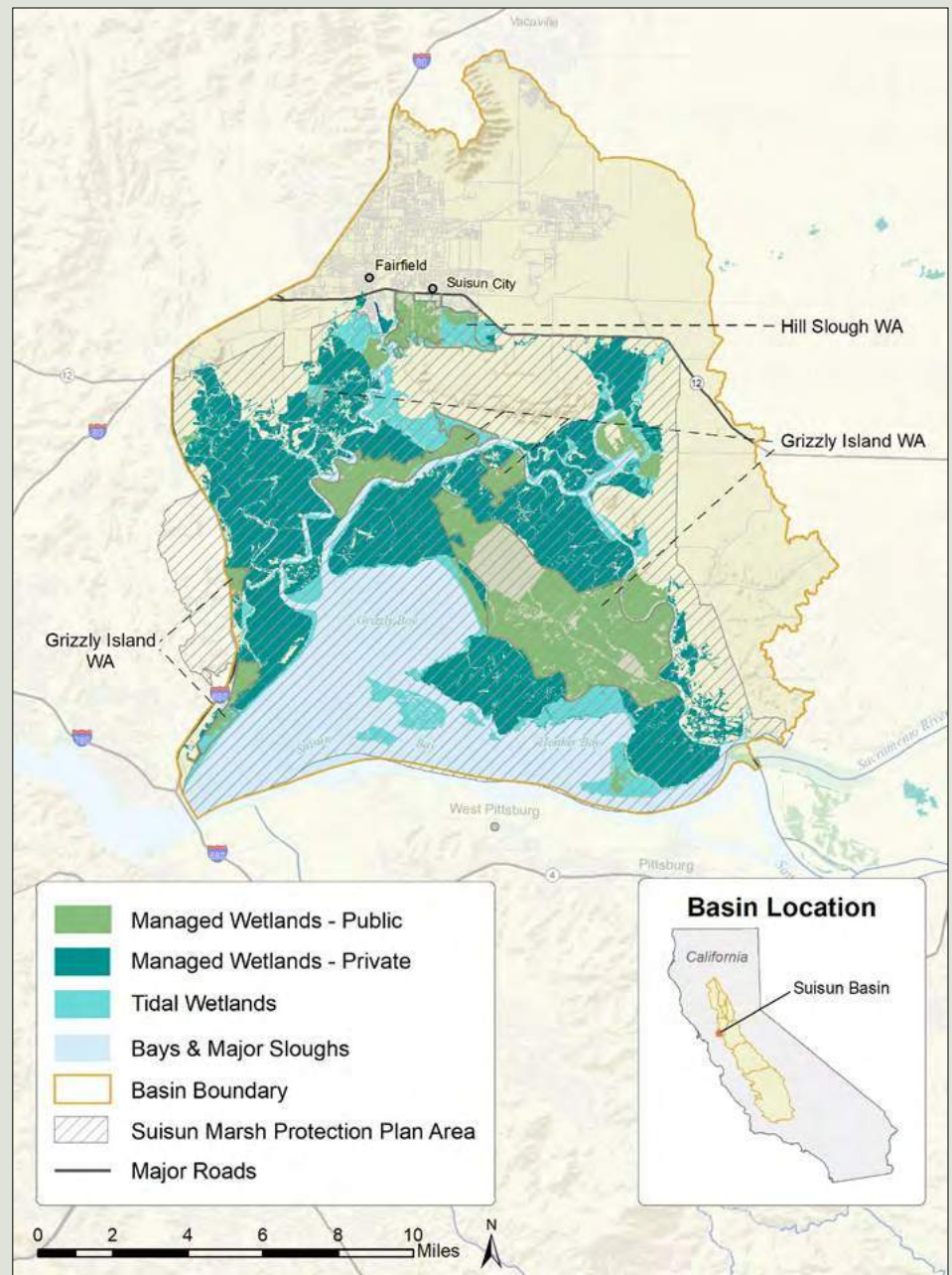

FIGURE 4.1.8 Suisun Basin.

other parts of the Central Valley, due to the cost of exterior levee maintenance and the effects of the corrosive brackish environment on infrastructure. Suisun Marsh has a dependable water supply even in drought years, providing reliable habitat for resident and early migrating waterfowl and stable hunting opportunities. Suisun Marsh is also an important breeding area and supports one of the highest densities of nesting ducks in North America (McLandsress et al. 1996).

The Suisun Marsh Preservation Act of 1974 (California Public Resources Code 29000-29612) and the resulting Suisun Marsh Protection Plan (1976) protect the marsh from development to preserve its integrity. The Suisun Basin also has state-managed public lands, including the Grizzly Island WA, the Hill Slough WA, and the Peytonia Slough Ecological Reserve.

Cities and towns include Fairfield, Suisun City, and the southern portion of Vacaville.

Delta Basin

The Delta Basin (Figure 4.1.9) totals approximately 1,687,000 acres and extends 75 miles from the American River in the north to the Stanislaus River in the south. The Sierra Nevada foothills border the basin to the east, the Sacramento River to the northwest, and the Coast Range to the southwest.

Prior to the mid-1800s, the Delta Basin was part of a larger estuary that included Suisun Marsh and San Francisco Bay. Development of the basin began in the 1850s, when the Swamp Land Act transferred ownership of all “swamp and overflow land” from the federal government to the state. By the early 1900s, nearly all the Delta’s wetlands had been converted to agriculture.

The convergence of the Sacramento, San Joaquin, Cosumnes, Mokelumne, and Calaveras Rivers forms this basin. The Lower Sherman Island WA riparian marshlands sit at this confluence. Numerous other creeks and rivers also contribute to this Delta matrix. This confluence is subject to tidal movement and water diversions as it flows into the San Francisco Bay. A 1,000-mile network of levees has reclaimed 60 former wetland islands in the Delta. These islands are intensively leveed and farmed, and land subsidence, potential levee failure, and saline water intrusion are threats to many of these properties. Some are managed as waterfowl hunting clubs after crop harvest, with corn a major contributor to habitat values for waterbirds in the basin. Land conversion in the southern part of the Delta Basin, from pasture to permanent crops, has resulted in lost habitat for grassland birds and the loss of late winter/early spring foraging habitat for geese. Predominant crops include wine grapes, fruit trees and grains. The dairy industry follows grape production as the second highest grossing commodity.

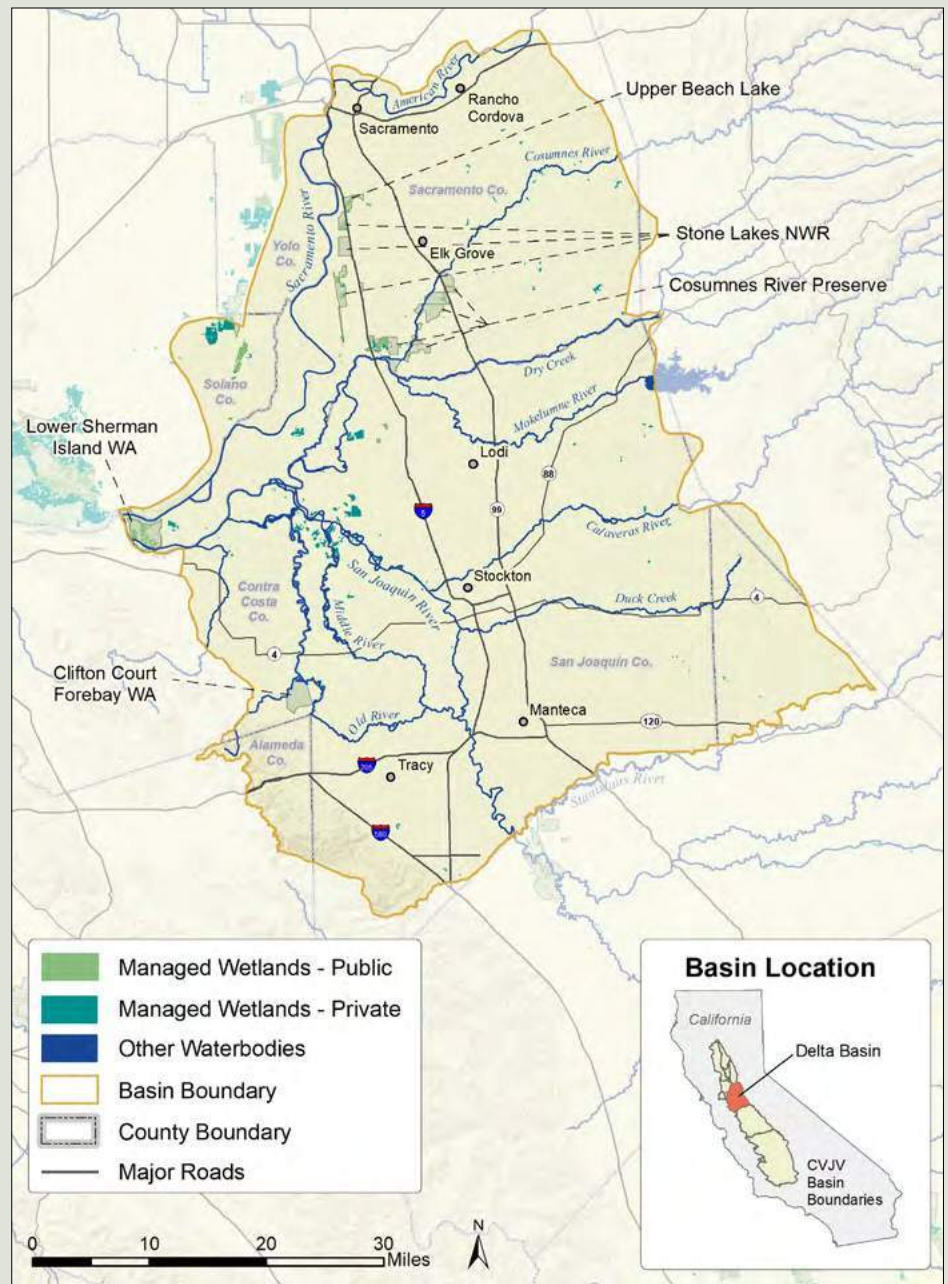
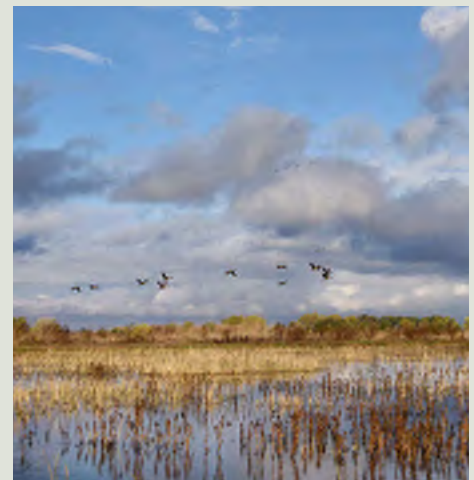

FIGURE 4.1.9 Delta Basin.

Protected areas in the basin include the jointly-owned (state, federal, county, and non-governmental organization) Cosumnes River Preserve; the state-owned Lower Sherman Island WA and Clifton Court Forebay; Upper Beach Lake (Sacramento County); and Stone Lakes NWR.

Cities and towns include Rancho Cordova, Sacramento, Elk Grove, Lodi, Stockton, Manteca, and Tracy.



Cosumnes River Preserve - BLM

San Joaquin Basin

The San Joaquin Basin (Figure 4.1.10) totals approximately 2,845,000 acres, extending 80 miles from the Stanislaus River in the north to the San Joaquin River in the south. The Coast Range borders the basin on the west, the foothills of the Sierra Nevada on the east. Where it turns north, the San Joaquin River bisects the basin from north to south, with major tributaries including the Chowchilla, Merced, Fresno and Tuolumne Rivers.

The basin contains several federal and state wildlife refuges as well as extensive private wetlands located in the Grassland Resource Conservation District (GRCD) on the western side of the basin. Many of these private wetlands are permanently protected by state and federal conservation easements, and most wetlands in this area have reliable water supplies. The hunting culture in the basin has deep roots in the community, contributing substantially to the local economy during waterfowl season.

Soils on the western side of the San Joaquin Basin are derived from marine sediments that are high in salts and trace elements. Postharvest irrigation was formerly used to leach these substances from the upper soil, and return flows were used as a wetland water source. Selenium concentrations in this tailwater proved damaging to a wide range of birds. In this regard, it is important to consider the long-term future of the San Luis Drain. The drain once carried contaminated subsurface agricultural drainage water into adjacent wetlands. Although used less frequently today, the drain still serves as an important “bypass” of the wetlands, discharging drainage water and storm water into Mud Slough (north) and the San Joaquin River.

Public and private wetlands rely on a relatively small amount of well water. These wetlands are currently undergoing a planning process to comply with the Sustainable Groundwater Management Act of 2014.

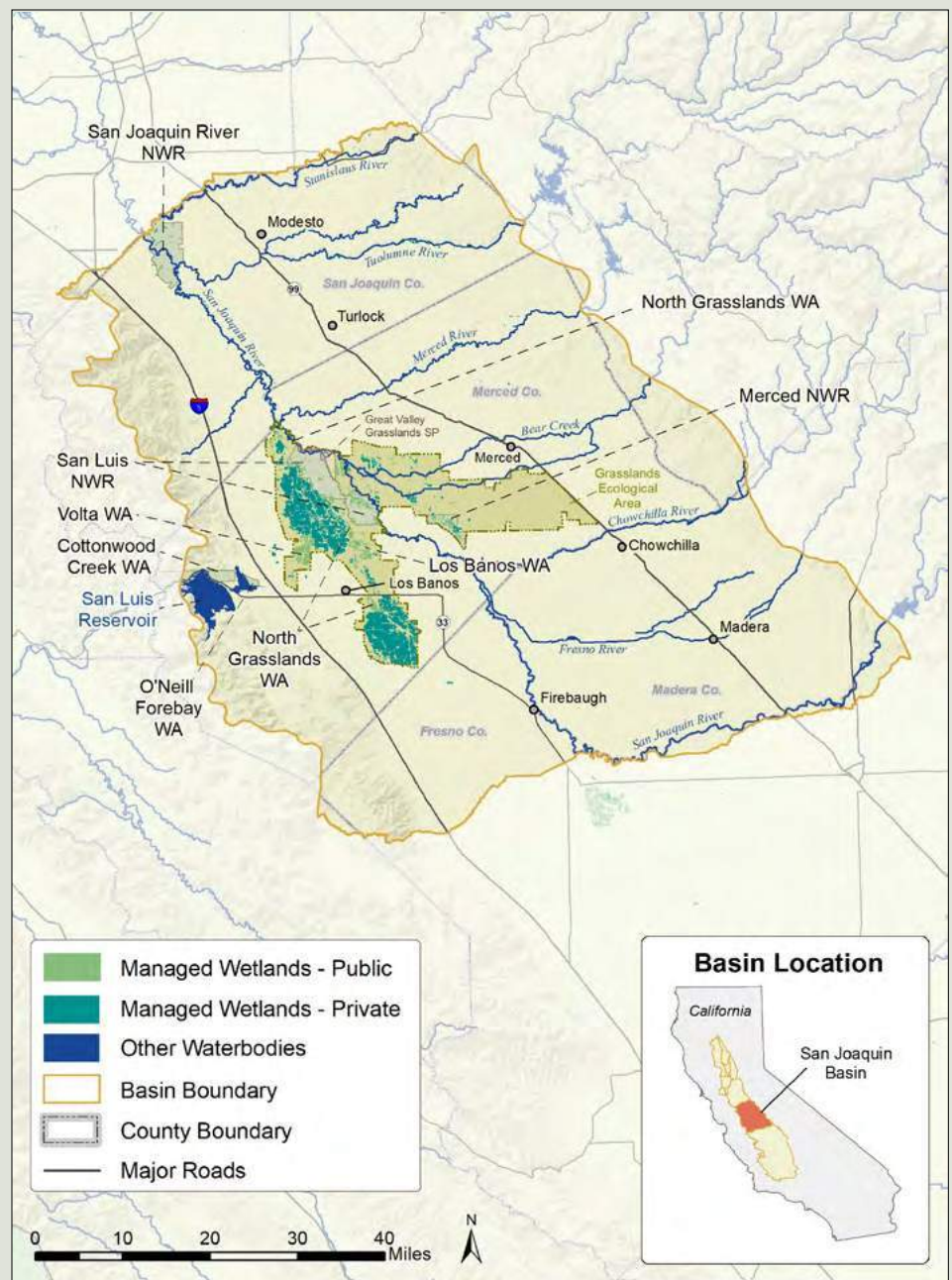

FIGURE 4.1.10 San Joaquin Basin.

Wildlife-friendly agricultural crops are limited in the San Joaquin Basin, even though agricultural production is a primary land use.

Protected areas include federally-owned San Joaquin River NWR, San Luis NWR Complex; state-owned Los Banos WA, Volta WA, North Grasslands WA, and Cottonwood Creek WA; Great Valley Grasslands State Park; and the federal and state jointly-owned San Luis Reservoir and O'Neil Forebay WA. The 2017-approved expansion of San Joaquin

River NWR includes 11,000 acres of river corridor that could join the current refuge area with the GEA and riparian corridors.

Cities and towns include Modesto, Turlock, Merced, Los Banos, Chowchilla, and Madera.

Tulare Basin

The Tulare Basin (Figure 4.1.11) is the largest basin in the Central Valley, totaling approximately 6,655,000 acres bordered by the Coast Range to the west and the southern Sierra Nevada foothills to the east. This basin is 150 miles long, extending from the San Joaquin River on the north to the Sierra Madre Mountains, the Cuyuma Valley, and the Tehachapi Mountains on the south. The basin includes the Carrizo Plain at its southwestern end, a large enclosed grassland plain approximately 40 miles long and 20 miles across, located in southeastern San Luis Obispo County. It is the largest native grassland remaining in California.

Despite being the driest region of the Central Valley, the Tulare Basin once contained the largest single block of freshwater wetland habitat in the United States west of the Great Lakes (Garone 2011), and it provided over 500,000 acres of permanent and seasonal wetlands. During most years, the basin functioned as a sink, where water from the Sierra Nevada flowed down a number of waterways, including the Kern, Kings, and Tule Rivers, into a series of shallow lake basins. During exceptionally wet years, water flowed north from these lakes into the San Joaquin River. Diversion of water for agricultural and municipal purposes ultimately drained the Tulare Basin lakebeds and allowed these wetlands to be reclaimed for agriculture. These lakebeds now remain dry in all but the wettest years, and the amount of wetland habitat remaining in the Tulare Basin is less than one percent of historical levels. Surface water in the basin is limited, and reduced flows in water channels contribute to native tree mortality in riparian areas and severely reduce the ability of private wetlands to access this water.

Historically, the Tulare Basin had over 200 private waterfowl hunting clubs. Today, only a fraction of those clubs remains. Some of the habitat is protected under federal conservation easements, but most are unprotected, and most rely on groundwater with high pumping costs. The wetlands in the Tulare Basin receive

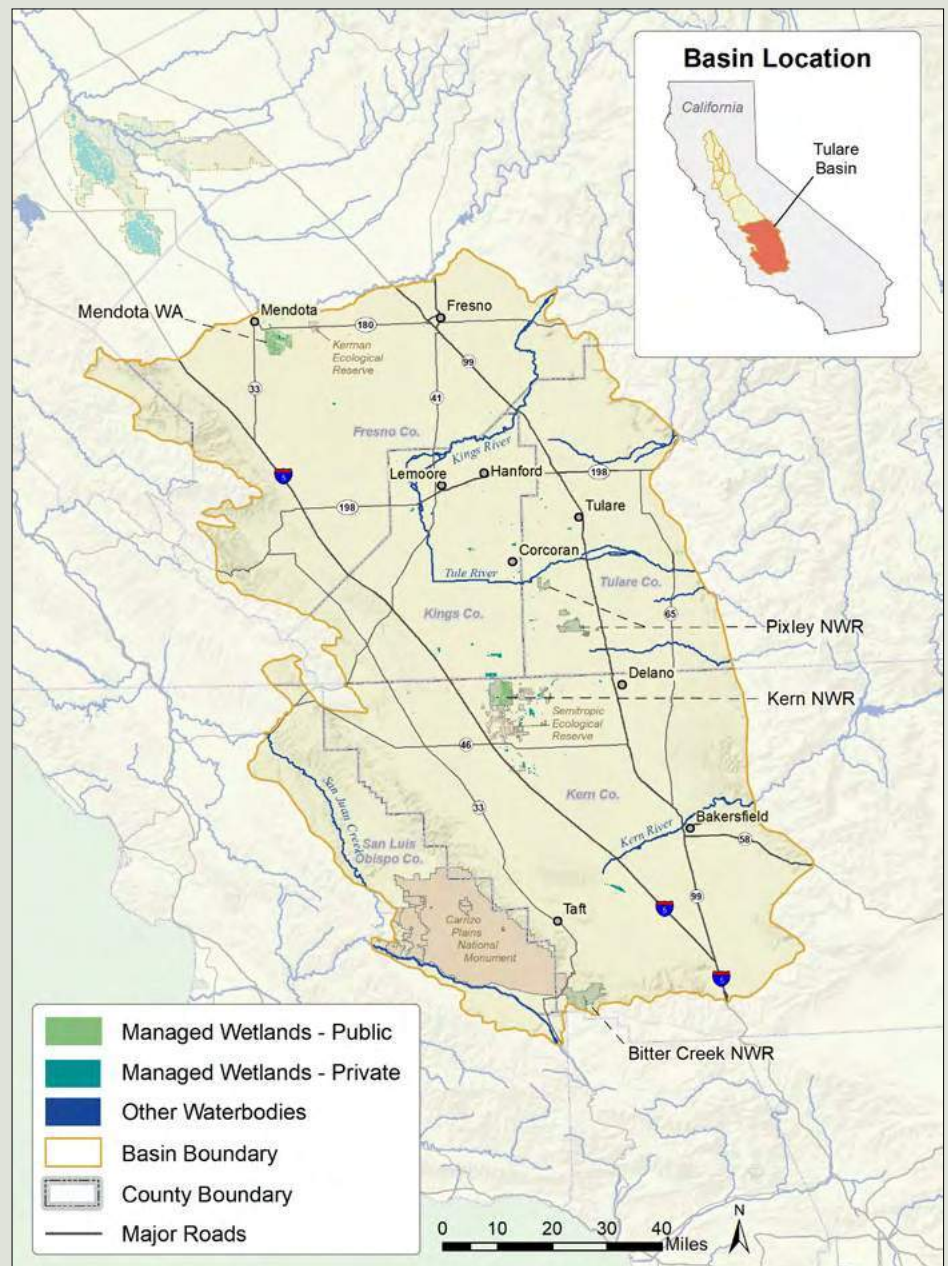

FIGURE 4.1.11 Tulare Basin.



Sunset over grasslands in the San Joaquin Valley. - BLM

floodwaters more unpredictably than in other parts of the Valley, and although this water is periodically plentiful, private wetlands' infrastructure restricts the ability to accept and store this water.

The Sustainable Groundwater Management Act of 2014 requires that critically over-drafted groundwater basins, like the Tulare Basin, come into compliance with the law within 20 years. It is likely that groundwater users will eventually have to reduce their use to only a fraction of the amount they are currently using. Land prices are limiting acquisition of fee-title and easement lands for the purpose of habitat conservation; however, substantial agricultural acreage is projected to be fallowed due to new groundwater requirements, and this may result in increased options for upland protection and restoration opportunities in this basin.

Protected areas include federally-owned Kern NWR, Pixley NWR, and Bitter Creek NWR and Atwell Island; state-owned Mendota WA, Kerman ER, and Semitropic ER; Semitropic Ridge Preserve (Center for Natural Lands Management); and county-owned Kern County Valley Floor Habitat Conservation Plan lands.

Cities and towns include Mendota, Fresno, Visalia, Tulare, Hanford, Lemoore, and Bakersfield.

Secondary Focus Area

The CVJV's Secondary Focus Area (Figure 4.1.1) is approximately 27,400 square miles (17, 537,000 acres) bordering the Central Valley and generally following the crest of the mountain ranges that rim the Valley, descending in elevation as it approaches the Sacramento-San Joaquin River Delta and Suisun Marsh. This area is surrounded by grasslands and oak woodland habitat at lower elevations and a variety of habitats as the terrain ascends in elevation including scrublands, montane hardwood woodlands, meadows, and coniferous forest habitats. Grassland and oak savannah ecosystems are important upland components, particularly the open country low-elevation foothills and rangelands that surround the perimeter of the Valley floor (DiGaudio et al. 2017). The CVJV's bird conservation work currently concentrates in this "foothill ring."

About 60 percent of the Central Valley's historical grasslands have been lost due to urban development and conversion to intensive agriculture, such as orchards, vineyards, and row crops. Historical data on the extent of oak savannah ecosystems in the Valley are lacking, but the magnitude is probably similar. Oak woodlands face threats such as habitat loss, lack of oak regeneration, fire, over-grazing, and sudden oak death disease. Today, both ecosystems are still at risk of conversion (CPIF 2000; DGP-GIC 2003).

Annual grassland habitat occurs mostly on flat plains to gently rolling foothills and is dominated by non-native grasses. There is evidence to suggest that many of the areas dominated by non-native annual grasses may have formerly been dominated by different vegetation types such as woodlands, chaparral, or coastal scrub. Over time, the "foothill ring" area was modified to provide rangeland habitat, and today non-historical grass species constitutes the major portion of the present grassland range (Hamilton 1997). Perennial grasses are still found in moist, lightly grazed, or relic prairie areas. Lands within this area are predominantly composed of private working ranches that include a rich and varied landscape of grasslands, oak savannah and woodlands, vernal pools, riparian areas, and wetlands. The state's large rangeland areas provide continuous open space critical for wildlife movement and ecological function (Spencer et al. 2010), yet rangelands are among the least protected habitats in the state.

The Secondary Focus Area includes protected lands such as the state-owned Tehama WA and federally-owned Folsom Lake and Auburn State Recreation Areas. Portions of Lassen, Mendocino, Plumas, Eldorado, Stanislaus, Sierra, Sequoia, Los Padres National Forests, and the Yosemite and Kings Canyon National Parks are also in this area.

Major cities and towns include Clearlake, Red Bluff, Paradise, Grass Valley, Nevada City, Auburn, Ione, Placerville, Sonora, and Tehachapi.

4.2 WATER

Adequate water supplies are critical for wetland-dependent bird habitat, which includes both managed wetlands (such as refuges) and flooded agricultural lands. Water creates the well-recognized flooded ponds and moist, marshy soils that characterize wetlands everywhere. Maintaining healthy and productive wetlands requires adequate and reliable access to water. In the Central Valley (“the Valley”), wetland-dependent bird habitat is almost entirely “managed,” either as semi-permanent or seasonal wetlands, or on flooded agricultural lands that provide a wetland habitat function. These wetland habitats are distributed across state and federal refuges, privately-owned conservation easement lands, other private property (such as duck clubs), and agricultural land, particularly rice.

The prevalence of each wetland habitat type is important to ensure that adequate habitat – as well as recreation, education, and other services – is provided every year by wetlands collectively, regardless of precipitation, regulatory and political environment, funding availability, commodity prices and land use decisions, and other factors. Each type of wetland habitat has different water needs, both in amount and timing of applied water.

WHY DO WETLANDS NEED WATER?

In the spring, water provides nesting and foraging habitat for breeding waterbirds (including waterfowl, shorebirds and other water-dependent bird species), germinates seeds, and irrigates perennial plants on managed wetlands that will later provide food and shelter for birds. Summer water nurtures these plants and improves the productivity of wetland soils, provides foraging for young birds, and creates mudflat conditions important for migrating shorebirds. In the fall and winter, water is used to flood managed wetlands and some agricultural land, such as rice and corn after harvest, making waste grain and invertebrates available as food to waterfowl and shorebirds, as well as providing places to rest.

After creating these important environmental benefits, as well as numerous recreational, educational and economic benefits, most wetland water either percolates through the soil to recharge local groundwater basins or returns to rivers and streams with nutrients to enhance the aquatic food web or supplying water for other uses downstream.

Ensuring reliable and affordable water supplies for wetland habitat management may be the Central Valley Joint Venture’s (CVJV) greatest challenge. Since publication of the 1990 Central Valley Habitat Joint Venture Implementation Plan (CVJV 1990), overall demand for water in the Valley has increased at an alarming rate. At the same time, complicated factors have led to reduced water supplies for many wetlands. These factors include in-stream dedication for threatened and endangered fish species, human population growth, and changing agricultural practices. The economic and political competition for water has intensified, and the cost of water in some basins has risen tenfold. In addition, climate trends are leading some wetland water supply managers to change how they plan for resiliency.

The CVJV plays several significant roles in ensuring the reliability and sustainability of wetland water supplies. These roles include communicating the extent to which bird habitat is fundamentally linked to water availability; understanding the implications of constantly changing factors related to wetland water supply; advising agencies involved in implementing significant legislation; and facilitating and encouraging advocacy, creative thinking, and on-the-ground solutions.

This subchapter first provides important historical and political context for understanding the water supply needs and challenges faced by the Valley wetlands today. Next, it explains the water needs of different wetland types and

describes the water supplies that are needed to meet those needs. Water needs are extrapolated to estimate the water necessary to meet the waterfowl and shorebird population targets and the associated habitat objectives determined for this Implementation Plan. Finally, the constraints and opportunities around acquiring, delivering, and managing water to meet wetland habitat needs are explained.

History of Central Valley Wetland Water Supplies

The extent of habitat for wetland-dependent bird species in the Central Valley has changed extraordinarily over the last 150 years. The amount of water available to create wetlands and the way wetlands receive that water have also changed. Inundation and flooding in the Central Valley in the winter and spring, caused by confining rivers within artificial levee systems, requires flooding and irrigations to be managed through human-made structures to divert or pump water from rivers, ditches and groundwater wells. The very existence of most wetlands now relies on conveyance and delivery systems. Understanding this context and how much water wetlands need is critical to their sustainability and protection.

Wetland water before development

Prior to the Gold Rush of the mid-1800s, the Valley contained more than four million acres of dynamic wetland complexes that included and were bordered by flooded riparian and grassland habitats (Frayer et al. 1989). Many wetlands were seasonal in nature and resulted from over-bank flooding of rivers and streams that inundated large areas of the Valley during winter and spring. The timing and duration of these waters also supported the productivity of moist soils and germination of beneficial food plants for the following year as well as supporting riparian vegetation. Slowly receding water provided habitat for a variety of bird species throughout the summer and fall months until rains returned in the late fall and winter, when the cycle began again.

Wetland water from development through 1992

In less than a century, large-scale gold extraction techniques, flood control projects, and land reclamation projects for agriculture and urban development led to the conversion of over 90 percent of the Valley wetlands to other uses. Human settlement increased the need to control annual flooding of the major river systems to protect developing cities, homesteads and associated infrastructure. As flood control levees were built to tame the rivers, agricultural lands expanded, and dams were constructed to provide additional flood con-

trol and water storage for expanding urban, industrial and agricultural needs.

As the population of California increased, so did the demand for agricultural products and other services. The Central Valley Project (CVP), a federal water project, was initially authorized in 1935 as a long-term plan to control floods and develop and manage water for industrial, municipal and agricultural uses. The CVP and California's companion State Water Project (SWP) constructed major dams and conveyances to store water during wet years, release water when needed by agriculture during the dry summer months, and convey water to farms and cities throughout the Valley. The CVP is capable of storing over 11 million acre-ft of water and transporting it through 500 miles of canals. By the 1950s, expanding agricultural development and water projects that redirected water historically available to wetland areas had decreased Valley wetlands to an estimated 290,000 acres (CVJV 1990).

Resident and migratory bird populations were severely impacted during this time (Frayer et al. 1989). The first wildlife refuges were established in the early 1930s. As the extent of natural wetlands continued to decline into the 1970s, more public and private lands were set aside to be managed as wetlands. Water supplies for managed wetlands during this period were not secure. Most managed wetlands depended upon agricultural irrigation return flows, low-priority water contracts, or non-binding agreements with water districts. Some of those historical agreements continue to this day¹. With few exceptions, these contracts and agreements provided water supplies on an "if and when available basis," with supplies being severely reduced, or eliminated, during drought years.

Severe drought during the latter part of the 1970s greatly reduced wetland water supplies and, in some instances, eliminated all water deliveries to remaining wetlands in the Valley. The combination of drought and poor water supply reliability resulted in significant negative impacts to wetland habitat

1. Examples include wetlands in the Butte Sink area that receive fall and winter water via a 1922 agreement with Western Canal Company and Pacific Gas & Electric Company; the Sacramento, Delevan, and Colusa National Wildlife Refuges, which receive water through agreements with Glenn-Colusa Irrigation District; and the Gray Lodge Wildlife Area, which receives a portion of its water needs from the Biggs-West Gridley Water District for lands allocated "Class 1" Feather River settlement water. Another example involves the Grassland Mutual Water Association, which filed suit against the U.S. Department of the Interior after losing San Joaquin River supplies when the Friant Dam Project began diverting flows from the San Joaquin River for agriculture and municipal and industrial uses in the Tulare Basin. A settlement provided 50,000 acre-ft of water (if and when available) for wetlands within the Grassland Water District during the fall and winter months. The California Department of Fish and Wildlife also negotiated agreements with the U.S. Bureau of Reclamation and various local water districts for many of its wildlife areas.

and to waterbird populations, and especially to non-breeding waterfowl.

By the end of the 1970s, political pressure from concerned landowners and wildlife agencies led to investigations and peer-reviewed publications that made the case for more reliable supplies of water for remaining Valley wetlands. These studies, along with passage of the National Environmental Policy Act and State and Federal Endangered Species Acts, set the stage and provided a critical basis for environmental protections for the Valley wetlands. These protections were codified in new legislation, which was under development as the U.S. Bureau of Reclamation (USBR) renewed water supply contracts with its CVP customers.

As these investigations progressed, other actions were underway that would significantly affect the Valley's wetlands. The North American Waterfowl Management Plan, an international treaty between the United States and Canada, was signed in 1986 and identified the Central Valley as one of the six priority habitat areas for North American waterfowl. The CVJV was subsequently formed in 1988. Recognizing the importance of sufficient, reliable water supplies for waterfowl health, as demonstrated by many scientific studies, one of the objectives stated in the CVJV 1990 Implementation Plan was to secure reliable water supplies for publicly-owned Central Valley wetlands, the privately managed wetlands within the Grassland Resource Conservation District (GRCD), and elsewhere in the Valley. (For more details, see text box: "The science-based need for reliable wetland water supplies.")

CVPIA mandates wetland water

The Central Valley Project Improvement Act (CVPIA), Title 34 of Public Law 103-575, was passed in 1992. This Act amended previous authorizations of the CVP to include fish and wildlife protection, restoration, and mitigation as project purposes having equal priority with irrigation and domestic uses, and fish and wildlife enhancement as a project purpose equal to power generation.

WATER SUPPLY TERMS

L2 – Level 2 refuge water supply: The minimum amount of water necessary to maintain wetlands and wildlife habitat benefits based upon average water deliveries occurring prior to 1992. This amount totals 422,251 acre-ft per year.

IL4 – Incremental Level 4 refuge water supply: The additional quantity of water, above L2, that each habitat area needs to reach Full L4.

Full L4 - Full Level 4 refuge water supply: The total amount required by CVPIA for optimal habitat management. Some habitat areas will need investments to improve or develop infrastructure necessary to receive Full L4 supplies.



Flooded wetlands, Grasslands Ecological Area - USFWS

THE SCIENCE-BASED NEED FOR RELIABLE WETLAND WATER SUPPLIES

Severely declining populations of resident and migratory birds in the 1970s and 1980s led to a number of studies on Central Valley wetland water needs. One of the first studies published during this period was the Total Water Management Study for the Central Valley Basin of California (USBR, unpublished report, 1978, see "Notes"). This study included Working Document No. 12, "Fish and Wildlife Problems, Opportunities, and Solutions" (USBR, unpublished report, 1978, see "Notes"), a survey of major fish and wildlife problems and improvement opportunities within the geographical area encompassed by the CVP. As a result of the study's findings, the USBR initiated the Central Valley Fish and Wildlife Management Study of 1979 (USBR, unpublished report, 1979, see "Notes"). The study established a comprehensive baseline of Central Valley fish and wildlife resources and recommended specific solutions to water related issues.

These studies continued into the early 1980s and resulted in a report, *Refuge Water Supply, Central Valley Hydrologic Basin, California 1986* (USBR 1986) that addressed waterfowl and wetland habitat. This study served as the basis for the 1989 *Report on Refuge Water Supply Investigations, Central Valley Hydrologic Basin, California* (USBR 1989), estimated average historical managed wetland water supplies ("Level 2" water supplies) and developed ecologically sound estimates of wetland water needs for optimal habitat management ("Level 4" water supplies). This report provided a critical basis for codified environmental protections that were under development and required adequate water supplies to support the 19 refuges that became part of the environmental baseline requirements as USBR renewed water supply contracts with its CVP customers.

Following passage of the Central Valley Project Improvement Act (CVPIA), many CVP water users were concerned about how the refuge water supply provisions would be implemented. To address those concerns, best management practices and efficient use plans were developed for the managed wetlands covered by CVPIA. In 1996, Deputy Secretary of the Interior John Garamendi directed that an Interagency Coordinated Program Task

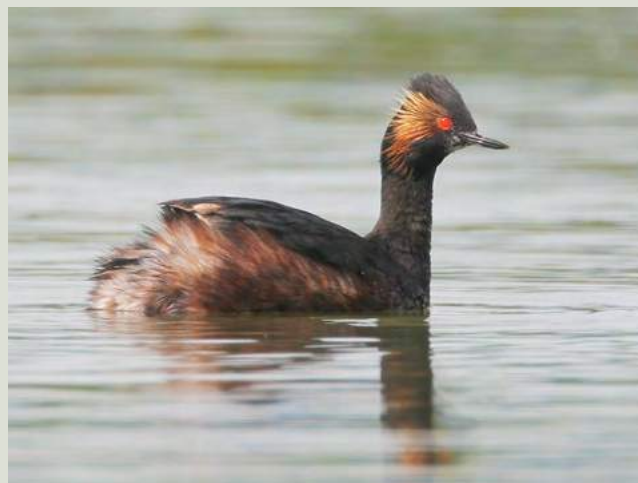

Eared grebe - Tom Grey

Force be instituted to provide a common methodology for water use planning and efficient water regimes for all wetland areas receiving water authorized by CVPIA. Their final report, *An Interagency Coordinated Program for Wetland Water Use Planning: Central Valley, California* (USBR et al. 1998), estimated monthly and annual water supplies needed to properly manage state, federal and GRCD seasonal and semi-permanent wetlands for each basin.

CVPIA Section 3406 (d)(6)(A,B) required the investigation of water and conveyance needs for private wetlands not covered by the other provisions of the Act. The 2000 *Central Valley Wetlands Water Supply Investigations, CVPIA 3406 (d)(6)(A,B), A Report to Congress* (USFWS 2000) was produced as a result. Central Valley water suppliers were interviewed and their comments incorporated into the Water Report. Most expressed concern over the long-term shortages of water supplies resulting from a statewide lack of new water development (e.g., groundwater banking, new reservoirs, and new conveyance infrastructure); a reduction of Colorado River water supplies; and increasing urban and environmental demands that reduce supplies for agricultural and other uses. Although most suppliers face no legal obstructions to providing wetland water, many believed that agriculture would have priority if water shortages develop.

Collectively, these studies provided a scientific and peer-reviewed basis for wetland water needs estimates in CVPIA and water contracts, and many of these publications are still referenced today by wetland and water managers throughout California and the West.

REFUGE NAME	LEVEL 2 (ACRE-FT)	INCREMENTAL LEVEL 4 (ACRE-FT)	FULL LEVEL 4 (ACRE-FT)
Colusa Basin			
Sacramento National Wildlife Refuge ^a	46,400	3,600	50,000
Delevan National Wildlife Refuge ^a	20,950	9,050	30,000
Colusa National Wildlife Refuge ^a	25,000	0	25,000
Subtotal	92,350	12,650	105,000
Sutter Basin			
Sutter National Wildlife Refuge ^a	23,500	6,500	30,000
Subtotal	23,500	6,500	30,000
Butte Basin			
Gray Lodge Wildlife Area	35,400	8,600	44,000
Subtotal	35,400	8,600	44,000
San Joaquin Basin			
San Luis Unit ^b	19,000	0	19,000
West Bear Creek Unit ^b	7,207	3,603	10,810
East Bear Creek Unit ^b	8,863	4,432	13,295
Kesterson Unit ^b	10,000	0	10,000
Freitas Unit ^b	5,290	0	5,290
Merced National Wildlife Refuge	13,500	2,500	16,000
Los Banos Wildlife Area	16,670	8,330	25,000
China Island Unit ^c	6,967	3,483	10,450
Salt Slough Unit ^c	6,680	3,340	10,020
Volta Wildlife Area	13,000	3,000	16,000
Grassland Resource Conservation District	125,000	55,000	180,000
Subtotal	232,177	83,688	315,865
Tulare Basin			
Mendota Wildlife Area	27,594	2,056	29,650
Kern National Wildlife Refuge ^d	9,950	15,050	25,000
Pixley National Wildlife Refuge ^d	1,280	4,720	6,000
Subtotal	38,824	21,826	60,650
Contract Total	422,251	133,264	555,515

Source: CVPIA Refuge Water Supply Program

^a Part of the Sacramento National Wildlife Refuge Complex

^b Part of the San Luis National Wildlife Refuge Complex

^c Part of the North Grasslands Wildlife Area

^d Part of the Kern National Wildlife Refuge Complex

TABLE 4.2.1 Water deliveries to refuges required by the CVPIA.

Due in part to an investment in the legislative process by CVJV partners, provisions were made in CVPIA Section 3406 (d)(1-5) to meet wetland water needs. The law authorized water supplies for those wetland areas covered by the 1989 Report and the San Joaquin Basin Action Plan/Kesterson Mitigation Action Plan, a plan developed to mitigate the habitat losses resulting from the Kesterson National Wildlife Refuge (NWR) selenium contamination of the 1980s, and to implement the objectives of the CVJV. The CVPIA mandated delivery of historical water supplies, referred to as “Level 2” supplies, and two-thirds of the full water supply requirements for lands identified in the Action Plan from the CVP. In addition, “Incremental Level 4” water supplies were to be acquired through purchase from willing sellers and provided in increasing 10 percent increments per year until 2002, when full water supply requirements were authorized. Table 4.2.1 lists the water deliveries mandated by the CVPIA.

In addition to requiring water delivery, Section 3407(d) established the CVP Restoration Fund as a critical funding source for CVPIA activities. The Restoration Fund contributes about \$50 million annually to support salmon restoration activities and water delivery to 19 critical state and federal wildlife refuges and private wetlands within GRCD in the Central Valley. Water from the CVP and hydropower users make annual payments into the Restoration Fund, and the USBR administers the program.

Several long-term water conveyance/supply contracts and agreements were negotiated during the 1990s that increased the reliability of CVPIA water supply delivery. These contracts and agreements called for the establishment of an Interagency Refuge Water Management Team (IRWMT). Comprised of USBR, USFWS, CDFW,

CVPIA: LANDMARK LEGISLATION FOR CENTRAL VALLEY WETLAND RECOVERY

To date, the CVPIA is one of the most important legislative actions taken to protect and restore Central Valley wetland habitat, and it has laid the foundation for many significant and beneficial conservation activities in subsequent years. Since 1992, delivery of adequate, suitable quality water to certain NWRs, WAs and the private wetlands of the GRCD through CVPIA has improved wetland habitat quality and benefited many wetland-dependent wildlife populations, including waterfowl, shorebirds, colonially nesting waterbirds, and several threatened and endangered species. Annual reports to Congress and a variety of studies and reports conducted by the USFWS and CDFW have documented these benefits:

- A 600% increase in waterfowl food production within the GRCD (USBR and USFWS 2004).
- An 89% reduction in avian disease outbreaks on the Sacramento NWR Complex since 1992 (USBR and USFWS 2004).
- A 49% increase in fall shorebird use Central Valley-wide (M. Wolder, personal communication, 2012, see "Notes").
- A 50% increase in the number of heron and egret rookeries at Kern NWR (D. Hardt, personal communication, 2004, see "Notes").
- A 61% increase in visitor use on the Sacramento NWR Complex between 1992 and 2006 (USBR and USFWS 2004).
- Increases in non-waterfowl species such as the western pond turtle, as well as some threatened or endangered species (e.g., tricolored blackbird and giant garter snake) on Central Valley refuges (USBR and USFWS 2004).
- Marked increases in populations of white-faced ibis and sandhill cranes. Ibis populations increased from 100 birds in 1991 to 15,000 in 2002 at the Sutter NWR; sandhill cranes at Pixley NWR increased from 200 in 1992, to 2,000 in 1993, to 5,000 in 2001 (USBR and USFWS 2004).
- The Agricultural Waterfowl Incentive Program, CVPIA 3406 (b)(22), funded the flooding of an average of 40,000 acres of agricultural lands each winter between 1997 and 2003, providing a substantial portion of the annual waterfowl energetic need within the Pacific Flyway during that time (USBR and USFWS 2004).

These habitat improvements have led to research by universities, government agencies, and non-governmental



California black rail - Philip Robertson

conservation organizations such as the California Waterfowl Association; Ducks Unlimited, Inc.; Point Blue Conservation Science; University of California, Davis; United States Geological Survey's Biological Research Division, Dixon Field Station; and others that cite the benefits of refuges and the water that creates those wetlands.

Despite these benefits, the CVPIA mandated water supply levels have never been fully achieved, due in large part to state and federal budget shortages, inconsistency in the timing of water deliveries, and increases in the cost of blocks of water made available annually from willing sellers on the open market, also known as the "spot market." Budgetary constraints within USBR's annual CVPIA Restoration Fund and the state's past inability to cover their 25% cost-share mandate, required by CVPIA, have restricted the amount of Level 4 water supplies that can be acquired each year. At the same time, water costs have escalated as water acquisitions to meet CVPIA, urban, and agricultural needs have influenced sharp increases in spot market prices, further stressing limited budgets.

Budget shortfalls have also inhibited the ability to complete the construction of conveyance facilities necessary to deliver water to refuge boundaries. In some cases, conveyance facilities to provide water delivery to the property boundary are still awaiting construction.

Although the future of the Restoration Fund is still uncertain, public funding through state bond measures was dedicated in November 2014 to support CVPIA refuge-related expenses. This development has expedited progress on some conveyance and water acquisition projects. The Refuge Water Supply Program will complete a Strategic Plan that identifies priority projects and opportunities to achieve Full Level 4 water supplies as quickly as possible, creates an adaptive management decision tool, and outlines likely funding needs.

and the GRCD, the IRWMT meets regularly, collaborating on the acquisition and allocation of incremental water supplies necessary for wetlands to operate at full habitat development levels (Level 4) and other wetland water related issues. The IRWMT has invited a representative from the CVJV to regularly participate in team meetings, collaborate on refuge water strategies, and convey a broader view of how refuge habitat contributes to meeting the CVJV's valley-wide objectives.

The CVPIA statutorily obligates the Secretary of Interior to consult with the CVJV in matters involving wetland water acquisition and delivery. Considering this obligation, the CVJV maintains a unique responsibility to consider water supply issues related to the implementation of this 2020 Plan by participating in forums where water issues and policies are being discussed, to assure that policy makers address wetland water needs.

Development of water supplies for private wetlands and other wetland habitat lands

The CVPIA directed the U.S. Department of the Interior to provide firm water supplies to the 19 critical wetland complexes that include 18 federal and state refuges and the private wetlands within the GRCD, but these lands account for only one-third of the managed wetlands in the Central Valley. The CVPIA also identified additional wetlands as key components of habitat needed for birds and other species in the Central Valley, and it identified specific actions and investigations to assess water needs and water supply opportunities for these wetland areas.

Habitat provided by postharvest-flooded agricultural land, particularly postharvest rice, benefits waterfowl, shorebirds and a variety of other wildlife species and grew exponentially in the 1990s. It is the largest component of the wetland habitat mosaic today. Rice straw is high in silicate and other components that make it difficult to decompose, and straw left over from the previous harvest must be eliminated prior to the subsequent growing season. Before the 1990s, removal of rice straw was primarily achieved through burning, but air quality impacts led the legislature to mandate a phase-down of burning. The CVPIA Section (b)(22) established an incentive program for farmers to flood postharvest rice. Winter flooding provided an alternative and relatively cost-effective method of decomposing rice straw at a time when growers were unfamiliar with other methods.

By the early 2000s, postharvest flooding became the principle means of rice straw decomposition. At that time, 70 percent of the planted rice acres, or approximately 350,000 acres of harvested rice fields, were winter-flooded. A win-win for agriculture and the environment, winter flooding of rice also provides food for ducks, geese and shorebirds and provides habitat for millions of migrating waterfowl and shorebirds.

The Central Valley Wetlands Water Supply Investigations – Final Report (USFWS 2000), required by CVPIA (Section 3406(d)(6)(A,B)), reported to Congress on the adequacy of and needs for water supplies to existing private wetlands; on the water supply and delivery requirements to permit full habitat development on 120,000 acres of supplemental wetlands (public or private); and on feasible means of meeting those requirements.

Many private wetlands were developed on lands that were difficult to farm and did not have firm water supplies, water rights, or even wells. Water supplies to private wetlands were developed primarily by connecting to drains from local agricultural lands; establishing easements with farmers who agreed to flood land with water supplies available to them; pumping groundwater on-site; or more recently for many wetlands, by working with local landowners to pump or exchange groundwater to flood up wetlands. The water needs in the Water Supply Investigations report were based in part on CVJV's 1990 Implementation Plan goal for 120,000 acres of additional supplemental wetlands.

Central Valley Wetland Water Supplies Today

Today, a variety of surface and groundwater sources supply water to Central Valley wetlands. In the Central Valley, the great majority of wetland acres are irrigated with surface water supplies. The surface water supplies available in a given year can be correlated with precipitation received in the Central Valley and Sierra Nevada, with the “water year type,” a classification that accounts for precipitation over the wet season (from October through about May), and with water storage levels in reservoirs. Water rights also drive the availability of water and vary depending on the type of water right a parcel might have. Inter-annual water variability presents challenges as well as opportunities for wetland water supply management. More broadly, many Central Valley wetland water supplies are not secure and face several challenges as the demand for this highly managed but scarce resource increases, as water costs increase, and as shifts in climate and

ENTITLEMENT OR SUPPLY SOURCE	DESCRIPTION
Central Valley Project (CVP) Contracts	Contractual allocation of CVP's annual water supply. Five separate CVP contracts provide Level 2 supplies for CVPIA refuges.
State Water Project (SWP) Contracts	Contractual allocation of a portion of the SWP's annual water supply.
Pre-1914 Appropriative	Right to divert specific quantity, to specific location, for specific purpose(s). Right holder can provide evidence of original use prior to 1914 and continued use thereafter. More senior than rights granted after the passage of the Water Commission Act of 1913, Appropriative rights are often used by CVP and SWP contractors for winter water supplies (such as for rice decomposition) after October 1.
Post-1914 Appropriative	Right to divert specific quantity, to specific location, for specific purpose(s). Granted by what is now the State Water Resources Control Board (SWRCB) after the passage of the Water Commission Act. Seniority determined based on year granted. Appropriative rights are often used by CVP and SWP contractors for winter water supplies (such as for rice decomposition) after October 1. May be subject to Term 91 ^a in drier years.
Riparian	Right of landowner of land located adjacent to surface water, to use the natural flow of the watercourse to meet needs of that land. This water cannot be stored, leased or assigned another place of use. May be used as a source for some wetland or riparian bird habitats when that habitat is located adjacent to a watercourse.
Banked	Contract for right to surface water stored underground as a groundwater banking facility. Not common as a wetland water source.
Tailwater	Not an established right under the SWRCB, but tailwater was a major source of wetland water prior to construction of the CVP and SWP. Chemicals in tailwater also led to ecological damage near Kesterson in the late 1980s, resulting in mitigations and water supply replacements specified in CVPIA and the San Joaquin Basin Action Plan/Kesterson Mitigation Action Plan (USBR et al. 1989). Tailwater is still a significant source of supply to many private wetlands, especially in the Sacramento Valley. Reductions can occur from water use efficiency measures implemented upstream.
Surplus flows	Wetland management may have (or could apply for) an appropriative right from the SWRCB for surplus flows, such as storm flows. Typically, these flows would only be available from December through March in above normal or wet years, and timing is not guaranteed. Access may be constrained by agricultural operations that may shut down in winter when not being used for irrigation, or by irrigation districts that close water delivery canals for annual maintenance ^b .
Recycled water	Some wetlands are supplied with recycled water through a contract with the recycled water managing entity, such as through the North Valley Regional Recycled Water Program.
Groundwater	Groundwater is an important source of water for some Central Valley wetlands. Pixley NWR, for example, currently relies on groundwater for 100% of its water supply. As SGMA is implemented, groundwater use in some areas of California, including at some wetlands, will be severely restricted.

^a Term 91 is a condition of a water right that requires the user to cease diversions under the permit or license when noticed by the State Water Board.

^b Surplus flows are also important for fish migration at certain times of year, which presents a challenge, but return flows from wetlands can also provide additional river flow if timed to meet fish needs.

TABLE 4.2.2 Water rights and other wetland water sources.

aging infrastructure force reconsideration of water management regimes (Matchett and Flekes 2017).

The CVJV has confronted these water challenges by working collaboratively with partners on the ground; creating sophisticated spatial management tools to understand habitat availability in real time; and developing creative, science-based, multi-benefit approaches to providing reliable wetland water.

This section provides an overview of wetland water sources, the water needs of different wetland types (both by acre and the total needed to meet CVJV population targets), and the timing of those needs; and discusses the extent to which those needs are currently being met.

Sources of wetland water

At different times of year, surface water is applied or

groundwater is pumped to meet wetland habitat needs, either directly for that purpose (e.g., a contracted water delivery to a refuge) or indirectly to meet other needs. For example, flood irrigation of pastures and other crops benefit shorebirds, and rice fields flooded in summer provide brood habitat. Also, postharvest flooding in fall and winter benefits non-breeding waterfowl. Precipitation and uncontrolled flood water may also create wetland conditions, but managed wetlands and postharvest-flooded croplands, the focus in this section, typically rely on developed and applied water supplies.

Wetland water supplies vary widely in terms of the water source and the type and seniority of water right, which in turn affect the reliability of the water delivery. For example, a portion of water delivered to CVPIA refuges by means of CVP water supply contracts has typically been reliable except during extreme droughts. Conversely, drain flows (tailwater) that supply some duck clubs may literally “dry out” when upstream agricultural districts implement a “no discharge” policy or water use efficiency measures that reduce drain flows.

Various Central Valley wetlands may rely on numerous different water supplies (Table 4.2.2).

Wetland water needs

The timing and amount of water needed to create the necessary habitat conditions to support waterfowl, shorebird and other waterbird populations at goal levels in the Valley depend on:

- The waterfowl, shorebird or other waterbird population that must be supported at different times vary throughout the year because of such things as life stage requirements or migration chronologies.
- What kind and how much habitat (acres) is needed to support those populations.
- The amount of water needed per acre of habitat type in specific planning regions to support a given population.
- Where and when the water must be provided to create the needed habitats.

Generally, for migratory waterfowl, depths of 4 to 10 inches of water (NRCS et al. 2007) are required to create suitable habitat conditions during the peak migration and wintering period between August and March. Water is also required from April through August to maintain moist soil condi-

tions, germinate seeds and maintain wetland plants, irrigate rice to meet waterfowl energy needs during the winter months, and provide nesting and brood rearing habitat.

Nonbreeding shorebirds require shallower water depths (mudflat to 4 inches) than waterfowl. Shorebirds typically find habitat on managed wetlands and winter-flooded rice, when flooding begins, and late in the season during draw-down, when water recedes. Breeding shorebirds nest adjacent to shallow water in managed wetlands and rice. But in general, the flooding and drawdown schedules of managed wetlands and winter-flooded rice are more consistent with the needs of waterfowl than shorebirds in the Central Valley.

HABITAT TYPE	UNIT WATER NEED (ACRE-FT/ACRE)	TIME PERIOD
Seasonal wetlands	5.1	August through March, with irrigations in June
Semi-permanent wetlands	7.4	October through mid-July
Flooded rice		
Winter flooding (for rice straw decomposition)	2.5	October through December
Growing rice (prior to winter flooding)	5.0	April through September

TABLE 4.2.3 Wetland water needs by habitat type (supply needed for full annual cycle) (USBR et al. 1998; USFWS 2000; UC Davis 2019).

The water needs of other waterbirds, such as egrets, ibises, cranes and terns, vary widely by species, as detailed in the Breeding and Non-Breeding Waterbirds chapter.

In general, the quantity of water needed per acre of habitat depends on the wetland type – seasonal wetland, semi-permanent wetland, or flooded rice – and the depth and duration of flood most suited to waterfowl or shorebird needs. The comprehensive Central Valley Wetlands Water Supply Investigations Report to Congress (USFWS 2000) in December 2000 presented monthly water needs for seasonal and semi-permanent wetlands by drainage basin and the timing and rate at which these wetlands are flooded and maintained. Based on the information in this report and other sources, approximate annual water needs are summarized by habitat type in Table 4.2.3.

The more precise need varies depending on soil characteristics, topography, location in the Valley, and other factors. For example, due to higher evaporation rates experienced in the southern Central Valley, habitats in the Tulare Basin typically have a higher water demand than in the Sacramento Valley. Also, rice fields located on more permeable soils may require more water to maintain a flooded condition than those overlying less permeable soils.

To maintain optimal conditions for non-breeding waterbirds on seasonal wetlands, approximately 5.1 acre-ft/acre is needed per year. This water is typically applied from August through March, with one or two irrigations between April and July to ensure adequate seed production by moist soil plants.

Approximately 7.4 acre-ft/acre is needed per year to meet the needs of locally breeding ducks and other waterbirds. Water is applied for flooding from October through mid-July, including maintenance flows to offset evapotranspiration.

Flooded rice fields contribute a critical percentage of wetland habitat in the Valley. Winter-flooding requires 2.5 acre-ft/acre (M. Petrie, personal communication, 2016, see “Notes”) of applied water throughout the postharvest season to promote straw decomposition and provide waterbird habitat. Applying this water between October and January corresponds to peak waterfowl habitat needs (M. Petrie, personal communication, 2016, see “Notes”). Applying the water earlier, from September (or earlier, though this is not possible unless rice is harvested atypically early) to October, provides habitat for shorebirds as they arrive in the Central Valley from more northern breeding areas (Dybala et al. 2017). Most of this water either percolates into the ground or drains as tailwater in early spring, returning to the system for other downstream uses.

Water is also needed to flood and grow the rice that eventually provides the fall and winter habitat for waterfowl and shorebirds. Growing rice requires approximately 5 acre-ft/acre (UC Davis 2019), applied between April and early September. The consumptive use of this water by the crop is about 2.8 acre-ft/acre, with the remaining evaporating, percolating into the ground or draining as tailwater spill at the end of the irrigation season, returning to the system to support other uses downstream.

Shorebirds need habitat at times that do not coincide with the time when rice fields are typically flooded postharvest. If the shorebird population reached the long-term objective, additional habitat would be particularly critical in the fall (late July to September) and spring (mid-March to April) (Dybala et al. 2017). Idled fields could be shallowly flooded in late July

through August, prior to when other habitat would be flooded, and in March through April, after other habitats are drained, to make up for these shortfalls. Seasonal wetlands could also be managed, particularly on refuges, specifically to provide habitat during these time periods. Willing agricultural or refuge partners and supplemental water supplies would be needed to support these practices on the landscape.

Several CVJV partner organizations participated in a collaborative analysis to describe the water needs of Central Valley fish, waterfowl, shorebirds, and the giant garter snake, on a semimonthly basis, upstream of different control points in the Sacramento River watershed and Sacramento-San Joaquin River Delta. The annual hydrographs developed for this effort were informed by and built on the CVJV’s assessment of bird habitat needs (objectives). These hydrographs (Figures 4.2.1 – 4.2.4) are presented here to illustrate the approximate pattern of Central Valley waterfowl and shorebird water needs over the course of a water year (starting in October).

Figure 4.2.1 presents the total water needs patterns of waterfowl and shorebirds, including all habitat types, from the Sacramento River watershed upstream of the American River confluence. Referred to here as the Sacramento Valley, this watershed roughly corresponds to the CVJV’s Sacramento planning region. Figure 4.2.1 includes the water needed to grow the acres of rice that must later be flooded to provide adequate bird habitat.

Figure 4.2.2 breaks out the waterfowl water need in this area by habitat type. Note that the water needed for winter-flooded rice habitat has two components: water used for irrigation to grow the rice that will be winter-flooded, and water used to flood the fields postharvest. Note that more rice is grown than can be flooded. So, to estimate the water used for irrigation, only the volume of water needed to inundate lands that actually become (are later flooded for) habitat for wildlife was incorporated into the estimate of water needed for wildlife needs.

The timing of these water diversions between April and the first half of September is assumed to be proportional to a typical delivery pattern of the Sacramento Valley Settlement Contractors, who grow the majority of rice in the Sacramento Valley (pattern adapted from Sacramento Regional Water Management Plan, January 2007 and personal communication with Thad Bettner, GCID: T. Bettner, personal communication, 2016, see “Notes”).

Figure 4.2.2 shows that water needed to grow rice and subsequently flood that rice in winter comprises the largest volume of water needed of all habitat types. Flooded rice fields provide over 60 percent of the food resources available to ducks and

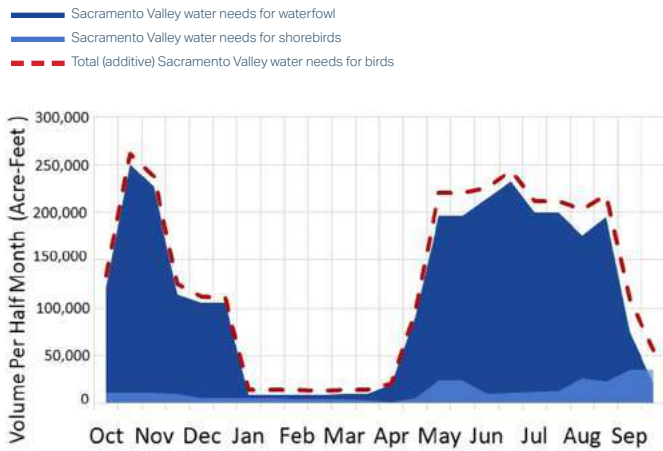

FIGURE 4.2.1 Semimonthly waterfowl and shorebird water needs from the Sacramento River watershed upstream of the American River confluence. The dashed line shows the sum of these needs.

geese in the Central Valley, with refuges, managed wetlands and harvested corn fields typically providing the rest. It is important to note that rice and corn must not only be grown but also winter-flooded to make food resources fully available to birds.

Figure 4.2.3 presents the total water needs pattern of both waterfowl and shorebirds including all habitat types from the Delta, San Joaquin, and Tulare Basins. Although proportionally small, water needed to grow the acres of rice that must later be flooded for birds is also included here.

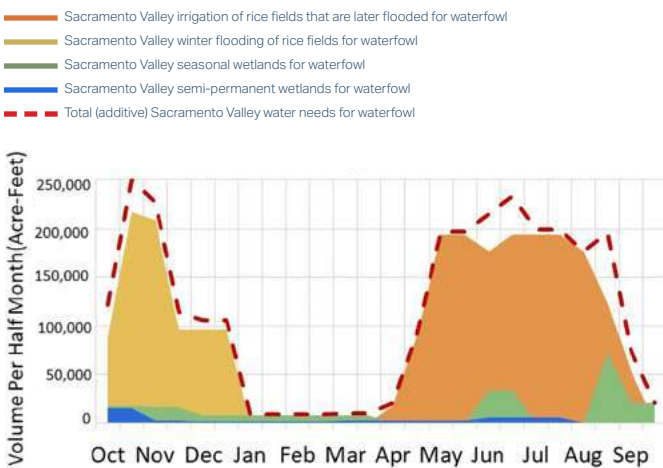

FIGURE 4.2.2 Semimonthly waterfowl needs from the Sacramento River watershed upstream of the American River confluence: Breakout of water needed to grow rice and winter flood post-harvest for habitat. Only the water needed to grow the rice that is later winter-flooded is included. The dashed line shows the sum of these needs.

The water needs of refuges are a component of the seasonal and semi-permanent water needs for waterfowl and shorebirds presented in the previous figures. Figure 4.2.4 presents these refuge water needs (assuming optimal water supplies required by CVPIA are available) both in the Sacramento Valley and in the San Joaquin and Tulare Basins.

These figures illustrate the general pattern of water needs at the CVJV's current acreage targets for each habitat type. The water supplies available to each of these wetland types may vary from year to year. The next section describes the availability and reliability of these water supplies by wetland type, followed by the challenges and opportunities for increasing those supplies to achieve the target water needs.

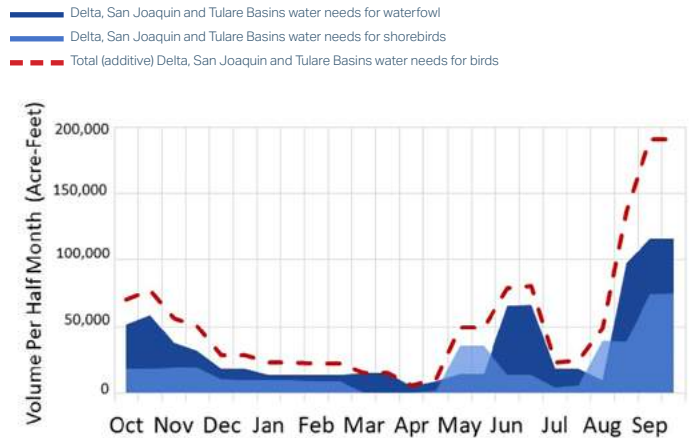

FIGURE 4.2.3 Semimonthly waterfowl and shorebird water needs in the Delta, San Joaquin and Tulare Basins. Dashed line shows the sum of these needs.

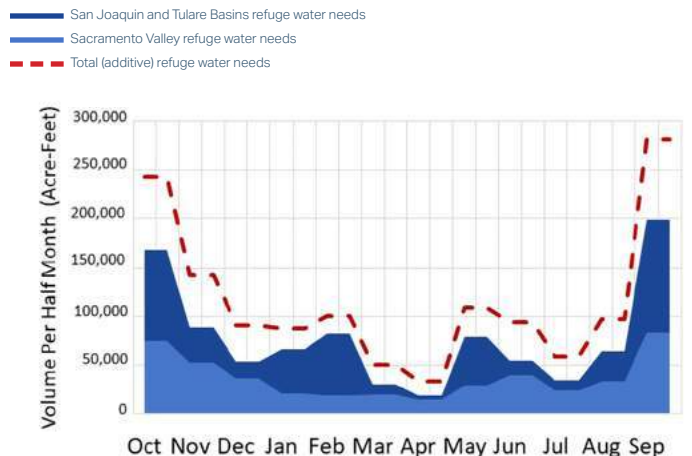

FIGURE 4.2.4 Semimonthly refuge water needs in the Sacramento, San Joaquin and Tulare Basins. The dashed line shows the sum of these needs.

Meeting wetland water needs: current status

In some areas of the Central Valley, existing wetlands with reliable water supplies may receive enough water in wetter years to support best management practices. But in other areas and in drier years, water supplies are uncertain at best and not available at worst, leaving important wetland habitat dry and impacting its productivity for years to come. This section describes the extent to which CVJV partners and Central Valley land managers are providing the water necessary to meet habitat objectives on managed wetlands and winter-flooded agricultural land. The section also identifies particular gaps with respect to water supplies.

CVPIA-covered federal refuges, state wildlife areas, and the GRCD

The CVPIA directs the U.S. Department of the Interior and the state of California to provide adequate, reliable water to 19 Valley refuges, hereafter termed “CVPIA refuges.” Included are the 14 National Wildlife Refuges in the Valley; the Gray Lodge, Los Banos, Volta, and Mendota Wildlife Areas; and the GRCD. But on average, only half of the spring and summer water required to meet the needs of wildlife is delivered. Far less water is delivered to refuges in drought years, especially in the San Joaquin Valley.

Water supplies required by CVPIA have never been fully delivered to all refuges because of several physical and institutional challenges. Most CVPIA refuges receive a portion of their water supply (their “Level 2” supply) with a reliability that has, to date, matched that of senior CVP contractors. However, total water deliveries show a declining trend over the years, particularly with respect to Incremental Level 4 supplies (Figure 4.2.5).

According to delivery records through 2018 maintained by the Refuge Water Supply Program, an average of 422,000 acre-ft has been delivered to CVPIA refuges annually since 2002 (USBR, personal communication, 2017, see “Notes”).

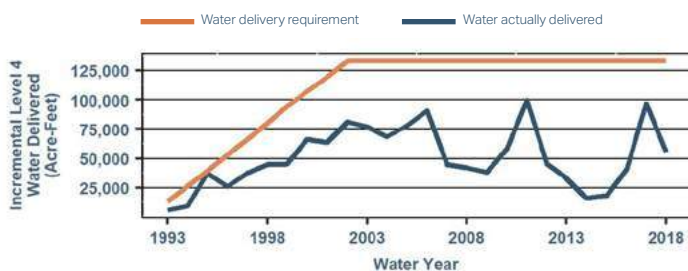

FIGURE 4.2.5 Water supplies acquired for refuges show a declining trend. Red line shows Incremental Level 4 water delivery requirement; blue line shows water actually delivered.

	UNMET WATER NEED (ACRE-FT)	CONSTRAINT
SACRAMENTO VALLEY		
Sacramento National Wildlife Refuge Complex		
Sacramento National Wildlife Refuge	-	
Delevan National Wildlife Refuge	-	
Colusa National Wildlife Refuge	-	
Sutter National Wildlife Refuge	15,900	Infrastructure
Gray Lodge Wildlife Area	8,600	Infrastructure
SAN JOAQUIN VALLEY		
San Luis National Wildlife Refuge Complex		
San Luis Unit	-	
West Bear Creek Unit	3,200	Acquisitions
East Bear Creek Unit	9,800	Infrastructure, acquisitions
Kesterson Unit	-	
Freitas Unit	-	
Merced National Wildlife Refuge	-	
Kern National Wildlife Refuge	7,200	Acquisitions
Pixley National Wildlife Refuge	4,700	Infrastructure, acquisitions
Volta Wildlife Area	2,700	Infrastructure
Los Banos Wildlife Area	4,600	Acquisitions
North Grasslands Wildlife Area		
China Island Unit	1,400	Acquisitions
Salt Slough Unit	1,300	Acquisitions
Mendota Wildlife Area	1,400	Infrastructure, acquisitions
Grassland Resource Conservation District	19,700	Acquisitions
Subtotal	80,500	
Estimated average 15% carriage loss	12,100	
Total	92,600	

TABLE 4.2.4 CVPIA Refuges: Average water needs and constraints (rounded to the nearest 100 acre-ft (E. Wehr et al., unpublished report, 2017, see “Notes”).

This is the Full Level 2 water supply historically delivered to refuges. The total amount required by CVPIA for optimal habitat management, known as Full Level 4, is 555,000 acre-ft. The difference between the Full Level 4 and Full Level 2 amounts is 133,264 acre-ft and is known as the Incremental Level 4 (IL4) amount. While the L2 amount is very reliable, supplied mostly via CVP yield, the Refuge Water Supply Program purchases a portion of the IL4 every year. (This is considered “applied water use” and does not account for return flows or seepage to maintain groundwater conditions in underlying aquifers.)

Delivery shortfalls reduce the habitat contribution these refuges could make to the overall mosaic of wetland habitats needed to support resident and migrating bird populations in the Central Valley. Without these deliveries, other wetland types must provide additional acres to make up for the habitat shortfall, or bird populations could be impacted.

The CVPIA refuges that are chronically short of water or those that face particular water supply challenges include Sutter NWR and Gray Lodge WA in the Sacramento Valley; and Kern NWR, Pixley NWR, Los Banos WA, North Grasslands WA, units within the San Luis NWR Complex, and GRCD in the San Joaquin Valley and Tulare. Table 4.2.4 lists water-short CVPIA refuges, approximate individual water needs, and whether those needs must be met through infrastructure investment or water acquisition. Note that water needs expressed are averages; needs in dry and critical years are higher.

Other public and private non-CVPIA Refuge wetlands

Approximately two thirds of the managed wetlands in the Central Valley do not have a contract for water through the CVPIA. These seasonal wetlands are privately managed, most as “duck clubs,” and they access developed water through a variety of water rights or incidental water supplies such as runoff or tailwater. Many private wetland managers rely on water supplies that are reduced in below-average water years, depend on return flows from agriculture, and/or are provided with contracts between water purveyors and federal or state agencies. Therefore, the water supplied to these wetlands and the extent of habitat may vary from year to year.

Water supplies available to these privately managed wetlands are deficient in some years and may be declining. In general, water supply deficiencies to these wetlands tend to occur during the fall flood-up period from September through November, and throughout the winter, when maintenance flows are needed to maintain flooded conditions. Wetlands could and do acquire rights to natural surplus flows from the SWRCB. However, as described previously, flows are typically only available from December through March after winter rains begin and are not available for September flood-up.

Tailwater from rice fields being drained in the fall is the source of water supply for 45,000 acres (approximately 56 percent) of the seasonal wetlands in the CVJV Sacramento planning region (Petrie and Petrik 2017). Some wetlands that rely on tailwater from agricultural operations are experiencing a reduction in supply as water use efficiency measures are implemented or as rice or row crops are converted to orchards. Refuges are experiencing similar challenges.

Wetland managers may also be reliant on operational conveyance facilities and drains to receive their water supplies. These facilities may shut down for maintenance activities when not being used for agricultural irrigation in fall and winter, which is typically when wetland water demands are highest.

Agricultural habitats

The largest portion of non-breeding wetland dependent bird habitat in the Central Valley is now provided by agriculture, especially postharvest-flooded rice in the Sacramento Valley and, to a lesser extent, corn in the Delta Basin. Over the last few decades, migratory birds have increasingly relied on a mosaic of surrogate, temporary habitats outside of protected managed wetlands. These habitats include compatibly managed, seasonally flooded private agriculture lands.

Each year, approximately 550,000 acres of rice are planted in the Sacramento Valley and are used as breeding habitat. In a typical fall and winter, around 350,000 acres of this rice land is flooded intentionally as one way to promote decomposition of rice straw and create migratory bird habitat, as discussed previously. This acreage provides up to 50 percent of the food resources for waterfowl in the Central Valley (see the Non-Breeding Waterfowl chapter). Harvested corn crops also provide habitat and food benefits for waterfowl. In the Delta Basin, approximately 30,000 acres of corn are grown each year. This corn acreage provides roughly four percent of the food resources available for waterfowl in the Central Valley and is also especially important to sandhill cranes.

While much of the habitat provided by agriculture is used by birds in the fall and winter, creating this habitat and additional breeding habitat requires year-round water supplies. For example, starting as early as April, water is required to flood up rice fields for planting. In the spring and summer months, reliable and timely water supplies are necessary, both to cultivate the crop and to maintain breeding habitat. Once the crop is harvested, additional water supplies must be delivered to flood the fields to promote decomposition of rice straw and make waste grain accessible as food for birds. This winter flooding comes at a critical time when birds need to refuel for long migrations back to northern breeding grounds. Usually in February and March, the fields are drained and dried prior to planting, and the cycle begins again.

Most of the rice grown in the Sacramento Valley relies on surface water from the Sacramento River through CVP Settlement Contracts or Agricultural Service Contracts, or from the Feather River through State Water Project contracts. These contracts have provided relatively reliable water to grow rice in all but very dry and critically dry years. Access to water supplies in winter months for flooding fields can be limited by the lack of a right or contract to divert water, the relative priority of a winter water right, the terms of the water supply contract, reservoir operations, and other water management conditions. Therefore, although water supplies for growing rice have been relatively reliable, water supplies to flood rice fields postharvest and create habitat conditions are generally less reliable, especially in dry years and during droughts.

Trends indicate that winter flooding may decline both overall and as a percentage of rice acreage grown. Reasons for this decline include reduced water availability (whether real due to actual water curtailments or merely predicted in a given year), increased grower familiarity with dry incorporation methods, a growing market for rice straw (such as for fiberboard manufacturing), and other economic reasons. Some of these challenges are described in the Non-Breeding Waterfowl chapter.

Wetland Water Supply Challenges

Many significant factors limit wetland water supplies now and they will continue to challenge habitat and natural resource managers into the future. Broadly, the primary water challenges facing both private and public wetland managers in the Central Valley are: (1) maintaining and increasing the reliability of water for wetland management, both quantity and quality; and (2) ensuring that funds for water supplies cover the increasing costs of water. Even CVPIA refuges that were guaranteed firm water supplies by Congressional action

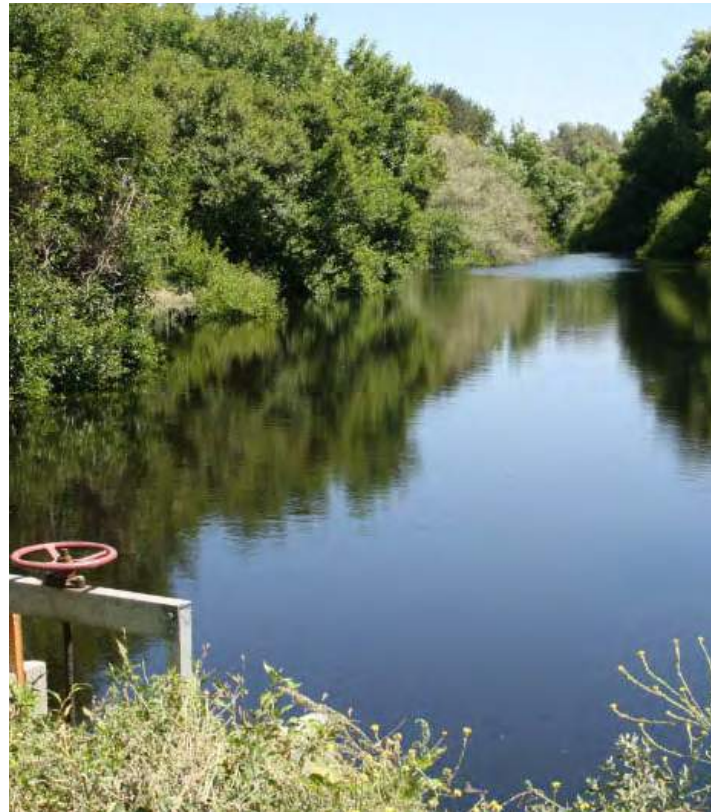

Lower Riley Slough on Faith Ranch: Water levels managed for bird habitat on private conservation-easement land - Gary Zahm, Faith Ranch

are limited in their ability to receive adequate water supplies. (Many of these challenges were described in detail in a report entitled “Undelivered Water: Fulfilling the CVPIA Promise to Central Valley Refuges” [CVPIA IRP 2009].) The challenges described in this section currently restrict or impair wetland water supplies or funding, or they will do so if not proactively addressed. The next section will discuss potential opportunities that could address these challenges.

Refuge water conveyance

Most CVPIA Refuge managers depend upon water being conveyed to them through local water or irrigation districts to the refuge boundary. These districts needed improvements or expansions to their infrastructure for them to meet the individual CVPIA Refuge needs in their area, while also serving the ongoing needs of their own landowners. Construction and conveyance agreements were negotiated between these districts and the USBR so that these improvements could take place.

Refuge water funding limitations and other challenges

The CVPIA Restoration Fund is the primary source of funding for CVPIA refuge water supply acquisitions, water conveyance rights, and infrastructure projects. It is funded

by USBR's collection of environmental mitigation fees from CVP water and hydropower customers and is supplemented by contributions from the state. Approximately half of the \$50 million annual fund is allocated to the CVPIA Refuge Water Supply Program each year. One challenge associated with the CVPIA Restoration Fund is the unpredictable nature of annual collections and appropriations. Various proposals to address the problem have been advanced. Any proposal to reform the Restoration Fund must be designed to preserve and enhance its ability to provide needed water supply to managed wetlands.

Another funding challenge is that federal and state budgets are unable to keep up with the increasing costs of water and the costs of maintaining reliable infrastructure on refuges. Although more permanent sources of Level 4 refuge water supply are under development, the majority of Level 4 refuge water is purchased on a year-to-year or "spot-market" basis. Increasing demands for water coupled with less water available in storage, on average, has resulted in higher water prices, reducing the amount of water that the program can acquire on an annual basis within its current budget. Costs for both permanent water rights and spot-market water are likely to continue to rise in the near future as groundwater users are increasingly forced to look to surface water supplies with the implementation of the Sustainable Groundwater Management Act. The Sustainable Groundwater Management Act of 2014 (SGMA) requires governments and water agencies of high and medium priority basins in California to halt overdraft (if it exists) and bring groundwater basins into balanced levels of pumping and recharge. This trend will further increase pressure on the Refuge Water Supply Program to provide adequate water to meet refuge needs.

Droughts and climate trends

Droughts are a fact of life in California, but recent severe droughts have brought more attention to the potential and real impacts droughts can have on waterbird habitat in the Central Valley, a region that has lost so much available habitat over the last 150 years.

2. The State Water Resources Control Board and other water managing agencies made water allocations decisions for the 2015 water year that attempted to balance available and anticipated water storage and the water needs of cities, agriculture, and the environment. Ultimately, water managers decided that Settlement Contractors (Sacramento Valley) and Exchange Contractors (San Joaquin Valley) would receive 75% and 65% of their contracted supplies, respectively, but more junior water rights holders throughout the Valley would receive 0%. On par with those contractors, CVPIA refuges were allocated 75% of Level 2 supplies (which are CVP project supplies) north of Delta and 65% of Level 2 supplies south of Delta, but this represented much less than "optimal" Level 4 water supplies to these refuges. Kern NWR, for example, received less than one-third of its Full Level 4 water supply.

Drought impacts Central Valley wetland habitat in several ways. During a drought, water supplies are often curtailed to agricultural crops, an action that affects wetlands both directly and indirectly. Crops that may otherwise have directly provided postharvest-flooded habitat may be fallowed if water supplies are unavailable that year. Tailwater that would have otherwise flowed to supply some seasonal wetlands may be unavailable if irrigated field crops are fallowed or if "no water release" efficiency measures are implemented. Water supplies may also be curtailed to refuges, or unavailable or too expensive to purchase on the spot market, ultimately reducing wetland extent and/or food production at refuges.

Different regions of the Central Valley experience different levels of drought impact in terms of the extent of open water habitat available to birds. For example, studies found that in the Tulare and San Joaquin Basins, the amount of open water declined almost immediately in the fall/early winter following a drought water year, whereas several consecutive years of drought occurred before the Sacramento Valley experienced changes in the extent of open water. The Yolo-Delta and Suisun Planning Regions were generally unaffected by drought in terms of open water extent (Reiter, Elliott, Veloz et al. 2018). Contributing to the resiliency of the Sacramento Valley to drought is the availability of waterbird-compatible crops like postharvest-flooded rice, and senior water rights and policies such as Area of Origin that apply in the Sacramento Valley. Habitat south of the Delta, especially on refuges and private seasonal wetlands in the San Joaquin and Tulare Basins, may be more at risk during droughts.

California sustained an extreme drought between 2013 and 2015. During this lengthy drought, water supplies to wildlife-compatible agriculture and to managed wetlands and refuges were more severely curtailed than water supplies to other uses². A recent study based on satellite imagery found up to 80 percent declines in postharvest-flooded agriculture and 60 percent open-water declines in managed wetlands compared to non-drought years (Reiter, Elliott, Jongsomjit et al. 2018). In 2014-2015, it was estimated that only 10 percent of wetlands were irrigated in summer. This low water supply level can result in a 44 percent decline in food production on non-irrigated wetlands (Petrie et al. 2016). During that season, avian disease outbreaks were prevented in part as a result of collaboration across refuges, coordination of water management and regulatory efforts by water agencies and the agricultural community to maximize value of limited water supplies, and incentive programs which, on average, provided 35 percent of the available habitat on the landscape and up to 100 percent of the habitat on some days during the drought (Reiter, Elliott, Jongsomjit et al. 2018). Some

research evaluating impacts of future scenario projections through year 2099 indicated that several regions in the Central Valley may require additional conservation to support summer irrigation of seasonal wetlands and winter-flooding of cropland habitats. San Joaquin and Tulare regions would become increasingly vulnerable to future impacts of water limitation, and similarly, habitats in some areas in the Sacramento Valley also would experience more frequent and severe effects of drought than historically (Matchett and Fleskes 2018).

CVJV partners responded to this drought by facilitating communication among wetland managers, studying the impact of drought on waterbird habitat availability, improving drought preparedness and response through scenario planning, recommending strategies to bolster habitat resiliency, and developing approaches to dynamically deploy habitat more efficiently and precisely when and where birds need it.

Climate trends indicate that severe droughts – as well as significant storm events and floods – may occur more frequently over the next 50 to 100 years (IPCC 2013; Diffenbaugh et al. 2015). CVJV partners can provide information on habitat impacts and needs to conservation practitioners and policymakers and develop strategies to ensure wetland habitat resiliency as these changes occur.

Rice decomposition trends and changes in agricultural practices

As described previously, the average amount of winter-flooded rice has decreased in recent years.

In 2007 and 2008, dry incorporation of harvested rice fields – that is, plowing or disking with no intentional flooding – reached peak levels (Miller et al. 2010). Growers may have thought less water would be available those years because previous winters were dry. Although water supply curtailments were ultimately not enacted, the growers planned ahead on a more reliable method. When normal water supply conditions returned in 2009, 50,000 to 60,000 fewer acres of rice was winter flooded than it had been at its peak, with a corresponding number of fewer acres available as habitat for migratory birds. Rice growers may also have been learning how to better incorporate rice straw into soil to achieve acceptable levels of decomposition even without flooding, and thus did not wish or could not afford to return to a less reliable method (CRC 2015).

The drought from 2013-2015 resulted in water supply reductions in much of the Sacramento Valley. These curtailments and other water management decisions, including

transfers to other agricultural water users, resulted in a significant decline in winter-flooded rice, especially in areas west of the Sacramento River. Reductions grew over each subsequent dry year. In 2014, although 424,350 acres of rice were harvested, it was estimated that as little as about 12 percent of those acres were postharvest-flooded, a 51 percent reduction from a typical year (Petrie et al. 2016).

Adding to these declines, and possibly in response to recent drought conditions that made winter flooding less viable, farmers have recently chosen to provide rice straw to a new state-of-the-art medium density fiberboard (MDF) manufacturing facility that is under development. This and other novel uses of rice straw offer rice growers alternatives to postharvest flooding.

Ultimately many rice growers may choose what decomposition method to use based on economics, convenience, and reliability. If the costs to winter flood increase due to rising water costs, labor, or other factors, or if water becomes less reliable and less convenient, incentive programs may be needed to encourage rice growers to reconsider the multiple benefits of winter flooding. See “New Public and Private Funding” below.

Groundwater regulation

Local stakeholders are forming Groundwater Sustainability Agencies to manage basins and develop Groundwater Sustainability Plans. Under SGMA, these groundwater basins should reach sustainability within 20 years of implementing their sustainability plans (CDWR 2019).

Some Central Valley wetlands, particularly in the southern San Joaquin and Tulare Basins, rely on groundwater as a source – and for some the only source – of water supply. These wetlands may have no other water rights or access to surface water supplies. Implementation of SGMA in these areas is likely to reduce groundwater availability to a fraction of what is needed to manage wetlands. For example, in some parts of the Tulare Planning Region, early estimates suggest that groundwater allocations will be set at roughly only 0.5 acre-ft/acre per year of consumptive use. Some basins are developing a credit trading system enabling some land within a basin to pump more groundwater while others use less. The demand for these credits by non-wetland water users is likely to put pressure on wetland managers politically or financially, affecting continuing wetland viability.

Participation in the development of Groundwater Sustainability Plans by wetland managers or their advocates

requires investments of time and funding to be sure that wetland water supply interests are accurately reflected in the basin water budgets and allocations.

Water management projects and regulatory processes

Ensuring that ongoing federal, state and local water management projects and regulatory processes account for wetland water needs requires significant time investment by wetland and natural resource managers and their advocates. These projects and processes often pose challenges to the wetland conservation community, but they also may present opportunities if the CVJV engages strategically.

Although the duration and ultimate resolution of these ongoing processes is difficult to predict, the following are examples of planning and regulatory processes that could affect the ability of the CVJV – for better or worse – to achieve the Implementation Plan objectives over the next 10 years.

- Bay-Delta Water Quality Control Plan Update
- Reinitiation of Consultation on the Long-Term Operations of the SWP and CVP
- WaterFix and EcoRestore
- SWRCB Wetlands Policy

Wetland Water Opportunities

CVJV partners have achieved a great deal of success working collaboratively on the ground to secure and restore new wetland habitat and to develop new ways to provide habitat on working lands. Securing and maintaining water supplies for this habitat, and developing ways to stretch existing wetland water supplies to achieve conservation targets, is also critically important, especially to confront the challenges described above. Strategic planning, funding and market-based solutions, and harnessing state-of-the-art technology and data are just some of the opportunities that can lead to better wetland water management and more resilient wetland water supplies.

Strategic planning

Given the challenges described in this chapter, it is important to use available resources (funding, time and water) as strategically as possible. To help with this, the Refuge Water Supply Program (RWSP) is undertaking a stakeholder strategic planning process, managed collaboratively by agency staff and some CVJV partners.

The resulting Strategic Plan will identify a path for meeting the full CVPIA refuge contractual obligations. The intent



Manager checking a water control structure at Twin Lakes Partners for Fish and Wildlife project - Shawn Milar

of the Strategic Plan is to set a prioritized program budget, schedule, and expectations for implementing the refuge water supply component of the CVPIA, with partner agencies and stakeholders in the shortest possible timeframe. The plan will also provide a tool for managers to assess potential projects and expenditure of resources as conditions change or new project opportunities develop.

New public and private funding

Funding is needed to address water supply shortfalls on refuges and to encourage water-related agricultural practices, such as winter flooding, on private lands. Funding mechanisms could include bond measures, tax credits, and other creative strategies.

Some recent bond measures have allocated billions of dollars to water projects that could provide wetland benefits, and other bonds have allocated millions directly to bird habitat conservation.

Creating private wetlands or supplying wetland water could also be encouraged through tax credits or other financial incentives. As discussed previously, as winter flooding becomes more expensive or less reliable as a method for disposal, incentives may be needed to encourage growers to continue to winter flood their rice fields.

Enhanced wetland water conservation and productivity

Implementing water conservation measures on wetlands must be done with an understanding of what the water needs are to support a particular function, or suite thereof. Discussions for achieving water efficiency should go hand in hand with discussions on desirable outcomes and the values obtained from dedicating water supplies for wetland habitat purposes. An increase in reliability and/or volume of water supplies delivered to a wetland may result in enhanced or additional beneficial uses of that wetland, measured in habitat and species diversity, caloric output, disease control, waterfowl body conditions, visitor days, recovered populations of listed species, etc. Any conservation measures implemented must not be detrimental to those outcomes, but rather be tied to achieving those same outcomes with less water.

One example of how managed wetlands can increase productivity with less water is by installing water recirculation infrastructure. Several CVPIA refuges have done so, and more projects are underway, including the Grassland Water District's North Grassland Water Conservation and Water Quality Control Project. This water recirculation project, funded through a partnership with San Luis Water District and a grant from the State of California, includes 18,000 feet of buried pipelines and three pump stations in the northern area of the GRCD, which will capture and recirculate an estimated average of 14,000 acre-ft of refuge water per year. The project will conserve water for delivery to approximately 8,000 acres of habitat.

Improved access to and participation in the water market

As described previously, managed wetlands, both public and private, typically rely on long-held water rights or water project contracts (such as those established following the passage of CVPIA), or on incidental return flows. These are critically important supplies that must be maintained. In addition, buying, selling and exchanging water with other water users within the Valley, and even exchanging water between different wetlands, may open doors that lead to increased overall water deliveries to wetlands. A few examples of how CVJV partners are pursuing these types of opportunities are highlighted below. During the course of this Plan, new projects and water deals will continue to be identified and achieved.

Direct water purchases

The Refuge Water Supply Program regularly acquires water from willing sellers to provide refuges with Incremen-

WATER TRACKER

Water Tracker is an open source, publicly accessible, near real-time assessment of open surface water in the Valley derived from remotely sensed data. Semimonthly, this automated system maps, quantifies and summarizes surface water in the entire Valley by cover type and by Joint Venture planning basin and these data are made available online (www.pointblue.org/watertracker). Development of the system involved engagement by wetland managers, conservation non-governmental organizations, and water districts throughout the Valley.

The information provided by the Water Tracker is timely and useful for deciding how best to allocate water across refuges and agricultural wetlands, providing benefits for wildlife and human communities.

The data provided by the Water Tracker has been used in combination with avian bioenergetics modeling to estimate the amount of different habitats available and needed by multiple species of waterbirds – and thus to inform the current CVJV habitat objectives. Also, it will soon be linked with other resource information (groundwater recharge potential, freshwater ecological diversity, distribution of threatened and endangered wildlife and other factors, for now and future projections) to create a spatially explicit and actionable conservation prioritization framework for the resource community.

Importantly, Water Tracker was used to assess patterns in open surface water during drought (2013 to 2015) in comparison with historical years (2000 to 2011) in habitats known to support wetland-dependent birds (Reiter, Elliott, Jongsomjit et al. 2018). The study found that the agricultural landscape had significantly less area of open water during the recent drought than during non-drought years. For example, rice growing areas showed as much as a 46% reduction in open water (particularly in February and March). The reduction in corn was as much as 80%. In rice, this effect was partially mitigated by precipitation, which had a significant positive effect on open water and was prominent in non-drought years. Seasonally managed wetlands showed about 50% declines in open water, largely observed between October and March.

In a warming climate, extreme conditions and extended droughts are forecasted to become more of the norm for California, making it increasingly difficult to meet the many demands for water in the state. Integrating current and accurate water science into state and regional decision-making processes is critical for sustaining healthy ecosystems and human communities into the future.

tal Level 4 supplies. Water is frequently acquired on the spot market as a single-year transaction, if and when water is available at prices the RWSP believes it can afford. Some multi-year agreements with entities such as the San Luis and Delta Mendota Water Authority have been negotiated, which provide the RWSP with a more predictable source of supply – at a more predictable cost – in most years. However, purchasing water in dry years, especially on the spot market, remains an expensive option. Additional permanent, reliable water supplies are needed, either through direct purchases or donations of water rights or contract reassignments. Funding for such purchases – and adequate capacity to identify, negotiate, and demonstrate the opportunities – is a critical need.

Recycled water

As the demand grows for limited water in the Valley, recycled water is emerging as a potential source of supply for municipal and agricultural water users, as well as for wetlands. Projects like the North Valley Regional Recycled Water Program promise to provide reliable and relatively inexpensive water supply for both agriculture and wetlands in the upcoming years by recycling water. As the population grows and more water is allocated for urban use (depleting current water sources for wetlands), more recycled water potentially will be available and could become an increasingly important water supply for flooded habitats. On a case-by-case basis, more study is needed to ensure that the wide range of biological, inorganic, and organic constituents that may cause water quality concerns when wastewater is reused are adequately addressed and that recycled water projects do not further harm wetlands or riverine ecosystems.

Water exchanges with other water users

The RWSP and GRCD have independently conceptualized and executed creative water exchanges, in which Level 2 surface supplies have been traded for a greater amount of groundwater. These exchanges take advantage of different demand timing – agricultural water users use surface water during the growing season, and in exchange they pump a greater amount of groundwater for refuges at other times of the year. While a creative potential win-win strategy to achieving additional wetland water supplies, potential water quality impacts and other issues must be considered and weighed when negotiating the deals.

Inter-refuge exchanges and transfers

CVPIA refuge managers strive to make the most of the water supplies available to them, and to work together to ensure that each refuge has access to adequate water to the extent practicable. CVJV partners continue to look for creative

CHALLENGES	OPPORTUNITIES	REGIONAL APPLICABILITY
Refuge water conveyance constraints	Strategic planning Enhanced wetland water conservation and productivity New public and private funding	Sacramento Valley San Joaquin Valley Tulare Basin
Refuge water funding limitations	Strategic planning Improved access to and participation in the water market New public and private funding	Sacramento Valley San Joaquin Valley Tulare Basin
Droughts and climate trends	Strategic planning A variety of approaches to deploying habitat Water-related habitat data and tools	All
Rice straw decomposition trends and agricultural practices	New public and private funding A variety of approaches to deploying habitat	Sacramento Valley
Groundwater regulation	Water-related habitat data and tools	San Joaquin Valley Tulare Basin

TABLE 4.2.5 Summary of wetland water challenges, opportunities and applicable regions.

and flexible water management opportunities across refuge lands that would enable habitat managers to be more responsive to the dynamic needs of migratory birds, as well as adapt to changing landscapes and climate.

Water-related habitat data and tools

New science is providing more information and tools to inform dynamic and real-time management of water supplies. This field of study, which relies on remote sensing techniques and new interfaces, can allow refuge and system managers to better understand where on the landscape water is present at any given time and pair that information with bird presence and numbers to tailor bird habitat based on current need. This type of real-time, dynamic management promises to allow managers to use water more strategically.

Gauging habitat availability in real time

CVJV partners are developing tools to help habitat managers understand how much habitat is available in the Central Valley at a given time, and new approaches to address habitat shortfalls when and where they occur in the Valley. One example is a system called “Water Tracker”, launched in 2017 by Point Blue Conservation Science to assess the extent of Central Valley open surface water, a surrogate for habitat availability, in near real-time using remote sensing technology. (See Water Tracker box for more information.)

Robust wetland water budget estimates

Implementation of SGMA could affect wetland water availability. Some CVJV organizations are engaging in the development of groundwater policy, science, and project implementation to ensure that the needs of migratory birds are met alongside new requirements to sustainably manage groundwater. For example, some CVJV partners are working with consultants to develop more robust wetland water budget estimates, including broadly applicable methods and tools, with the objective of enabling managed wetlands to fully participate or to have water use and recharge contributions be reflected in groundwater sustainability plans. These tools, along with more robust estimates of wetland evapotranspiration or consumptive use, may also help wetland managers be more targeted and efficient in managing available water supplies and uses, both on the individual wetland scale and across multiple wetland units or refuges.

A variety of approaches to deploying habitat

The CVJV recognizes that a variety of wetland types contribute to the mosaic of habitat that waterfowl, shorebirds, and other wetland-dependent wildlife rely on each year. Each wetland type requires different water management, both in terms of the overall volume of water that must be applied and timing of delivery. The exact composition of the habitat mosaic may change from year to year, but the overall objective is to ensure enough water is available for each wetland type when and where needed. With California’s unpredictable, fluctuating hydrology and changing socioeconomic and cultural factors, flexibility may be the key to provisioning adequate wetland habitat over time.

Acquiring new, permanent easement lands and working with farmers to compatibly manage their land and water favorably for birds are two strategies that Migratory Bird Joint Ventures have used repeatedly and successfully to achieve habitat objectives. Easement managers and farmers can ensure water is available to support habitat when necessary as part of their routine management strategy. However, annual and long-term fluctuations in water supply and agricultural

practices can occasionally reduce the amount of habitat that can be provided by these lands. A complimentary strategy is to dynamically and adaptively provision short-term habitat (and water) when and where migratory birds most need it. By incentivizing farmers to modify their activities or apply water for only short periods, additional habitat can be efficiently provided to address occasional critical needs.

Summary and basin applicability

Table 4.2.5 summarizes wetland water challenges, opportunities that may help address each challenge, and the CVJV basin to which each challenge is relevant.

4.3 POLICY

Public policy decisions, whether through federal or state legislation, regulatory agency rules or administrative action, historically have played a significant role in bird conservation efforts in California.

Even before the passage of the implementing legislation for the Migratory Bird Treaty Act in 1918, which established international cooperation for the conservation of migratory birds, federal laws and regulations existed to help conserve bird populations. These include the Lacey Act (1900), prohibiting trade in wildlife, fish and plants illegally taken, possessed, transported or sold, and the Weeks-McLean Act (1913), regulating waterfowl hunting.

The federal Duck Stamp Act was passed in 1934 to acquire lands for waterfowl habitat protection and restoration efforts, while the federal Pittman-Robertson Act was approved in

1937 to create an annual funding source for state fish and wildlife agencies to conduct wildlife conservation projects. California uses these funds for restoration, population monitoring, as well as for operation and maintenance of state Wildlife Areas, relied upon by many migratory waterfowl and other birds.

In 1971, California lawmakers established a California State Duck Stamp to provide a separate state funding source for waterfowl conservation efforts. State lawmakers have also protected critical waterfowl habitat areas, notably in Suisun Marsh through the Suisun Marsh Preservation Act in 1977. State conservation easements critical to conserving waterfowl habitat on private lands were given additional protection from urban growth pressures by the state legislature in 2001 through the passage of Assembly Bill 910 (Wayne) Wildlife Conservation Easements.

The Farm Bill, reauthorized every 5 years, increasingly provides funding for migratory bird conservation nationally and in California. The 1985 Farm Bill was the first to have a



California state capitol building - Wayne Tilcock, California Waterfowl Association

specific title devoted to conservation and to emphasize the importance of soil conservation for reasons other than crop productivity. USDA programs such as the Wetland Reserve Easement (WRE) and Regional Conservation Partnership Program (RCPP) have provided significant conservation benefits for birds in the Central Valley.

The North American Waterfowl Management Plan (NAWMP), originally signed in 1986 and recently updated in 2018, was the genesis for the national Migratory Bird Joint Ventures program (MBJV 2017). The NAWMP is an international treaty signed by the United States, Canada and Mexico to promote international cooperation in the recovery of North American waterfowl populations. In 1989, the North American Wetlands Conservation Act (NAWCA) was passed, in part, to support activities under the NAWMP. The Act is funded at the federal level and requires reauthorization by the U.S. Congress.

The Central Valley Project Improvement Act (CVPIA), passed in 1992, mandated changes in management of the Central Valley Project, particularly for the protection, restoration, and enhancement of fish and wildlife. Title 34 (d) of Public Law 102-575 identifies wetlands as a key component of wildlife protection and enhancement in the Central Valley and specifies actions to improve water supplies in support of the objectives of the CVJV.

What is the CVJV's Role in Public Policy?

The CVJV partners focus on policy issues that affect the habitat goals and objectives of its Implementation Plan on both public and private lands. During regular board meetings and committee meetings, the CVJV leverages its diverse membership by discussing and sharing information about public policy initiatives that may affect its priorities. The CVJV Management Board sends letters to state and federal agencies and other decision makers to express positions or share information regarding administrative actions that may affect birds and their habitats in the Central Valley. The CVJV partners regularly meet with state and federal agency officials about issues affecting CVJV priorities. When permitted under applicable laws and policies, some CVJV members also lobby the California Legislature and U.S. Congress regarding proposed legislation that would affect CVJV priorities.

CVJV Committees That Address Policy Issues

The CVJV Board maintains a Legislative Affairs Committee that examines state and federal bills, regulations, and policy decisions that affect CVJV interests. The Committee then recommends positions and actions to the CVJV Board on issues with the greatest impact on CVJV habitat goals and objectives. The Legislative Affairs Committee is the primary

committee that works on public policy issues on behalf of the partners.

The Legislative Affairs Committee works closely with the Water Committee, whose members examine a wide range of water policy issues relating to both wetlands and wildlife-friendly agriculture for their effect on CVJV priorities, goals, and objectives, to formulate strategies for water-related policy engagement. Similarly, the Legislative Affairs Committee works with the Lands Committee to consider policy issues that impact bird conservation efforts on both public and private lands. Recommendations by any of the committees must receive approval by the CVJV Board prior to any coordinated action taking place. Actions by partners may include such things as comments on public documents and contact with legislative bodies and policymakers.

Programs and Regulatory Actions That Affect CVJV Habitat Goals and Objectives

The CVJV Management Board (as well as the boards of many of the other Joint Ventures across the United States) is actively engaged on many different public policy issues, particularly those that affect funding for bird habitat conservation efforts. Some important public policy issues are described here.

State and Federal Funding for Bird Habitat Programs

Several key federal and state programs currently help the CVJV fulfill its habitat goals and objectives as identified in this Implementation Plan. Funding for all of these programs is dependent on annual federal or state budget appropriations. In recent decades, the state has relied almost entirely on general obligation bonds to provide funding for state environmental programs.

North American Wetlands Conservation Act (NAWCA)

This U.S. Fish and Wildlife Service (USFWS) program provides grants for wetland conservation projects in the United States, Canada, and Mexico. There is a Standard Grants Program and a Small Grants Program. Both are competitive grant programs and require that grant requests be matched by partner contributions at no less than a 1-to-1 ratio.

Since 1992, there have been more than 120 NAWCA projects either completed or underway in the Central Valley. These projects have conserved over 800,000 acres of wildlife habitat. NAWCA funding of more than \$80 million stimulated partner contributions of more than \$300 million.

Partners for Fish and Wildlife (PFW)

This program is the U.S. Fish and Wildlife Service's habitat restoration cost-sharing program for private landowners. The program was established to provide technical and financial assistance to conservation-minded farmers, ranchers and other private (non-federal and non-state) landowners who wish to restore fish and wildlife habitat on their land. The PFW program emphasizes the restoration of historical ecological communities for the benefit of native fish and wildlife in conjunction with the desires of private landowners.

The Agricultural Conservation Easement Program (ACEP)

This USDA Natural Resources Conservation Service (NRCS) program provides financial and technical assistance to help

conserve agricultural lands and wetlands and their related benefits. Under the Wetlands Reserve Easements component, NRCS helps to restore, protect and enhance enrolled wetlands on private lands, many of which provide significant buffers adjacent to National Wildlife Refuges.

Regional Conservation Partnership Program (RCP)

This NRCS program encourages conservation partners to work with agricultural producers and private landowners to restore and improve the sustainable use of soil, water, wildlife and related natural resources on regional or watershed scales. RCP participants leverage funding to design, implement and maintain voluntary conservation solutions.

California Waterfowl Habitat Program (Presley Program)

This California Department of Fish and Wildlife (CDFW) program provides economic incentives to private landowners who agree to manage their properties in accordance with a wetland management plan developed cooperatively by CDFW biologists and the participating landowner.

CDFW started the program with an original enrollment of 6,500 acres in the Sacramento Valley and San Joaquin Valley. Since that time, the Presley Program has steadily grown to include over 29,000 acres of habitat for wintering and breeding waterfowl in the Central Valley, including the Tulare Basin, Grasslands Ecological Area, Suisun Marsh, and numerous locations in the Sacramento Valley.

California Winter Rice Incentive Program

The purpose of this program is to incentivize the flooding of rice fields after harvest. The practice has a variety of benefits, including air quality, waterfowl habitat, and the production of invertebrates that provide nutrients for out-migrating salmon smolts.

Permanent Wetland Easement Program

This program, administered by the CDFW in cooperation with the Wildlife Conservation Board's Inland Wetland Conservation Program, pays willing landowners approximately 50 to 70 percent of their property's fair market value to purchase the farming and development rights in perpetuity. The landowner retains many rights including trespass rights, the right to hunt and/or operate a waterfowl hunting club and the ability to pursue other types of undeveloped recreation (e.g., fishing, hiking). Easement landowners are required to follow a cooperatively developed wetland management plan and meet bi-annually with CDFW biologists to discuss habitat conditions and management.

Landowner Incentive Program (LIP)

This CDFW program is funded by the USFWS Wildlife and Sport Fish Restoration Program and is an effort to reverse the decline of at-risk species in the Central Valley through enhancement and management of private lands. LIP focuses on the Central Valley's three predominant historical habitat types: wetlands, native grasslands, and riparian habitats. LIP assists landowners with enhancing these three habitat types by providing annual incentive payments in return for implementing habitat management plans that benefit special status species.

Shared Habitat Alliance for Recreational Enhancement (SHARE) Program

CDFW administers the SHARE Program to provide financial incentives to landowners to open their property to the public for hunting and other wildlife-dependent recreation. These types of land uses support bird habitat conservation. The program helps to recruit and retain hunters, including waterfowl and upland game bird hunters, by providing additional low-cost but high-quality opportunities. In surveys, members of the public frequently cite a lack of access to land as a prime reason why they no longer hunt or hunt less often.

The 2018 North American Waterfowl Management Plan, which helps guide waterfowl management efforts in the United States, Canada and Mexico, calls for greater recruitment and retention of waterfowl hunters.

Nesting Bird Habitat Incentive Program

This landowner incentive program in the Fish and Game Code, administered by CDFW, focuses on establishing upland nest cover for waterfowl, other gamebirds and songbirds. For implementation, this program needs start-up and annual funding sources. The program pays farmers and other landowners to maintain vegetative cover on fallowed lands. Priority is given to lands adjacent to waterfowl brood water, such as flooded rice or semi-permanent wetlands on national wildlife refuges and state wildlife areas.

Wildlife Conservation Board – Inland Wetlands Conservation Program (IWCP)

The Inland Wetlands Conservation Program was created in 1990 to assist the CVJV in its mission to protect, restore and enhance wetlands and associated habitats. The IWCP has a wide range of options to accomplish CVJV goals relating to wintering waterfowl, breeding waterfowl, non-breeding shorebirds, breeding shorebirds, waterbirds, and breeding riparian songbirds. Options include acquisitions of land or water for wetlands or wildlife-friendly agriculture, acquisition of conservation easements, restoration of public or

private lands, or enhancement of existing degraded habitats. In addition, the program works toward providing long-term reliable water for wetlands and winter-flooded agricultural lands. The IWCP jurisdiction matches that of the CVJV and includes most of the watershed of the Central Valley.

Wildlife Conservation Board – California Riparian Habitat Conservation Program (CRHCP)

The California Riparian Habitat Conservation Program (CRHCP) was created to protect, preserve and restore riparian habitat throughout California. The CRHCP has a wide range of options to accomplish CVJV goals relating to waterfowl and breeding riparian songbirds. Options include acquisition of land for riparian habitat and floodplains, acquisition of conservation easements, protection of riparian habitat from agricultural land uses, restoration of public or private lands, or enhancement of existing degraded habitats. In addition, the program requires long-term management plans for habitat types protected, restored or enhanced under the CRHCP. The CRHCP jurisdiction overlaps that of the CVJV and includes the watersheds of the Central Valley.

The State Duck Stamp, Upland Game Bird Stamp and related bird hunting validations

The California State Duck Stamp was created by legislation in 1971 (Fish and Game Code §3702) and the Upland Game Bird Stamp was created by legislation in 1992 (Fish and Game Code §3682.1). Licensed hunters are required to purchase state duck and upland gamebird validations when hunting waterfowl and upland game birds. Stamp collectors and conservationists can also purchase the state duck and upland game bird stamps. Revenue from the sale of these items generates significant funding for bird conservation projects in California and is a traditional source of funding for CDFW. In 2018, duck stamp sales generated \$1.25 million and upland game bird stamp sales generated \$1.4 million (CDFW 2019).

The Federal Duck Stamp

Waterfowl hunters are required to purchase federal duck stamps every year with their hunting license; other outdoor recreationists can also buy the collectible federal stamps to support waterfowl habitat conservation. Revenue from this program is used to acquire and protect wetland habitat and purchase conservation easements for the National Wildlife Refuge System. In the Central Valley, these funds have been instrumental in purchasing refuge lands and for establishing conservation easements on private wetlands adjacent to refuges.

The Federal Aid in Wildlife Restoration Act of 1937 (Pittman-Robertson Act)

This Act generates funds from an excise tax on sporting firearms, pistols, ammunition, and bows and arrows. The funds are distributed to state fish and wildlife agencies based on the geographic area of the state and its population of license-buying hunters. In 2018, CDFW was apportioned more than \$26 million in Pittman-Robertson grant funds (USFWS 2018), much of which was used to establish and manage state wildlife areas that are operated for waterfowl and other wildlife conservation, hunting, and compatible public access.

Hunting Licenses

California hunting license revenue is used by CDFW for a variety of conservation purposes, most notably for fish and wildlife law enforcement. In 2018, hunting licenses generated about \$11.4 million (CDFW 2019).

State and Federal Water Programs

Effective water management is essential for achieving the CVJV's objectives because most Central Valley wetlands require water deliveries and because wildlife-friendly agricultural lands are a key part of the Central Valley's bird habitat mosaic. There are several state and federal water-related laws, policies, and programs that affect the CVJV's interests, as discussed in the Water subchapter.

Central Valley Project Improvement Act (CVPIA) Restoration Fund

This federal fund is administered by the U.S. Bureau of Reclamation and USFWS using annual appropriations based on the collection of mitigation and restoration fees from Central Valley Project water users. The CVPIA Restoration Fund is used to pay the costs of acquiring and delivering water to 19 identified wetland habitat areas in the Central Valley, including state, federal and private wetlands. The Restoration Fund is also used for water infrastructure and conveyance projects that benefit these wetlands.

Habitat Management Costs, Permitting and Regulations

Active management is required in order to maintain desired habitat conditions and can be costly. These expenses can prove especially problematic for budget-limited state and federal landowners such as CDFW and USFWS. Major regulatory expenses for wetland and other habitat managers include the following:

The Irrigated Lands Regulatory Program (ILRP)

The ILRP is a regulatory program, administered by the State Water Resources Control Board, that prevents non-source

pollution from irrigated lands. It requires irrigators to join "coalitions" that fund the testing and remediation of pollutant discharges from irrigated lands. The ILRP also requires irrigators to report on nitrate and sediment discharges. Because managed wetlands seldom discharge nitrates or sediment, the Central Valley Regional Water Quality Control Board has exempted managed wetlands from these reporting requirements, thanks to the efforts of CVJV members.

Dredge and Fill Procedures

The State Water Resources Control Board has adopted dredge and fill procedures that apply to waters of the state. With respect to Environmental Restoration and Enhancement Projects (EREP), which include the type of wetland restoration and maintenance projects generally undertaken by CVJV partners, permits may be obtained from regional water quality control boards by presenting funding agreements entered into with state and federal agencies who distribute wetland restoration funding. EREP projects are also exempt from alternatives analysis and compensatory mitigation.

Mosquito Abatement

Spraying or implementing best management practices (BMPs) to control mosquitoes not only constitute a significant wetland management cost in many counties throughout the Central Valley and Suisun Marsh; they also may limit the ecological function and productivity of managed wetlands (Kwasny et al. 2004). These negative ecological impacts can occur through pesticide impacts to the base of the food chain (e.g., invertebrates), which may reduce ecological productivity; habitat manipulation that degrades the quality of wetlands; or delaying or changing the duration of the flooding of wetlands. In addition, many wetland managers have limited operating budgets. More time and money dedicated to mosquito control means fewer resources available for other wetland management activities.

Noxious Weed Control

The spread of invasive non-native plant species can significantly degrade habitats important to waterfowl and other bird species, often requiring annual control efforts (Fredrickson and Taylor 1982). As an example, non-native or undesirable plants such as cocklebur and joint grass in managed wetlands reduce the production of key waterfowl food plants like smartweed and watergrass. Water conveyance systems in managed wetlands are also impeded by the overgrowth of non-native plant species such as water primrose and parrot's feather, requiring expensive and labor-intensive chemical or mechanical control.

SUCCESS STORY

WETLAND HABITAT RESTORATION ON FAITH RANCH

Faith Ranch, in the CVJV's San Joaquin planning region, is a privately-owned property under conservation easement with the USFWS. The easement allows cattle grazing and wildlife-friendly agricultural production while encouraging habitat restoration. Wetland restoration on Cacklebur Pond was completed in 2002 and cattle were excluded from the pond. Restoration was conducted with cost-share funding from two CVJV partners, the USFWS through the Partners for Fish and Wildlife Program, and the NRCS through the Wetland Reserve Program. Faith Ranch has received several NAWCA grants administered by the USFWS for its wetland conservation projects.

BEFORE WETLAND RESTORATION EFFORTS BEGAN



Cacklebur Pond in 2001 - Gary Zahm, Faith Ranch

AFTER CATTLE WERE EXCLUDED



The pond in 2002 - Gary Zahm, Faith Ranch

WITH WETLAND VEGETATION RE-GROWING



The pond in 2004 - Gary Zahm, Faith Ranch

4.4 CLIMATE

California's climate conditions are changing, and those changes are predicted to accelerate over the next century. Extreme weather events are likely to significantly affect bird and human communities alike in the Central Valley. These changes could include increasing air temperatures, decreasing water availability, and more frequent floods and droughts, all of which will negatively affect many bird species. For example, a previous study documented that an increase in mean daily temperature caused a decline in nest survival of Central Valley mallards and gadwalls (Ackerman et al. 2011).

These climate-induced stressors will add to the already-significant existing threats to bird populations and, in many cases, are likely to become the most significant factors influencing bird populations in the Central Valley. Hence, there is an urgent need for natural resource managers to incorporate projected changes in climate patterns into conservation planning efforts to provide for bird populations in a changing future. Managers must consider how these patterns could affect the environment of the Central Valley, how human populations might respond to those changes, and what impact these combined factors could have on bird populations.

This subchapter describes the major changes in climate projected to occur over the next century in the Central Valley and summarizes the vulnerability of the region's bird populations to a shifting climate.



(1) Flooding in the Yolo Bypass - Daniel Nysten, American Rivers (2) Least Bell's vireo, a federally endangered species, collecting nesting material - Robert A. Hamilton

Shifting Climate Conditions

Increasing temperatures

Mean annual temperatures in the Central Valley increased by nearly 2°F since the start of the 20th century (Bureau of Reclamation 2016), though mean annual maximum temperatures decreased in the San Joaquin Valley (Rapacciuolo et al. 2014). In California, average temperatures are projected to increase significantly over the next century (Figure 4.4.1). Climate models project average annual temperatures in California to increase by 1.8°F to 5.4°F by mid-century, and by 3.6°F to 9°F by the end of the century (Cayan et al. 2012).

Increasing air temperatures will lead to increasing water temperatures of rivers, reservoirs, and ephemeral or vernal pools (Bureau of Reclamation 2016).

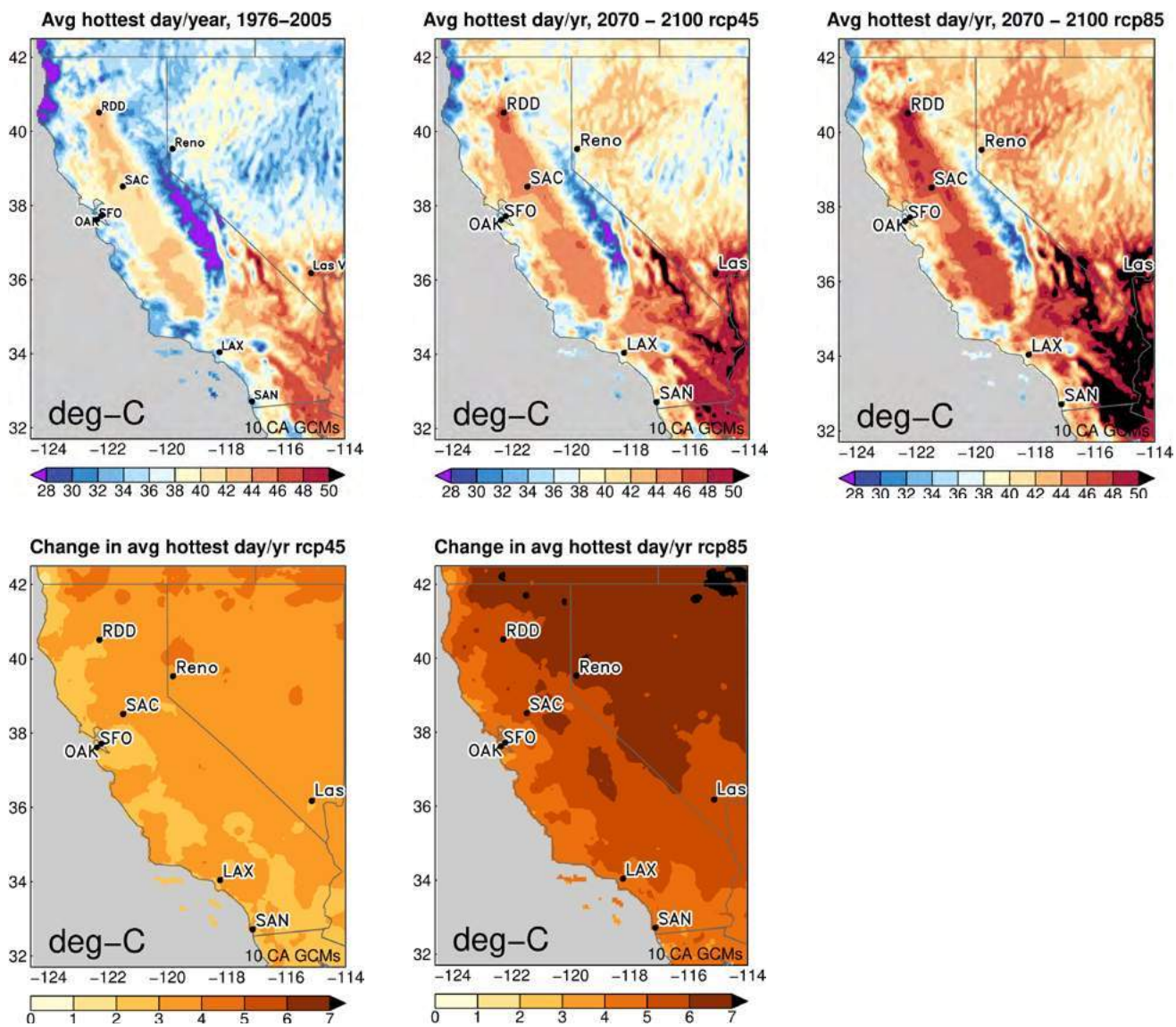

FIGURE 4.4.1 Predicted 21st century temperature increases in California. GCM = Global Circulation Model; RCP = Representative Concentration Pathways. Top row: Average hottest day of the year (°C), averaged over 10 GCMs, for the historical period (top left) and for late-21st century for RCP 4.5 (top middle) and RCP 8.5 (top right) emissions scenarios. Bottom row: the increase (°C) of the late-21st century over the historical values, for RCP 4.5 (bottom center) and RCP 8.5 (bottom right). Results are from the 10 California GCMs (Pierce et al. 2018).

Uncertain changes in average precipitation

Whether the average annual precipitation will increase or decrease in California over the coming century is not clear. Model projections indicate a wide range of potential future changes in precipitation for California and the Central Valley. Despite a drying trend in California since the late 1970s, there is no appreciable trend towards either wetter or drier winters over the full record beginning in 1895 (Funk et al. 2014; Seager et al. 2014). A slight trend toward decreasing and more variable precipitation has been detected in central and southern California over the last 100 years (Hunsaker et al. 2014). The north-south gradient from higher to lower annual precipitation is predicted to continue in the Central Valley (Cayan et al. 2009). Despite this uncertainty, there are other changes expected in the hydrological conditions of the Central Valley as described below.

Decreasing water availability in the dry season

The Central Valley receives most of its annual precipitation during the rainy, cooler season between November and March (Scanlon et al. 2012). During the typically dry months (April – October), the Sierra Nevada snowpack serves as the primary source of water for irrigation and for wetland management (Domagalski et al. 2000; Scanlon et al. 2012). However, the availability of this source of water during the dry season is projected to change. Despite the uncertainty in projections of average annual precipitation, there is relatively high confidence that overall landscape aridity will increase with warmer temperatures (Flint et al. 2013). In short, the dry season will become drier. Several factors will cause this shift, including warmer summer temperatures that will cause drier conditions, warmer winter temperatures that will decrease accumulated snowpack, and warmer winter and spring temperatures that will lead to earlier snowmelt.

The warming trend projected during the dry season will further increase evapotranspiration: evaporation of water from the soil and transpiration of water from plants to the atmosphere. This process will increase the aridity of soils in most areas and will cause drier conditions overall (Cook et al. 2015).

Historically, the Sierra Nevada snowpack has released meltwater gradually, refilling reservoirs, recharging aquifers, and flowing downstream into the Central Valley during the spring and summer. Projections using the best available climate models show that, even during years with an average amount of snowpack in the winter, increasing spring temperatures will cause earlier snowmelt. Warmer temperatures are already leading to earlier spring snowmelt in the Sierra Nevada (Hayhoe et al. 2004; Thorne et al. 2015), changing the timing

of water availability in lowland regions that receive much of their water from snowmelt (Moser et al. 2009; Yarnell et al. 2010; Thorne et al. 2015). With earlier snowmelt, April to July runoff volume has already decreased over the last 100 years by 23 percent and 19 percent in the Sacramento and San Joaquin Basins, respectively (Anderson et al. 2008). The earlier and higher spring peak flows are typically followed by reduced summer flows and longer periods of summer aridity (Yarnell et al. 2010).

In addition, higher peak flows are likely to increase spring flooding risk (Jackson et al. 2011), which requires dam managers to release more stored water from reservoirs earlier in the season to minimize risk of a catastrophic flood (Kiparsky and Gleick 2003; Anderson et al. 2008).

This shift will further constrain water management by hampering the ability to refill reservoirs after the season of highest runoff has passed, thereby reducing the amount of spring runoff that is normally stored. In turn, this will decrease the availability of water for the summer growing season and for postharvest flooding of rice fields to promote stubble decomposition and provide seasonal habitat for birds and other wildlife (Anderson et al. 2008).

Increase in severe storm and flooding events

Climate shifts are likely to increase flooding from severe storms (Swain et al. 2018). Natural formations called “atmospheric rivers” transport huge volumes of condensed water vapor through the atmosphere; these atmospheric rivers can create extreme precipitation. An analysis of climate projections for California indicates that the average intensity of atmospheric river events will not increase. However, there may be more years with many such events and occasionally much stronger events than seen in the historical record. Moreover, the length of the season over which atmospheric river events may occur is predicted to increase. These changing patterns are likely to result in more frequent and more severe floods in California (Dettinger 2011). Hydrological models project larger, more frequent winter floods as rain-on-snow events and winter snowmelt become more common in the headwaters of major river systems in the West (Hamlet and Lettenmaier 2007).

Regardless of variation among specific precipitation projections, all models project that by the end of the century, large discharges from the northern Sierra Nevada that were previously classified as probable only once every 50 years (“50-year floods”) will increase in likelihood by 30 to 90 percent compared to historical values. Corresponding flood flows from the southern Sierra are projected to increase in likeli-

hood by 50 to 100 percent (Das et al. 2013). Overall higher peak flows, caused by earlier and more rapid snowmelt, are likely to increase spring flooding in the Central Valley (Jackson et al. 2011).

Increased frequency and severity of droughts

The combined effect of the changes in the hydrological cycle described above will magnify the impacts of severe droughts in the Central Valley. Compared to the preceding century, drought years in California have occurred twice as often in the last 20 years (Diffenbaugh et al. 2015). Additionally, the 2010–2015 drought was the most severe on record in the Central Valley (Williams et al. 2015), with record high temperatures that worsened its effects. A warming climate is likely to increase the frequency and severity of California droughts (Hayhoe et al. 2004; Cook et al. 2015; Diffenbaugh et al. 2015; Williams et al. 2015; Swain et al. 2018). Severe drought years reduce the open surface water and waterbird habitat in flooded agriculture and managed wetlands across the Central Valley (Reiter et al. 2015; Reiter et al. 2018) and can increase food deficits for waterfowl (Petrie et al. 2016).



Dry seasonal wetland, Yolo Bypass Wildlife Area - Wayne Tilcock, California Waterfowl Association

Effects of a Shifting Climate on Central Valley Bird Populations

General threats

The predominant effects of a shifting climate on bird populations will likely be from changes in water availability. Climate directly determines water availability. Management actions designed to capture and store water for human use indirectly affect it; these management actions are likely to change as climate-related water stressors increase. At particular risk are species sensitive to the timing, amount, and reliability of water. For example, some bird species have come to rely on certain types of agriculture. These species may be affected if management reduces the extent of wetlands and key agricultural crops (rice, corn, alfalfa, irrigated pasture) used by these birds (PRBO Conservation Science 2011).

Estuarine habitats in the Sacramento-San Joaquin Delta are likely to be degraded because of sea level rise and increasing salinity, but the degree of this loss is not yet well understood (PRBO Conservation Science 2011; Achete et al. 2017).

High temperature events, which are predicted to become more common in summer, are likely to result in thermal stress for species with a narrow range of temperature tolerance (e.g., Ackerman et al. 2011; PRBO Conservation Science 2011).

Vulnerability

Evaluations by Gardali et al. (2012) and Galbraith et al. (2014) of the vulnerability of various species of birds to a shifting climate are relevant to bird populations in California's Central Valley.

Gardali et al. (2012) ranked a subset of the state's birds for vulnerability in California. Of the 358 taxa (species, subspecies, and distinct populations) ranked, 230 were not considered vulnerable. The remaining 128 were considered climate-vulnerable and were ranked for three categories of priority: low (80), moderate (35), and high (13). Of these 128 taxa, 31 pertain to the Central Valley (Table 4.4.1). In general, birds associated with wetlands had the largest representation on the list relative to other habitat groups, a pattern that also appears to hold for the Central Valley.

Combined effects of climate and other human stressors

Shifting climate conditions are not the sole determinant of how Central Valley bird populations will fare in the future. Human choices will be important in driving bird population responses to a shifting climate.

Jongsomjit et al. (2013) compared projected spatial impacts of shifting climate patterns and housing development on breeding birds in California. Areas of decreasing climatic suitability for birds and increasing housing density were largely concentrated within the Central Valley. This work suggests that the cumulative effects of future housing development and shifting climate patterns will be significant for many bird species, and that some species otherwise projected to expand their distribution may actually lose ground to development.

Matchett and Fleskes (2017) examined 17 future scenarios for characterizing potential interactions among land use (especially urbanization), water supply management, and shifts in climate conditions with their collective impacts on waterbird habitat. Specifically, they looked at the capacity for the Central Valley to provide additional wetlands to offset modeled impacts of a shifting climate on waterbirds. Most scenarios examined pointed to a loss of options for adequately conserving wetland-dependent birds through wetland restoration after 2065.

The combined impacts of higher temperatures, lower water availability, extreme weather events, and the responses of human populations to these stressors are likely to dramatically impact bird populations in the Central Valley over the next century. It is critically important for natural resource managers to consider these impacts as they develop and enact plans for bird population and habitat conservation.

BIRD SPECIES ORGANIZED BY CLIMATE PRIORITY	CONSERVATION STATUS ^a
High priority	
Yellow rail (winter) (<i>Coturnicops noveboracensis</i>)	BCC, BSSC
California black rail (<i>Laterallus jamaicensis coturniculus</i>)	BCC, ST
Suisun song sparrow (<i>Melospiza melodia maxillaris</i>)	BCC, BSSC
Moderate priority	
Snowy plover (interior population) (<i>Charadrius nivosus</i>)	BCC, BSSC
Black tern (<i>Chlidonias niger</i>)	BSSC
American white pelican (<i>Pelecanus erythrorhynchos</i>)	BSSC
Swainson's hawk (<i>Buteo swainsoni</i>)	ST
Yellow-billed cuckoo (western distinct population segment) (<i>Coccyzus americanus</i>)	FT, SE
Least Bell's vireo (<i>Vireo bellii pusillus</i>)	FE, SE
San Joaquin LeConte's thrasher (<i>Toxostoma lecontei macmillanorum</i>)	BCC, BSSC
Song sparrow (Modesto population) (<i>Melospiza melodia mailliardi</i>)	BSSC-
Lower priority	
Bufflehead (<i>Bucephala albeola</i>)	-
Eared grebe (<i>Podiceps nigricollis</i>)	-
Western grebe (<i>Aechmophorus occidentalis</i>)	BCC
Clark's grebe (<i>Aechmophorus clarkii</i>)	-
Whimbrel (<i>Numenius phaeopus</i>)	BCC
Wilson's phalarope (<i>Phalaropus tricolor</i>)	-
Red-necked phalarope (<i>Phalaropus lobatus</i>)	-
Caspian tern (<i>Hydroprogne caspia</i>)	BCC
Forster's tern (<i>Sterna forsteri</i>)	-

Double-crested cormorant (<i>Phalacrocorax auritus</i>)	-
American bittern (<i>Botaurus lentiginosus</i>)	-
Least bittern (<i>Ixobrychus exilis</i>)	BCC, BSSC
White-faced ibis (<i>Plegadis chihi</i>)	-
Osprey (<i>Pandion haliaetus</i>)	-
Greater roadrunner (<i>Geococcyx californianus</i>)	-
Lesser nighthawk (<i>Chordeiles acutipennis</i>)	-
Rufous hummingbird (<i>Selasphorus rufus</i>)	-
Belted kingfisher (<i>Megaceryle alcyon</i>)	-
Yellow-billed magpie (<i>Pica nuttalli</i>)	BCC
Bank swallow (<i>Riparia riparia</i>)	ST

^a Conservation Status designations: **FE**, federally endangered species; **FT**, federally threatened species; **BCC**, U.S. Fish and Wildlife's Birds of Conservation Concern (USFWS 2008); **SE**, state endangered species; **ST**, state threatened species; **BSSC**, California Bird Species of Concern (Shuford 2008).

TABLE 4.4.1 Conservation status of Central Valley bird taxa classified as vulnerable to the impacts of a shifting climate. These species, subspecies, and distinct populations of birds occur regularly in the Central Valley Joint Venture's Primary Focus Area or Secondary Focus Area up to 3,000 feet elevation (adapted from Gardali et al. 2012).

Galbraith et al. (2014) assessed all North American shorebirds for vulnerability to changes in climate conditions using life history factors such as migration distance and specialized habitat requirements. They ranked the whimbrel (*Numenius phaeopus*) and the long-billed curlew (*N. americanus*) as critically vulnerable. Other highly climate-vulnerable shorebird species were the mountain plover (*Charadrius montanus*), dowitcher species (*Limnodromus* spp.), western sandpiper (*Calidris mauri*), dunlin (*C. alpina*), and Wilson's phalarope (*Phalaropus tricolor*). Each of these shorebird species relies on Central Valley habitat during migration or winter, but the most intense climate-related stressors for these species may occur outside the Central Valley.

4.5 MULTIPLE-BENEFIT PROJECTS

One proven approach to supporting many of the Central Valley Joint Venture’s conservation objectives is to implement intentionally designed “multiple-benefit” projects. Much of California uses the term “multi-benefit” specifically in the context of flood protection projects. In this Implementation Plan (hereafter, “the Plan”), multiple-benefit projects are defined as land use projects designed to meet public safety needs, enhance ecological function, and improve habitat quality for fish and wildlife. Multi-benefit projects can provide benefits such as groundwater recharge, improved water quality, and enhanced access to recreation. Such projects in the Central Valley can combine bird conservation with flood protection, food production, water quality control, groundwater recharge and/or recreational opportunities.

Multiple-benefit projects break away from traditional single-focus management decision-making to use resources efficiently in pursuing multiple compatible public policy objectives. The concept is not new, though the terminology is not always consistent. The terms multi-functionality and co-benefits are often used to capture the same idea (Fisher et al. 2011; Sayer et al. 2013). These approaches are especially critical when land and water are limited resources. They provide a broad suite of benefits to a diverse coalition of stakeholders (Postel 2000; Chan et al. 2006).

The habitat objectives set forth in this Plan are ambitious; thus, funding project implementation will be challenging. By pursuing a strategy of implementing multiple-benefit projects, the CVJV can align the Plan’s conservation goals for migratory birds with the needs of California residents in a manner that leverages investments to create added value to conservation projects. This approach is increasingly essential as the demand for and value of land and water in California continues to increase, making conservation projects more costly. A holistic approach to natural resources conservation enables the CVJV to achieve security for future migratory bird populations and their habitats, while also improving ecosystem functionality in a way that benefits people directly.

For multiple-benefit projects to be successful, they should incorporate the following elements:

1. **SMART (Specific, Measurable, Achievable, Relevant, and Time-bound) objectives** (Doran 1981), reflecting the contribution of a project to multiple planning goals within a region. The CVJV objectives for bird populations and habitats provide an excellent tie-in to existing SMART multiple-benefit objectives for water management in the Central Valley.

2. **Engaged stakeholders cooperating in implementation.** For example, cooperation between rice producers and natural resource managers has resulted in management practices that meet both an agricultural need for postharvest straw decomposition and a wildlife need for surrogate wetlands to support migratory birds.

3. **Shared financing that leverages multiple sources of funding.** For example, pooling funds for levee reinforcement projects for flood protection with conservation easement purchases for riparian restoration can bring ambitious projects within reach. Shared funding can facilitate multiple-benefit conservation projects, at scale, by incorporating setback levees and riparian restoration at the same site and at the same time.

4. **Reduced need for mitigation through improvements in ecological conditions.** A multiple-benefit project can enhance the value of habitat in such a way that it largely offsets or even eliminates the need to mitigate for any environmental degradation caused by the project. For example, a flood-protection setback levee could create benefits for listed salmon.

Policies that may affect development and implementation of multiple-benefit projects are certain to evolve over the lifetime of the Implementation Plan. The CVJV must remain actively engaged in the development of policies and broad programs, not just when planning specific projects. This stance will provide for more opportunities to advocate for a multiple-benefit approach. For example, when the California Air Resources Board was considering greenhouse gas reduction measures for agriculture that included incentives not to flood rice fields during the winter, CVJV partners participated in discussions to inform the conversation. Those incentives would have been detrimental to the large populations of shorebirds and waterfowl that use postharvest-flooded rice fields for food during the non-breeding seasons. The board eventually decided not to adopt the incentives.

Today, there are a number of ongoing planning and restoration efforts that could be transformed into multiple-benefit projects. The following list is not exhaustive, but illustrates some possible opportunities.

Central Valley Flood Management

The spatial footprint of the Central Valley's flood management system overlaps with many of the best areas for providing habitat for waterfowl, shorebirds, waterbirds, and riparian landbirds. Already, the Central Valley Flood Protection Plan developed by the California Department of Water Resources (DWR) has used the CVJV habitat objectives to develop targets for riparian and wetland restoration within floodways. By working with levee districts and DWR, the CVJV can make sure upcoming flood protection projects integrate these habitat restoration targets, such that the projects also contribute to the CVJV's conservation goals (see Hamilton City text box).

Conservation of Other Species and Ecosystems

The Central Valley is not only important for migratory birds; it is also the focal point of significant efforts to recover populations of endangered fish, ensure the future of many rare plant species, and protect the unique biodiversity of the San Joaquin Desert. For example, in 2009, the San Joaquin River Settlement Act was passed to restore flows and salmon populations to California's longest river, the San Joaquin River. The settlement addresses the needs of native fish and wildlife, Central Valley farmers, anglers and other recreationists, and Central Valley residents. The settlement has two goals: (1) restoring and maintaining fish populations in the San Joaquin River, and (2) reducing or avoiding adverse water supply impacts to all long-term water contractors who may be affected.

By following the general approach used for San Joaquin River restoration, the CVJV can leverage conservation dollars and the limited land available for wildlife in a way that provides the greatest benefit for entire ecosystems.

Groundwater Management

California's Sustainable Groundwater Management Act of 2014 is leading to changes in how and where groundwater is used. The Act may lead to fallowing some agricultural land and developing projects designed to recharge groundwater. The CVJV may be able to use these fallowed lands to help meet habitat objectives for grassland or riparian birds and, at the same time, participate in the design and implementation of groundwater recharge projects that also provide waterbird habitat.

Multiple-benefit projects provide a mechanism for tackling the CVJV's ambitious goals. Research is needed to evaluate practices for increasing benefits to people and to wildlife as well as for decreasing the necessity or magnitude of trade-offs in delivery of multiple benefits (Liu 2016). The CVJV is uniquely positioned to identify these research needs. Central Valley-focused agencies and non-governmental organizations are developing growing alliances for implementing multiple-benefit projects. The CVJV has an important role to play in identifying and leveraging win-win solutions that result from these projects. Not every planning process will immediately reveal such synergies. Barriers to achieving multiple-benefit projects may continue or arise anew (Antos 2016). However, the CVJV can provide insight to overcoming these barriers. Complex trade-offs may be in play and require careful management, to ensure that a given project does ultimately serve the needs of migratory birds. Such trade-offs make it even more critical that multiple-benefit projects be identified and implemented to achieve the CVJV's goals.

Examples of multiple-benefit projects that successfully combine wildlife conservation and flood protection can be found at a website supported by a coalition of non-governmental organizations working on wildlife protection in the Central Valley, <http://www.multibenefitproject.org/>.

HAMILTON CITY: A BLUEPRINT FOR MULTIPLE-BENEFIT PROJECTS IN CALIFORNIA

Multiple CVJV partners and Reclamation District 2140 are successfully utilizing a non-regulatory approach to construct a new “setback” levee that will provide significant flood risk reduction to the community of Hamilton City, 10 miles west of Chico. The project also includes large-scale restoration of 1,500 acres of native riparian habitat. The project demonstrates multiple benefits supported by the CVJV, including flood risk management, groundwater recharge, conservation of species and their habitats, and opportunities for outdoor recreation.

Hamilton City has long been at risk of flooding from the Sacramento River, with extensive efforts required in multiple years to avoid failure of the 114-year-old levee. After repeated attempts to justify a single-purpose flood risk reduction project, the community took action to develop a cost-effective, multiple-benefit solution that included both economic and environmental benefits.

During the first phase of the project, a new setback levee will be constructed to provide greater flood protection for the community, and the existing “J Levee” (where the gravel road can be seen in the photo) will be removed to reconnect over 500 acres of floodplain to the river. Once this phase is completed, River Partners will restore approximately 770 acres of former agricultural land to high-quality riparian habitat. Levee construction is scheduled for completion in 2020.

The Hamilton City project plays a significant role in meeting the CVJV’s conservation objectives in the Sacramento planning region for reestablishment of habitat for waterbirds, riparian landbirds, and grassland-oak savannah landbirds. This habitat will benefit at-risk bird species contained within this Plan, as well as other wildlife. Importantly, reconnecting the floodplain with the river will support the recovery of endangered salmon. It will also allow the river’s floodwaters to dissipate, protecting nearby orchards.



(1) The Sacramento River above Hamilton City, flowing past the Phase I restoration area/floodplain - River Partners. (2) A white alder awaits planting in the now-complete Phase I restoration area - River Partners



The giant garter snake is listed as a federally- and state-endangered species. The Yolo Bypass Wildlife Area provides habitat for this and other wildlife species, while also providing flood protection and recreation opportunities. *Dave Feliz*



Tule elk, an elk subspecies found only in California, benefit from grassland habitat management in the Central Valley. Hunters, many of whom are active conservationists, benefit in turn. *Dale Garrison*

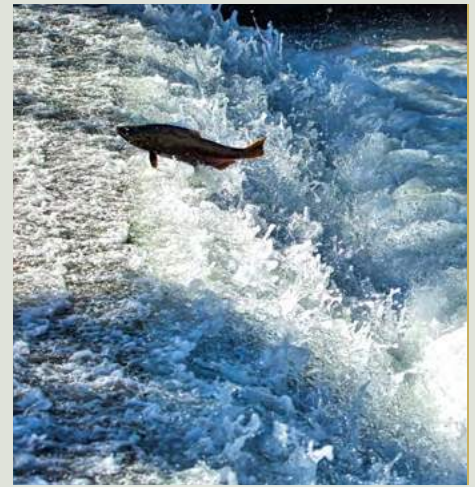

Native salmon and steelhead benefit from intentionally designed multiple-benefit projects such as riparian restoration. *Steve Martarano, USFWS*



Some multiple-benefit projects can provide habitat for federally-listed species such as the valley elderberry longhorn beetle. *Steve Martarano, USFWS*



Boaters and anglers benefit from bird-friendly riparian habitat on the San Joaquin River. *Steve Martarano, USFWS*



Students help restore wetland habitat near Stockton. Multiple-benefit projects can provide opportunities for education and outreach. *Steve Martarano, USFWS*



High water on the Yolo Bypass floodplain. The Yolo Bypass is a successful multiple-benefit project, diverting Sacramento River floodwaters from Sacramento and other population centers while protecting habitat for birds and other wildlife. *Steve Martarano, USFWS*

LITERATURE CITED

4.1 Background

- Baldwin B, Goldman J, Keil D, Patterson R, Rosatti T, Wilken D. 2012. *The Jepson Manual: vascular plants of California*. Second Edition. University of California Press, Berkeley.
- [CPIF] California Partners in Flight. 2000. Version 1.0. The draft grassland bird conservation plan: a strategy for protecting and managing grassland habitats and associated birds in California (B. Allen, lead author). Point Reyes Bird Observatory, Stinson Beach, CA. Available from: <http://www.prbo.org/calpif/>
- [CVBC] Central Valley Bird Club. 2010. Checklist of birds of the Central Valley California. Sterling J, editor. Available from: <http://www.cvbirds.org/wp-content/themes/cvbirds/files/2015-CVBC-Checklist.pdf>
- Dennis NB, Marcus ML, Hill H. 1984. Status and trends of California wetlands. A report to the California Assembly Resources Subcommittee.
- [DGP-GIC] Department of Geography and Planning and Geographical Information Center. 2003. The Central Valley historic mapping project. Chico, CA: California State University.
- DiGaudio RT, Dybala KE, Seavy NE, Gardali T. 2017. Population and habitat objectives for avian conservation in California's Central Valley grassland-oak savannah ecosystems. *San Franc Estuary Watershed Sci.* 15(1): Article 6. Available from <https://escholarship.org/uc/item/0dn9f9b4>
- Fraye WE, Peters DD, Pywell HR. 1989. Wetlands of the California Central Valley: status and trends: 1939 to mid-1980's. U.S. Fish and Wildlife Service, Portland, OR.
- Garone P. 2011. *The fall and rise of the wetlands of California's Great Central Valley*. University of California Press. Berkeley, California.
- [GIC] Geographic Information Center. 2003. The Central Valley historic mapping project. Chico (CA): California State University. Available from: https://www.waterboards.ca.gov/waterrights/water_issues/programs/bay_delta/docs/cmnt081712/sldmwa/csuhicodptofgeographyandplanningcentralvalley.pdf
- Hamilton JG. 1997. Changing perceptions of pre-European grasslands in California. *Madroño* 44(4):311-333.
- McLandress RM, Yarris GS, Perkins AEH, Connelly DP, Raveling DG. 1996. Nesting biology of California mallards. *J Wildl Manag.* 60:94-107.
- Moyle PB, Manfree AD, Fiedler PL. 2014. *Suisun Marsh: Ecological history and possible futures*. University of California Press.
- Petrik K, Fehringer D, Weverko A. 2014. Mapping seasonal managed and semi-permanent wetlands in the Central Valley of California. Final Report to the Central Valley Joint Venture. Ducks Unlimited, Inc.: Rancho Cordova, CA.
- Spencer WD, Beier P, Penrod K, Winters K, Paulman C, Rustigian-Romsos H, Stritholt J, Parisi M, Pettler A. 2010. California essential habitat connectivity project: A strategy for conserving a connected California. Prepared for California Department of Transportation, California Department of Fish and Game, and Federal Highways Administration.
- Suisun Marsh Protection Plan. December 1976. Bay Conservation and Development Commission. Available from: http://www.bcdc.ca.gov/plans/suisun_marsh#2
- Warmer RE, Hendrix KM. 1985. Riparian resources of the Central Valley and California desert. California Department of Fish and Game.

4.2 Water

- [CDWR] California Department of Water Resources. 2019. SGMA Groundwater Management. Available from: <https://water.ca.gov/Programs/Groundwater-Management/SGMA-Groundwater-Management>
- [CRC] California Rice Commission. 2015. Winter-flooding of California rice fields; Benefitting waterbirds and complementing habitat projects in the Central Valley. White paper prepared by Paul Buttner.
- [CVJV] Central Valley Joint Venture. 1990. Central Valley Habitat Joint Venture Implementation Plan. U.S. Fish and Wildlife Service. Sacramento, CA.
- [CVPIA IRP] CVPIA Independent Review Panel. 2009. Undelivered Water: Fulfilling the CVPIA Promise to Central Valley Refuges. Central Valley Project Improvement Act Refuge Water Supply Program. Available at: https://www.usbr.gov/mp/cvpia/docs_reports/indep_review/CVPIA_Final_Refuge_Report_2009-11-03.pdf
- Diffenbaugh NS, Swain DL, Touma D. 2015. Anthropogenic warming has increased drought risk in California. *Proc Natl Acad Sci USA* 112:3931-3936.
- Dybala KE, Reiter ME, Hickey CM, Shuford WD, Strum KM, Yarris GS. 2017. A bioenergetics approach to setting conservation objectives for non-breeding shorebirds in California's Central Valley. *San Franc Estuary Watershed Sci.* 15(1):Article 2. Available from: <https://escholarship.org/uc/item/1pd2q7sx>

- Frayer WE, Peters DD, Pywell HR. 1989. Wetlands of the California Central Valley: status and trends. Report to U.S. Fish and Wildlife Service, Portland, Oregon.
- IPCC. 2013. Climate Change 2013: The physical science basis. Contribution of working group I to the fifth assessment report of the intergovernmental panel on climate change. Stocker TF, Qin D, Plattner G-K, Tignor M, Allen SK, Boschung J, Nauels A, Xia Y, Bex V, Midgley PM, editors. Cambridge University Press, Cambridge, United Kingdom and New York, NY, USA.
- Matchett EL, Fleskes JP. 2018. Waterbird habitat in California's Central Valley basins under climate, urbanization, and water management scenarios. *J Fish Wildl Manag.* 9:75–94;e1944-687X.
- Matchett EL, Fleskes JP. 2017. Projected impacts of climate, urbanization, water management, and wetland restoration on waterbird habitat in California's Central Valley. *PLoS ONE* 12:e0169780. doi: 10.1371/journal.pone.0169780
- Miller MR, Garr JD, Coates PS. 2010. Changes in the status of harvested rice fields in the Sacramento Valley, California: Implications for wintering waterfowl. *Wetlands* 30:939-947.
- Naylor LW. 2002. Evaluating moist-soil seed production and management in Central Valley wetlands to determine habitat needs for waterfowl. M.S. Thesis, University of California, Davis. Available from: http://www.centralvalleyjointventure.org/assets/pdf/Naylor_Final_Thesis.pdf
- [NRCS et al. 2007] Natural Resources Conservation Service, U.S. Fish and Wildlife Service, Mississippi River Trust. 2007. Wetland Management for Waterfowl Handbook. Available from https://www.nrcs.usda.gov/Internet/FSE_DOCUMENTS/nrcs142p2_016986.pdf
- Petrie MJ, Fleskes JP, Wolder MA, Isola CR, Yarris GS, Skalos DA. 2016. Potential effects of drought on carrying capacity for wintering waterfowl in the Central Valley of California. *J Fish Wildl Manag.* 7:408–422. doi: 10.3996/082015-JFWM-082
- Petrie MJ, Petrik K. 2017. Assessing waterfowl benefits from water used to grow rice in California. Prepared by Ducks Unlimited for the California Rice Commission.
- Reiter ME, Elliott N, Jongsomjit D, Golet G, Reynolds MD. 2018. Impact of extreme drought and incentive programs on flooded agriculture and wetlands in California's Central Valley. *PeerJ* 6:e5147. doi: 10.7717/peerj.5147
- Reiter ME, Elliott N, Veloz S, Jongsomjit D, Hickey CM, Merryfield M, Reynolds MD. 2018. Spatio-temporal patterns of open surface water in the Central Valley of California 2000-2011: Drought, land cover, and waterbirds. *JAWRA*. doi: 10.1111/1752-1688.12353
- [UC Davis] University of California, Davis, Agronomy Research & Information Center. 2019. Water Use by Rice. Available from: http://rice.ucanr.edu/Water_Use_by_Rice/
- [USBR] U.S. Bureau of Reclamation. 1989. Report on refuge water supply investigations. Central Valley Hydrologic Basin, California. Sacramento, CA.
- [USBR] U.S. Bureau of Reclamation. 1986. Central Valley fish and wildlife management study: Refuge water supply, Central Valley hydrologic basin, California. Sacramento, CA.
- [USBR and USFWS] U.S. Bureau of Reclamation, U.S. Fish and Wildlife Service. 2004. Implementation of the Central Valley Project Improvement Act; Annual report for fiscal year 2003.
- [USBR et al.] U.S. Bureau of Reclamation, U.S. Fish and Wildlife Service, California Department of Fish and Game, and Grasslands Resource Conservation District. 1998. An interagency coordinated program for wetland water use planning: Central Valley, California. Sacramento, CA.
- [USBR et al.] U.S. Bureau of Reclamation, U.S. Fish and Wildlife Service, and California Department of Fish and Game. 1989. San Joaquin Basin action plan/Kesterson mitigation action plan report: Merced County, California. Sacramento, CA.
- [USFWS] U.S. Fish and Wildlife Service. 2000. Central Valley wetlands water supply investigations. CVPIA 3406 (d) (6) (A, B). A Report to Congress. Final Report. December 2000.

4.3 Policy

- [CDFW] California Department of Fish and Wildlife. 2019. Hunting revenue reported by license year. Available from: <https://nrm.dfg.ca.gov/FileHandler.ashx?DocumentID=59822&inline>
- Fredrickson LH, Taylor TS. 1982. Management of seasonally flooded impoundments for wildlife. U. S. Fish and Wildlife Service Resource Publication 148. Available from: https://www.fwspubs.org/doi/suppl/10.3996/012014-JFWM-009/suppl_file/012014-jfwm-009.s2.pdf
- Kwasny DC, Wolder M, Isola CR. 2004. Technical guide to best management practices for mosquito control in managed wetlands. Central Valley Joint Venture. Available from: <http://www.centralvalleyjointventure.org/assets/pdf/CVJV-Mosquito-BMP.pdf>

[MBJV] Migratory Bird Joint Ventures. 2017. Who we are. Available from: <https://mbjv.org/who-we-are/>

[USFWS] U.S. Fish & Wildlife Service. 2018. Wildlife Restoration Program – funding. Wildlife & Sport Fish Restoration Program. Available from: <https://wsfrprograms.fws.gov/subpages/grantprograms/WR/WRFinalApportionment2018.pdf>

4.4 Climate

Achete F, van der Wegen M, Roelvink JA, Jaffe B. 2017. How can climate change and engineered water conveyance affect sediment dynamics in the San Francisco Bay-Delta system? *Clim Change* 142:375. doi: 10.1007/s10584-017-1954-8

Ackerman JT, Herzog MP, Salas L, Gardali T, Ballard G, Loughman D, Yarris G, Eadie JM. 2011. Avian breeding demographic response to climate change: A multi-species and multi-landscape approach to synthesizing risk factors. Summary Report, U.S. Geological Survey, Western Ecological Research Center, Davis, CA; PRBO Conservation Science, Petaluma, CA; California Waterfowl Association, Sacramento, CA; University of California, Davis, CA. 133 pp. Available from: http://climate.calcommons.org/sites/default/files/Avian%20Demographics%20LCC_FinalReport_V13.pdf

Anderson J, Chung F, Anderson M, Brekke L, Easton D, Ejeta M, Peterson R, Snyder R. 2008. Progress on incorporating climate change into management of California's water resources. *Clim Change* 87:91–108.

Bureau of Reclamation. 2016. Chapter 8: Sacramento and San Joaquin river basins. In: SECURE Water Act Section 9503(c) – Reclamation climate change and water. Prepared for U.S. Congress. Denver, CO: Bureau of Reclamation, Policy and Administration.

Cayan D, Tyree M, Dettinger D, Hidalgo H, Das T, Maurer E, Bromirski P, Graham N, Flick R. 2009. Climate change scenarios and sea level rise estimates for the California 2008 climate change scenarios assessment. PIER Research Report CEC- 500-2009-014-F. Sacramento, CA: California Energy Commission, California Climate Change Center. 64 pp. Available from: <http://www.energy.ca.gov/2009publications/CEC-500-2009-014/CEC-500-2009-014-F.PDF>

Cayan D, Tyree M, Pierce D, Das T. 2012. Climate change and sea level rise scenarios for California vulnerability and adaptation assessment. California Energy Commission. Publication number: CEC-500-2012-008.

Cook BI, Ault TR, Smerdon JE. 2015. Unprecedented 21st century drought risk in the American Southwest and Central Plains. *Sci Adv.* 1:e1400082.

Das T, Maurer EP, Pierce DW, Dettinger MD, Cayan DR. 2013. Increases in flood magnitudes in California under warming climates. *J Hydrol.* 501:101–110.

Dettinger M. 2011. Climate change, atmospheric rivers, and floods in California – a multimodel analysis of storm frequency and magnitude changes. *J Am Water Resour Assoc.* 47:514–523.

Diffenbaugh NS, Swain DL, Touma D. 2015. Anthropogenic warming has increased drought risk in California. *Proc Natl Acad Sci.* 112:3931–3936.

Domagalski JL, Knifong DL, Dileanis PD, Brown LR, May JT, Connor V, Alpers CN. 2000. Water quality in the Sacramento River Basin, California, 1994–98. Page 36. U.S. Geological Survey, Sacramento, CA.

Flint LE, Flint AL, Thorne JH, Boynton R. 2013. Fine-scale hydrologic modeling for regional landscape applications: The California Basin Characterization Model development and performance. *Ecol Process.* 2:article 25. doi: 10.1186/2192-1709-2-25

Funk C, Hoell A, Stone D. 2014. Examining the contribution of the observed global warming trend to the California droughts of 2012/13 and 2013/14, in *Explaining extreme events of 2013 from a climate perspective* (S. C. Herring, M. P. Hoerling, T. C. Peterson, and P. A. Stott, eds.). *Bull Am Meteorol Soc.* 95(9):S11–S15.

Galbraith H, DesRochers DW, Brown S, Reed JM. 2014. Predicting vulnerabilities of North American shorebirds to climate change. *PLoS ONE* 9:e108899.

Gardali T, Seavy NE, DiGaudio RT, Comrack LA. 2012. A climate change vulnerability assessment of California's at-risk birds. *PLoS ONE* 7:e29507.

Hamlet AF, Lettenmaier DP. 2007. Effects of 20th century warming and climate variability on flood risk in the western U.S. *Water Resour Res.* 43(6):W06427.

Hayhoe K, Cayan DR, Field CB, Frumhoff PC, Maurer EP, Miller NL, Moser SC, Schneider SH, Nicholas K, Cleland EE, et al. 2004. Emissions pathways, climate change, and impacts on California. *Proc Natl Acad Sci.* 101:12422–12427.

Hunsaker CT, Long JW, Herbst DB. 2014. Watershed and stream ecosystems. In: Long, JW, Quinn-Davidson L, Skinner CN, eds. *Science synthesis to support socioecological resilience in the Sierra Nevada and southern Cascade Range*. Gen Tech Rep PSW-GTR-247. Albany, CA: U.S. Department of Agriculture, Forest Service, Pacific Southwest Research Station: p 265–322.

Jackson LE, Wheeler SM, Hollander AD, O'Geen AT, Orlove BS, Six J, Sumner DA, Santos-Martin F, Kramer JB,

- Horwath WR, et al. 2011. Case study on potential agricultural responses to climate change in a California landscape. *Clim Change* 109:407–427.
- Jongsomjit D, Stralberg D, Gardali T, Salas L, Wiens J. 2013. Between a rock and a hard place: The impacts of climate change and housing development on breeding birds in California. *Landscape Ecol.* 28(2):187–200.
- Kiparsky, M, Gleick PH. 2003. Climate change and California water resources: A survey and summary of the literature. Pacific Institute for Studies in Development, Environment, and Security, Oakland, CA.
- Kueppers LM, Snyder MA, Sloan LC, Zavaleta ES, Fulfrost B. 2005. Modeled regional climate change and California endemic oak ranges. *Proc Natl Acad Sci USA* 102:16281–16286.
- Matchett EL, Fleskes JP. 2017. Projected impacts of climate, urbanization, water management, and wetland restoration on waterbird habitat in California's Central Valley. *PLoS ONE* 12:e0169780. doi: 10.1371/journal.pone.0169780
- Moser S, Franco G, Pittiglio S, Chou W, Cayan D. 2009. The future is now: An update on climate change science impacts and response options for California. California Energy Commission, PIER Energy-Related Environmental Research.
- Petrie MJ, Fleskes JP, Wolder MA, Isola CR, Yarris GS, Skalos DA. 2016. Potential Effects of Drought on Carrying Capacity for Wintering Waterfowl in the Central Valley of California. *J Fish Wildl Manag.* 7:408-422.
- Pierce DW, Kalansky JF, Cayan DR, (Scripps Institution of Oceanography). 2018. Climate, Drought, and Sea Level Rise Scenarios for the Fourth California Climate Assessment. California's Fourth Climate Change Assessment, California Energy Commission. Publication number: CNRA-CEC-2018-006.
- PRBO Conservation Science. 2011. Projected effects of climate change in California: Ecoregional summaries emphasizing consequences for wildlife. Version 1.0. Available from: <http://data.prbo.org/apps/bssc/climatechange>
- Rapacciuolo G, Maher SP, Schneider AC, Hammond TT, Jabis MD, Walsh RE, Iknayan KJ, Walden GK, Oldfather MF, Ackerly DD, et al. 2014. Beyond a warming fingerprint: Individualistic biogeographic responses to heterogeneous climate change in California. *Global Change Biol.* 20(9):2841–2855.
- Reiter ME, Elliott N, Veloz S, Jongsomjit D, Hickey CM, Merrifield M, Reynolds MD. 2015. Spatio-temporal patterns of open surface water in the Central Valley of California 2000–2011: Drought, Land Cover, and Waterbirds. *J Am Water Resour Assoc.* 54:1722–1738. doi: 10.1111/1752-1688.12353
- Reiter ME, Elliott N, Jongsomjit D, Golet G, Reynolds MD. 2018. Impact of extreme drought and incentive programs on flooded agriculture and wetlands in California's Central Valley. *PeerJ.* 6:e5147. doi: 10.7717/peerj.5147
- Scanlon BR, Faunt CC, Longuevergne L, Reedy RC, Alley WM, McGuire VL, McMahon PB. 2012. Groundwater depletion and sustainability of irrigation in the US High Plains and Central Valley. *Proc Natl Acad Sci.* 109:9320–9325.
- Seager R, Hoerling M, Schubert S, Wang H, Lyon B, Kumar A, Nakamura J, Henderson N. 2014. Causes and predictability of the 2011–14 California drought. Assessment report, NOAA Drought Task Force/National Integrated Drought Information System. Available from: <http://cpo.noaa.gov/MAPP/californiadroughtreport>
- Shuford WD. 2008. Black Tern (*Chlidonias niger*). In: Shuford WD, Gardali, T, editors. California Bird Species of Special Concern: a ranked assessment of species, subspecies, and distinct populations of birds of immediate conservation concern in California. Studies of Western Birds 1. Camarillo (CA): Western Field Ornithologists; and Sacramento (CA): Calif. Dept. Fish and Game. Available from: <http://www.dfg.ca.gov/wildlife/nongame/ssc/birds.html>
- Swain DL, Langenbrunner B, Neelin JD, Hall A. 2018. Increasing precipitation volatility in twenty-first-century California. *Nat Clim Change* 8:427–433.
- Thorne JH, Boynton RM, Flint LE, Flint AL. 2015. The magnitude and spatial patterns of historical and future hydrologic change in California's watersheds. *Ecosphere* 6: 1–30.
- [USFWS] U.S. Fish and Wildlife Service. 2008. Birds of Conservation Concern 2008. Arlington, Virginia: U.S. Department of Interior, Fish and Wildlife Service, Division of Migratory Bird Management. Available from: <https://www.fws.gov/migratorybirds/pdf/grants/BirdsofConservationConcern2008.pdf>
- Williams AP, Seager R, Abatzoglou JT, Cook BI, Smerdon JE, Cook ER. 2015. Contribution of anthropogenic warming to California drought during 2012–2014. *Geophys Res Lett.* 42(16):6819–6828.
- Yarnell SM, Viers JH, Mount JF. 2010. Ecology and management of the spring snowmelt recession. *BioScience* 60:114–127.

4.5 Multiple-Benefit Projects

- Antos M. 2016. Social-ecological and institutional barriers to adaptive water management. Doctoral dissertation. Los Angeles, CA: University of California at Los Angeles. 169 pp. Available from <https://escholarship.org/uc/item/0gt1n048>.
- Chan KM, Shaw MR, Cameron DR, Underwood EC, Daily GC. 2006. Conservation planning for ecosystem services. *PLoS Biol.* 4:e379.
- Doran GT. 1981. There's a S.M.A.R.T. way to write management's goals and objectives. *Management Review.* 70(11):35–36.
- Fisher B, Bradbury RB, Andrews JE, Ausden M, Bentham-Green S, White SM, Gill JA. 2011. Impacts of species-led conservation on ecosystem services of wetlands: understanding co-benefits and tradeoffs. *Biodivers Conserv.* 20:2461–2481.
- Liu Q. 2016. Interlinking climate change with water-energy-food nexus and related ecosystem processes in California case studies. *Ecol Process.* 5:14. Available from <https://doi.org/10.1186/s13717-016-0058-0>.
- Postel SL. 2000. Entering an era of water scarcity: the challenges ahead. *Ecol Appl.* 10:941–948.
- Sayer J, Sunderland T, Ghazoul J, Pfund JL, Sheil D, Meijaard E, Venter M, Boedhihartono AK, Day M, Garcia C, van Oosten C. 2013. Ten principles for a landscape approach to reconciling agriculture, conservation, and other competing land uses. *Proc Natl Acad Sci.* 110:8349–8356.

NOTES

4.2 Water

- Bettner T. 2016. General Manager of Glen-Colusa Irrigation District, discussions with J. Brantigan.
- Hardt D. 2004. Kern National Wildlife Refuge, Refuge Manager, discussions with D. Garrison.
- Petrie M. 2016. Director of Conservation Planning, Ducks Unlimited, Inc., discussions with J. Brantigan.
- [USBR] U.S. Bureau of Reclamation. 1978. Total Water Management Study for the Central Valley Basin of California. Unpublished Report.
- [USBR] U.S. Bureau of Reclamation. 1979. Central Valley Fish and Wildlife Management Study of 1979. Unpublished Report.
- [USBR] U.S. Bureau of Reclamation. 2017. Refuge Water Supply Program staff discussions with J. Brantigan.
- Wehr E, Brantigan J, Garrison D, Manley T. 2017. Flyway water and funding needs. Unpublished Report.
- Wolder M. 2012. Sacramento National Wildlife Refuge biologist, discussions with D. Garrison.

HUMAN DIMENSIONS OF BIRD CONSERVATION IN THE CENTRAL VALLEY



Hiker on Merced Wild and Scenic River - BLM

Studying the human dimensions of natural resource conservation broadens the focus outward from wildlife and habitats to encompass the social and political considerations that influence wildlife and habitat management. Human dimensions is “a field of study that applies the social sciences to examine human-wildlife relationships, and, in doing so, provides information that contributes to effective wildlife conservation efforts” (Manfredo 2008). The field of human dimensions includes many disciplines, including psychology, sociology, anthropology, economics, communications, education, geography, social marketing, recreation and leisure, political science and planning. Because human influence permeates every aspect of conservation, collaboration among disciplines is essential to successful wildlife conservation efforts. This is especially true in the Central Valley, where agriculture and other human land uses encompass the overwhelming majority of the planning area, meaning that human decisions have profound influences on ecological conditions.

Human dimensions can be applied in conservation settings in an adaptive management, or Strategic Habitat Conservation approach, commonly used in the biological sciences. Researchers study what people think and do related to conservation, discern reasons and motivations, incorporate those understandings into policies and programs using best practices for engaging people, and evaluate results. Human dimensions research informs applied work such as education, outreach and communications.

National bird conservation plans now call for more extensive human dimensions research. For example, the 2012 North American Waterfowl Management Plan (NAWMP) Revision (entitled People Conserving Waterfowl and Wetlands; NAWMP 2012) refers to the three-legged stool of conservation as including people, habitat and birds. To implement the NAWMP Revision’s goal of “growing the number of waterfowl hunters, other conservationists, and citizens who enjoy and actively support waterfowl and wetlands conservation,” the NAWMP Plan Committee and the National Flyway Council jointly organized a Human Dimensions Working Group.

This growing interest in human dimensions is largely due to the recognition of three important aspects of bird conservation:

1. The solutions to our conservation challenges require changes in human behavior. For example, to address habitat loss, a goal could be to have more land under conservation easement (an action by landowners) or change land use policy (an action by local planning boards).
2. Conservation is something that is done for, with, and by people. This idea is familiar to government agencies that manage land and wildlife for the public. To serve the public, it is necessary to understand their interests.
3. Science-based decision making for conservation must be informed by both the biological and social sciences. Conservation professionals make numerous decisions based upon their assumptions about what people think and how to influence human behavior. When these decision-makers understand what motivates people, their knowledge, and thus their decisions, are better informed.

The efforts of Migratory Bird Joint Ventures are largely based on the biological sciences. However, multiple opportunities exist to incorporate human dimensions information and approaches into Joint Ventures’ Strategic Habitat Conservation-based work (Figure 5.1; also see: Planning for Conservation Success for more information).

Strategic Habitat Conservation (SHC) & HD

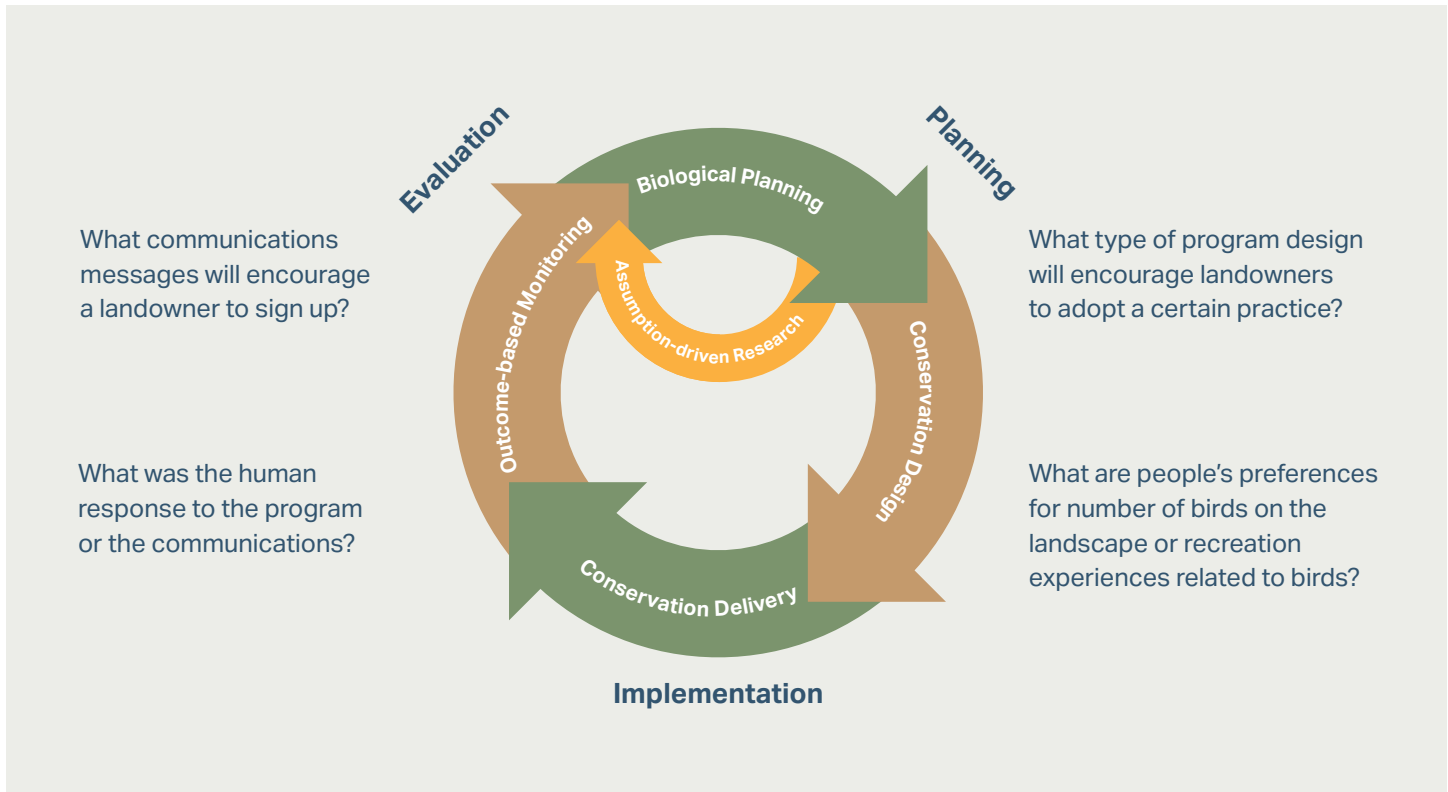

FIGURE 5.1 Strategic Habitat Conservation (SHC) and human dimensions: Human dimensions research can help improve all aspects of the work of a Joint Venture. For example, in the case of private lands conservation, human dimensions research questions are important to consider in every phase of a Joint Venture's work, including biological planning, conservation design, program delivery and monitoring.

PRIORITY HUMAN DIMENSIONS TOPICS IN THE CENTRAL VALLEY

The CVJV identified seven priority human dimensions topics to address, then conducted an extensive literature review on these topics. The literature review (Dayer and Meyers 2016a) and the resulting report (Dayer and Meyers 2016b) are available online at <https://www.centralvalleyjointventure.org/science/2020-implementation-plan>.

The seven priority topics focus on human dimensions aspects of four key stakeholder groups: hunters, farmers, non-hunting recreationists and urban residents; and three key issues: ecosystem services, environmental justice and multiple benefits.

High-priority human dimensions research needs and management recommendations are detailed in the Dayer and Meyers (2016b) report.

HUNTERS:

Waterfowl hunter recruitment, retention and reactivation, and maintaining hunt club ownership of land

Hunters are often active conservationists, and lands owned by waterfowl hunting clubs are typically managed as high-quality wildlife habitat. Hunters also contribute toward conservation financially; for example, in 2017, California hunters and anglers generated more than \$91 million through the sale of hunting and fishing licenses, tags and stamps (CDFW 2018). For these reasons, hunters are an important focus of the CVJV's conservation strategy.

The number of duck hunters in California declined 63 percent from 1971 to 2015 (CDFW 2016). This group is primarily composed of rural residents (75 percent), males (91 percent) and whites (88 percent) (USFWS 2013)– a significantly different demographic profile from the population of the region (see Environmental Justice section). Research shows that increasing urbanization is associated with a value shift away from hunting (Larson et al. 2014). Other contributing factors include hunter success, access to land and harvest regulations (Slagle and Dietsch 2018). Therefore, these declines are likely to continue unless new approaches to hunter recruitment, retention and reactivation (R3) are developed and implemented (CDFW 2019).

According to one recent study (Larson et al. 2014), hunters need quality social habitat to flourish. Three types of social habitat are needed: the micro level (the hunter, their family, hunting friends and hunting mentors); the meso level (community support networks, including extended family and peers, and local access to hunting opportunities); and the macro level (demographic changes, urban areas expansion, habitat fragmentation and agency policies).

A particularly problematic research gap for R3 and hunter support for water-



Waterfowl hunters on a privately-owned wetland - California Waterfowl Association

fowl habitat is the dearth of information about duck hunting clubs in the Central Valley. Hunt clubs have long conserved wildlife habitat, especially for waterfowl. One study identified 351 hunt clubs in California whose management practices have significantly improved wetland protection and restoration (Brown 2008). However, little to no research has been conducted on how to best support these clubs and their members in the face of declining hunter populations and growing costs of maintaining clubs.

The 2016 NAWMP/National Flyway Council's human dimensions survey of waterfowl hunters in California (and nationally) (Slagle and Dietsch 2018) provides valuable information on waterfowl hunters' behaviors, preferences for recreational experiences, conservation behaviors and perceptions

of ecosystem services of wetlands. Further analysis of this information could provide insights on how to maintain and increase hunt club ownership of land, a potentially important strategy to increase waterfowl habitat, and could guide development of the CVJV's targeted communication strategies.

FARMERS:

Beliefs and behavior related to wildlife habitat, and how to engage and support farmers

Farmer beliefs and attitudes related to wildlife habitat can strongly influence their habitat conservation behaviors, such as enrolling in habitat incentive programs to benefit birds. Research shows that prior farmer behavior is the strongest predictor of whether they will conduct a conservation behavior (Sheeder and Lynne 2011; Klöckner 2013; Moses 2013). Many other factors play a role in decisions to create habitat, such as farm size, perceived ability to create habitat, social norms, and length and restrictiveness of contracts (Parkhurst 2011; Sheeder and Lynne 2011; Klöckner 2013; Moses 2013; Canales et al. 2015).

The most consistent and important motivational factors for adopting conservation measures is an ethos or attitude of believing it is important to protect and conserve natural resources and to put social good above profits. Some farmers are willing to continue conservation practices without financial incentives, once they have invested time and money to start them (Dayer et al. 2017). This willingness suggests that carefully designed research and education programs to support continued farm conservation may work in the absence of financial incentives. The extent to which this is the case for farmers in CVJV areas is unknown.

A study that examined different management styles found that farmers may fall into one of three groups (Brodt et al. 2006). Environmental Stewards put higher priority on natural resources conservation and an ethos of social good than on higher profits. Production Maximizers prioritize producing the highest possible yields and focusing their attention and resources on the farm. For them, the economic benefits of wildlife conservation activities should be emphasized. Networking



Sutter Bypass - Daniel Nylén, American Rivers

Entrepreneurs have a business-like attitude but with a broader social network. Economic and environmental benefits should also be clearly described to them, but they may be more receptive to educational programs than Production Maximizers. Recognition of these differing management styles can be valuable for developing effective, targeted approaches to working with farmers. Some farmers need larger economic incentives to adopt wildlife management practices and less information about the practices. Others need fewer economic incentives but need to know that their specific practices result in multiple benefits that could include benefits to humans as well as habitat and wildlife conservation.

Research on conservation program design suggests that the following steps would be effective to increase Central

Valley farmers' bird habitat conservation actions: Identify farmers who have previously taken conservation actions and who are Environmental Stewards; provide them with shorter-term contracts that support large-scale conservation work (with opt-out options for significant commodity price declines or adverse weather conditions); show farmers how their specific practices will lead to social and environmental benefits for specific wildlife species in specific areas (especially on their lands) and to specific people; and recognize their work with their peers.

NON-HUNTING RECREATIONISTS:

Attitudes toward wetlands and associated wildlife, and how to foster support

Non-hunting recreationists provide significant economic value by visiting wetland habitat and by birdwatching in the Central Valley and throughout California, and they are generally willing to financially support wetland preservation. For example, a study in Merced County found that habitat management and wildlife-associated recreation contributed \$53.4 million and 1,100 jobs to the economy (Weissman 2001). Visitors to the Kern River Preserve were willing to pay \$77 (2001 dollars) to preserve that habitat, totaling about one-half million dollars (Colby and Smith-Incer 2005).

Research indicates that wetlands have value for wildlife viewing, and wildlife viewers will support water allocation to them. When recreational users understood that diverting water from wetlands reduced birdwatching and other wildlife viewing opportunities, support for water allocation for wetland habitat increased. One study found that water diverted to wetlands in the San Joaquin Valley was worth \$78 million in waterfowl hunting, fishing and wildlife viewing (1989 dollars), while the same quantity of water sold for municipal and industrial users was worth only \$19 million (Creel and Loomis 1992). Using this information with other economic data, such as the value of flood reductions gained by preserving wetlands, may increase support by the public and policymakers for water allocations for wetlands.

Research on conservation behavior of birdwatchers also illustrates the potential for this audience to be a strong constituency for conservation. A recent study in New York found that wildlife recreationists, including both hunters and birdwatchers, were four to five times more likely than non-recreationists to actively sup-



Boaters on the Sacramento River - Daniel Nylen, American Rivers

port conservation efforts (Cooper et al. 2015). Those who both hunt and birdwatch, a group that has not previously been considered in research and rarely considered in practice, had the greatest conservation behavior. Thus, hunters, birdwatchers, and especially hunter/birdwatchers could be valuable constituents for the CVJV and its partners. As for what media to use to reach these audiences, while the public has tended to want their information from television, newspapers and direct mail, wildlife watchers have wanted their information provided by conservation organizations and the parks they visit.

The 2016 NAWMP/National Flyway Council survey also studied birdwatchers in California and nationally (Slagle and Dietsch 2018). This information will be very useful to the

CVJV in understanding this audience in California and their relationship to wetlands and waterfowl conservation.

URBAN RESIDENTS:

Attitudes toward water, wetlands, and wildlife conservation, and determinants of support for water allocations for wetland birds

As many as 95 percent of California residents live in urban areas (ICIP 2016), a higher proportion than the national average (2010 data). Water resources form the main connection between wetland conservation and urban residents in California. A majority of California voters in 2015 described the state's water shortage as extremely serious (66 percent) (DiCamillo and Field 2015); 86 percent believed that water supply issues were going to be an ongoing problem (Metz and Below 2015); and 80 percent understood that residential water use reductions were "very important" (DiCamillo and Field 2015). The strongest arguments for reducing household water usage were: 1) water shortages are here to stay (97 percent found this statement very or somewhat convincing), 2) collective responsibility (93 percent) and 3) responsibility to future generations (87 percent) (Gomberg et al. 2014).

The public is split concerning support for policies that would protect the environment versus protecting water supplies for human use. In 2014, 46 percent of California voters said we "need to protect the environment, even if it hurts the water supply," compared to 36 percent who said the opposite; 55 percent were opposed to suspending environmental regulations that protect fish and wildlife (Wu 2014). The mixed support for environmental protection suggests that the three arguments for water conservation to be adapted and used for public information campaigns are ones that show how water use reductions in the city, and allocations for wetlands, are part of a necessary collective responsibility to conserve wetlands for society and our children, to reduce flooding now and in the future, and to improve water supplies for use now and in the future.



Winter-run Chinook salmon - Steve Martarano, USFWS

Innovative policy initiatives also hold promise for increasing the public's political and financial support for wetlands. When water quality improvements completed by farmers and other private landowners can be measured, they are called performance-based improvements. Urban residents have been willing to pay for performance-based water quality improvements by agricultural producers. In exchange, agricultural producers are often willing to accept payment for performance-based water quality improvements (Baird et al. 2011).

The CVJV needs to evaluate this approach further to assess if it can be modified so that agricultural producers and others who conduct wetlands restoration can have contracts with urban areas to reduce downstream flooding in the CVJV region. In one study, Califor-

nia residents indicated they were willing to pay \$35 per acre per year (1989 dollars, the equivalent of \$71 in 2019 dollars) to protect wetland quality and salmon fishing in the San Joaquin Valley and strongly supported funding for wetlands protection and salmon fishing (Pate and Loomis 1997). These results indicate there may be support for funding performance-based flood reduction programs that restore wetlands.

ECOSYSTEM SERVICES:

Integrating the economic and cultural valuation of ecosystem services into natural resource management, and how to message about these services

Ecosystem services are the benefits that ecosystems provide to humans. These benefits can include market values, such as flood protection, crop pollination and recreation, and non-market values, such as aesthetic appreciation, existence value and option value. De Groot et al. (2006) used three general types of value (ecological, sociocultural and economic) to calculate Total Economic Value (TEV) of wetlands, finding each acre of wetlands in the world provided an average value of \$1,325 per acre/year. Integrating the valuation of ecosystem services into natural resource management can highlight the economic and cultural importance of protecting land in its natural state.

Three common methods for ecosystem valuation are direct market valuation, indirect market valuation (or Avoided Cost) and contingent valuation (De Groot et al. 2006). Direct market valuation identifies the exchange value of ecosystem services in markets, as when conservation programs acquire conservation easements by paying landowners not to develop wetlands. Indirect market valuation is used when there are no explicit markets for ecosystem services. It identifies “revealed preferences” by estimating costs that would have been incurred without those services such as the value of using conservation techniques to avoid silting in a wetland, saving the cost of restoring the silted-in wetland. Contingent valuation asks respondents to state their preference for what they would be willing to pay for some ecosystem service, such as conserving a particular wetland for wildlife watching. Proponents of a fourth method argue strongly that using group decision-making is a more appropriate method to identify the ecosystem value of a service.



Birdwatchers at a Central Valley wetland - Mike Peters

Planners and decision-makers are frequently not fully aware of the connections between wetland conditions, the provision of wetland services and the economic and non-economic benefits for people. For example, one study calculated that the total economic impact of ecosystem services in Merced County equaled \$53.4 million per year and 1,100 jobs (Weissman 2001; see also Non-Hunting Recreationists section, above). Lack of awareness can lead to ill-informed decisions to allow development on wetlands. A best practice for performing an ecosystem services valuation to inform decision-making was developed by the U.S. Fish and Wildlife Service’s National Wetlands Inventory (Stelk et al. 2014). It includes these steps: 1) identify the context, 2) define the boundaries, 3) identify stakeholders, 4) develop a functional analysis, 5) perform ecosystem services

valuation, 6) develop trade-off analysis and 7) communicate results.

Using non-jargon terminology is extremely important in communicating effectively with the public. The topic of ecosystem services is especially prone to dense, jargon-rich parlance (Resource Media 2012), and the term “ecosystem services” has been shown to confuse members of the public and management experts alike. A 2010 national voter survey (Metz and Weigel 2010) found that voters strongly preferred the terms “nature’s value” or “nature’s benefits.”

ENVIRONMENTAL JUSTICE:

Socio-demographic differences in the Central Valley, environmental justice issues and how to communicate and engage with communities

Environmental justice involves empowering affected communities, which are generally low-income communities and communities of color to protect their communities' health and that of the local environment (CEJA 2015; Skelton and Miller 2016). The rapidly-growing human population of the Central Valley has a higher proportion of people of color compared to the rest of the state. For example, the Hispanic population in this region is approximately 10 percent to 20 percent higher than in the state overall (2010 U.S. Census data, summarized in CVAF n.d.), and has a large population of immigrant farm workers.

The environmental injustices in the Central Valley are well-documented and present an opportunity for collaboration between the CVJV and environmental justice organizations (EJOs), which work with affected communities, to address mutual interests. These organizations tend to be well organized, highly aware of environmental issues, involved with climate change activists, politically astute, and effective. Given these qualities, they may be open to working with conservation partners to decrease flooding and restore riparian zones in their communities as part of efforts to increase bird habitat.

Resources are available to support these partnerships. The Environmental Justice Grants program provides funds for recreational or other community amenities, and it could perhaps include restored riparian or wetland zones in vulnerable communities. Spatial planning tools, such as CalEnviroScreen (OEHHA 2017), can potentially identify communities and overlay those with watershed, flood zone and land use maps to identify where restoration of riparian zones might reduce flooding impacts, while providing wildlife habitat and recreational spaces.



Egrets in a flooded field outside Sacramento - Dave Feliz, Yolo Bypass Wildlife Area

To build collaborations, the social and political qualities of EJOs need to be considered. One approach to building effective collaboration in environmental justice contexts has been Community-Based Participatory Action Research (Bacon et al. 2013). This approach brings organizations together with communities to collaborate on a research and implementation project. The communities provide specialized, local knowledge, such as the most important flood reduction zones in their communities, based upon their knowledge of who is most vulnerable and what is most valuable in their communities. Flood control planning by restoring wetland and riparian zones, for example, could then be integrated with carefully designed flood control measures in the communities to protect their most valued areas, benefitting both groups. The communities then

become partners in advocating for flood reduction efforts that benefit wetlands, riparian areas, and people.

MULTIPLE BENEFITS:

Effectiveness of existing methods for developing strategies to manage for multiple benefits

The terms “multi-benefit” and “multiple-benefit projects” are used by the Central Valley Flood Protection Plan to refer specifically to flood control efforts that also provide environmental benefits (CDWR 2017). This Plan defines multiple-benefit projects more broadly, as land use projects designed to meet public safety needs, enhance ecological function and improve habitat quality for fish and wildlife. Multiple-benefit projects can provide benefits such as groundwater recharge, improved water quality and enhanced access to recreation. (See also the Multiple-Benefit Projects subchapter.)

Multiple-benefit approaches to conservation and planning seek to balance two or more types of benefits. The benefits might include environmental, economic and/or human welfare benefits when addressing a water and/or habitat management challenge.

Involving the public in planning multiple-benefit projects will reap long-term benefits for the CVJV. The importance of meaningful public participation and collaboration has been demonstrated and discussed extensively in the human dimensions literature. For example, Integrated Resource Management conducts multiple-benefit planning through collaborative processes among localities, state, and federal resource groups. In 2010, California established the policy that the Natural Resources Agency use Integrated Resource Management for environmental assessments, mitigation planning, etc. Early, frequent and meaningful community engagement and participation in planning riparian restoration projects has been identified as absolutely critical in building community support for, and increasing the likelihood of, successful restoration projects.



Environmental education - David Kalb

Early engagement has also helped planners identify what research needs to be conducted to address community concerns. This understanding then helps shape an overall research agenda needed to identify and select proposed alternatives. When communities are meaningfully involved, they have generally advocated for additional lands and recreational opportunities (such as fishing access) to be included in riparian restoration projects and asked for larger restoration projects. This advocacy is done with the understanding that these recreational amenities would increase economic opportunities from tourism generated from multiple-benefit projects.

These seven human dimensions topics hold great potential for enhancing the work of the CVJV over the next 10 years. Specific recommendations for acting on the information summarized here, as well as priorities for further research into these topics, are presented in the Dayer and Meyers (2016b) report, posted online at <https://www.centralvalleyjointventure.org/science/2020-implementation-plan>.

LITERATURE CITED

- Bacon C, deVuono-Powell S, Frampton ML, LoPresti T, Pannu C. 2013. Introduction to empowered partnerships: community-based participatory action research for environmental justice. *Environ Justice* 6(1):1-8. doi: 10.1089/env.2012.0019
- Baird J, Belcher K, Quinn MS. 2011. A performance-based approach to agri-environmental policy in Canada: Development and Comparative Assessment. University of Alberta Department of Resources Economic and Environmental Sociology. PR-02-2011 Project Report 201. 31 p. Available from: http://learnnetwork.rees.ualberta.ca/en/PublicationsCommunications/~media/learnnetwork/Publications%20and%20Communication/Documents/PR-02-2011_Baird-Belcher-Quinn.pdf
- Brod S, Klonsky K, Tourte L. 2006. Farmer goals and management styles: Implications for advancing biologically based agriculture. *Agric Syst.* 89(1):90-105.
- Brown MG. 2008. Assessing California's wetlands: A comprehensive survey of management techniques and a new rapid assessment method. M.S. Thesis, University of California, Davis.
- Canales E, Bergtold CE, Williams JS, Peterson J. 2015. Estimating farmers' risk attitudes and risk premiums for the adoption of conservation practices under different contractual arrangements: A stated choice experiment. Paper presented at: 2015 Agricultural & Applied Economics Association and Western Agricultural Economics Association Annual Meeting, San Francisco, CA, July 26-28, 2015. Available from: <http://ageconsearch.umn.edu/handle/205640>
- [CDFW] California Department of Fish and Wildlife. 2016. License Statistics. Available from: <https://www.wildlife.ca.gov/Licensing/Statistics>
- [CDFW] California Department of Fish and Wildlife. 2018. Department of Fish and Wildlife Budget Fact Book, FY 2018-2019. Available from: <https://nrm.dfg.ca.gov/FileHandler.ashx?DocumentID=154895&>
- [CDFW] California Department of Fish and Wildlife. 2019. California Hunting and Fishing Recruitment, Retention, and Reactivation Action Plan. Available from: <https://nrm.dfg.ca.gov/FileHandler.ashx?DocumentID=165196>
- [CDWR] California Department of Water Resources. 2017. Central Valley Flood Protection Plan 2017 Update. Available from: <http://cvfwp.ca.gov/docs/2017CVFPPUpdateFinal/2017CVFPPUpdate-Final-20170828.pdf>
- [CEJA] California Environmental Justice Alliance. 2015. Strategic Plan 2015-2018: Powering up healthy hoods throughout California. Oakland (CA). 22 p. Available from: http://caleja.org/wp-content/uploads/2015/07/CEJA_strategicplan_9.pdf
- Colby B, Smith-Incer E. 2005. Visitor values and local economic impacts of riparian habitat preservation: California's Kern River Preserve. *JAWRA* 41(3):709-717. doi: 10.1111/j.1752-1688.2005.tb03765.x
- Cooper CC, Larson L, Dayer A, Stedman R, Decker D. 2015. Are wildlife recreationists conservationists? Linking hunting, birdwatching, and pro-environmental behavior. *J Wildl Manag.* 79:446-457. doi: 10.1002/jwmg.855
- Creel M, Loomis J. 1992. Recreation value of water to wetlands in the San Joaquin Valley: linked multinomial and count data trip frequency models. *Water Resour Res.* 28(10):2597-2606. doi: 10.1029/92WR01514
- [CVAF] Central Valley Afterschool Foundation. n.d. Central Valley Demographics. Available from: <http://www.centralvalleyafterschool.org/case-for-afterschool/central-valley-demographics/>
- Dayer A, Meyers R. 2016a. Central Valley Joint Venture human dimensions literature review highlights. Central Valley Joint Venture. 31 p. Available from http://www.centralvalleyjointventure.org/assets/pdf/Dayer_and_Meyers_2016_HD_Literature_Review.pdf
- Dayer A, Meyers R. Human dimensions report. Human Dimensions Chapter. Central Valley Joint Venture. 27 p. Available from http://www.centralvalleyjointventure.org/assets/pdf/Dayer_and_Meyers_2016_HD_Manuscript.pdf.
- Dayer AA, Lutter SH, Sesser KA, Hickey CM, Gardali T. 2017. Private landowner conservation behavior following participation in voluntary incentive Programs: Recommendations to Facilitate Behavioral Persistence. *Conserv Lett.* 11(2):e12394. doi: 10.1111/cons.12394
- De Groot R, Stuij M, Finlayson M, Davidson N. 2006. Valuing wetlands: Guidance for valuing the benefits derived from wetland ecosystem services. Ramsar Technical Report No. 3/CBD Technical Series No. 27. 46 p. Available from: <https://www.cbd.int/doc/publications/cbd-ts-27.pdf>
- DiCamillo M, Field M. 2015. Californians support Governor's urban water reduction plan three to one, but many homeowners say it will be difficult for their household to cut back on their own water use. The Field Poll Release #2503. Available from: <http://www.sacbee.com/site-services/newsletters/capitol-alert-newsletter/article21342876.ece/BINARY/Field%20Poll%20results:%20state%20water%20shortage>
- Gomberg M, Maestu R, Oppenheimer E. 2014. Urban water supplier drought response survey results and observations. Sacramento (CA). Office of Research, Planning, and Performance. California State Water Resources Control Board. PowerPoint. July 17, 2014. 13 p. Available from: https://www.waterboards.ca.gov/board_info/minutes/2014jun/061714_10_staffpres.pdf
- [ICIP] Iowa Community Indicators Program. 2016. Urban percentage of the population for states, historical. Available from: <http://www.icip.iastate.edu/tables/population/urban-pct-states>
- Klöckner CA. 2013. A comprehensive model of the psychology of environmental behaviour – a meta-analysis. *Global Environ Chang.* 23(5):1028-1038. doi: 10.1016/j.gloenvcha.2013.05.014

- Larson LR, Stedman RC, Decker DJ, Siemer WF, Baumer MS. 2014. Exploring the social habitat for hunting: toward a comprehensive framework for understanding hunter recruitment and retention. *Hum Dimens Wildl.* 19(2):105-122. doi: 10.1080/10871209.2014.850126
- Manfredo MJ. 2008. *Who cares about wildlife?: Social science concepts for exploring human-wildlife relationships and conservation issues.* New York: Springer. 228 p.
- Metz D, Below C. 2015. Key findings from a recent survey on water conservation in California. Los Angeles (CA). Fairbank, Maslin, Maullin, Metz & Associates (FM3). Unpublished polling data. 9 p.
- Metz D, Weigel L. 2010. Key findings from recent national opinion research on ecosystem services. Los Angeles (CA), Alexandria (VA). Fairbank, Maslin, Maullin, Metz & Associates and Public Opinion Strategies. Unpublished polling data. 12 p. Available from <https://www.conservationgateway.org/Documents/Summary/Memo/Polling.pdf>
- Moses R. 2013. California rice grower participation in the Conservation Security Program and wildlife conservation behavior on working land. M.S. Thesis, University of California, Davis.
- [NAWMP] North American Waterfowl Management Plan, Plan Committee. 2012. *North American Waterfowl Management Plan 2012: People Conserving Waterfowl and Wetlands.* 47 p. Available from: https://nawmp.org/sites/default/files/2017-12/NAWMP-Plan-EN-may23_0.pdf
- [OEHHA] Office of Environmental Health Hazard Assessment. 2017. SB 535 Disadvantaged communities. Available from: <https://oehha.ca.gov/calenviroscreen/sb535>
- Parkhurst, B. 2011. An evaluation of ranch and farm operator attitudes towards emerging ecosystem service markets in California and Eastern North Carolina. M.E.M. Degree, Nicholas School of the Environment at Duke University, Durham, NC. Available from: http://dukespace.lib.duke.edu/dspace/bitstream/handle/10161/3689/Ben_Parkhurst_MP_Final_2011.pdf?sequence=1
- Pate J, Loomis J. 1997. The effect of distance on willingness to pay values: a case study of wetlands and salmon in California. *Ecol Econ.* 20:199-207. Available from: <https://www.sciencedirect.com/science/article/pii/S0921800996000808?via%3Dihub>
- Resource Media. 2012. *Ecosystem services messaging: needs assessment and initial messaging recommendations.* Seattle (WA). Bullitt Foundation. 23 p. Available from: www.ucanr.edu/sites/RangelandES/General/?uid=600&ds=577
- Sheeder R, Lynne GD. 2011. Empathy conditioned conservation: "Walking-in-the-shoes-of-others" as a conservation farmer" *Land Econ.* 87(3):433-434. Available from: <http://le.uwpress.org/content/87/3/433.short.pdf>
- Skelton R, Miller V. 2016. The environmental justice movement. National Research Defense Council. Available from: <https://www.nrdc.org/stories/environmental-justice-movement>
- Slagle K, Dietsch A. 2018. National survey of waterfowl hunters: Summary report Pacific Flyway. Report to the National Flyway Council from the Minnesota Cooperative Fish and Wildlife Research Unit, University of Minnesota and The Ohio State University. St. Paul, MN. Available from: https://nawmp.org/sites/default/files/2018-03/National%20Survey%20of%20Waterfowl%20Hunters%20Pacific%20Flyway_1_0.pdf
- Stelk MJ, Christie J. 2014. Ecosystem service valuation for wetland restoration: what it is, how to do it, and best practice recommendations. Windham (ME). Association of State Wetland Managers. 74 p. Available from: <http://bibliotecavirtual.minam.gob.pe/biam/bitstream/handle/minam/1832/BIV01603.pdf?sequence=1>.
- [USFWS] U.S. Fish and Wildlife Service. 2013. *National survey of fishing, hunting, and wildlife-associated recreation California, revised.* Washington, DC: U.S. Department of the Interior, U.S. Fish & Wildlife Service. Available from: <https://www.census.gov/prod/2013pubs/fhw11-ca.pdf>
- Weissman KG. 2001. *Land use and economics study grassland ecological area Merced County, California.* Los Banos (CA) Grassland Water District. 35 p. Available from: Weissman@Traenviro.com
- Wu, S. 2014. Poll: Drought freaks out more California voters. Available from: <http://www.futurity.org/drought-poll-california-voters/>

SECTION III



CONSERVATION OBJECTIVES BY BIRD GROUP



6	Introduction to Bird Conservation Objectives	95
7	Non-Breeding Waterfowl	98
8	Breeding Waterfowl	124
9	Non-Breeding Shorebirds	150
10	Breeding Shorebirds	164
11	Breeding and Non-Breeding Waterbirds	176
12	Breeding Riparian Landbirds	190
13	Breeding Grassland-Oak Savannah Landbirds	202
14	At-Risk Bird Species	214

INTRODUCTION TO BIRD CONSERVATION OBJECTIVES

This section of the Central Valley Joint Venture (CVJV) Implementation Plan (hereafter, “the Plan”) summarizes the science used to establish the Plan’s conservation objectives. The section contains a chapter about each distinct group of birds included in the Plan, defined by habitat, taxonomy, and/or season, as well as a chapter with a focus on at-risk bird species in the Central Valley. The CVJV has applied the best available science to develop conservation objectives. Experts on each bird group used existing data from the Central Valley region, employed established methods, and developed new methods when necessary, to determine the estimated number of individual birds and associated acres of habitat required in the Central Valley to support viable bird populations.

The Conservation Objectives

For non-breeding shorebirds, breeding shorebirds, non-breeding and breeding waterbirds, breeding riparian landbirds, and breeding grassland-oak savannah landbirds, conservation objectives have been established for two timeframes. The first set are long-term, 100-year conservation objectives that, if achieved, would indicate ultimate conservation success. These conservation objectives are highly ambitious and very long-term. They should be considered “stretch goals,” that is, those that inspire creativity to accomplish what currently seems impossible (Manning et al. 2006). The second set are short-term, 10-year conservation objectives that align with the timeframe of this Plan. These short-term objectives were used to develop the overall CVJV habitat objectives, which consider overlap among the needs of different bird groups as well as social and economic factors (see the Human Dimensions of Bird Conservation chapter).

The At-Risk Bird Species chapter does not provide conservation objectives but creates the first-ever Central Valley-specific list of declining and vulnerable avian taxa (species, sub-species, and distinct populations).

Breeding and non-breeding waterfowl were treated somewhat differently. Planning for waterfowl was guided by the North American Waterfowl Management Plan (NAWMP 2012), an international agreement to conserve waterfowl populations across the continent. The NAWMP establishes continental population objectives for ducks, geese and swans. Regional Joint Ventures share the responsibility to determine the amount and type of habitat required to support the population objectives in each region.

This CVJV Plan establishes long-term habitat objectives for non-breeding waterfowl in the Central Valley, based on duck population objectives determined for this region (Fleming et al. 2017) and on current goose and swan populations. This Plan also establishes population objectives for breeding ducks in the Central Valley, using the general principles outlined in the NAWMP, albeit at a local scale. NAWMP population objectives and corresponding habitat objectives to support them are considered long-term and are subject to periodic revision as directed by the NAWMP Committee or the CVJV.

The chapters that follow are summaries of the science employed to inform the overarching CVJV conservation objectives and conservation delivery strategies (Conservation Delivery chapter). Peer-reviewed publications that form the basis for the conservation objectives described here can be found in the online journal San Francisco Estuary and Watershed Science (Volume 15, Issue 1, 2017) for all bird groups except waterfowl. For waterfowl, the science used to inform objectives is derived from several sources and peer-reviewed publications, which are identified in the respective Breeding and Non-Breeding Waterfowl chapters.



2

(1) Sandhill cranes flying over wetland - Tom Grey (2) “Modesto” song sparrow - Brian Gilmore

Confidence Ranks

The CVJV and consulting experts assigned a qualitative confidence rank, from Low to High, to each bird group's conservation objectives (Table 6.1). These confidence ranks are intended to indicate a level of scientific certainty. It is important to note that each rank is only defined relative to the other bird groups. Hence, a High rank does not mean the CVJV has complete information, only that the state of knowledge is more advanced than for bird groups ranked as Medium or Low. Similarly, a Low rank does not mean the objectives are meaningless or derived from guesswork, but rather, that they are based on less, or less precise, existing knowledge.

Setting robust conservation objectives is a difficult endeavor. The confidence that scientists place in the final products is dependent on the type, amount and quality of the data as well as the methods available to turn that data into conservation objectives. Hence, knowing the confidence level of the conservation objectives for each bird group can be useful in interpreting the results and, more importantly, in weighting their use in conservation planning. Additionally, those bird groups with Low-ranked objectives could be raised in priority for additional research so that their objectives can be updated with better information.

Priority research needs for each bird group are outlined in the 2010 CVJV Monitoring and Evaluation Plan (CVJV 2010), which will be updated to improve future planning efforts. The next update of this needs assessment is slated to begin in 2020.

Additional information, from monitoring and from directed research,

BIRD GROUP	CONFIDENCE RANK	INFORMATION NEEDED TO SET OR IMPROVE OBJECTIVES
Non-breeding Waterfowl	High	Future trends in rice farming and compatibility of postharvest rice field management with waterfowl needs; improved estimates of food availability and depletion rates in key habitats.
Breeding Waterfowl	Low	Improved knowledge of key variables that influence recruitment of young, especially nest and duckling survival; improved knowledge of the contribution of recent landscape changes to population declines.
Non-Breeding Shorebirds	Medium	Invertebrate energy density estimates by land cover type and over space and time; spatially-explicit habitat availability; impacts of shifting climate patterns on habitat availability and food energy supply.
Breeding Shorebirds	Low	Better estimates of breeding densities and distribution by habitat type and planning regions (particularly for killdeer); improved estimates of reproductive success by habitat and region.
Breeding and Non-Breeding Waterbirds	Low	Better estimates (by planning region) of population sizes, densities in key habitats, and energy or resource needs, particularly for non-breeding and solitary breeding waterbirds.
Breeding Riparian Landbirds	Medium	Better estimates of breeding densities by habitat type and geography.
Breeding Grassland-Oak Savannah Landbirds	Medium	Better estimates of breeding densities and distribution by habitat type and geography.
At-Risk Bird Species	N/A	Quantification of current population sizes; extent of key habitats; bird densities within those habitats; energy resource requirements and the amount available in a given extent of habitat by season.

TABLE 6.1 Relative confidence ranks of conservation objectives for each bird group, and the highest-priority information needed to improve confidence in future planning activities.

is needed for all bird groups as part of the adaptive management framework, to inform current understanding and plan for future periodic updates.

LITERATURE CITED

- [CVJV] Central Valley Joint Venture. 2010. Monitoring and Evaluation Plan. Sacramento, CA: U.S. Fish and Wildlife Service. Available from: <http://www.centralvalleyjointventure.org>
- Fleming KK, Brasher MG, Humburg DD, Petrie MJ, Soulliere GJ. 2017. Derivation of regional, non-breeding duck population abundance objectives to inform conservation planning. North American Waterfowl Management Plan Science Support Team Technical Report No. 2017-01. 32 pp. Available from: <https://www.fws.gov/migratorybirds/pdf/management/NAWMP/DerivationofNon-breedingDuckPopulationAbundanceObjectives.pdf>
- Manning AD, Lindenmayer DB, Fischer J. 2006. Stretch goals and backcasting: approaches for overcoming barriers to large-scale ecological restoration. *Restor Ecol.* 14:487-492.
- [NAWMP] North American Waterfowl Management Plan. 2012. North American Waterfowl Management Plan 2012: people conserving waterfowl and wetlands. North American Waterfowl Management Plan. Available from: <https://www.fws.gov/birds/management/bird-management-plans/north-american-waterfowl-management-plan.php>



1

NON-BREEDING WATERFOWL

7



2

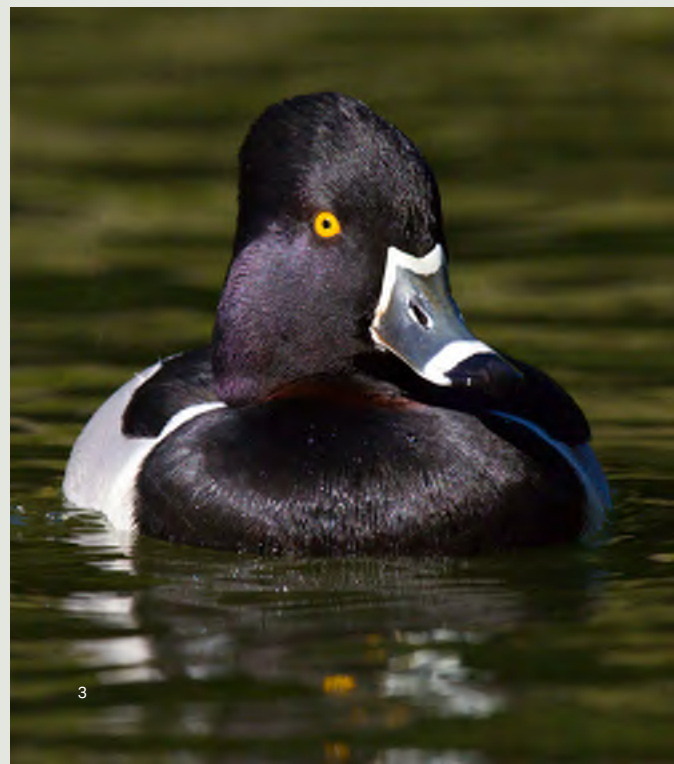

3

CHAPTER SUMMARY

The Central Valley provides critical habitat for numerous North American waterfowl species during their winter and/or migration seasons. The Central Valley Joint Venture applies the objectives of the North American Waterfowl Management Plan to create landscape conditions that support abundant and resilient populations of these waterfowl species.

This chapter describes the conservation objectives for wetland restoration and enhancement, wetland water supplies, and acreage of rice and corn agriculture needed to support the Valley's waterfowl populations under different types and degrees of potential future changes to habitat quality and quantity. The Implementation Plan used a food energetics model (TRUEMET) to develop these objectives.

The Conservation Delivery chapter in Section I integrates the waterfowl habitat objectives with the habitat objectives for other bird groups in the Implementation Plan to present total habitat needs in the Central Valley. The chapter then describes conservation actions for achieving these integrated habitat objectives.

HABITAT TYPE

Non-breeding waterfowl in the Central Valley use a mix of managed seasonal wetlands and postharvest rice and corn fields. The quality and quantity of foods in these habitats, and the availability of water to winter-flood or summer-irrigate these habitats over the course of the year, are key factors for waterfowl survival and later reproductive success.

SUCCESS STORY: Willow Creek Ranch – Managing Water For Multiple Uses

Water for wetlands in the Central Valley is limited and will only become more so in the future. This trend highlights the need to use the water currently available in a way that maximizes habitat benefits for wildlife. One outstanding example of this approach is the Willow Creek Ranch: 7,050 acres of privately-owned wetlands and wildlife-friendly rice fields located adjacent to two National Wildlife Refuges.

Over the years, individual landowners in the area had improved wildlife habitat on their properties. But existing topography and infrastructure limited water-use efficiency and water and habitat management capabilities. Although there had been efforts in the past to make repairs to this degraded system, a comprehensive upgrade was needed. Enter Ducks Unlimited (DU), Willow Creek Mutual Water Company, and numerous private landowners. Through a series of projects on the ranch, individual duck clubs have been refurbished by DU and California Waterfowl Association, and a landscape approach to water conveyance is underway.

Project work to date has increased water efficiency, allowing the water to be reused up to five times before leaving the ranch. The work has reduced mosquito production and greatly improved wetland management capabilities for waterfowl. This big-picture approach to wetland conservation, together with an outstanding partnership, is improving habitat on the scale needed to achieve the Central Valley Joint Venture's objectives for non-breeding waterfowl.

LONG-TERM HABITAT OBJECTIVES: WHAT'S NEEDED?

**MAINTAIN EXISTING MANAGED WETLANDS:
219,000 ACRES**

**WETLAND RESTORATION:
69,000 ACRES**

**ANNUAL WATER SUPPLIES:
1,360,000 ACRE-FEET**

**WINTER-FLOODED RICE HABITAT:
341,000 ACRES**

**GRAIN CORN HABITAT:
34,000 ACRES**

BIRD SPECIES INCLUDE:

Representative waterfowl in the Central Valley in the non-breeding season



Northern pintail*



American wigeon***

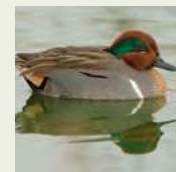

Green-winged teal**



Mallard****



Canvasback**



Lesser snow goose***



Greater white-fronted goose**

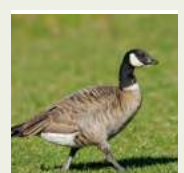

Aleutian cackling goose**

* Image: Dale Garrison ** Image: Tom Grey *** Image: Mike Peters
**** Image: Robert McLandress

(1) Northern pintail - Mike Peters (2) Snow geese - Jeff McCreary
(3) Ring-necked duck - Mike Peters

INTRODUCTION

The Central Valley of California supports one of the largest concentrations of non-breeding waterfowl (ducks, geese and swans) in the world despite the loss of more than 90 percent of its historical wetland acreage (Heitmeyer et al. 1989; Fleskes 2012). Approximately 60 percent of the Pacific Flyway's waterfowl winter in the Central Valley, with a third or more of North America's pintail (*Anas acuta*), and almost all the continental population of tule white-fronted geese (*Anser albifrons elgasi*) and Aleutian cackling geese (*Branta canadensis leucopareia*) (Gilmer et al. 1982; Petrie et al. 2016). In addition to waterfowl that winter in the Central Valley, many species depend on habitats in the Valley during migration between their northern breeding grounds and wintering areas in the south, including the Salton Sea and coast of southern California, the Baja California Peninsula, and western Mexico.

Conservation planning for waterfowl in the Central Valley has its roots in the North American Waterfowl Management Plan (NAWMP 2012). A key challenge to NAWMP implementation has been the need to develop a set of regional habitat objectives that collectively support the NAWMP's continental waterfowl population objectives. As the NAWMP approached its 20th anniversary, an international steering committee evaluated the plan's success. In doing so, the committee identified the planning actions needed to produce a consistent and cohesive set of Joint Venture habitat objectives across the North American landscape (ASC 2007). Those actions included Biological Planning, Conservation Design, and Conservation Delivery. The Central Valley Joint Venture (CVJV) adopted these planning actions to develop the waterfowl chapters for this updated Implementation Plan (hereafter, "the Plan").

- Biological Planning includes the scale at which planning regions are established; clearly defined assumptions about the limiting biological factors and waterfowl demographic parameters being addressed; and the development of population-habitat models that reflect these limiting factors and demographic parameters.
- Conservation Design addresses the fundamental questions of how much conservation, of what type, and where. CVJV waterfowl conservation design begins with habitat objec-

tives that describe the amount of habitat needed to support waterfowl population objectives in each planning region of the Central Valley. It also includes annual targets for wetland enhancement and water supply. The objectives were informed by waterfowl ecology during the non-breeding period, an evaluation of the existing amount and composition of habitat available to waterfowl in each planning region of the Central Valley, and an assessment of future threats to that habitat.

- Conservation Delivery identifies the primary approaches to meet both habitat and bird population objectives. The Conservation Delivery chapter of this Plan identifies potential future scenarios and a process that allows for adaptability in identifying and implementing priority conservation strategies and actions.

For this Plan, the CVJV considered all NAWMP waterfowl species that winter in or migrate through the Central Valley in numbers sufficient enough that conservation actions would have a population- or sub-population-level impact. The CVJV focuses its conservation objectives on ducks because species like northern pintail remain well below NAWMP population objective. In contrast, goose populations have exceeded their population objectives (Olson 2018).

CONSERVATION GOAL

The Central Valley Joint Venture's long-term goal for waterfowl is to guide regional efforts to create landscape conditions necessary to support abundant and resilient breeding and non-breeding duck populations in the Central Valley, at levels that support hunting and other uses, consistent with the North American Waterfowl Management Plan.

BIOLOGICAL PLANNING: The Science Behind CVJV Conservation Objectives

Planning Regions

Planning units represented the geographic scale at which the CVJV originally established habitat and conservation objectives for migrating and wintering waterfowl. The Central Valley's nine drainage basins served as the planning units in both the 1990 and 2006 Implementation Plans (CVHJV 1990; CVJV 2006). Historically, these drainage basins produced distinct wetland complexes within the Central Valley. They range in size from 170 square miles to 5,600 square miles (Figure 7.1). However, the 2020 Implementation Plan combines some drainage basins into larger planning regions. The American, Butte, Colusa, and Sutter basins were combined into the Sacramento planning region, while the Yolo and Delta drainage basins were combined into the Yolo-Delta planning region. The Suisun, San Joaquin, and Tulare planning regions are consistent with previous CVJV plans (Figure 1). The decision to combine drainage basins reflects the belief that conservation opportunities vary widely among some adjacent basins, and that consolidating these basins provided greater flexibility for meeting waterfowl needs.

Limiting Biological Factors

Conservation planning for migrating and wintering waterfowl in the Central Valley is largely driven by the food limitation hypothesis, which states that food availability during the non-breeding period influences survival and reproductive success through its effects on body condition (Brasher 2010; Williams et al. 2014). The fundamental assumption is that ensuring adequate food is available and reducing energetic costs of securing food during fall and winter allows birds to maintain good body condition and thus, their overwinter survival will be improved (Delnicki and Reinecke 1986; Bergan and Smith 1993; Thomas 2004; Heitmeyer 2006;

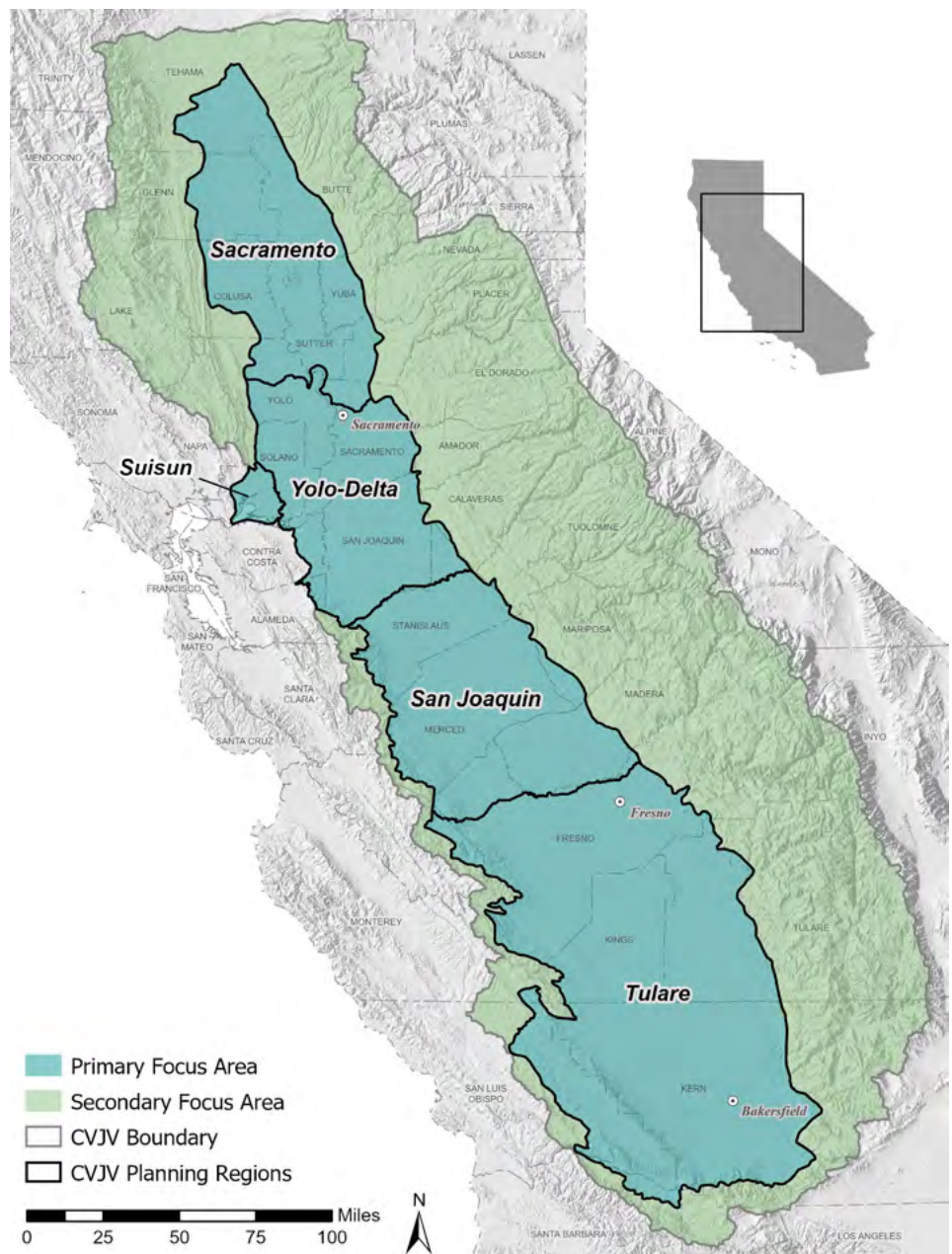

FIGURE 7.1 Central Valley Joint Venture perimeter and Primary Focus Area, divided into five planning regions.

Moon and Haukos 2006; Fleskes and Yee 2007; Moon et al. 2007). Moreover, it appears that habitat conditions during winter and spring benefit breeding productivity (Heitmeyer and Fredrickson 1981; Kaminski and Gluesing 1987; Raveling and Heitmeyer 1989; Guillemain et al. 2007; Devries et al. 2008; Anteau and Afton 2009).

Population – Habitat Model

Most Joint Ventures use a food energy approach to establish conservation objectives for migrating and wintering waterfowl (Williams et al. 2014). Waterfowl scientists developed the TRUOMET bioenergetics model (Petrie et al. 2016) to estimate waterfowl habitat requirements by comparing food energy needs to food energy supplies. Consistent with the 2006 CVJV Implementation Plan, the CVJV adopted the TRUOMET model for the 2019 Implementation Plan. The model calculates population-level energy needs from the daily energy requirements of a single bird multiplied by time-specific population size objectives. Food energy supplies are dependent on the availability and amount of waterfowl habitat, as well as the quantity and quality of foods contained in these habitats. The model accounts for the combined effects of waterfowl consumption, decomposition of foods over time, and changes in habitat availability that result from wetland flooding schedules or other events such as the timing of agricultural harvest. The CVJV used the TRUOMET model to evaluate the current habitat conditions for waterfowl relative to population food energy needs, identify any habitat shortfalls, and evaluate future threats to waterfowl habitat in the Central Valley. The model was also used to help establish the habitat and conservation objectives for waterfowl in each planning region. Key inputs used in the TRUOMET model are described below.

Waterfowl Population Objectives and Daily Energy Needs

Waterfowl can be divided into foraging guilds to reflect differences in the foods eaten (Petrie et al. 2016). For this Plan, the CVJV focused on two waterfowl foraging guilds: ducks and geese. More than 90 percent of all ducks in the Central Valley are dabbling ducks, with the remainder being diving ducks. The Plan treats diving ducks and dabbling ducks as a single foraging guild to account for their potential competition for food resources, especially wetland plant seeds in managed seasonal wetlands. The goose guild contains three species of “dark” geese, including greater white-fronted geese (*Anser albifrons*), western Canada geese (*Branta canadensis moffitti*), and Aleutian cackling geese (*Branta hutchinsii leucopareia*), and two species of “white” geese, including lesser snow geese (*Anser caerulescens caerulescens*), and Ross’s geese (*A. rossii*). Although the 2006 Plan separated white and dark geese into

different foraging guilds, recent work on the diets of dark geese in the Central Valley indicates they should not be separated based on food consumption (Skalos 2012). As a result, the current Plan treats all goose species as a single foraging guild. Tundra swans (*Cygnus columbianus*) are also included in the goose guild. They have similar dietary needs and are present in the Central Valley in much smaller numbers compared to geese.

Ducks

The CVJV derived duck population objectives for the entire Central Valley from the NAWMP as described by Fleming et al. (2017) (Table 7.1). To partition the Central Valley duck population objectives among planning regions, a percentage of this total objective was assigned to each region based on an understanding of duck distribution and the desire to maintain traditional hunting opportunities throughout the Central Valley (Table 7.2; CVJV 2006). The population abundance objectives established by Fleming et al. (2017) correspond to a single mid-winter period in early January. However, ducks are present in the Central Valley from mid-August through the end of March and their overall numbers vary considerably over this six-month period. To account for this temporal variation in bird abundance, the CVJV established 15-day interval population objectives from August 15 to March 28 by combining the population objectives from Fleming et al. (2017) with information on duck migration chronology for the Central Valley and for each planning region (Petrie et al. 2011).

The estimate of the daily food energy needs of an “average duck” in the Central Valley was drawn from Miller and Newton (1999).

Geese

Many North American goose populations have exceeded their population objectives (USFWS 2014). As a result, Joint Ventures have been advised to use recent goose counts as the population objectives when developing implementation



Greater white-fronted geese in postharvest-flooded rice field - California Rice Commission

SPECIES	MID-WINTER OBJECTIVE
Wood duck (<i>Aix sponsa</i>)	144,672
Cinnamon teal (<i>Spatula cyanoptera</i>)	2,490
Northern shoveler (<i>Spatula clypeata</i>)	596,917
Gadwall (<i>Mareca strepera</i>)	146,676
American wigeon (<i>Mareca americana</i>)	844,473
Mallard (<i>Anas platyrhynchos</i>)	737,894
Northern pintail (<i>Anas acuta</i>)	1,613,310
Green-winged teal (<i>Anas crecca</i>)	805,690
Total Dabbling Ducks	4,892,122
Canvasback (<i>Aythya valisineria</i>)	109,651
Redhead (<i>Aythya americana</i>)	40,158
Ring-necked duck (<i>Aythya collaris</i>)	79,517
Scaup (greater, <i>Aythya marila</i> , and lesser, <i>Aythya affinis</i> , combined)	184,450
Ruddy duck (<i>Oxyura jamaicensis</i>)	130,609
Total Diving Ducks	544,385
Total Ducks	5,436,507

TABLE 7.1 Mid-winter duck population objectives for the Central Valley, “stepped down” from the NAWMP (Fleming et al. 2017). These mid-winter population objectives were combined with information on duck migration chronology to establish population objectives by 15-day period annually between August 15 and March 28.

plans (Koneff 2003). To estimate the number of geese in the Central Valley, the CVJV calculated three-year averages for each goose species based on the most recent surveys of each (Table 7.3). These surveys are generally timed to coincide with peak goose numbers. To estimate the number of geese in the Central Valley for each 15-day interval between August 15 and March 28, the CVJV averaged the peak population estimate for each species over the most recent three years of surveys and combined this peak value with information on migration chronology (Petrie et al. 2011), then distributed the total population size in each interval among the five planning regions, based on survey data (Fleskes et al. 2005). More than 80 percent of all geese found in the Central Valley occurred in the Sacramento Valley (i.e., Sacramento and Yolo-Delta planning regions).

The estimate of the daily food energy needs of geese was determined using the methodology established in Miller and Eadie (2006).

PLANNING REGION	PERCENT OF TOTAL CVJV DUCK POPULATION OBJECTIVE	PERCENT OF TOTAL CURRENT CVJV GOOSE POPULATION
Sacramento	47%	79%
Yolo-Delta	15%	10%
Suisun	5%	<1%
San Joaquin	25%	10%
Tulare	8%	<1%

TABLE 7.2 Percent of the total CVJV duck population objective, and current goose population numbers, assigned to each planning region.

SPECIES	PEAK NUMBER
White geese (lesser snow geese, <i>Anser caerulescens caerulescens</i> , and Ross’s geese, <i>Anser rossii</i>).	1,375,300
Greater white-fronted geese (<i>Anser albifrons</i>)	675,051
Aleutian cackling geese (<i>Branta hutchinsii leucopareia</i>)	164,250
Western Canada geese (<i>Branta canadensis moffitti</i>)	5,914
Tundra swans (<i>Cygnus columbianus</i>)	62,102
Total Geese and Swans	2,282,617

TABLE 7.3 Peak numbers of geese and tundra swans in the Central Valley, based on the average of the last three survey years.

Area and Availability of Waterfowl Foraging Habitats

The CVJV assumed ducks in the Central Valley rely on three major foraging habitats: managed seasonal wetlands, harvested rice fields that are winter-flooded, and harvested grain corn fields whether flooded or not. It was assumed that ducks consume seed resources and macro-invertebrates in seasonally managed wetlands, waste grain in winter-flooded rice fields, and waste grain in harvested cornfields. Geese were assumed to forage in both harvested rice fields and harvested grain corn fields whether flooded or not. Geese are believed to use wetlands mostly for roosting (Skalos 2012).

Managed Seasonal Wetlands

To determine the area of managed seasonal wetlands now present in the Central Valley, as a whole and by planning region, the CVJV used estimates produced from 2009 satellite imagery (Petrik et al. 2014) supplemented by the area of wetlands restored between 2009 and 2015 (D. Fehringer, unpublished data, 2016, see “Notes”; Table 7.4). Consistent with the 2006 Plan, this 2020 Plan uses the flooding schedules estimated for public and privately managed seasonal wetlands in the Central Valley provided by wetland managers. These flooding schedules were used for modelling the temporal availability of managed seasonal wetlands in the Central Valley as a whole and in each of the five planning regions.

PLANNING REGION	MANAGED SEASONAL WETLANDS
Sacramento	68,495
Yolo-Delta	21,954
Suisun	28,752
San Joaquin	58,375
Tulare	18,834
Total	196,410

TABLE 7.4 Managed seasonal wetland estimates (acres) for the Central Valley, identified by planning region.

Rice

Between 2007 and 2014, on average, 541,362 acres of rice were harvested in the Central Valley (USDA 2015). The Plan relies on that average figure, even though drought conditions after 2014 reduced the amount of planted rice (Petrie et al. 2016). Rice harvest in the Central Valley generally begins in early September, with nearly all fields harvested by early November. The model excluded 4,536 acres of rice grown in the San Joaquin planning region because nearly all these acres are tilled and left dry after harvest, providing little foraging value to waterfowl (CVJV 2006). Approximately 95 percent

of all rice occurs in the Sacramento planning region, with approximately 63 percent of all harvested rice fields being winter-flooded (Table 7.5). To determine the area of winter-flooded rice by 15-day time period in each planning region, the CVJV relied on estimates based on satellite imagery of winter-flooded rice from late September through the end of March (Dybala et al. 2017). For harvested rice fields that are not winter-flooded, 25 percent of these fields were assumed to be “deep-plowed” and provide no waterfowl food resources (CVJV 2006).

PLANNING REGION	PLANTED	WINTER-FLOODED	UNFLOODED	DEEP-PLOWED
Sacramento	509,873	324,847	138,763	46,263
Yolo-Delta	26,953	15,823	8,346	2,784
Suisun	0	0	0	0
San Joaquin	4,536	0	0	4,536
Tulare	0	0	0	0
Total	541,362	340,670	147,109	53,583

TABLE 7.5 Rice habitat estimates (in acres) for the Central Valley, identified by planning region.

Grain Corn

Between 2011 and 2013, an average of 137,634 acres of grain corn was harvested in the Central Valley, mostly in the Yolo-Delta planning region (USDA 2014). The model relies on this average figure. The CVJV assumed that only 25 percent of all harvested grain corn fields provide waterfowl food resources and that postharvest practices in the remaining fields make most or all unharvested corn unavailable to waterfowl (Table 7.6; Matthews 2019). The timing of grain corn harvest was assumed to be similar to that for rice (CVJV 2006).

PLANNING REGION	PLANTED	PROVIDE FOOD	PROVIDE NO FOOD
Sacramento	29,624	7,406	22,218
Yolo-Delta	108,008	27,002	81,006
Suisun	0	0	0
San Joaquin	0	0	0
Tulare	0	0	0
Total	137,634	34,408	103,224

TABLE 7.6 Grain corn habitat estimates (in acres) for the Central Valley, identified by planning region.

Habitat Foraging Values

Managed Seasonal Wetlands

The CVJV obtained moist-soil seed production estimates for managed seasonal wetlands in the Central Valley from Naylor (2002) (Table 7.7). However, consistent with the 2006 Plan, it was assumed that seed production in managed seasonal wetlands within the Suisun and Tulare planning regions is lower than elsewhere in the Central Valley (CVJV 2006). The CVJV assumed seed production in the Suisun region was 50 percent lower due to water quality (salinity) and plant species composition, and that seed production in the Tulare region was 25 percent lower because of a lack of water for summer irrigation. In addition, waterfowl do not consume all the food energy available in wetlands because foraging efficiency declines with decreasing food biomass (Reinecke and Loesch 1996). As a result, the CVJV adopted a “foraging threshold” of 13 kg/acre, below which waterfowl give up trying to feed and move on to a different field. This threshold value represents the minimum amount of food remaining in managed seasonal wetlands at the end of March (Naylor 2002; CVJV 2006). This foraging threshold was applied to all seasonal wetland and agricultural habitats.

Rice

The amount of waste rice remaining in Central Valley rice fields for use by waterfowl varies by harvest method. Conventionally harvested fields averaged 157 kg/acre of waste rice, while stripper-headed fields averaged 99 kg/acre (Fleskes et al. 2012). Because an estimated 18 percent of all rice fields in the Central Valley are now stripper-head harvested (Fleskes et al. 2012), a weighted average of 147 kg/acre waste rice was used. Consistent with the 2006 Plan, the CVJV assumed that 15 percent of the available waste rice is consumed by non-waterfowl species (CVJV 2006), reducing the average amount available to waterfowl to 125 kg/acre. However, harvested rice fields were also assumed to provide an additional 11 kg/acre of moist soil seeds (CVJV 2006), resulting in a total seed biomass of 136 kg/acre. To account for the waterfowl foraging threshold of 13 kg/acre, the total available seed biomass was estimated to be 123 kg/acre (Table 7.7).

Grain Corn

Recent sampling of grain corn fields within the Central Valley indicate that these habitats only provide about 66 kg/acre of waste corn after accounting for the waterfowl foraging threshold of 13 kg/acre (Table 7.7; pooled data from Shaskey 2016 and Raquel 2017). This equates to about one percent of the average corn yield for the Central Valley and is consistent with other studies that have estimated the amount of corn remaining after harvest (Krapu et al. 2004).

Invertebrates

Seasonal shifts in diet suggest that invertebrate consumption by most Central Valley ducks is minimal prior to January; however, invertebrates can be more than 50 percent of the diet from January through March (Euliss and Harris 1987; Miller 1987). Consistent with the 2006 Plan, the CVJV assumed that managed seasonal wetlands provide 13 kg/acre of invertebrate biomass beginning January 1 (Table 7.7; CVJV 2006). Although winter-flooded rice undoubtedly provides some invertebrate resources, these foods were not included in the TRUOMET model because rice fields are quickly drained in late January after the close of the hunting season, and the invertebrate food resources they provide are uncertain (Petrie et al. 2016).

True Metabolizable Energy

Although waterfowl carrying capacity of a given habitat is strongly dependent on food biomass, it is also a function of the energy or calories provided by these foods. Therefore, true metabolizable energy estimates (TME values) for moist-soil seeds, rice, corn, and invertebrates were obtained from published sources for use in the TRUOMET model (Table 7.7).

FOOD TYPE	FOOD DENSITY (KG/ACRE)	TRUE METABOLIZABLE ENERGY (TME) (KCAL/G)
Moist-Soil Seeds	225 ^{a,b}	2.5
Rice	123 ^b	3.0
Corn	66 ^b	3.9
Invertebrates	13	2.39

^a Food density estimate of moist soil seeds reduced by 25 percent and 50 percent respectively for managed seasonal wetlands in the Tulare and Suisun planning regions. Weighted moist soil seed density for entire Central Valley equals 203 kg/acre.

^b Estimates reduced by 13 kg/acre, because waterfowl stop feeding when seed densities are that low.

TABLE 7.7 Food types, density and true metabolizable energy of important waterfowl foods in the Central Valley.

CONSERVATION DESIGN:

How much conservation, of what type, and where?

Methods for Establishing Conservation Objectives

Several types of conservation objectives were defined for ducks in each planning region: (1) habitat objectives, which represent the total area (acres) of each type of habitat needed to support the region's duck population objectives; (2) water supply objectives, which represent the amount of water needed to provide duck habitat on those acres; and (3) wetland enhancement objectives, which include both ongoing management efforts to enhance food supply, and maintenance of and improvements to infrastructure required to manage the water supply. In addition, the CVJV Lands Committee used information from this chapter to (4) define objectives for the protection of agricultural habitats in the Sacramento planning region, through conservation easements.

The CVJV defined habitat objectives for managed seasonal wetlands, winter-flooded rice fields, and harvested grain corn fields, which provide nearly all the foraging habitat available to ducks in the Central Valley. Objectives for these habitats were partly determined by the relative importance of each based on an understanding of non-breeding waterfowl ecology, the existing habitat available relative to duck population objectives, and future threats to that habitat (described below). For example, agricultural habitats play little to no role in supporting duck populations in some planning regions and a critical role in others.

For each planning region, the CVJV defined the habitat objectives by first determining the proportion of the duck population objectives each habitat type should support, and then using TRUOMET to model the total area of each habitat type required. For managed seasonal wetlands, a restoration objective is defined as the difference between the total habitat objective and the current area of managed seasonal wetlands. Water supply objectives were also defined for managed seasonal wetlands in each planning region with the assumption that the wetland restoration objectives will be met. These water supply objectives are based on the Central Valley Wetlands Water Supply Investigations (USFWS 2000), which provides estimates of the amount of reliable and affordable water required for optimal management of seasonal wetlands in the Central Valley. These requirements differ by both time period and planning region; this information was used when estimating water needs.

The CVJV also defined two types of wetland enhancement objectives. The first, Type I, is the acres of wetlands each year for which wetland and water conveyance infrastructure is repaired or enhanced. Based on interviews with resource

managers, it was determined that this infrastructure will require some form of enhancement, on average, every twelve years. Therefore, the annual wetland enhancement objective is defined as one-twelfth of the total wetland area in a planning region. Wetland enhancement objectives are expressed on a yearly basis and are perpetual. However, the acreage needing enhancement each year will increase over time in regions where the CVJV is restoring additional wetland acres. This is because, when total wetland acreage increases year over year, the acres needing infrastructure enhancement will also increase over time. The increases in Type I enhancement objective acreage are calculated based on restoration in 2,000-acre increments, to show progress toward meeting the wetland restoration objective.

The second type of wetland enhancement objective, Type II, addresses annual management activities that increase food production (e.g., disking of wetlands to set back wetland plant succession). For each planning region, these Type II objectives were established by estimating the percent increase in food production on existing wetlands that would reduce, by a given percentage, the number of additional acres needed of wetland restoration. Reductions in wetland restoration acreage were modeled at 25 percent intervals. The CVJV assumes that increases in food production will mostly come from these annual enhancement efforts but recognizes that Type I enhancement can also contribute to increases in average food production for wetlands in a planning region. It is worth noting that Naylor (2002) documented wide variation in food production among managed wetlands (100 kg/acre – 600 kg/acre), much of it due to management practices. This wide range suggests that there is considerable opportunity to optimize food production in Central Valley wetlands through implementing best practices.

Finally, because rice provides most of the agricultural habitat in the Central Valley (Table 7.8), the CVJV Lands Committee established an objective of protecting 10 percent of the existing rice base in the Sacramento and Yolo-Delta planning regions over the next ten years using conservation easements. Easements will be prioritized in the Sacramento planning region as most rice is grown there and rice provides most of the nutritional needs of non-breeding waterfowl in this region (Table 7.8). Agricultural easements can also serve to buffer existing wetlands from disturbance and development, so rice habitat that is adjacent to wetlands should be a priority for protection. Other factors such as the risk of conversion, reliability of surface water supplies, and size and cost of parcels under consideration for protection would also be important in determining easement priorities.

PLANNING REGION	MANAGED WETLANDS	WINTER-FLOODED RICE		HARVESTED GRAIN CORN		AGRICULTURAL LANDS: RICE AND CORN
Sacramento	25%	74%	+	1%	=	75%
Yolo-Delta	50%	23%	+	27%	=	50%
Suisun	100%	0%		0%		0%
San Joaquin	100%	0%		0%		0%
Tulare	100%	0%		0%		0%
Central Valley Overall	44%	52%	+	4%	=	56%

TABLE 7.8 Relative contribution (%) of wetlands and agriculture (rice and corn) to total duck food energy in the Central Valley.



Green-winged teal - Tom Grey

Informing the Conservation Objectives

Non-Breeding Waterfowl Ecology

Although conservation planning for waterfowl in the Central Valley is based on the food limitation hypothesis, this hypothesis does not address how food energy should be provided to waterfowl. Agricultural grains such as rice and corn are high in digestible energy content (Table 7.7); however, they are nutritionally incomplete because they lack some of the amino acids required by non-breeding waterfowl (Sherfy 1999). Therefore, in the 2006 Plan, the CVJV stipulated that seeds from wetland plants in managed seasonal wetlands must meet 50 percent or more of duck food energy needs in a given planning region. With this “wetland stipulation” (called a “wetland constraint” in the 2006 Plan), the CVJV assumes that meeting at least half of duck food energy from wetland food sources will allow birds to access a nutritionally complete diet.

The Existing Conservation Landscape for Waterfowl

To evaluate the existing conservation landscape for waterfowl, the first step was to determine the contribution of each habitat type to total food energy for ducks and geese. For ducks, 56 percent of the total food energy in the Central Valley is provided by agricultural habitats, mostly winter-flooded rice, with the rest provided by managed seasonal wetlands (Table 7.8). However, these proportions vary among planning regions. Agricultural habitats provide 75 percent of the food energy available to ducks in the Sacramento planning region, while there is an even split between agricultural and wetland sources in the Yolo-Delta region. In the Suisun, San Joaquin and Tulare planning regions, managed seasonal wetlands are assumed to provide 100 percent of the food resources available to ducks (Table 7.8).

For geese, the CVJV assumed that agricultural habitats provide nearly all the food consumed in the Central Valley, with 95 percent of this total provided by rice (winter-flooded rice and unflooded rice). Although rice dominates the diet of white-fronted geese in the Sacramento planning region from October through January, birds also consume the rhizomes of alkali bulrush. During February and March, white-fronted geese shift to a diet comprised mostly of green forage (Skalos 2012). Because the availability of bulrush tubers or green forage is unknown, the estimate of food availability for geese in the Central Valley is incomplete. This lack of data is especially pronounced for the February and March time periods when green forage increasingly dominates goose diets (Skalos 2012).

Waterfowl foraging habitats are also categorized by ownership and protection status. An estimated 66 percent of all managed seasonal wetlands in the Central Valley are privately owned and maintained as duck hunting clubs, with the remainder (34 percent) being public (Table 7.9; CVJV 2006). Similar proportions are found in the Sacramento and Yolo-Delta planning regions, but privately managed wetlands account for nearly 80 percent of all wetlands in the Suisun and San Joaquin planning regions and only a third of all wetlands in the Tulare planning region. For this analysis, all agricultural habitats are assumed to be privately owned, although a small amount (up to 3,500 acres) of rice is grown under contract by local farmers on state wildlife areas (B. Olson, personal communication, 2019, see “Notes”).

The protection status of waterfowl habitat in the Central Valley varies by habitat type. All state- and federally-owned wetlands are permanently protected, while approximately 90 percent of all privately owned wetlands are protected through conservation easements that prevent their conversion to

PLANNING REGION	PRIVATE WETLANDS ^{a,b}	PUBLIC WETLANDS ^{a,b}	TOTAL WETLANDS ^a
Sacramento	41,097 (60%)	27,399 (40%)	68,496
Yolo-Delta	14,051 (64%)	7,903 (36%)	21,954
Suisun	22,720 (79%)	6,032 (21%)	28,752
San Joaquin	44,949 (77%)	13,426 (23%)	58,375
Tulare	6,215 (33%)	12,619 (67%)	18,834
Central Valley Total	129,032 (66%)	67,379 (34%)	196,411

^a Estimated wetland area: from D. Fehring, personal communication, 2016, see "Notes."

^b Percentage of private vs. public wetlands: from CVJV 2006.

TABLE 7.9 Ownership and extent (in acres) of Central Valley managed seasonal wetlands, by planning region. (Sums may not be exact, due to rounding in original data.)

other land uses (CVJV 2006). Only about 6,000 acres (one percent) of private rice habitat is protected, all of it through conservation easements in the Sacramento planning region (V. Getz, personal communication, 2019, see "Notes"). For each planning region, the level of habitat protection was evaluated in terms of the area of duck foraging habitat protected and the percent of total duck food energy (in an average year) that occurs in protected habitats. For the Suisun, San Joaquin and Tulare planning regions, more than 90 percent of all habitat and duck food energy is protected. In contrast, only 25 percent of all duck food energy and 18 percent of all habitats are protected in the Sacramento planning region. In the Yolo-Delta planning region, about half of duck food energy and approximately one third of the total area of habitat are protected (Table 7.10). It is important to note that while the land is protected, food energy provided by these habitats is not, and maintaining current levels relies on active management and water availability.

TRUOMET and the model inputs described in the Biological Planning section were used to evaluate the carrying capacity of the Central Valley and each planning region relative to their duck population objectives. Food energy supplies for

PLANNING REGION	% HABITAT ACRES PROTECTED	% TOTAL FOOD ENERGY PROTECTED
Sacramento	18%	25%
Yolo-Delta	32%	47%
Suisun	92%	92%
San Joaquin	92%	92%
Tulare	97%	97%

TABLE 7.10 Relative portion of duck foraging habitat and total food energy protected in each planning region.

ducks in the Central Valley overall appear sufficient to support the population objectives from late August until March (Figure 7.2). Large food surpluses in fall and early winter are the result of traditional flooding schedules of managed seasonal wetlands that provide habitat well before most ducks have arrived in the Central Valley (Petrie et al. 2016). In the Sacramento and Suisun planning regions, food energy supplies for ducks appear sufficient in all time periods. In contrast, in the Yolo-Delta planning region, although early season flooding of managed wetlands produces an initial food surplus for ducks, food supplies are projected to be exhausted by mid-February. Similarly, both the San Joaquin and Tulare planning regions appear unable to support their duck population objectives as food resources are estimated to be exhausted by February (Figure 7.2).

Although the CVJV's conservation objectives are focused on ducks, the carrying capacity of geese in the Central Valley overall was also evaluated. Most geese occur in the Sacramento and Yolo-Delta planning regions. Unlike for ducks, the carrying capacity analyses for geese were based on current goose estimates, which are mostly above population objectives (with the exception of tule greater white-fronted geese). Food energy supplies for geese in the Central Valley as a whole are projected to be exhausted by mid-February, while goose food supplies in the Sacramento and Yolo-Delta planning regions were exhausted by early March and early February, respectively (Figure 7.3). However, it is important to note that the model does not include green forage as a food source. Geese in the Central Valley rely heavily on green forage in February and March (Skalos 2012), so it is likely that geese have more food energy available than is reflected in the model.

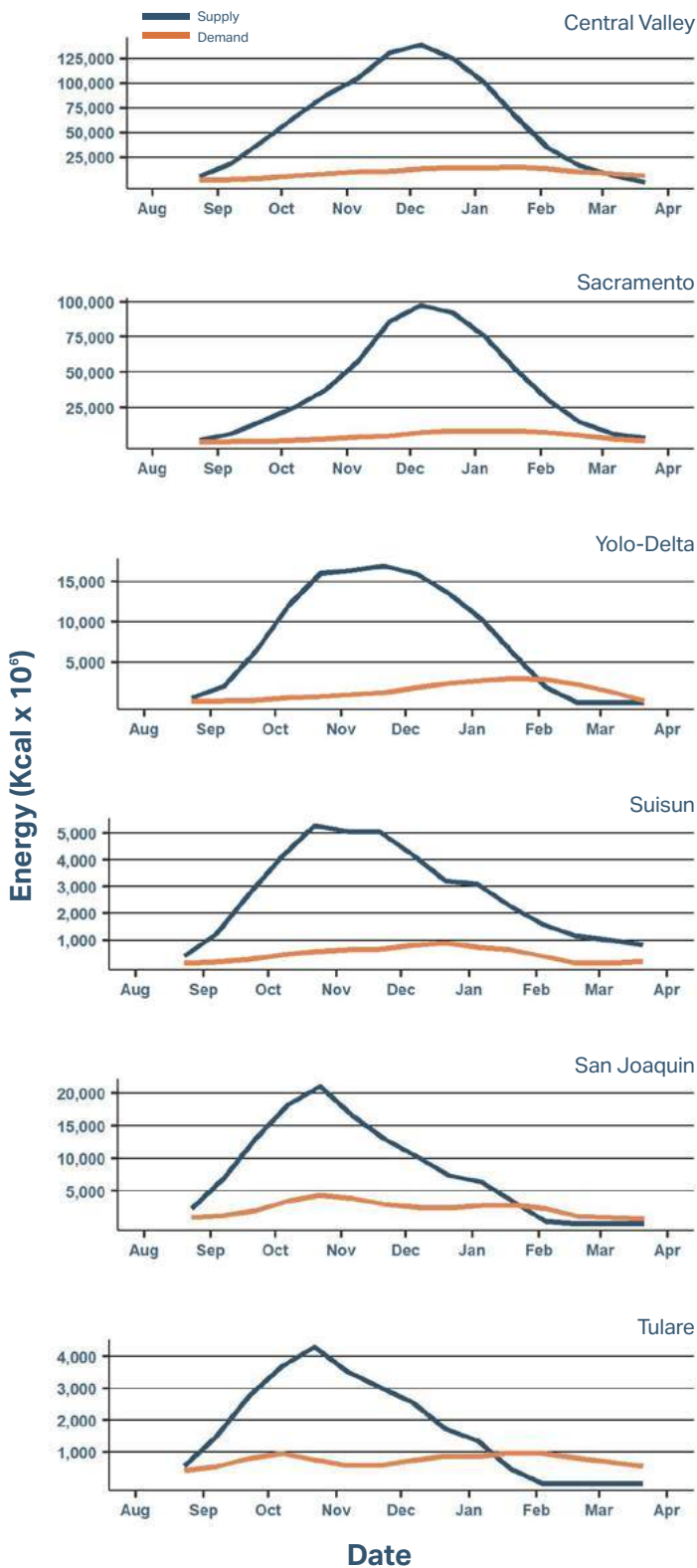

FIGURE 7.2 Duck population energy supply (blue) vs. food energy demand (orange) (in kcal x 10⁶) for the Central Valley as a whole and for each planning region.

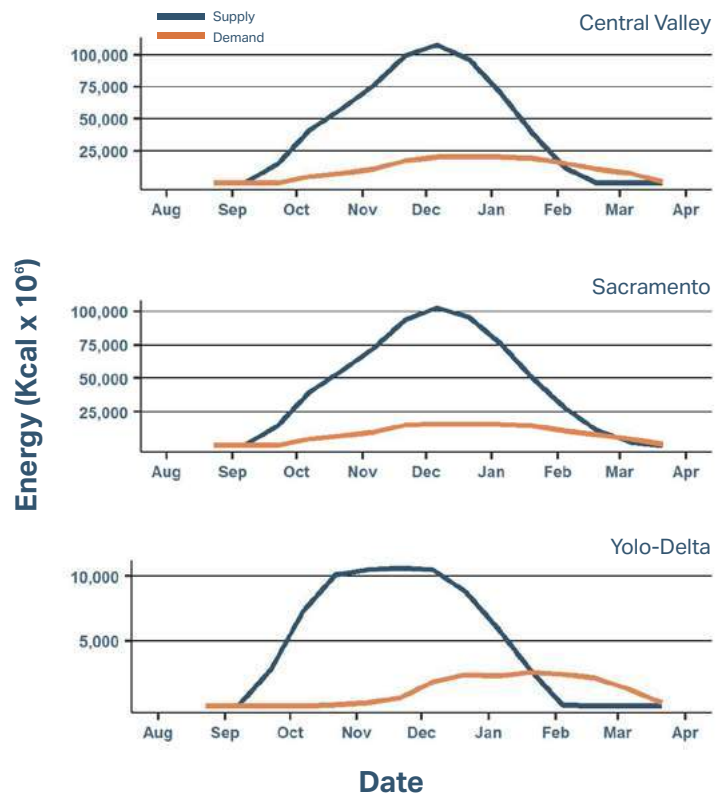

FIGURE 7.3 Goose population energy supply (blue) vs. food energy demand (orange) (in kcal x 10⁶) for the Central Valley as a whole and for each planning region.

Future Threats – Scenario Descriptions

Although the CVJV's conservation objectives are primarily informed by the existing amount and composition of habitat available to waterfowl, the objectives also incorporate future threats to that habitat. Four broad threats to waterfowl habitats in the Central Valley are: 1) insufficient water supplies for managed seasonal wetlands, 2) changing postharvest practices that reduce the food resources provided by agricultural habitats, 3) reduced investments in private wetland management, and 4) increasing numbers of geese. The TRUOMET modeling explores the possible effects of each future threat on waterfowl carrying capacity represented by nine scenarios (Table 7.11). While these model simulations were conducted for the Central Valley as a whole, they are intended to provide inference at the scale of the planning regions as well. Understanding how these threats move the Central Valley landscape away from the desired condition for waterfowl also informed the CVJV's discussion about Conservation Delivery and the programs and policies needed to address these threats.

Water supplies are managed on seasonal wetlands for three general purposes: flood-up from late summer through fall,

maintaining water levels from fall through spring, and summer irrigating in June and July (CVPIA IRP 2009). Approximately 56 percent of all managed seasonal wetlands in the Central Valley are summer irrigated during a typical year, according to CVJV surveys of land managers. Seed biomass in these irrigated wetlands is nearly 60 percent greater than in non-irrigated wetlands (Naylor 2002), making them important habitats for waterfowl. During the recent drought, however, wetland managers estimated that only 10 percent of all wetlands were summer irrigated, while 75 percent of all wetlands were still flooded at a normal level during fall and winter (Petrie et al. 2016). Water demand in the Central Valley is highest in mid-summer for both agricultural and urban users, so obtaining surface water supplies for summer irrigation of managed wetlands in low water years may be difficult.

The first scenario in the Future Threats exercise modeled the way in which a reduction in summer irrigation would impact duck carrying capacity. In this scenario, summer irrigation of all managed wetlands in the Central Valley was eliminated, except for wetlands in the Suisun planning region, where irrigation water supplies are not likely to be limited even in drought years (S. Chappell, personal communication, 2019, see “Notes”; Scenario #1). This scenario would have the estimated effect of reducing the average seed biomass in managed wetlands by 20 percent, from 203 kg/acre to 161 kg/acre. Scenario #2 re-runs this no-summer-irrigation scenario assuming that only 75 percent of existing wetlands were flooded during the traditional fall flooding period, because of a lack of surface water supplies.

More than half of all food available to ducks in the Central Valley is provided by agricultural habitats (Table 7.8). These agricultural food sources can be subject to economic drivers that are beyond the influence of the waterfowl management community and are virtually unprotected. These food resources may decline due to changing crop types, increased harvest efficiency, or postharvest practices that reduce the availability of waste grains. Because rice provides nearly all the agricultural foods available to ducks, modeling was focused on this habitat type. Although the recent California drought reduced the amount of rice planted in the Central Valley, rice production had been stable prior to the drought (Petrie et al. 2014). Similarly, the amount of rice remaining after harvest does not appear to have changed since the mid-1980s (Fleskes et al. 2012). As a result, the CVJV believes that the greatest threat to agricultural food sources for ducks is a decline in winter-flooded rice. To model this potential threat, Scenarios #4 and #5 reduce the food resources now provided by winter-flooded rice by 50 percent and 100 percent, respectively.

Approximately two-thirds of all managed seasonal wetlands in the Central Valley are privately owned and maintained as duck hunting clubs, most of which are permanently protected through conservation easements (CVJV 2006). Although this ownership pattern makes the outright loss of these habitats unlikely, private wetland owners are not obligated to maintain these wetlands in a highly managed way. Well-managed duck clubs require a substantial investment of time and money. If new club members cannot be recruited because of an overall decline in hunter numbers, or a decrease in hunting opportunity discourages future investment in these properties, the contribution of these privately managed wetlands to waterfowl carrying capacity may decline. To explore how changes in private wetland management may affect waterfowl carrying capacity in the Central Valley, the food resources now provided by these habitats was reduced by 50 percent in the TRUOMET model (note that total wetland food biomass was only reduced to 66 percent of current levels because the CVJV assumed there would be no change for publicly managed habitats). This decline in food resources could result from some duck clubs being idled, fewer food resources being produced on some clubs because of a lack of financial resources, or a combination of both (Scenario #5).

The 2006 Plan assumed a peak number of 1.08 million geese in the Central Valley (CVJV 2006). However, peak counts of geese in the Central Valley now average nearly 2.3 million birds (Table 7.3). Increasing numbers of geese may reduce the food energy available to ducks through exploitive competition of shared food resources. Most of this competition presumably involves winter-flooded rice, based on foraging habitats typically used by both ducks and geese in the Central Valley. The CVJV included geese as a threat because most are already above population objectives; future population increases may reduce duck food resources, similar to postharvest practices that reduce waste grains for ducks.

To explore the possible effects of geese on duck food resources within the limitations of the TRUOMET model, the CVJV examined the rate at which geese consume agricultural food resources in the Central Valley under current and projected population estimates. The first simulation used current estimates of goose and swan numbers (because swan numbers are folded into goose population estimates) and assumed that these birds had access to current levels of winter-flooded rice, unflooded rice, and grain corn (Scenario #6). Then, the goose number was increased by 50 percent and 100 percent while keeping agricultural habitats unchanged (Scenario #7 and Scenario #8, respectively). Ducks were not included in any simulation in order to isolate the effects of growing goose populations on agricultural foods.

Although each of these possible future threats to waterfowl habitat was evaluated in separate modeling scenarios, some of these threats are related and could occur simultaneously. For example, the same water shortages that curtail the summer irrigation or fall flooding of managed wetlands would probably reduce the amount of winter-flooded rice as well. To address that, one additional model scenario was developed where multiple future threats occur simultaneously. This scenario included conditions where only 75 percent of all managed seasonal wetlands were flooded, no summer irrigation of any wetland habitats occurred outside of Suisun Marsh, winter-flooded rice was reduced to 50 percent of current levels, and goose and swan numbers were 50 percent higher than they are today (Scenario #9).

Future Threats – Scenario Highlights

- When no managed wetlands (outside of the Suisun planning region) were summer irrigated (Scenario #1; Figure 7.4), all available duck food resources were consumed by mid-February. When only 75 percent of all wetlands were flooded (Scenario #2; Figure 7.4), food deficits occurred by early February.
- When 50 percent of all winter-flooded rice was eliminated (Scenario #3; Figure 7.4), duck food resources were unable to meet population needs by mid-February, or by mid-January when all winter-flooded rice was removed from the model (Scenario #4; Figure 7.4).
- Reducing the food resources from privately managed wetlands produced a food deficit by early February (Scenario #5; Figure 7.4).

- Geese and swans are currently capable of consuming all the agricultural food resources now available to waterfowl in the Central Valley, without any consumption by ducks, by late March (Scenario #6; Figure 7.5).
- Agricultural food resources were completely exhausted by early February when the current number of geese and swans was increased by 50 percent in the TRUOMET model (Scenario #7; Figure 7.5) and by early January when these populations were doubled (Scenario #8; Figure 7.5).
- Results for Scenario #6 (current consumption by geese and swans) may help explain the results for Scenarios #3 and #4, where declines in winter-flooded rice did not reduce the duck supply curve to the degree expected, given that winter-flooded rice supplies half of all duck food resources (Table 7.8). Geese are currently exerting considerable foraging pressure on winter-flooded rice, and this exploitive competition may be significantly diminishing the value of this habitat for ducks compared to its value in the absence of geese. As a result, reducing winter-flooded rice within the model may have a limited effect on duck food energy supplies.
- Finally, the scenario that considered multiple threats acting simultaneously on duck foraging habitats would result in a food energy deficit by early January (Scenario #9; Figure 7.6).

SCENARIO	DUCK POPULATION ^a	GOOSE POPULATION ^a	MANAGED WETLANDS ^a	WINTER-FLOODED RICE ^a	WETLAND FOOD BIOMASS ^a
#1	100%	100%	100%	100%	80%
#2	100%	100%	75%	100%	80%
#3	100%	100%	100%	50%	100%
#4	100%	100%	100%	0%	100%
#5	100%	100%	100%	100%	66%
#6	0%	100%	NA	100%	NA
#7	0%	150%	NA	100%	NA
#8	0%	200%	NA	100%	NA
#9	100%	150%	75%	50%	80%

^a Percentages indicate the value of the model parameter relative to its currently assumed value. For example, the 80% Wetland Food Biomass value in Scenario #1 reflects the estimate that eliminating summer irrigation would reduce the average seed biomass in managed wetlands in the Central Valley by 20%. NA: Not applicable to scenario.

TABLE 7.11 Summary of scenarios included in the TRUOMET model to examine future threats to duck foraging habitats and food energy supplies in the Central Valley.

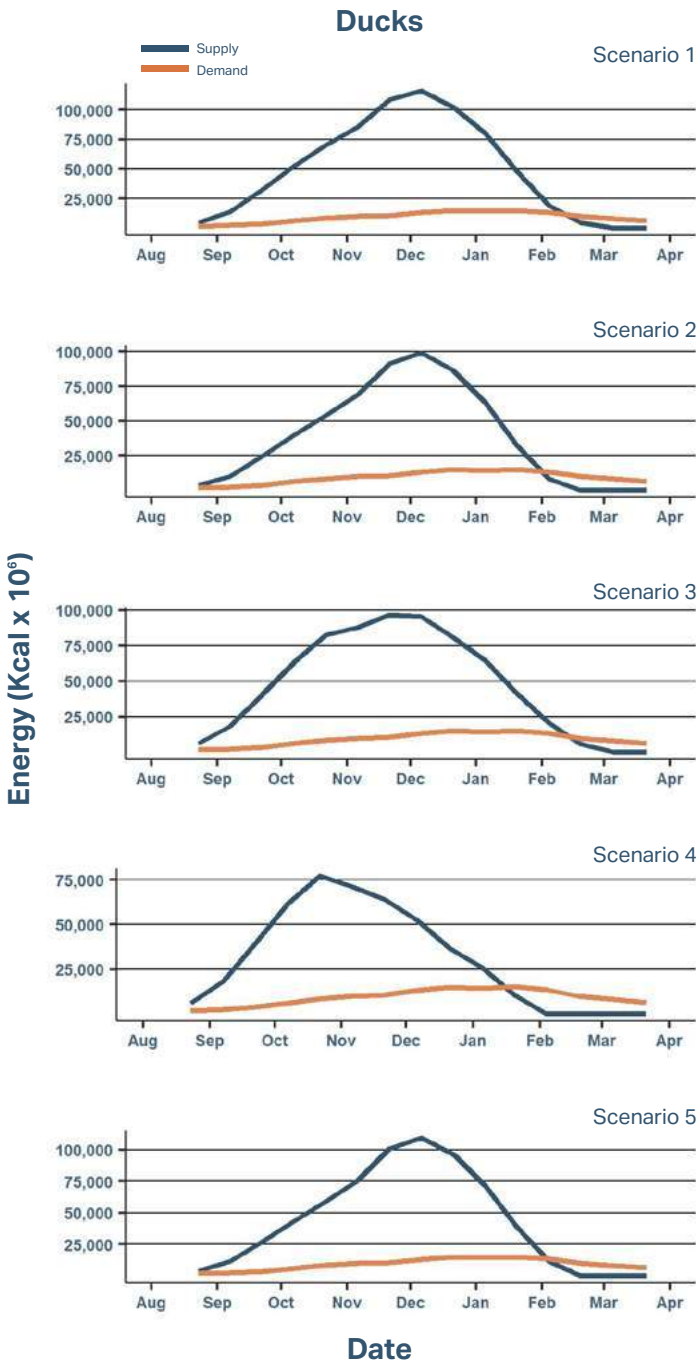

FIGURE 7.4 Duck population energy supply (blue) vs. food energy demand (orange) (in kcal x 10⁶) for the Central Valley under different model scenarios.

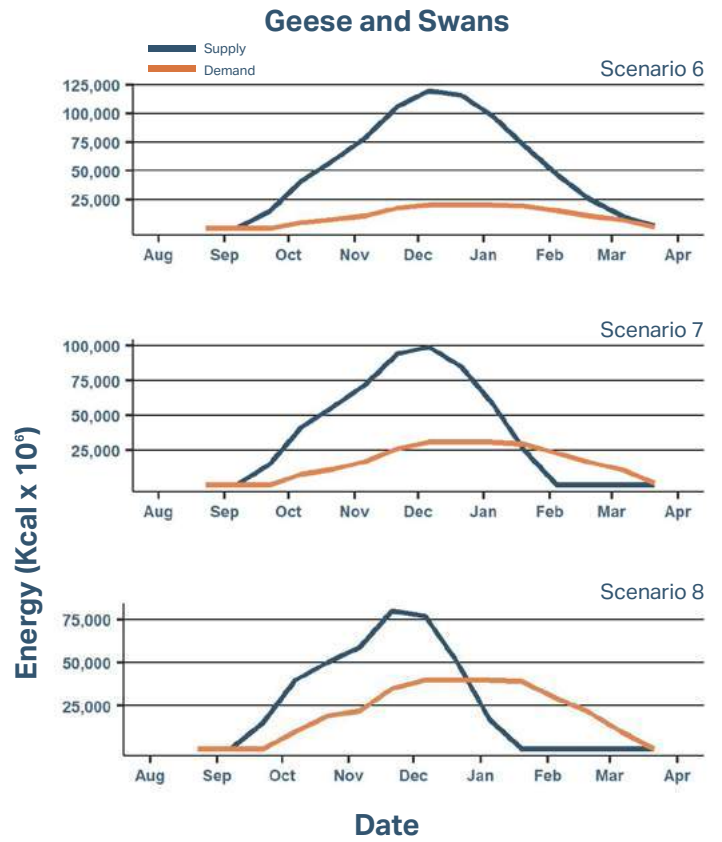

FIGURE 7.5 Goose population energy supply (blue) vs food energy demand (orange) (in kcal x 10⁶) under different model scenarios.



FIGURE 7.6 Duck population energy supply (blue) vs. food energy demand (orange) (in kcal x 10⁶) for the Central Valley when multiple threats are considered in the TRUOMET model (Scenario #9).



Types of Conservation Objectives for Ducks in the Central Valley

Habitat objectives

- Total acres of managed seasonal wetlands ("wetland habitat objectives"); winter-flooded rice fields; and harvested grain corn fields
- Restoration of additional wetland acres ("wetland restoration objectives")

Water supply objectives

Wetland enhancement objectives

- Type I: acres of existing wetlands each year that need to receive infrastructure enhancements
- Type II: annual increase in food production on existing wetlands

Protection of agricultural habitats through conservation easements (Sacramento planning region only)

Conservation Objectives by Planning Region

The CVJV applied the modeling results showing non-breeding waterfowl energy needs, current food energy supply, and possible future threats, to establish a set of conservation objectives for each planning region.

Sacramento Planning Region

Most of the duck food resources in the Sacramento planning region are provided by winter-flooded rice (Table 7.8). Although rice is of overwhelming importance to waterfowl in the Central Valley, there is considerable risk in relying too heavily on a single, unprotected habitat type, as shown in the review of Future Threats. As much as 25 percent of existing agricultural food resources in the Sacramento planning region could be lost over the next 10 years. The CVJV recommends that this potential loss be offset by creating additional managed seasonal wetlands.

In addition, meeting the “wetland stipulation” requirements would reduce the risk of habitat loss, since most of the wetlands now being restored in the Central Valley receive permanent protection. It would also help ensure that ducks are provided with a nutritionally complete diet (Sherfy 1999).

The Plan’s modeling results indicate that existing food supplies in the Sacramento planning region currently support its assigned proportion of the total duck population objectives, though there appears to be little or no food surplus in late winter and early spring (Figure 7.2). Despite these adequate food supplies under current conditions, the region will need 27,500 acres of new managed seasonal wetlands to offset the threat of losing 25 percent of agricultural food resources in this planning region. This acreage is the Plan’s wetland restoration objective. There

AGRICULTURAL FOOD RESOURCES LOST	EXISTING MANAGED SEASONAL WETLANDS	ADDITIONAL WETLAND RESTORATION NEEDED	TOTAL WETLAND AREA NEEDED
25% (current 10-year projection)	68,500	27,500 ^a	96,000 ^a
50%	68,500	52,500	121,000
75%	68,500	64,500	133,000
100%	68,500	71,500	140,000

^a Current restoration objectives for managed seasonal wetlands in the Sacramento planning region.

TABLE 7.12 Managed seasonal wetlands (in acres) needed to support wintering waterfowl populations at varying levels of agricultural food resource decline in the Sacramento planning region.

are currently an estimated 68,500 acres of managed wetlands in the Sacramento planning region. The Plan therefore defines a total habitat objective for managed wetlands in the Sacramento planning region as 96,000 acres (Table 7.12). Meeting this objective would also meet the 50 percent wetlands stipulation.

Although the wetland habitat objective is based on a 25 percent loss of agricultural foods, modeling also showed how this objective would change under different rates of loss, including the elimination of all agricultural foods (Table 7.12). Note that the wetland objectives do not increase in a linear manner with greater levels of agricultural loss. Because geese do not forage in wetlands but do compete with ducks for food in winter-flooded rice, managed wetlands are insulated from the effects of goose foraging.

Type I wetland enhancement objectives (acres of wetlands each year receiving infrastructure enhancements) and wetland water supply objectives are based on the wetland habitat objective of 96,000 acres (Tables 7.13 and 7.14). Type II wetland enhancement objectives (Table 7.15) reflect the increase in average food production needed to reduce the acreage of wetland restoration needed. For example, reducing the Sacramento

planning region’s wetland restoration objective by 25 percent (from 27,500 to 20,625 acres) would require an eight percent increase in average food production on existing wetlands to meet the food energy needs of ducks within that planning region (Table 7.15).

There are nearly 325,000 acres of winter-flooded rice and 7,400 acres of harvested grain corn currently in the Sacramento planning region (Tables 7.5 and 7.6). Because there is no meaningful food surplus in this region, the conservation objectives for these two habitat types are to maintain existing acreages. These objectives may be difficult to accomplish, however, because food resources provided to ducks by these agricultural habitats are expected to decline due to increasing goose numbers, less water for winter flooding, and changing postharvest practices. To help offset this projected decline, the CVJV Lands Committee established an agricultural protection objective of 54,000 acres for the Sacramento planning region. This objective is focused exclusively on rice fields and is to be achieved using permanent conservation easements.

WETLAND ACRES ^a	ANNUAL ENHANCEMENT OBJECTIVE ^b (ACRES)
68,500 ^c	5,686
70,500	5,852
72,500	6,018
74,500	6,184
76,500	6,350
78,500	6,516
80,500	6,682
82,500	6,848
84,500	7,014
86,500	7,180
88,500	7,346
90,500	7,512
92,500	7,678
94,500	7,844
96,000 ^d	7,968

^a In 2000-acre increments, to show progress toward the meeting the wetland restoration objective.

^b Acres needing Type I enhancements increase as progress is made in meeting the total wetland restoration objective.

^c Current acres of wetlands.

^d Wetland restoration objective.

TABLE 7.13 Annual Type I wetland enhancement objectives for the Sacramento planning region.

WETLAND RESTORATION OBJECTIVE ^a (ACRES)	TOTAL WETLANDS NEEDED ^b (ACRES)	AVERAGE FOOD PRODUCTION (KG/ACRE)
27,500 (current objective)	96,000	225 ^c
20,625	89,125	242 (8% increase) ^d
13,750	82,250	263 (17% increase) ^d
6,875	75,375	287 (28% increase) ^d
0	68,500	315 (40% increase) ^d

^a Wetland restoration objectives under varying levels of average wetland food production needed to meet duck energy requirements.

^b Existing wetlands (68,500 acres) + wetland restoration objective.

^c Current average food production estimated for managed wetlands in the Sacramento planning region.

^d Increases in average food production needed to reduce wetland restoration objectives and still meet duck energy requirements. These increases reflect the Type II wetland enhancement objectives.

TABLE 7.15 Type II wetland enhancement objectives for the Sacramento planning region. Enhancing existing acres for increased food production would reduce the acreage of additional restored wetlands needed.

MONTH	WATER NEED (ACRE-FEET)
January	19,200
February	19,200
March	19,200
April	0
May	67,200
June	0
July	0
August	86,400
September	172,800
October	38,400
November	38,400
December	19,200
Annual Need	480,000

TABLE 7.14 Water needs per month for managed seasonal wetlands in the Sacramento planning region when the total wetland habitat objective of 96,000 acres is met.

Yolo-Delta Planning Region

The food resources available to ducks in the Yolo-Delta planning region are equally split between wetland and agricultural sources, with grain corn the most abundant agricultural food (Table 7.8). Model results indicate that this planning region cannot currently support its duck population objective because food resources are exhausted by late winter (Figure 7.2). It is unlikely this food shortage can be eliminated by providing more agricultural habitats, since the amount of rice planted in Yolo-Delta is small compared to the Sacramento region (<30,000 acres), and much of this rice is already winter-flooded (nearly 60 percent; Table 7.5). The existing food deficit in Yolo-Delta should therefore be addressed by restoring managed seasonal wetlands, which would also address concerns about nutritional quality of available food for ducks in this planning region (Sherfy 1999).

As in the Sacramento planning region, the CVJV assumed a 25 percent loss of food resources from agricultural habitats in the Yolo-Delta region over the next 10 years due to increasing goose numbers, less available water for winter flooding, and evolving postharvest practices and cropping patterns. Offsetting these losses and eliminating the Yolo-Delta region food deficit using only wetlands requires a restoration objective of 18,000 acres and a total habitat objective for managed seasonal wetlands of 40,000 acres. Modeling was also used to determine how this restoration objective changed under different rates of loss, including the loss of all agricultural foods (Table 7.16). The objectives for wetland enhancement and wetland water supplies (Tables 7.17, 7.18 and 7.19) were calculated based on this habitat objective.

PERCENT OF AGRICULTURAL FOOD RESOURCES LOST	EXISTING MAN-AGED SEASONAL WETLANDS	ADDITIONAL WETLAND RESTORATION NEEDED	TOTAL WETLAND AREA NEEDED
25% (current 10-year projection)	22,000	18,000 ^a	40,000 ^a
50%	22,000	20,500	42,500
75%	22,000	22,500	44,500
100%	22,000	23,500	45,500

^a Current restoration objectives for managed seasonal wetlands in the Yolo-Delta planning region.

TABLE 7.16 Managed seasonal wetlands (in acres) needed to support wintering waterfowl populations at varying levels of agricultural food resource decline in the Yolo-Delta planning region.

WETLAND ACRES ^a	ANNUAL ENHANCEMENT OBJECTIVE ^b (ACRES)
22,000^c	1,826
24,000	1,992
26,000	2,158
28,000	2,324
30,000	2,490
32,000	2,656
34,000	2,822
36,000	2,988
38,000	3,154
40,000^d	3,320

^a In 2000-acre increments, to show progress toward the meeting the wetland restoration objective.

^b Acres needing Type I enhancements increase as progress is made in meeting the total wetland restoration objective.

^c Current acres of wetlands.

^d Acres of wetlands when restoration objectives are met.

TABLE 7.17 Annual Type I wetland enhancement objectives for the Yolo-Delta planning region.

WETLAND RESTORATION OBJECTIVE ^a (ACRES)	TOTAL WETLANDS NEEDED ^b (ACRES)	AVERAGE FOOD PRODUCTION (KG/ACRE)
18,000 (current objective)	39,954	225 ^c
13,500	35,454	254 (13% increase) ^d
9,000	30,954	290 (29% increase) ^d
4,500	26,454	340 (51% increase) ^d
0	21,954	409 (82% increase) ^d

TABLE 7.19 Type II wetland enhancement objectives for the Yolo-Delta planning region. Enhancing existing acres for increased food production would reduce the acreage of additional restored wetlands needed.

MONTH	WATER NEED (ACRE-FEET)
January	8,000
February	8,000
March	8,000
April	0
May	28,000
June	0
July	0
August	36,000
September	72,000
October	16,000
November	16,000
December	8,000
Annual Need	200,000

TABLE 7.18 Water needs per month for managed seasonal wetlands in the Yolo-Delta planning region when the total wetland habitat objective of 39,954 acres is met.

Opportunities to increase grain corn or winter-flooded rice habitats in the Yolo-Delta region are uncertain. Rice is considered a possible solution to subsidence of peat soils in the Yolo-Delta planning region (Deverel et al. 2016), but local climate and water management present challenging growing conditions and adoption is not widespread. As such, the Plan sets conservation objectives for these two habitat types to maintain current acreages.

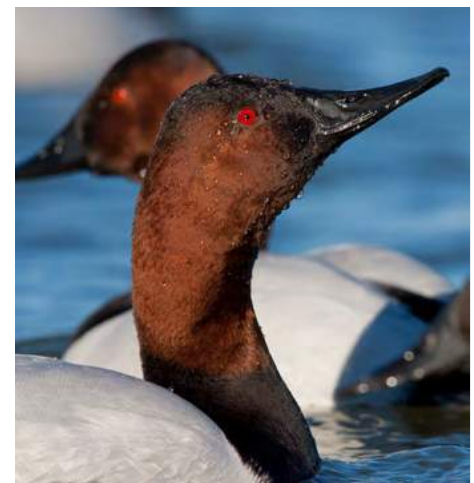

Canvasbacks - Mike Peters

^a Wetland restoration objectives under varying levels of average wetland food production needed to meet duck energy requirements.

^b Total wetlands equal existing wetlands (21,954 acres) + wetland restoration objective.

^c Current average food production estimated for managed wetlands in the Yolo-Delta planning region.

^d Increases in average food production needed to reduce wetland restoration objectives and still meet duck energy requirements. These increases reflect the Type II wetland enhancement objectives.

Suisun Planning Region

All of the food resources available to ducks in the Suisun planning region are provided by managed seasonal wetlands, so the nutritional quality of foods available to ducks in this region is considered adequate (Table 7.8). Although seed production in managed seasonal wetlands in Suisun is assumed to be only one-half that of seed production elsewhere in the Central Valley, food supplies still appear to be adequate to support the Plan's duck population objective (Figure 7.2). Therefore, the CVJV did not define a managed wetland habitat objective for this region. Although the CVJV adopted a conservative estimate of food production for this region, the spread of invasive plant species and salinity challenges may lead to levels of food production below those assumed here (D. Skalos, personal communication, 2019, see "Notes"). As a result, updated estimates of food production in Suisun Marsh managed seasonal wetlands are needed before a more reliable evaluation of waterfowl carrying capacity can be conducted.

The lack of agriculture in the Suisun planning region eliminates any concerns over changes in agricultural practices or growing numbers of geese. Although outright loss of wetlands is unlikely, The Suisun Marsh Habitat Management, Preservation, and Restoration Plan (USBR et al. 2013) calls for up to 7,000 acres of managed wetlands to be converted to tidal habitat by 2042. This conversion will reduce the available wetland foraging habitat for ducks, because tidal wetlands in Suisun are not a preferred habitat for ducks (Coates et al. 2012) and don't contribute appreciably to food energy needs of waterfowl. These planned conversions to tidal habitat increase the importance of enhancing the remaining wetlands to maintain or even increase wetland food production to offset these losses.

The Plan's annual wetland enhancement objective for the Suisun planning region is 2,386 acres per year. This objective remains constant through time, since there is no objective to restore additional wetlands in this planning region that would then need enhancements. Considerably more detail on the enhancement needs of managed wetlands in the Suisun Marsh can be found in the 2013 Suisun Marsh plan.

Table 7.20 shows the Plan's wetland water supply objective for the Suisun planning region. Because the water needs are primarily met with gravity fed water from tidal sloughs adjacent to managed wetland habitats, the salinity of the water supply varies seasonally. This variability can affect the managed wetland plant species composition as well as the amount of seed produced. The CVJV will need to monitor this situation and potentially account for it in setting conservation objectives in the future.

MONTH	WATER NEED (ACRE-FEET)
January	5,750
February	5,750
March	5,750
April	7,188
May	0
June	0
July	0
August	25,877
September	57,504
October	11,501
November	11,501
December	5,750
Annual Need	136,571

TABLE 7.20 Water needs per month for managed seasonal wetlands in the Suisun planning region.

San Joaquin Planning Region

All of the food resources available to ducks in the San Joaquin planning region are provided by managed seasonal wetlands, so the nutritional quality of these foods are considered adequate (Table 7.8). However, existing food supplies cannot currently support the San Joaquin region's duck population objective (Figure 7.2). Since suitable agricultural habitats are lacking within this region, the foraging habitat deficit can only be addressed by restoring additional seasonal wetlands.

The lack of agricultural habitats in this region eliminates any concern over long-term changes in agricultural practices, as well as concerns over competition with geese. Similarly, there is little concern over the outright loss of wetland habitats in the San Joaquin planning region as nearly all of these habitats are afforded permanent protection (CVJV 2006). However, a long-term decline in the willingness or ability of private wetland owners to invest in wetland management is a future threat, given that nearly 80 percent of all wetlands in this region are privately held (i.e., duck clubs) and these habitats provide the majority of duck food resources (Table 7.9).

Finally, insufficient affordable water supplies for wetland management may pose the greatest long-term threat to waterfowl habitat in the San Joaquin region. Shortages in water supplies for both fall flooding of seasonal wetlands and summer irrigation of these habitats are both likely.

The TRUOMET analysis indicated that a total of 70,875 acres of managed seasonal wetlands are needed to meet the food energy needs of the San Joaquin planning region's duck population objective. Given an estimated 58,375 acres of existing wetlands, the Plan set a wetland restoration objective of 12,500

TOTAL WETLAND HABITAT OBJECTIVE	EXISTING WETLANDS	WETLAND RESTORATION OBJECTIVE
70,875	58,375	12,500

TABLE 7.21 Managed seasonal wetland restoration objective (acres) for the San Joaquin planning region.

WETLAND ACRES ^a	ANNUAL ENHANCEMENT OBJECTIVE ^b (ACRES)
58,375 ^c	4,845
60,375	5,011
62,375	5,177
64,375	5,343
66,375	5,509
68,375	5,675
70,375	5,841
70,875 ^d	5,883

^a In 2000-acre increments, to show progress toward the meeting the wetland restoration objective.
^b Acres needing Type I enhancements increase as progress is made in meeting the total wetland restoration objective.
^c Current acres of wetlands.
^d Acres of wetlands when restoration objective is met.

TABLE 7.22 Annual Type I wetland enhancement objectives for the San Joaquin planning region.

MONTH	WATER NEED (ACRE-FEET)
January	14,157
February	14,157
March	14,157
April	0
May	56,628
June	17,696
July	0
August	56,628
September	141,570
October	28,314
November	28,314
December	14,157
Annual Need	385,778

TABLE 7.23 Water needs per month for managed seasonal wetlands in the San Joaquin planning region when the total wetland habitat objective of 70,785 acres is met.

WETLAND RESTORATION OBJECTIVE ^a (ACRES)	TOTAL WETLANDS NEEDED ^b (ACRES)	AVERAGE FOOD PRODUCTION (KG/ACRE)
12,500 (current objective)	70,785	225 ^c
9,375	67,750	236 (5% increase) ^d
6,250	64,625	247 (10% increase) ^d
3,125	61,500	260 (16% increase) ^d
0	58,375	274 (22% increase) ^d

^a Wetland restoration objectives under varying levels of average wetland food production needed to meet duck energy requirements.
^b Total Wetlands equals existing wetlands (58,375 acres) + wetland restoration objective.
^c Current average food production estimated for managed wetlands in the San Joaquin planning region.
^d Increases in average food production needed to reduce wetland restoration objectives and still meet duck energy requirements. These increases reflect the Type II wetland enhancement objectives.

TABLE 7.24 Type II wetland enhancement objectives for the San Joaquin planning region. Enhancing existing acres for increased food production would reduce the acreage of additional restored wetlands needed.

acres to reach the total wetland habitat objective (Table 7.21). Tables 7.22 and 7.23 show the conservation objectives for Type I wetland enhancement and wetland water supplies, respectively. Table 7.24 shows objectives for Type II wetland enhancement.



Northern shoveler - Tom Grey

Tulare Planning Region

The food resources available to ducks in the Tulare planning region are provided exclusively by managed wetlands. Though this means there are no nutritional concerns, the current amount of food resources is insufficient to support the Tulare planning region's duck population objectives (Table 7.8; Figure 7.2). The TRUOMET analysis indicated that just over 30,000 acres of managed seasonal wetlands are needed to meet nutritional objectives for ducks in this region. Given the current estimated 18,834 acres of wetlands in this region, the Plan set a wetland restoration objective of 11,166 acres to reach the total wetland habitat objective (Table 7.25). This assumes existing wetlands are flooded each year, which may not be the case when water is limited or used for other purposes. Tables 7.26 and 7.27 show the conservation objectives for Type I wetland enhancement and wetland water supplies, respectively. Table 7.28 shows the objectives for Type II wetland enhancement.

No other planning region in the Central Valley faces the conservation challenges found in the Tulare region. Finding affordable and reliable water supplies for existing wetlands, let alone those yet to be restored, remains a formidable obstacle within the Tulare planning region.

TOTAL WETLAND HABITAT OBJECTIVE	EXISTING WETLANDS	WETLAND RESTORATION OBJECTIVE
30,000	18,834	11,166

TABLE 7.25 Managed seasonal wetland restoration objective (acres) for the Tulare planning region.

WETLAND ACRES ^a	ANNUAL ENHANCEMENT OBJECTIVE ^b (ACRES)
18,834 ^b	1,563
20,834	1,729
22,834	1,895
24,834	2,061
26,834	2,227
28,834	2,393
30,000 ^d	2,490

^a In 2000-acre increments, to show progress toward the meeting the wetland restoration objective.

^b Acres needing Type I enhancements increase as progress is made in meeting the total wetland restoration objective.

^c Current acres of wetlands.

^d Acres of wetlands when restoration objectives met.

TABLE 7.26 Annual Type I wetland enhancement objectives for the Tulare planning region.

MONTH	WATER NEED (ACRE-FEET)
January	5,999
February	5,999
March	0
April	23,998
May	0
June	16,499
July	0
August	14,999
September	59,994
October	11,998
November	11,998
December	5,999
Annual Need	157,484

TABLE 7.27 Water needs per month for managed seasonal wetlands in the Tulare planning region when the total wetland habitat objective of 30,000 acres is met.

WETLAND RESTORATION OBJECTIVE ^a (ACRES)	TOTAL WETLANDS NEEDED ^b (ACRES)	AVERAGE FOOD PRODUCTION (KG/ACRE)
11,166 (current objective)	30,000	169
8,375	27,209	186 (10% increase)
5,583	24,417	208 (23% increase)
2,792	21,626	234 (38% increase)
0	18,834	269 (59% increase)

^a Wetland restoration objectives under varying levels of average wetland food production needed to meet duck energy requirements.

^b Total wetlands equals existing wetlands (21,954 acres) + wetland restoration objective.

TABLE 7.28 Type II wetland enhancement objectives for the Tulare planning region. Enhancing existing acres for increased food production would reduce the acreage of additional restored wetlands needed.

Summary

Table 7.29 shows the conservation objectives for each planning region and for the Central Valley as a whole.

PLANNING REGION	WETLAND RESTORATION (ACRES)	WETLAND ENHANCEMENT: TYPE I ^a (ACRES)	WETLAND ENHANCEMENT: TYPE II ^b (ACRES)	WATER SUPPLIES (ACRE-FEET)	AGRICULTURAL HABITAT ^c (ACRES)	AGRICULTURAL HABITAT PROTECTION (ACRES)
Sacramento	27,500	7,968	17%	480,000	325,000 WFR 7,400 GC	54,000 (rice)
Yolo-Delta	18,000	3,320	29%	200,000	16,000 WFR 27,000 GC	0
Suisun	NA	2,386	NA	136,571	NA	NA
San Joaquin	12,500	5,883	10%	385,778	NA	NA
Tulare	11,166	2,490	23%	157,484	NA	NA
Central Valley	69,166	22,047	NA	1,359,833	341,000 WFR 34,400 GC	54,000 (rice)

^a Annual wetland enhancement objective when wetland restoration objectives are met for a planning region. This objective assumes that the infrastructure of managed wetlands requires some form of maintenance on average every 12 years.

^b Percent increase in average food production in existing managed wetlands needed to reduce wetland restoration objectives by 50%. For other levels of reduced wetland restoration that correspond to increased levels of food production see earlier tables for each planning region.

^c WFR: Acres of winter-flooded rice. GC: Acres of grain corn.

NA: Not Applicable

TABLE 7.29 Conservation objectives for migrating and wintering waterfowl in the Central Valley of California.



Ducks in flight - USFWS

CONSERVATION DELIVERY: Accomplishing the Habitat Objectives

The Conservation Delivery chapter of this Plan describes the process needed to identify and implement the CVJV's priority conservation strategies to meet both habitat and bird population objectives for waterfowl. Because conservation objectives associated with agricultural easements and water needs are addressed elsewhere, the habitat objectives in this chapter were restricted to wetlands.

The CVJV partnership identified four primary mechanisms to accomplish the habitat objectives for each of the bird groups considered in this Plan. These actions include habitat protection, restoration, enhancement and management. The type of habitat protected or restored, as well as the appropriate strategies to enhance habitat, are specific to the biological needs of the focal species in each of the bird groups. For non-breeding waterfowl, wetland habitat restoration remains a high priority. Several thousand acres have been restored since the 2006 Plan, allowing the CVJV to set a smaller objective of just under 70,000 acres for this Plan. This is still a formidable goal, because the amount of wetland restoration now occurring annually in the Central Valley is only about 40 percent of what it was in the decade before the 2006 plan. This decrease is largely due to the increased demand for and cost of land with water rights sufficient for wetland development.

Though restoration has been the main mechanism for improving wetland habitat in the Central Valley, a long-term commitment to maintaining or improving the quality of existing managed wetlands is equally important. This work can be accomplished through annual management activities using prescribed techniques such as vegetation disturbance (e.g., disking or burning) or summer irrigation to

directly increase food production and carrying capacity (Type II Enhancement). The success of annual wetland management is dependent on periodic efforts to maintain well-functioning management infrastructure (Type I Enhancement). Infrastructure includes maintenance levees, water conveyance components (control structures, pumps and wells), and wetland bottom slope and topography that allows for desired hydrology and habitat values.

The costs associated with habitat protection, restoration and varying levels of enhancement and management continue to increase. Additionally, the surface and ground water required for wetlands to function is increasingly expensive to secure. Having well-funded programs that support all wetland conservation priority actions on both private and public wetlands will be critical to these efforts.

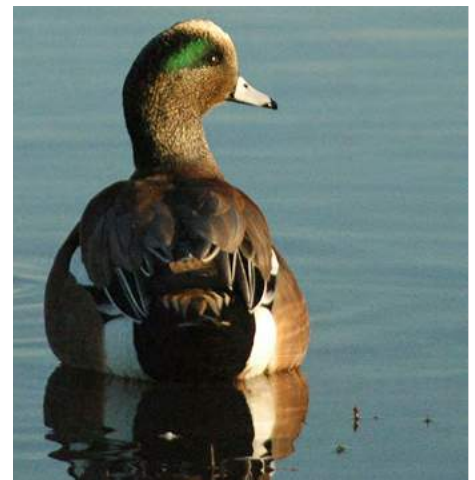

American wigeon - Dale Garrison

LITERATURE CITED

- Anteau MJ, Afton AD. 2009. Lipid reserves of lesser scaup (*Aythya affinis*) migrating across a large landscape are consistent with the "spring condition" hypothesis. *The Auk* 126(3):873-883. doi: 10.1525/auk.2009.08193
- [ASC] Assessment Steering Committee. 2007. North American Waterfowl Management Plan Continental Progress Assessment. Final report. Canadian Wildlife Service, U.S. Fish and Wildlife Service, Secretaria de Medio Ambiente y Recursos Naturales. Available from: <https://hawmp.org/sites/default/files/2018-02/2007ContinentalAssessment.pdf>
- Bergan JF, Smith LM. 1993. Survival rates of female mallards wintering in the Playa Lakes region. *J Wildl Manag.* 57: 570-577.
- Brasher MG. 2010. Duck use and energetic carrying capacity of actively and passively managed wetlands in Ohio during Autumn and Spring migration, PhD dissertation, The Ohio State University, Columbus, OH.
- Coates PS, Casazza ML, Halstead BJ, Fleskes JP. 2012. Relative value of managed wetlands and tidal marshlands for wintering northern pintails. *J Fish Wildl Manag.* 3:98-109.
- [CVHJV] Central Valley Habitat Joint Venture. 1990. Central Valley Habitat Joint Venture Implementation Plan. U.S. Fish and Wildlife Service. Sacramento, CA.
- [CVJV] Central Valley Joint Venture. 2006. Central Valley Habitat Joint Venture Implementation Plan – Conserving bird habitat. U.S. Fish and Wildlife Service. Sacramento, CA.
- [CVPIA IRP] CVPIA Independent Review Panel. 2009. Undelivered water: Fulfilling the CVPIA promise to Central Valley Refuges. Central Valley Project Improvement Act Refuge Water Supply Program. Available at: https://www.usbr.gov/mp/cvpia/docs_reports/indep_review/CVPIA_Final_Refuge_Report_2009-11-03.pdf
- Delnicki D, Reinecke KJ. 1986. Mid-winter food use and body weights of mallards and wood ducks in Mississippi. *J Wildl Manag.* 50: 43-51.
- Deverel SJ, Ingram T, Leighton D. 2016. Present-day oxidative subsidence of organic soils and mitigation in the Sacramento–San Joaquin Delta, California, USA. *Hydrogeology J* 24(3):569-586. Available from: <https://link.springer.com/article/10.1007/s10040-016-1391-1>
- Devries JH, Brook RW, Howerter DW, Anderson MG. 2008. Effects of spring body condition and age on reproduction in mallards (*Anas platyrhynchos*). *The Auk* 125(3):618–628. doi:10.1525/auk.2008.07055
- Dybala KE, Reiter ME, Hickey CM, Shuford WD, Strum KM, Yarris GS. 2017. A bio-energetics approach to setting conservation objectives for non-breeding shorebirds in California's Central Valley. *San Franc Estuary Watershed Sci.* 15(1):Article 2. Available from: <https://escholarship.org/uc/item/1pd2q7sx>
- Euliss Jr NH, Harris SW. 1987. Feeding ecology of northern pintails and green-winged teal wintering in California. *J Wildl Manag.* 51:724-732.
- Fleming KK, Brasher MG, Humburg DD, Petrie MJ, Soulliere GJ. 2017. Derivation of regional, non-breeding duck population abundance objectives to inform conservation planning. North American Waterfowl Management Plan Science Support Team Technical Report 2017-01.
- Fleskes JP. 2012. Wetlands of the Central Valley of California and Klamath Basin. Pages 357-370 in Batzer D and Baldwin A, eds. *Wetland habitats of North America: ecology and conservation concerns*. University of California Press. Berkeley.
- Fleskes JP, Halstead BJ, Casazza ML, Coates PS, Kohl JD, Skalos DA. 2012. Waste rice seed in conventional and stripper-head harvested fields in California: implications for wintering waterfowl. *J Fish Wildl Manag.* 3:266–275. doi: 10.3996/022012-JFWM-014
- Fleskes JP, Yee JL. 2007. Waterfowl distribution and abundance during spring migration in Southern Oregon and Northeastern California. *West N Am Nat.* 67(3):409-428. doi: 10.3398/1527-0904(2007)67[409:WDAADS]2.0.CO;2
- Fleskes JP, Yee JL, Casazza ML, Miller MR, Takekawa JY, Orthmeyer DL. 2005. Waterfowl distribution, movements, and habitat use relative to recent habitat changes in the Central Valley of California: A cooperative project to investigate impacts of the Central Valley Joint Venture and changing agricultural practices on the ecology of wintering waterfowl. Final Report. U.S. Geological Survey-Western Ecological Research Center, Dixon Field Station, Dixon, CA.
- Gilmer DS, Miller MR, Bauer RD, LeDonne JR. 1982. California's Central Valley wintering waterfowl: Concerns and challenges. U.S. Fish & Wildlife Publications. 41. Available from: <http://digitalcommons.unl.edu/usfwpubs/41>
- Guillemain M, Elmerberg J, Arzel C, Johnson AR, Simon G. 2007. The income–capital breeding dichotomy revisited: late winter body condition is related to breeding success in an income breeder. *IBIS* 150:172-176.
- Heitmeyer ME. 2006. The Importance of winter floods to mallards in the Mississippi Alluvial Valley. *J Wildl Manag.* 70:101-110. doi: 10.2193/0022-541X(2006)70[101:TIOWFT]2.0.CO;2
- Heitmeyer ME, Connelly DP, Pederson RL. 1989. The Central, Imperial and Coachella Valleys of California. Pages 475–505 in Smith LM, Pederson RL, Kaminski RM, eds. *Habitat management for migrating and wintering waterfowl in North America*. Texas Tech University Press, Lubbock.
- Heitmeyer ME, Fredrickson LH. 1981. Do wetland conditions in the Mississippi Delta hardwoods influence mallard recruitment? *Transactions of the North American Wildlife and Natural Resources Conference* 46:44-57.
- Kaminski RM, Gluesing EA. 1987. Density and habitat related recruitment in mallards. *J Wildl Manag.* 51:141-148.
- Koneff M. 2003. Derivation of regional waterfowl planning objectives for North American Waterfowl Management Plan continental population objectives. Unpublished report.
- Krapu GL, Brandt DA, Cox Jr RR. 2004. Less waste corn, more land in soybeans, and the switch to genetically modified crops: trends with important implications to wildlife management. *Wildl Soc Bull.* 32(1):127-136.
- Matthews LJH. 2019. Changing post-harvest practices, impacts on waste grain availability, and grower's perspectives: A study of rice and corn fields for wintering waterfowl in the Central Valley, Master's thesis, University of California, Davis, CA.
- Miller MR. 1987. Fall and winter foods of northern pintails in the Sacramento Valley, California. *J Wildl Manag* 51:405–414.
- Miller MR, Eadie JM. 2006. The allometric relationship between resting metabolic rate and body mass in wild waterfowl (Anatidae) and an application to estimation of winter habitat requirements. *Condor* 108:166–177.
- Miller MR, Newton WE. 1999. Population energetics of northern pintails in the Sacramento Valley, California. *J Wildl Manag.* 63:1222-1238.
- Moon JA, Haukos DA. 2006. Survival of female northern pintails wintering in the Playa Lakes Region of Texas. *J Wildl Manag.* 70:777–783.
- Moon JA, Haukos DA, Smith LM. 2007. Declining body condition of northern pintails wintering in the Playa Lakes region. *J Wildl Manag.* 71:218-221.
- [NAWMP] North American Waterfowl Management Plan. 2012. North American Waterfowl Management Plan 2012: people conserving waterfowl and wetlands. North American Waterfowl Management Plan. Available from: <https://www.fws.gov/birds/management/bird-management-plans/north-american-waterfowl-management-plan.php>
- Naylor LW. 2002. Evaluating moist-soil seed production and management in Central Valley wetlands to determine habitat needs for waterfowl, Master's thesis, University of California, Davis, CA.

- Olson SM, Compiler. 2019. Pacific Flyway data book, 2019. U.S. Department of Interior, Fish and Wildlife Service, Division of Migratory Bird Management, Vancouver, Washington. Available from: <https://www.fws.gov/migratorybirds/pdf/surveys-and-data/DataBooks/PacificFlywayDatabook.pdf>
- Petrie MJ, Brasher M, James D. 2014. Estimating the biological and economic contributions that rice habitats make in support of North American waterfowl. A Report to the Rice Foundation from Ducks Unlimited Inc. Rancho Cordova, CA.
- Petrie MJ, Brasher MG, Soulliere GJ, Tirpak JM, Pool DB, Reker RR. 2011. Guidelines for establishing Joint Venture waterfowl population abundance objectives. North American Waterfowl Management Plan Science Support Team Technical Report, 3–10 (see Supplemental Material, Reference S6). Available from: http://www.fwspubs.org/doi/suppl/10.3996/072014-JFWM-051/suppl_file/072014-jfwm-051.s6.pdf
- Petrie MJ, Fleskes JP, Wolder MA, Isola CR, Yarris GS, Skalos DA. 2016. Potential effects of drought on carrying capacity for wintering waterfowl in the Central Valley of California. *J Fish Wildl Manag.* 7:408. Available from: <https://www.fwspubs.org/doi/pdf/10.3996/082015-JFWM-082>
- Petrik K, Fehringer D, Weverko A. 2014. Mapping seasonal managed and semi-permanent wetlands in the Central Valley of California. Final Report to the Central Valley Joint Venture. Ducks Unlimited, Inc. Rancho Cordova, CA.
- Raquel A. 2017. Population trends and habitat selection of sandhill cranes and large waterfowl on Staten Island with management recommendations. 2017 Annual Report. Unpublished report.
- Raveling DG, Heitmeyer ME. 1989. Relationships of population size and recruitment of pintails to habitat conditions and harvest. *J Wildl Manag.* 53:1088-1103.
- Reinecke KJ, Loesch CR. 1996. Integrating research and management to conserve wildfowl (Anatidae) and wetlands in the Mississippi Alluvial Valley, USA. *Gibier Faune Sauvage, Game Wildfowl* 13:927-940. Available from: <https://www.semanticscholar.org/paper/Integrating-research-and-management-to-protect-and-Reinecke-Loesch/ee49ab300638d00dd1806ffef164e85e-8a1accb9>
- Shaskey L. 2016. Population trends, habitat selection and food availability for sandhill cranes and large waterfowl on Staten Island and associated management recommendations. 2016 Annual Report. Unpublished report.
- Sherfy MH. 1999. Nutritional value and management of waterfowl and shorebird foods in Atlantic Coastal moist-soil impoundments, PhD dissertation, Virginia Polytechnic Institute and State University, Blacksburg, VA.
- Skalos DA. 2012. Evaluating body condition and predicting lipid mass of wintering Pacific greater white-fronted geese (*Anser albifrons frontalis*), Master's thesis, University of California, Davis, CA.
- Thomas, DR. 2004. Assessment of waterfowl body condition to evaluate the effectiveness of the Central Valley Joint Venture, Master's Thesis, University of California, Davis, CA.
- [USBR et al.] U.S. Bureau of Reclamation, U.S. Fish and Wildlife Service, California Department of Fish and Wildlife. 2013. Suisun Marsh habitat management, preservation, and restoration plan. May 2013.
- [USDA] U.S. Department of Agriculture. 2014. National Agricultural Statistics Service. Available from: <https://quickstats.nass.usda.gov/>
- [USDA] U.S. Department of Agriculture. 2015. National Agricultural Statistics Service. California crops statistics. Available from: <http://quickstats.nass.usda.gov/>
- [USFWS] U.S. Fish and Wildlife Service. 2000. Central Valley wetlands water supply investigations. CVPIA 3406 (d) (6) (A, B). A Report to Congress. Final Report. December 2000.
- [USFWS] U.S. Fish and Wildlife Service. 2014. Waterfowl population status, 2014. Washington, D.C.: U.S. Department of the Interior (see Supplemental Material, Reference S8).
- Williams CK, Dugger BD, Brasher MG, Coluccy JM, Cramer DM, Eadie JM, Gray M.J, Hagy HM, Livolsi M, McWilliams SR, Petrie M, Soulliere GJ, Tirpak JM, Webb EB. 2014. Estimating habitat carrying capacity for migrating and wintering waterfowl: considerations, pitfalls and improvements. *Wildfowl* 4:407–435.

NOTES

- Chappell S. 2019. Executive Director, Suisun Resource Conservation District. Discussions with Dr. Mark Petrie, Director of Conservation Planning, Ducks Unlimited, Inc. regarding the Suisun planning region's irrigation water supplies.
- Fehringer D. 2016. Ducks Unlimited, Inc. Email communication to CVJV regarding estimates of wetland acres restored between 2009 and 2015 in the Central Valley.
- Fehringer D. 2019. Ducks Unlimited, Inc. Estimated area of managed seasonal wetlands in the Central Valley restored between 2009 and 2015. Unpublished data.
- Getz V. 2019. Manager, Conservation Programs, Ducks Unlimited, Inc. Discussions with Dr. Mark Petrie, Director of Conservation Planning, Ducks Unlimited, Inc. regarding private rice habitat protected through conservation easements in the Sacramento planning region.
- Olson B. 2019. California Department of Fish and Wildlife. Email communication to CVJV regarding estimates of rice grown under contract by local farmers on state wildlife areas in the Central Valley.
- Skalos D. 2019. Waterfowl Program at the California Department of Fish and Wildlife. Discussions with Dr. Mark Petrie, Director of Conservation Planning, Ducks Unlimited, Inc. regarding salinity reducing current levels of food production for ducks.



1

BREEDING WATERFOWL

8



2



3

CHAPTER SUMMARY

The Central Valley hosts hundreds of thousands of breeding ducks in the spring and summer. The Central Valley Joint Venture applies the goals of the North American Waterfowl Management Plan to create landscape conditions that support abundant and resilient populations of these duck species.

This chapter describes the current status and declining population trends of the three most common nesting duck species in the Valley (mallard, gadwall and cinnamon teal); the landscape changes and limiting factors these species face; and the conservation objectives for the restoration and management of wetlands flooded during the spring and summer breeding season and adjacent upland nesting habitat needed by these species.

The Conservation Delivery chapter in Section I integrates the breeding waterfowl habitat objectives with the habitat objectives for non-breeding waterfowl and other bird groups in the Implementation Plan to present total habitat needs in the Central Valley. The Conservation Delivery chapter then describes conservation actions for achieving these integrated habitat objectives.

LONG-TERM HABITAT OBJECTIVES: WHAT'S NEEDED?

SEMI-PERMANENT WETLANDS:
44,000 ACRES TOTAL
= 21,000 ADDITIONAL ACRES

UPLAND NESTING HABITAT:
177,000 ACRES TOTAL
(Current acreage is not known)

INCLUDES 54,000 ACRES IN THE RICE-GROWING REGION OF THE SACRAMENTO VALLEY

HABITAT TYPE

Breeding ducks in the Central Valley require upland and wetland habitats, in proximity to each other. Upland habitats, which are used for nesting, include natural or planted uplands, pasture and certain annual crops (growing or idle). Wetland ponds and planted rice fields that are used for brood rearing contain water in the spring and summer. Post-breeding adults also need wetlands that remain flooded until late summer, during their flightless wing-molt period. Semi-permanent wetlands provide the needed spring and summer habitat and are the most practical option for most land managers.

SUCCESS STORY: Partnerships Enhancing Nesting Habitat on the Conaway Ranch

The importance of upland nesting and brood rearing habitats for California's resident mallard, gadwall and cinnamon teal populations has been well documented and has served as the basis for the California Waterfowl Association's Conservation Programs for the past several decades. In the Yolo Basin, for example, California Waterfowl partnered with federal and state agencies to acquire several thousand acres of wildlife-friendly farming conservation easements and to restore hundreds of acres of wetlands and uplands on the Conaway Ranch.

Upland habitats on the Conaway Ranch are also critically important to tricolored blackbirds, giant garter snakes and a suite of other wildlife species. The Conaway Ranch, owned by a private preservation group, is managed for a mixture of uses including cattle ranching, wildlife friendly-farming, conservation, resource management, flood control and integrated water management.

BIRD SPECIES INCLUDE:

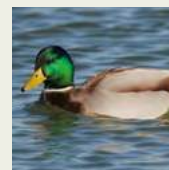

Mallard*



Gadwall*



Cinnamon teal*

*Images: Tom Grey

(1) Cinnamon teal - Jennifer Barton (2) Breeding duck habitat - Dan Skalos (3) Mallards - Mike Peters

INTRODUCTION

Conservation planning for waterfowl and wetland management in the Central Valley has its origins in the North American Waterfowl Management Plan (NAWMP 2012) and has largely focused on meeting the habitat needs of wintering and migrating waterfowl (ducks, geese and swans). Since its formation in 1988, the Central Valley Joint Venture (CVJV) and its partners have restored thousands of acres of managed wetlands in an effort to meet those needs. While wintering ducks, geese and swans have benefitted under this management paradigm, locally nesting duck species have declined substantially, and their populations are at or near all-time lows (Skalos and Weaver 2019). This chapter addresses the CVJV's objectives for protecting and restoring habitat to support populations of breeding ducks in the Central Valley. Breeding goose populations are robust, and no native swans breed in the Central Valley.

More than 90 percent of restored wetlands in the Central Valley are managed seasonally for waterfowl, along with shorebirds and other waterbirds, during the fall and winter (Petrik et al. 2014). Improved wetland habitat, combined with current agricultural practices (predominantly winter-flooded rice), has benefitted migrating and wintering duck populations in several ways, particularly increased body condition, increased survival and shorter observed flight distances (Ackerman et al. 2006; Fleskes et al. 2007; Thomas 2009; Fleskes et al. 2016; McDuie et al. 2019).

Hundreds of thousands of wintering ducks remain in the Central Valley during the spring and summer to breed. The three most common nesting species are mallards (*Anas platyrhynchos*), gadwall (*Mareca strepera*) and cinnamon teal (*Spatula cyanoptera*). Ducks have additional habitat requirements during the breeding season to what they require in winter or during migration. These requirements include seasonal and semi-permanent wetlands that are flooded during the spring and summer, to serve as foraging habitat for hens and their broods, and adjacent or nearby upland habitats with suitable vegetation for nesting (Baldassarre and Bolen 2006). Post-breeding and resident non-breeding ducks also have specific habitat requirements. During wing molt, when they are flightless for three to four weeks in late summer, ducks

rely on semi-permanent or permanent wetlands: these types of wetlands are not prone to drying up in the summer and contain emergent (above-water) perennial herbaceous plants that provide protective cover (Yarris et al. 1994; Kohl 2019).

These additional habitat needs for breeding ducks pose challenges for managers of public and private wetlands in the Central Valley and sometimes require creative conservation strategies that benefit both breeding and non-breeding waterfowl. Providing upland and spring- and summer-flooded wetland habitats in addition to traditional wintering habitat is paramount for sustaining local duck populations. Unfortunately, negative trends in Central Valley breeding duck populations indicate these habitats are not currently available in sufficient quantity and quality to maintain populations. Mallards, the most abundant nesting duck in the Central Valley, are 28 percent below their long-term average (LTA) statewide (Skalos and Weaver 2019) and 44 percent below their LTA in the Central Valley.

Duck hunters play an important role in protecting wetland habitat (see the Human Dimensions chapter in this Implementation Plan). The contribution of locally breeding ducks to hunter harvest in California is significant. Reversing the negative population trend for ducks is therefore important for maintaining engagement from duck hunters, engaging the next generation of hunters, and, in turn, maintaining the habitat in which duck hunters continue to invest. Importantly, 60 percent of the hunter-harvested mallards, 53 percent of the harvested cinnamon teal and 49 percent of the harvested gadwall in California are resident and are hatched and raised locally (de Sobrino et al. 2017). Mallards (20 percent), gadwall (five percent) and cinnamon teal (three percent) combined make up a considerable portion of hunter-harvested ducks in California (mean percent from 1965-2018; Olson 2019; Trost and Drut 2003). These data indicate that local duck production and resident duck populations have a direct impact on hunter success, as well as on the non-hunting public who enjoy waterfowl viewing.

In 2008, the U.S. Fish and Wildlife Service (USFWS) recognized three separate stocks of breeding mallards: eastern, mid-continent and western, each with its own adaptive harvest management (AHM) strategy (USFWS 2008; Yparaguirre et al. 2014). California mallards are now recognized and managed as a component of the western mallard population. Mallards produced within the CVJV's planning regions contribute significantly to and comprise about 17 percent (2010-2017) of the western mallard stock. The western mallard AHM strategy is an important element of Pacific Flyway management, as the status of mallards in western states and

provinces collectively determines the hunting regulations and opportunities there. Improving habitat conditions for locally nesting mallards and other ducks to reverse the population declines contributes to this obligation.

The North American Waterfowl Management Plan Assessment Steering Committee (ASC 2007) reviewed past Joint Venture planning efforts nationwide and identified the actions needed to produce a consistent and cohesive set of habitat objectives across the North American landscape. Those actions, which are consistent with Strategic Habitat Conservation, include Biological Planning, Conservation Design and Conservation Delivery. The CVJV adopted these planning actions to develop the current Implementation Plan (“the Plan”). Strategic Habitat Conservation and these planning actions are explained in more detail in the Non-Breeding Waterfowl chapter and the Planning for Conservation Success chapter.

CONSERVATION GOAL

The Central Valley Joint Venture’s long-term goal for waterfowl is to guide regional efforts to create landscape conditions necessary to support abundant and resilient breeding and non-breeding duck populations in the Central Valley at levels that support hunting and other uses, consistent with the North American Waterfowl Management Plan.



Gadwall breeding pair - Mike Peters

BIOLOGICAL PLANNING: The Science Behind CVJV Conservation Objectives

Planning Regions

Planning regions represent the geographic scale at which the CVJV establishes conservation objectives for breeding waterfowl. The CVJV has two distinct focus areas, the Primary Focus Area (the Valley floor, including the Carrizo Plain) and the Secondary Focus Area (the surrounding foothills/mountains; Figure 8.1). The Central Valley’s nine drainage basins within the Primary Focus Area served as the planning units in the 2006 CVJV Implementation Plan (CVJV 2006) (see individual basins in Figure 4.1.1, in the Environmental, Social and Political Landscape: Background subchapter). However, this 2020 Plan combines some adjacent drainage basins into larger planning areas, resulting in five planning regions. The larger extent of planning regions (versus drainage basins) allows increased flexibility for placement of wetland restoration and agricultural easements.

The Primary Focus Area of the Central Valley is the emphasis of planning for breeding waterfowl for several reasons. Most importantly, annual population surveys indicate the Valley floor supports the majority of the breeding ducks within the CVJV boundary. The majority of natural and managed wetlands and agriculture that is complementary to breeding ducks (e.g., winter wheat and rice) occur on the Valley floor. In addition, most of the existing wetlands in this area are actively managed, thus, strategies expected to improve breeding and post-breeding success can be developed and implemented there. In this chapter, unless otherwise indicated, “the Valley” refers to the CVJV’s Primary Focus Area.

The CVJV did not develop population and habitat objectives for breeding waterfowl in the CVJV Secondary Focus Area. The mountain ranges and

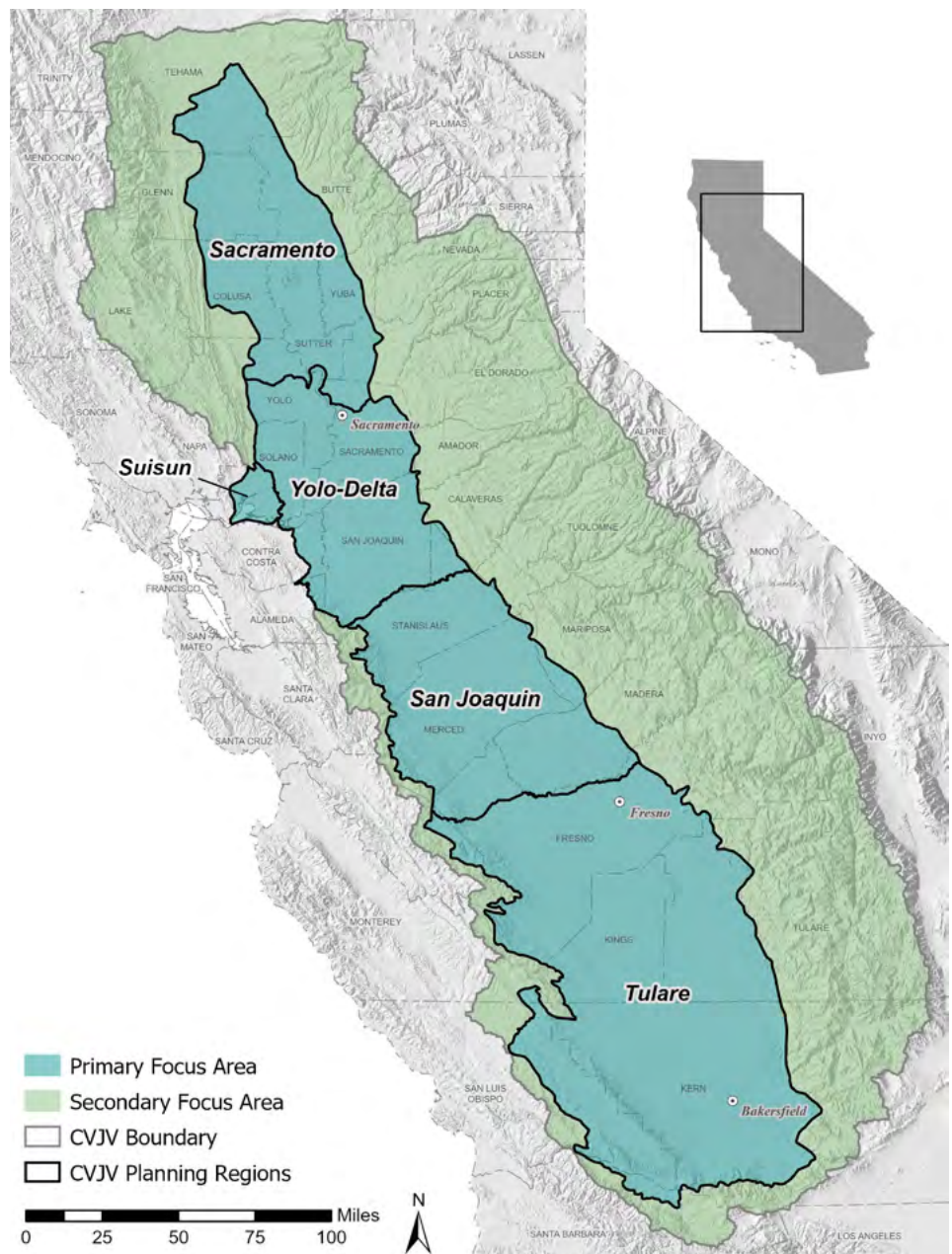

FIGURE 8.1 Central Valley Joint Venture perimeter and Primary Focus Area, divided into five planning regions.

foothills included in the Secondary Focus Area are expansive and include considerable, but dispersed, habitat for nesting ducks. The main habitats in these areas include lakes, rivers and their tributaries, isolated emergent and forested wetlands and human-made stock ponds. The number of ducks and geese inhabiting these areas is un-

known, as breeding population surveys are not conducted there. Habitat quality and breeding densities of dabbling ducks are expected to be lower, but perhaps with less variability, than in the Primary Focus Area. Many of the same disturbances and activities seen in the Primary Focus Area have altered these landscapes, but human population

densities are lower and modifications to the habitat are less severe. However, the human population continues to grow, and the extent of urban development and perennial crops continue to expand and to degrade habitats (Cameron et al. 2014; Sleeter et al. 2017; Pandolfino and Handel 2018).

Focal Species

At least 10 species of waterfowl breed in the Central Valley (Skalos and Weaver 2019). Guidelines for selecting CVJV focal species were based on the following criteria:

- The population exists at relatively high abundance in the Primary Focus Area.
- Regional abundance is of high importance to statewide population size and hunter harvest.
- Factors limiting reproduction are relatively well understood, at least at the local scale.
- Population surveys using accepted protocol are conducted to monitor status.

Based on these criteria, the CVJV selected mallards, gadwall and cinnamon teal to use as focal species to direct conservation planning. The combined populations of these three species account for about 85 percent of the breeding ducks in the Primary Focus Area (Skalos and Weaver 2019) and likely represent the habitat needs of the entire dabbling duck guild. Additionally, harvest information indicates that 60 percent of mallards, 49 percent of gadwall and 53 percent of cinnamon teal originate from California breeding stock (de Sobrino et al. 2017). Therefore, maintaining healthy breeding populations of these species for ecological and recreational purposes is a key priority for the CVJV.

Seven other breeding duck species did not meet the focal species criteria. Among dabbling ducks, northern pintails (*Anas acuta*) and northern shovelers (*Spatula clypeata*) were excluded because their breeding populations are small and contributions to the large regional winter population are minor. Wood ducks (*Aix sponsa*) are common local nesters but were excluded because breeding duck surveys do not adequately assess their population size or trends (due to poor detection in their preferred riparian habitat).

Four species of diving ducks also breed in the Central Valley but were not considered because their breeding populations are small relative to wintering populations. They include ruddy ducks (*Oxyura jamaicensis*), redheads (*Aythya americana*),

hooded mergansers (*Lophodytes cucullatus*) and common mergansers (*Mergus merganser*). The breeding habitat needs of these species are partially addressed by the objectives in this and other chapters of the Plan where riparian, wetland and upland habitat conservation is prescribed. Breeding redheads are considered a California Bird Species of Special Concern (Beedy and Deuel 2008) and their habitat needs and distribution are given further consideration in the At-Risk Bird Species chapter.

Canada geese (*Branta canadensis*) were excluded from the CVJV's breeding waterfowl conservation objectives because their breeding population index is already well above the long-term average (Skalos and Weaver 2019) and they do not appear to be habitat-limited. In fact, they are considered a nuisance in many areas of California, including parts of the Central Valley (California Code of Regulations, Title 14, Subdivision 2, Chapter 7, 503). Canada geese breeding in the Central Valley are managed using a harvest strategy approved by the Pacific Flyway Council's subcommittee on Pacific Population of Western Canada Geese (Pacific Flyway Council 2000). No other species of goose, and no native swans, breed in the Valley.



Ruddy duck - Mike Peters

Current Population Status and Trends

The Primary Focus Area of the CVJV is the major breeding area for waterfowl in California and it accounts for about 70 percent of all breeding ducks in the state. Northeastern California, which is part of the Intermountain West Joint Venture, also contributes markedly to populations of breeding ducks statewide (Skalos and Weaver 2019). Other areas (e.g., coastal regions and southern California) are thought to support minor populations and are not surveyed at this time (Sauer et al. 2017). The CVJV Secondary Focus Area (especially the foothills region) may contribute a significant share of habitat during wet years; however, no assessment of the overall contribution of this region has been conducted.

The California Department of Fish and Wildlife (CDFW) estimates waterfowl breeding populations in the Valley in April based on results from the annual breeding waterfowl survey (Skalos and Weaver 2019). The annual survey has been conducted in the state since 1948, but the methodology was redesigned and updated in 1991 to be more consistent with continental surveys (Zezulak et al. 1991; Skalos and Weaver 2019). This survey has been ongoing using the new design since 1992 and is part of the regulation guidance under the USFWS adaptive harvest management (AHM) plan for western mallards (USFWS 2019b). Consolidating the nine basins into five planning regions made it possible to derive regional population estimates (D. Skalos, unpublished data, 2019, see “Notes”). Survey data were extrapolated to suitable habitat in un-surveyed areas and to estimate the breeding duck popula-

tion for the Primary Focus Area as a whole and for each planning region. Changes in breeding duck population abundance and other trends were assessed for the Primary Focus Area and for each of the planning regions using data from the revised surveys.

Current duck populations were calculated using survey data from the past three years (2017-2019). The average of these three years’ results was used to reflect the “current” population, rather than just one year, to account for yearly fluctuations inherent to duck populations. Long-term average (LTA) populations represent the average of survey data between 1992, when the survey methodology was updated, and 2019, the latest data available.

Focal species distribution

The Sacramento planning region is historically the major breeding region for mallards in the Valley, comprising an LTA of 38 percent of the Valley’s total population of breeding mallards (Table 8.1). In recent years, the proportion of mallards in this region has declined to about 25 percent; the region now ranks third in importance for mallards behind the Yolo-Delta and San Joaquin planning regions (Table 8.1).

Gadwall and cinnamon teal population estimates are more variable. Compared to mallards, these species tend to use areas with less agriculture, more natural habitat and more arid conditions. For gadwall, habitat in the Tulare region supports the greatest portion of the population, with an LTA of

PLANNING REGION	MALLARD		GADWALL		CINNAMON TEAL		TOTAL ^a	
	CURRENT ^b	LTA ^c	CURRENT ^b	LTA ^c	CURRENT ^b	LTA ^c	CURRENT ^b	LTA ^c
Sacramento	25.1%	38.3%	14.5%	16.8%	14.3%	19.0%	22.7%	34.5%
Suisun	9.9%	6.8%	23.2%	21.1%	16.9%	7.9%	12.4%	8.4%
Yolo-Delta	26.3%	22.4%	16.0%	10.7%	11.6%	12.2%	23.7%	20.4%
San Joaquin	25.3%	20.2%	18.8%	24.4%	26.4%	31.1%	24.4%	21.5%
Tulare	13.4%	12.3%	27.5%	27.0%	30.8%	29.8%	16.8%	15.2%
	100%	100%	100%	100%	100%	100%	100%	100%

^a Total of the three focal species.

^b Current population is defined as the mean of the latest three years of breeding population surveys, 2017-2019.

^c LTA (long-term average) is defined as the mean of the 1992-2019 breeding population surveys.

TABLE 8.1 Current and long-term average (LTA) distribution of duck focal species’ breeding populations in the Primary Focus Area of the Central Valley. (Sums may not be exact, due to rounding in original data.)

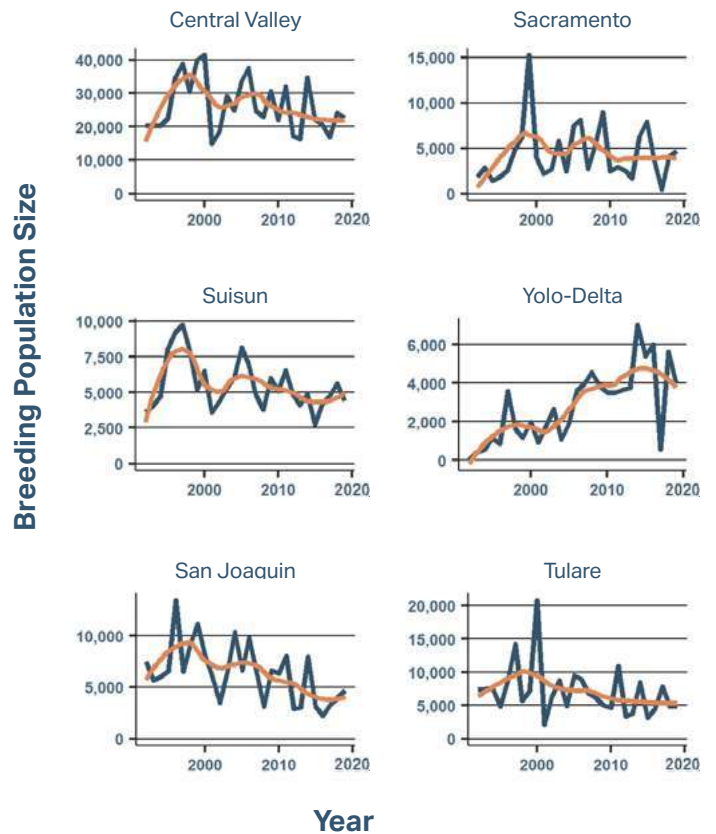
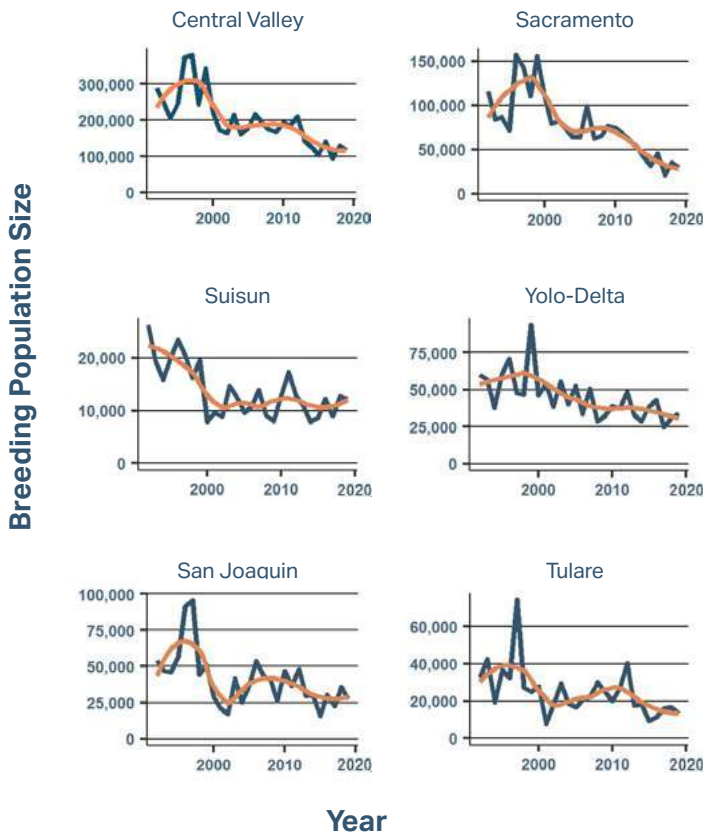

FIGURE 8.2 Breeding mallard population estimates for the CVJV Primary Focus Area and five planning regions, 1992-2019 (orange trend line smoothed using Loess regression with span of 0.50).

FIGURE 8.3 Breeding gadwall population estimates for the CVJV Primary Focus Area and five planning regions, 1992-2019 (orange trend line smoothed using Loess regression with span of 0.50).

about 27 percent of the Valley’s total population (Table 8.1). Breeding gadwall are found in slightly lower numbers in the San Joaquin and Suisun planning regions. The Sacramento and Yolo-Delta planning regions typically contain a smaller portion of breeding gadwall. Cinnamon teal tend to be distributed mostly in the southern portion of the Central Valley, including the San Joaquin region with an LTA of 31 percent and the Tulare region with an LTA of 30 percent (Table 8.1).

and in each planning region. Figures 8.2, 8.3 and 8.4 depict the population survey data for the three species graphically, showing high and low years and long-term trends.

Note that planning regions are not the same size, so the proportion of a population does not necessarily reflect a region’s importance or the quality of available habitat in a region. For example, when standardized by planning region area, Suisun represents the highest densities of mallards, with a long-term average of 84 ducks per square mile, followed by Sacramento at 20 per square mile. Likewise, in the late 1980s, Suisun had the highest pair and nest densities (McLandress et al. 1996).

The current population of breeding mallards within the CVJV boundary is about 113,000 individuals, compared to a maximum population of 386,000 individuals observed in 1997 and a minimum of 104,000 individuals observed in 2015 (Figure 8.2). Overall, mallards are currently 44 percent below the LTA. The most significant disparity occurs in the Sacramento Valley, where the current three-year average is 63 percent below the LTA. Breeding mallard abundance is 34 percent below the LTA in Yolo-Delta region, 30 percent below in the San Joaquin region, and 39 percent below the LTA in Tulare. The mallard population decline in Suisun is less severe than for other planning regions. Although mallard populations are still 18 percent below the LTA in Suisun Marsh, the trends in this region have improved in recent years (Figure 8.2).

Current status of focal species

Table 8.2 shows population numbers, objectives and trends for the three focal species, in the Central Valley as a whole

The current population of gadwall within the CVJV is 21,000 individuals, compared to a maximum of 41,000 observed in

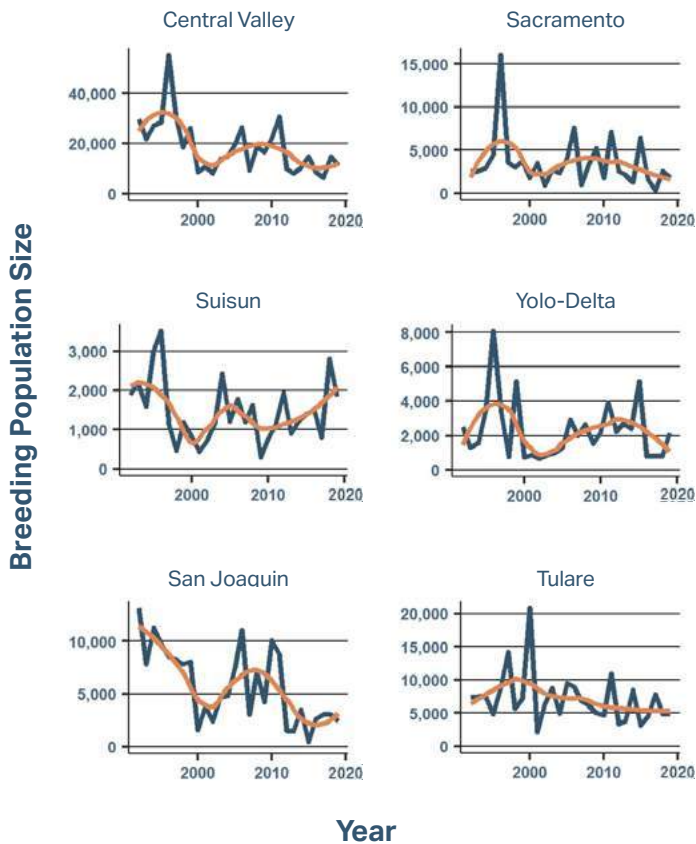

FIGURE 8.4 Breeding cinnamon teal population estimates for the CVJV Primary Focus Area and five planning regions, 1992-2019 (orange trend line smoothed using Loess regression with span of 0.50).

2000 and a minimum of 14,700 observed in 2001 (Figure 8.3). Overall, breeding gadwall have not declined as precipitously as mallards in the Valley but remain 19 percent below their LTA. Gadwall populations were once on the increase in the Sacramento region but began to decline in 2006 and are now 30 percent below the LTA in this region. In the Yolo-Delta region, gadwall populations have continually increased since breeding surveys began in 1992 and are currently 21 percent above the LTA in this area. In the Suisun planning region, gadwall are 11 percent below the LTA and, similar to mallards, are trending upwards. Because mallard populations are declining faster than gadwall populations, the percentage of gadwall nests in Suisun Marsh has increased in recent years from, 17 percent of monitored nests historically (Ackerman et al. 2014) to 48 percent of nests recently (J. Ackerman, unpublished data, 2019a, see “Notes”). Gadwall population estimates are 37 percent and 18 percent below the LTA in the San Joaquin and Tulare planning regions, respectively.

The current population estimate for cinnamon teal is about 10,800 individuals, which is 42 percent below the LTA.

The cinnamon teal breeding population has ranged from a minimum of 6,400 observed in 2017 and a maximum of about 55,500 observed in 1996 (Figure 8.4). By region, population levels are 56 percent below the LTA in the Sacramento, 45 percent below in Yolo-Delta, 51 percent below in San Joaquin, and 40 percent below in Tulare. Cinnamon teal in Suisun have been increasing in recent years and are currently 24 percent above the LTA, although the overall population size of cinnamon teal in Suisun is relatively small.

Population objectives

Background and NAWMP Revision

When the NAWMP was revised in 2012, it provided guidance to Joint Ventures that allowed differing approaches to developing population objectives for their respective regions. Considering the dynamic nature of duck populations, the waterfowl conservation community recommended using a two-part objective to account for the natural variation when establishing population abundance objectives: 1) As the baseline, maintain LTA population levels (50th percentile) for mallards, the primary duck species, and 2) recognizing that populations will be well above the LTA in some years, periodically achieve an 80th percentile abundance level (highest 20 percent of years) for total ducks (NAWMP 2014).

The dual objectives were intended to be complimentary and represent the dynamic nature of waterfowl habitats and populations. Yet NAWMP provided little guidance on the appropriate application or interpretation of these objectives. Furthermore, breeding duck population objectives from the NAWMP cannot be applied directly to the CVJV region because it falls outside the traditional survey area covered by the Waterfowl Breeding Population and Habitat Survey (USFWS 2019a). However, a similar objective-setting process, with slight modifications, was applied to the Central Valley using breeding duck survey information from California.

Revising the Population Objectives

The annual CDFW waterfowl breeding population survey uses fixed and repeated survey transect lines to sample the Central Valley and provide an index of duck abundance. Survey transect data were extrapolated to suitable habitat in areas not surveyed, to estimate the total breeding duck population for the CVJV Primary Focus Area and for each planning region. Using these data, the CVJV calculated the current population abundance, the LTA abundance, the 90th percentile of the LTA abundance (meaning that 90 percent of the years are at or below this population size), and the difference between the current population, the LTA, and 90th percentile of the LTA (Table 8.2).

SPECIES	POPULATION MEASURES				POPULATION TREND	
PLANNING REGION	CURRENT ^a	MINIMUM ^b	OBJECTIVE ^c	DEFICIT ^d	vs. MINIMUM ^b	vs. OBJECTIVE ^c
Mallard (<i>Anas platyrhynchos</i>)						
Sacramento	28,309	77,148	117,042	88,733	-63%	-76%
Suisun	11,223	13,618	20,660	9,437	-18%	-46%
Yolo-Delta	29,675	45,048	68,343	38,668	-34%	-57%
San Joaquin	28,568	40,778	61,865	33,297	-30%	-54%
Tulare	15,200	24,776	37,587	22,387	-39%	-60%
CVJV Total	112,975	201,369	305,497	192,522	-44%	-63%
Gadwall (<i>Mareca strepera</i>)						
Sacramento	3,088	4,388	6,335	3,248	-30%	-51%
Suisun	4,919	5,542	8,000	3,081	-11%	-39%
Yolo-Delta	3,404	2,807	4,052	649	+21%	-16%
San Joaquin	3,989	6,379	9,208	5,219	-37%	-57%
Tulare	5,837	7,083	10,226	4,388	-18%	-43%
CVJV Total	21,237	26,199	37,822	16,585	-19%	-33%
Cinnamon teal (<i>Spatula cyanoptera</i>)						
Sacramento	1,545	3,521	5,669	4,124	-56%	-73%
Suisun	1,817	1,460	2,351	535	+24%	-23%
Yolo-Delta	1,252	2,268	3,652	2,399	-45%	-66%
San Joaquin	2,852	5,775	9,299	6,447	-51%	-69%
Tulare	3,324	5,532	8,907	5,583	-40%	-63%
CVJV Total	10,790	18,556	29,878	19,088	-42%	-64%
Total (focal species)						
Sacramento	32,942	85,058	129,046	96,105	-61%	-74%
Suisun	17,959	20,620	31,012	13,053	-13%	-42%
Yolo-Delta	34,331	50,123	76,047	41,716	-32%	-55%
San Joaquin	35,409	52,932	80,372	44,963	-33%	-56%
Tulare	24,361	37,391	56,720	32,359	-35%	-57%
CVJV Total	145,002	246,124	373,197	228,195	-41%	-61%

^a Current population is defined as the mean of the latest three years of population surveys, 2017-2019.

^b Minimum CVJV population objective, defined as the long-term average (LTA) of the 1992-2019 breeding population surveys.

^c CVJV population objective, defined as the 90th percentile of the LTA of the 1992-2019 breeding population surveys.

^d Population deficit, the difference between the population objective and the current population.

TABLE 8.2 Population abundance, population objectives and population trends for breeding duck focal species, in the Valley as a whole and by planning region. (Sums may not be exact, due to rounding in original data.)



The CVJV used guidance from NAWMP (2014) to establish dual population objectives, but interpreted the guidance using available information for local waterfowl populations and habitat conditions. NAWMP objectives are based on the traditional survey area in the mid-continent United States and Canada, where estimates of total breeding ducks in recent years were above the LTA (USFWS 2019a). In contrast, the breeding duck populations in the Central Valley are well below their LTA and have been for several years (Table 8.2). Additionally, the LTA for mid-continent duck populations is based on surveys since 1955, so these data represent a wide range of breeding habitat conditions from a longer time period. Breeding duck surveys in the Central Valley have only been conducted since 1992, a period less than half as long as surveys in the traditional survey area. The CVJV considered these differences and other regional factors when applying NAWMP guidance to population objectives.

The CVJV did not consider the LTA of a rapidly declining population as an acceptable population objective for planning or even as a baseline population level. Rather, the CVJV interpreted the LTA as an absolute minimum acceptable level. The population dropping below this level will accelerate conservation efforts for breeding ducks. Further, the CVJV interpreted the 90th percentile of the LTA as the population objective to strive for every year, rather than the population level that would occasionally be achieved due to fluctuations when conditions are optimal. The California duck breeding population has exceeded the 90th percentile of the LTA during 10 percent of the years since 1992 (almost 30 years). This information indicates that landscape conditions capable of periodically providing breeding habitat above the 90th percentile level are achievable. For example, during the five-year period from 1995-1999, the mean population size for mallards was 317,685 birds, which is greater than the 90 percent of the LTA (305,497). Moreover, breeding duck populations historically far exceeded objectives proposed here; they declined as a result of the tremendous (more than 90 percent) wetland loss in the Central Valley in modern times (Frayner et al. 1989).

Breeding population objectives for each focal species for the CVJV and within each planning region were established using the above criteria (Table 8.2).

- The LTA of the breeding population for each species is considered the **minimum population objective**.
- The 90th percentile of the LTA is set as the **long-term population objective**.



Mallard pair - Mike Peters

Current Status Relative to Population Objectives

Current population estimates and 90th percentile abundance values were used to calculate abundance deficits for the three focal species across the CVJV Primary Focus Area and in each of the five planning regions. Abundance deficits are the long-term population objective minus the current population estimate. Based on abundance estimates for the CVJV Primary Focus Area as a whole, current populations for the three focal species total about 145,000 breeding ducks. Achieving the 90th percentile population abundance objectives for these three species requires an increase of 228,000 breeding ducks. This increase will require a 61 percent increase in the combined abundance of these three species. Furthermore, the combined population of the focal species is 41 percent below the minimum population objective (Table 8.2).

All three focal species currently have significant population deficits relative to their long-term objectives and all are below their minimum population objectives. Numerically, mallards have the largest population deficit: they are about 193,000 ducks (63 percent) below the Valley-wide objective. Mallards are well below their objectives in all planning regions, but the largest deficit is in the Sacramento planning region. Achieving the long-term population objective there (approximately 117,000 individuals) would require more than a fourfold increase in the current population (Table 8.2).

The population deficit for gadwall is less than for the other focal species, but still well below (33 percent) the Valley-wide long-term population objective of about 38,000 breeding

ducks. The population deficit for gadwall is more than 3,000 ducks below regional objectives in the Sacramento, Suisun, San Joaquin and Tulare planning regions (Table 8.2). In the Yolo-Delta planning region, breeding gadwall are closer to, but still below, population objectives.

Cinnamon teal have the largest deficit relative to their population objective; their current population of about 10,800 is 66 percent below the Valley-wide long-term objective of about 30,000 individuals. In all planning regions except Suisun, cinnamon teal are at least 60 percent below their population objective (Table 8.2). The largest population deficits for cinnamon teal are in the southern planning regions (San Joaquin and Tulare), which historically supported more than half the breeding ducks for this species. In the Suisun planning region, the cinnamon teal population is 24 percent above the minimum population level (the LTA), but still 23 percent below the long-term objective.

Life-Cycle Modeling and Limiting Factors

Biological models provide a means for effective conservation planning by translating population objectives into habitat objectives. The CVJV translated population objectives for non-breeding waterfowl into habitat objectives (as acres of foraging habitat), based on estimates of how much food energy will be needed by duck populations that have reached the population objectives (see the Non-Breeding Waterfowl chapter). Developing models for the breeding season is more complex, because waterfowl behavior and habitat requirements change depending on the stage of the life cycle (Johnson et al. 1992). Currently, there is no clear link between population objectives for breeding waterfowl and the amount and types of habitat needed in the Central Valley to support them.

Identifying population-limiting factors and understanding these factors' ecological relationships to habitat are essential when developing habitat objectives and conservation strategies. Vital rates (factors affecting population growth, such as nesting success and duckling survival rates) are available for breeding mallards in the Central Valley from several published and unpublished sources (CVJV 2006, Table 5-2; Feldheim et al. 2018). This information has improved researchers' knowledge of locally breeding ducks and simple demographic models have been developed (Oldenburger 2008). However, the understanding of factors influencing the population growth of locally nesting species in the Central Valley remains incomplete. Thus, the CVJV relied on both local data and published information from other regions to explore possible limiting factors and to develop habitat objectives.

There is convincing evidence that dabbling duck population growth is primarily influenced by habitat quality and quantity during the breeding season, and that it is most responsive to vital rate changes during this period.

Demographic models for mallards indicate that mortality outside of the breeding season (such as hen survival) can inhibit population growth in some areas (Hoekman et al. 2006), including California, but that various factors during the breeding season are more significant (Hoekman et al. 2002; Oldenburger 2008; Dugger et al. 2016). The breeding season vital rates most important to population growth include breeding propensity (the likelihood a hen will nest), nest success and duckling survival.

However, the non-breeding season also includes the annual wing molt, a potentially vulnerable period for adult ducks because they are flightless, have increased energetic demands, and have specific habitat needs that are limited in the Central Valley (Yarris et al. 1994; Fleskes et al. 2010; Kohl 2019).

The focal species included in this chapter are residents of California for most or all of the year and thus, they require habitat to fulfill their needs during their entire annual life-cycle. Habitat conditions during the non-breeding period have improved considerably since the formation of the CVJV. However, to increase the populations of focal species, it will be most effective to focus on habitats required during the breeding season, and to target the vital rates most likely to increase the production and survival of ducklings. In doing so, it is still important to recognize the cross-seasonal relationships in ducks between wintering habitats and survival and breeding success (Devries et al. 2008; Sedinger and Alisauskas 2014).

CONSERVATION DESIGN: How Much Conservation, of What Type, and Where?

Characterization of the Landscape

Breeding populations of all three focal species have declined throughout the Central Valley, indicating that factors acting at a landscape-level are likely involved. However, differing rates of decline among planning regions and among duck species indicate certain factors may be unique to each area. Nesting ducks rely on a wide variety of upland habitats, ranging from undisturbed grassland habitat to intensively farmed cropland. Some spatial and tabular data are available to evaluate upland trends, but a thorough analysis of changes in land cover types important to nesting ducks is currently lacking.

Spatial data and crop statistics are available to assess trends in agriculture, and some preliminary evaluations relative to breeding duck populations have been completed (D. Skalos, unpublished data, 2020; M. Cassazza, unpublished data, 2019, see “Notes”). Changes in the extent of managed wetlands in the Valley is well-documented by agencies and organizations involved in wetland protection and restoration (e.g., Petrik et al. 2014). However, wetland type and management (specifically, hydroperiod – the timing and duration of flooding – and the depth of flooding) is difficult to determine, so it is uncertain how much of each wetland habitat type is available during the breeding season in any given year.

The rural landscape in the Central Valley has changed dramatically since breeding waterfowl surveys were revised in 1992. Many changes, some of which are permanent, are having detrimental impacts on breeding waterfowl habitat. Urban development is expanding into rural areas in the Valley due to the lack of affordable housing in coastal areas, improving local economies and an increasing human population. The urban footprint in the CVJV Primary Focus Area has increased by 42 percent since 1992, from 680,000 acres to 970,000 acres (CDOC 2019).

Changes in cropping patterns have also been significant. Most noticeable has been the shift from annual crops to perennial crops, especially almonds (and other tree nuts), olives and vineyards (Coates et al. 2017). In 1992 there were about 650,000 acres of tree nuts planted in the CVJV planning area; today there are more than 2 million acres, an increase of more than 200 percent (USDA 2019b). Loss of annual crops and pasture is significant because annual crops are generally compatible with breeding ducks, whereas orchards and other perennial crops are not. For nesting ducks, the increases in orchards have come at the expense of annual crops such as small grains (wheat and barley, reduced by almost 70 percent) and field crops (alfalfa and other hay/seed crops, reduced by more than 20 percent). Other beneficial breeding

habitats such as rangeland and pasture have decreased by about 15 percent.

Mallards will readily nest in wheat and oats when planted near wetlands or rice (Loughman et al. 1991; Matchett et al. 2006). Furthermore, fields with annual crops can be fallowed as part of a crop rotation, or during periods of drought when irrigation water is not available or is designated for other uses (e.g., water transfers), whereas orchards remain in production every year. Fallow fields, especially when planted with a cover crop, are used by nesting hens of all three focal duck species (Yarris and Loughman 1990; Loughman et al. 1991, CWA 2013).

Landscape Changes and Breeding Duck Populations

Habitat changes on survey transects

A recent analysis of data comparing land use in 1998 versus 2016 along the CDFW breeding duck survey transects indicates that the amount of breeding habitat has declined by 17 percent in that time period (Figure 8.5; M. Cassazza, unpublished data, 2019, see “Notes”). This analysis shows that land uses that provide habitat for breeding ducks, which include wetlands, rice, pasture and other annual crops, have declined substantially, while incompatible land uses such as orchards, vineyards and urban development are increasing. Overall, potential breeding duck habitat within the transects in the CVJV area declined by about 70,280 acres (17 percent) due to conversion to incompatible land uses.

Conversion to orchards accounted for 64,450 fewer acres (16 percent) of duck habitat across transects. Relative to the respective total area of each type of habitat, conversion to orchards represents a six percent loss of rice, 13 percent loss of pasture and 22 percent loss of other annual crops. Relative to the respective area of each habitat, conversion to urban uses represented 0.24 percent loss of wetland, two percent loss of pasture and two percent loss of other annual crops. Wetland was the only habitat to increase during the 18-year period (14 percent more wetland in 2016 than 1998), the result of restoration of wetlands on former rice fields, pasture and other annual crops. Impacts on habitat area varied among regions, with greater loss occurring in the southern Central Valley, where greater than 25% habitat loss occurred on portions of survey transects (San Joaquin and Tulare planning regions; Figure 8.5).

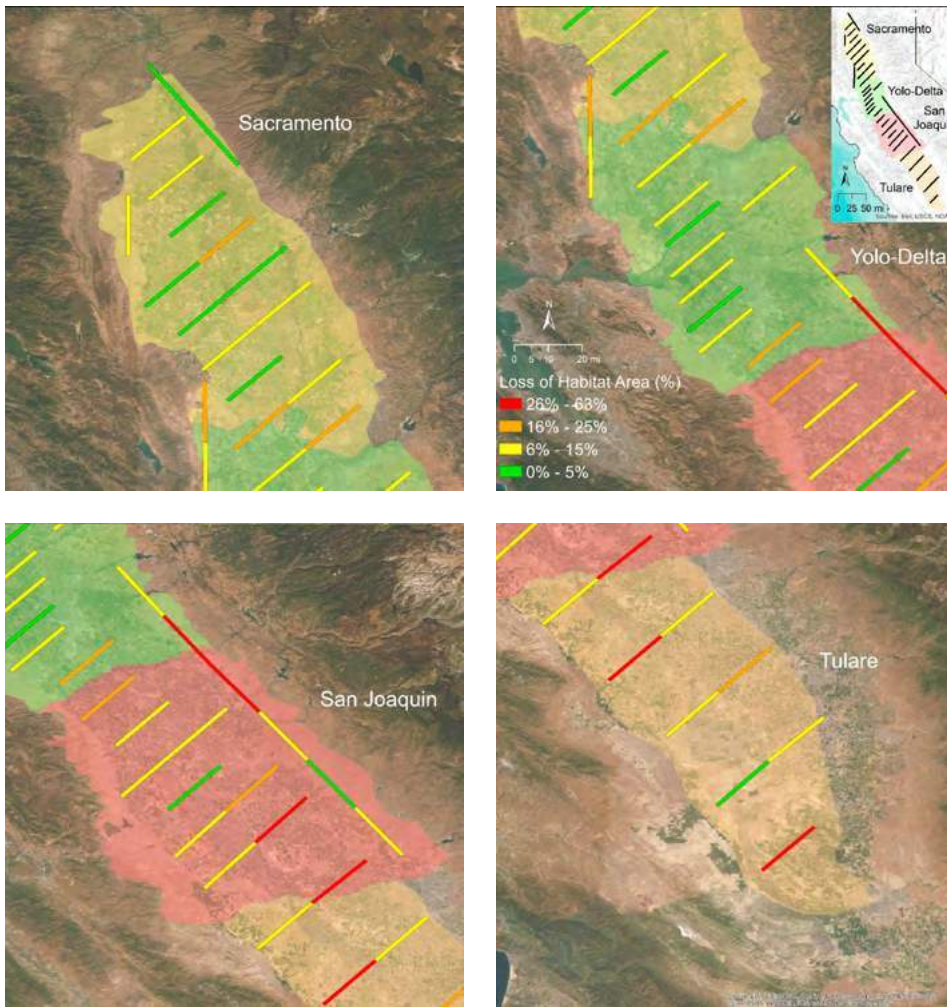

FIGURE 8.5 Change in available potential waterfowl breeding habitat from 1998 to 2016 in waterfowl breeding population transects surveyed in the Central Valley. Habitat includes managed wetlands, annual cropland and pasture. Non-habitat includes orchards and vineyards, forests and urban areas. Inset shows survey transects within four Central Valley planning regions (Sacramento, Yolo-Delta, San Joaquin and Tulare). Four panels, one for each region, indicate the percentage change in area of potential breeding habitat between the years 1998 and 2016.

Trends in agriculture

The relationship between the annual number of breeding mallards and the extent of various crops in each planning region (excluding Suisun, because of limited agriculture in that region) were recently examined using simple linear regression models to explore what might be affecting the long-term decline of mallards and to direct conservation priorities (D. Skalos, unpublished data, 2020, see “Notes”). These relationships are not causal, yet they do provide insight when considered together with other factors (e.g., weather and wetland availability) and expert opinion. The relationship between changes in dominant agriculture classes and decline of mallard breeding populations was similar in all planning regions, namely, there was a negative correlation between acres of tree crops and urban development and the number of breeding mallards. Conversely, there was often a positive correlation between crops that provide upland nesting habitat (e.g., row crops, field crops and pasture) and the number of breeding mallards.

Mallard population and land use change relationships appeared strongest in the Sacramento planning region (D. Skalos, unpublished data, 2020, see “Notes”). Mallards are more reliant on agricultural lands for breeding in this region, which could explain the trend. Mallards readily use flooded rice field habitat during the spring because the timing of planting and flooding of the fields coincides with the nesting season. Small grain crops, especially winter wheat, as well as hay and other irrigated annual crops compatible with nesting mallards, are often grown in association with rice, providing an attractive mix of upland and aquatic habitats (Earl 1950; Loughman et al. 1991; Matchett et al. 2006). However, small grain crops are also the crop types most likely to be converted to perennial crops (e.g., orchards) because of suitable soils, existing irrigation infrastructure and water rights and the relatively low profitability of wheat, hay and other annual crops. Thus, conversion of these annual crop types in proximity to flooded rice fields and natural wetlands is likely contributing to the decline of mallards in the Sacramento Valley.

Other contributing factors

Trends in potential nesting habitat in agricultural areas are well-documented, but changes in status or condition of other upland areas have not been examined. A considerable amount of natural upland area exists in association with private and public wetlands; changes to these habitats could influence use by or success of nesting ducks. For example, changes in plant species composition or vegetation structure related to various factors can influence use of potential nesting habitats. Invasive plants (e.g., Himalayan blackberry [*Rubus armeniacus*], star thistle [*Centaurea solstitialis*], pepperweed [*Lepidium* sp.] and the *Phragmites* reed [*Phragmites australis*]) can reduce habitat suitability for nesting hens. Increased woody vegetation, either through natural succession or by planting trees and hedgerows, is known to negatively influence use of habitat by grassland-nesting birds (Bakker 2003).

Additionally, changes to nesting densities (Ackerman et al. 2004), to predator populations (Croston et al. 2018) and to the populations of other prey species that duck predators also target (Ackerman 2002) can all have substantial effects on duck nest survival. Increases in certain predators (e.g., common ravens [*Corvus corax*], American crows [*Corvus brachyrhynchos*] and various raptors) have also been documented in areas of the Central Valley (Coates et al. 2017). Expansion of existing wetlands into adjacent uplands, although beneficial to non-breeding waterfowl and other waterbirds, can be detrimental to nesting ducks in areas where the lack of suitable upland habitat is limiting reproduction. Shifts in climate may also be contributing to recent declines in mallards and other nesting birds (Ackerman et al. 2011), as these declines coincide with record high temperatures and below-normal precipitation. Breeding duck populations were especially suppressed during the recent drought from 2011 to 2017 (Skalos and Weaver 2019). The influence of these climate-related changes is largely unknown and more subtle than widespread changes in agriculture or complete habitat loss from urbanization. However, they should not be ignored, especially in areas where ducks are less dependent on agriculture but still in decline.

Wetland Trends

Changes in wetland habitat available during spring and summer for breeding ducks and their broods are more difficult to track than changes in agricultural lands, and thus have not been documented (nor have trends in natural uplands for nesting habitat). The total extent of managed wetlands has increased since the formation of the CVJV in 1988 (see the Conservation Delivery chapter). However, most of these restored wetlands are managed seasonally for migrating and wintering birds and are typically dry during

the summer. A small fraction of these wetlands is managed as permanent or semi-permanent wetlands and thus are available during the breeding season. However, the wetland acreage available in any given season is highly variable and dependent on a number of factors, such as management goals and priorities, water availability and/or cost, and the annual maintenance budget.

The historical long-term loss of permanent and semi-permanent wetlands is well-documented and is proportionately greater than the loss of seasonal wetlands (Frayser et al. 1989; Heitmeyer et al. 1989; California State University Chico 2003). The amount of permanent and semi-permanent wetlands available annually since breeding waterfowl surveys were initiated in 1992 is not well understood, so any correlation to the decline of locally breeding ducks is uncertain. (Also note that these two types of wetlands are often grouped together) Importantly, the documented declines in California breeding duck populations occurred after most of these large-scale wetland losses, meaning that the loss of wetlands alone cannot explain the decline in breeding ducks over the past two decades.

The overall acreage of all types of wetlands available within the breeding duck survey transects has increased by 14 percent since 1998, based on a recent analysis of land cover changes (M. Cassazza, unpublished data, 2019, see “Notes”). However, the management goal and hydroperiod of these wetlands – for example, whether a particular wetland is flooded year-round or only during some part of the year – is unknown. Consistent with management of most wetlands in the Valley, more recently restored wetlands are likely dry during the spring and summer.

An analysis of satellite imagery from 2009 quantified the extent of wetlands in the CVJV planning area and determined the proportions managed as either seasonal or as permanent/semi-permanent (Petrik et al. 2014). The results of this study indicated a total of 201,200 acres of managed wetlands in the Valley. Approximately 10 percent (21,000 acres) were still flooded in June and were likely managed as permanent or semi-permanent wetlands (this study referred to both types of wetlands collectively as semi-permanent). There were geographic differences in the proportion of wetlands managed as semi-permanent, ranging from four percent in the San Joaquin planning region to about 16 percent in the Suisun and Yolo-Delta planning regions. The Sacramento planning region and Tulare planning region had about seven percent and 11 percent classified as semi-permanent wetlands (planning regions adapted from planning basins in Petrik et al. 2014).



Mallard nest - Mike Peters, USFWS

From 2009 to 2015, an additional 17,300 acres of wetlands were restored, bringing the total amount of managed wetlands to 218,500 acres (D. Fehring, unpublished data, 2016, see “Notes”). The CVJV assumed 10 percent (1,730 acres) of recently restored wetlands were managed as permanent/semi-permanent, consistent with the 2009 mapping results. The analysis of 2009 imagery also considered ownership (private or public) when delineating wetland habitat and showed that private wetlands had a slightly greater proportion managed as permanent/semi-permanent compared to public wetlands. Roughly two-thirds of the total wetland area in the Valley is under private ownership.

Because the last evaluation was conducted in 2009 and only considered a single year (Petrik 2014), it is unknown if the amount of spring- and summer-flooded wetlands from that study represents the current situation. The recent drought in California (2011-2017) gave rise to several water policy changes (e.g., the Sustainable Groundwater Management Act). These changes, combined with increasing competition for water, changing water prices and other factors, may have changed the distribution and amount of wetlands flooded during the spring and summer.

Rice fields are an important surrogate “wetland” in the Sacramento Valley, providing important habitat for breeding ducks

and their broods (Earl 1950; McLandress et al. 1996; Yarris 2008). The amount of rice planted annually during the last three years (average of 482,300 acres; 2017-2019) is similar to the 10-year period when mallards were most abundant (average of 480,300 acres; 1992-2001) and only slightly lower than the average planted annually since breeding duck surveys were initiated in 1992 (average of 508,600 acres; 1992-2019) (USDA 2019a).

Developing the Habitat Objectives

A key assumption in waterfowl habitat conservation is that habitat conservation programs can have a positive impact on the vital rates limiting the population during specific life cycle events (Reynolds et al. 2001). The habitat improvements most likely to increase breeding duck populations in the Central Valley include increasing the amount of wetlands available in spring and summer for breeding ducks, and increasing the amount of, and enhancing the quality of, upland habitat used for nesting.

Wetland habitat

Most wetlands in the Central Valley are managed. The hydroperiod and depth of flooding is artificially manipulated depending on the management goal and the availability of water. There are four basic wetland management strategies in the Central Valley: seasonal; reverse-cycle; semi-permanent; and permanent (these last two types are often grouped together).

Seasonal wetlands are generally flooded October through March (and are commonly drained and irrigated in spring and summer to promote wetland plant seed production). Reverse-cycle wetlands are flooded approximately March through July. Semi-permanent wetlands are generally flooded October through July. Permanent wetlands are flooded year-round. All provide benefits to locally nesting ducks, albeit at different stages of the breeding or post-breeding cycle. At a minimum, wetland habitats of some type should be flooded and available for breeding and post-breeding ducks in the spring and summer period from April 1 to August 1.

For many wetland managers, the primary goal of managing seasonal wetlands is to provide energetic resources (food) for waterfowl during the fall and winter. Water levels in seasonal wetlands are typically drawn down in spring to stimulate new growth of desired forage (moist-soil) plants (Heitmeyer et al. 1989). Seasonal wetlands provide important habitat for breeding duck pairs just prior to nesting, especially if water is not drawn off until April or May. However, this wetland type does not benefit duck broods, except temporarily for early-hatched broods or in situations where swales or perimeter

“borrow” ditches are left flooded through summer (Chouinard and Arnold 2007). Seasonal wetlands can provide “upland” nesting habitat if water is removed before the nesting season and new growth or residual wetland vegetation provides enough cover to conceal nests. (Note, however, that the effectiveness of this type of vegetation as nesting habitat has not been thoroughly evaluated; it is thought to be less used than more traditional upland habitat.)

Reverse-cycle wetlands are a less common type of seasonal wetlands. They are only flooded during the spring and summer (March to August) and are dry during the fall and winter. The dry period during the fall and winter allows annual grasses and other herbaceous plants to become established. When flooded during the spring, the decomposing vegetation provides optimal conditions for invertebrate production beneficial to breeding ducks and ducklings. Reverse-cycle wetlands have been documented to have approximately four times the duckling survival of semi-permanent wetlands (Chouinard and Arnold 2007). This increased survival rate over the more-continuous flood period of permanent and semi-permanent wetlands is likely because of improved invertebrate food resources resulting from their long drying period and lower vulnerability to predators (de Szalay et al. 2003; Chouinard and Arnold 2007).

Semi-permanent wetlands are flooded for most of the year, but water is removed for a short period (typically six to eight weeks) in late summer or early fall. When managed for breeding ducks, the water level is usually maintained continuously until late July or early August. The presence of summer water encourages tules, cattails and other emergent plants that provide cover for duck broods and molting adults. Wetland maintenance and nutrient cycling includes vegetation manipulation (disking, burning, etc.) during the dry period prior to flooding in the fall. In many cases, semi-permanent wetlands that reach an ecological steady state are left dry during the summer to control invasive plants that become established under the extended hydroperiod.

Permanent wetlands remain flooded throughout the year and, depending on the water depth and clarity, provide a mixture of emergent vegetation and open water with submergent aquatic vegetation (most or all of the plant structure is submerged). Permanent wetlands typically support a diverse but relatively small invertebrate population, due to low primary productivity associated with stable water levels and vegetation associated with a steady-state ecosystem. Permanent wetlands provide habitat for breeding adults and broods and are especially valuable to post-breeding molting adults in mid- to late summer (Kohl 2019). Redheads, ruddy ducks and mallards will

nest in robust emergent vegetation in both semi-permanent and permanent wetlands (Maxson and Riggs 1996).

Upland habitat

Characteristics of uplands attractive to nesting dabbling ducks include the presence of vegetation (residual or new growth) that is tall (greater than 12 inches) and dense enough to conceal incubating hens and their nests (Ackerman et al. 2009); locations reasonably close (less than half a mile) to wetlands or other water sources (e.g., rice fields, waterways); and the presence of relatively few trees or other potential roost sites for avian predators. When upland vegetation is not suitable to provide nesting cover but the other two conditions are met, planted cover crops or grasses can increase use by and success of nesting ducks (Loughman et al. 1991).

Mallards, gadwall and cinnamon teal use a diversity of upland and wetland habitats for nesting (Baldassare 2014). Mallards are especially adaptable and use a variety of agricultural and natural habitats for nesting. Mallards in the Central Valley nest in predictable cover types, such as annual and perennial grasses, but also in fields of herbaceous plants and shrubs, growing crops (especially oats and winter wheat), cover crops, fallow or idle farmland, and over water in emergent wetland vegetation (McLandress et al. 1996). Upland cover types used by nesting gadwall are similar to mallards, but in the Valley gadwall do not commonly nest in growing crops such as winter wheat or over water in wetland vegetation (although these habitats are used by nesting gadwall elsewhere; Maxson and Riggs 1996, Skone et al. 2016). Cinnamon teal also use a variety of cover types for nesting but generally prefer sites closer to water than mallards or gadwall, and they typically require shorter vegetation for nest concealment.

The amount of existing nesting habitat available to breeding ducks in the Valley is unknown. There is considerable spatial land cover data for the CVJV planning area, but it has not been analyzed recently, nor has it been analyzed relative to the ecological requirements of the three focal breeding species. Because of the importance of agriculture to nesting ducks (especially mallards), only an analysis using relatively current data would be meaningful, given the significant land use changes that have occurred since the last Implementation Plan in 2006. An inventory of nesting habitat suitable for mallards, gadwall and cinnamon teal in each of the planning regions remains a priority for the CVJV.

Using the abundant nesting information available for mallards, the CVJV determined the amount of nesting habitat needed to support the population at the level of the minimum objective (the LTA) and at the long-term objective (the 90th

percentile of the LTA). Because mallards are the most numerous focal duck species for the CVJV, providing enough nesting habitat to meet the needs of the mallard population when it has reached the long-term objective should also meet the needs of gadwall and cinnamon teal populations. The CVJV's long-term objective for breeding mallards is 305,500 individuals and the minimum objective is 201,400 (Table 8.2).

In order to estimate the amount of upland nesting habitat needed to maintain this breeding population, a series of assumptions were made using historical nesting data. Nesting uplands would need to be located within five miles of final brood wetlands and no more than 0.5 miles from the nearest wetland that the ducks can use as transit water from the upland nesting field to the final brood wetland. Assuming half of the breeding mallards are female, then nesting habitat for 152,750 mallard hens is needed to meet the needs of the long-term population objective. Using this target breeding population of hens and dividing this number by their expected nest density allows the CVJV to estimate the required amount of nesting habitat.

The expected density of nesting hens was estimated as the observed nest density of 1.42 nests per acre (arithmetic average of Grizzly Island Wildlife Area nest studies from 1985 to 2004 and 2008 to 2009; J. Ackerman, unpublished summary data, 2019b, see "Notes"). An estimated 57 percent of hens will re-nest after a failed nest attempt, that is, after losing a nest to egg predation or other factors (Arnold 2009). When adjusting the nest density to account for the estimated number of nests that are from re-nesting hens, the estimated nest density of 1.42 nests per acre is reduced to 0.86 nests per acre. (Nest density and success were estimated using the method of Mayfield; see Miller and Johnson 1978).

Dividing the 152,750 mallard hens needed to reach the Plan's objectives by the expected density of 0.86 nests per acre results in an estimated upland nesting habitat requirement of 176,900 acres, located near suitable brood rearing wetlands that are flooded in the spring and summer from April 1 to August 1. Similarly, for the minimum population objective of 201,400 mallards, or 100,700 hens, an estimated upland nesting habitat requirement of 116,600 acres would be needed.

This upland habitat requirement estimate should be used with caution. It is based simply on the amount of upland nesting habitat needed to provide hens with enough space to continue to nest at their long-term average nest density. The current assumptions are that the available nest densities and nest success used are typical for most nesting areas in the Valley, and that nest densities, nest survival and re-nesting

potential do not vary with the number of breeding hens. These assumptions are likely to be incorrect. Grizzly Island Wildlife Area nesting densities are generally higher than those in other areas of California (McLandress et al. 1996), so estimated acres of habitat suggested here likely underestimate what would be needed to adequately support the breeding populations at objectives. However, this estimate provides an approximation based on current data and information, and on the limited modeling resources available.

Upland nesting habitat needed to meet the population objective for mallards

Number of Acres=

$$\begin{aligned} &(\text{target number of breeding hens}) \times \\ & \{(\text{Nest Density per Acre} \times \text{Nest Success}) + \\ & (\text{Nest Density per Acre} \times [1 - \text{Nest Success}]) - \\ & \{(\text{Nest Density per Acre} \times [1 - \text{Nest Success}] \times 0.57)\} \end{aligned}$$

CONSERVATION DELIVERY: Defining the Habitat Objectives

Wetland Habitat

The specific long-term habitat objective is to increase the area of wetlands currently managed as semi-permanent in the Central Valley to 20 percent of the current wetland base (Table 8.3). Generally, managers designate five to 15 percent of the wetland habitat as summer water for resident wildlife. The most recent assessment (in 2009) indicated that about 10 percent of the total wetland area (of all types) is managed as semi-permanent (Petrik et al. 2014). Another analysis, of a smaller number of recent wetland restoration projects from 2009-2015, indicated less than five percent were managed as semi-permanent (C.M. Brady, unpublished data, 2019, see “Notes”). Increasing the acreage from 10 percent to 20 percent of the current wetland base (2015 data) would add an additional 21,000 acres of semi-permanent wetlands (Table 8.3). The CVJV recommends increasing semi-permanent wetlands to meet habitat objectives, primarily by restoring additional wetlands, but also by altering the management of seasonal wetlands if impacts to non-breeding waterfowl are minimal.

Increasing the amount of semi-permanent wetlands will boost the dabbling duck population in several ways. It will increase breeding propensity and effort by providing additional food resources and territories for breeding pairs (Newbold and Eadie 2004; Howerter et al. 2014). Furthermore, increasing wetland habitat available at the time of hatch and continuing until fledging will likely improve duckling survival (Oldenburger 2008). More wetlands in summer will also provide much-needed habitat for post-breeding ducks and will likely improve adult survival during wing molt (Fleskes et al. 2010; Kohl 2019).

The CVJV is only recommending a wetland habitat objective for semi-permanent wetlands at this time. These wetlands provide much-needed summer habitat and the water management and maintenance schedule is the most realistic option for most wetland managers. There is evidence that reverse-cycle wetlands provide superior foraging habitat for duck broods, as described previously, but few studies have been conducted (de Szalay et al. 2003). Moreover, reverse-cycle wetlands are dry during the fall and winter. This status further reduces habitat needed by migratory waterbirds and eliminates the option to hunt waterfowl, which is a primary purpose of many private and public managed wetlands. Semi-permanent wetlands provide suitable habitat for breeding ducks, while still maintaining value during the remainder of the year. Ideally, a portion of the semi-permanent wetlands included in this habitat objective would be substituted with reverse-cycle wetlands, especially in areas known to support high densities of breeding ducks, or in wetland units that would benefit from an extended dry period due to their steady-state vegetation.

The acreage of additional wetlands in each region needed to meet the 20 percent objective is variable (Table 8.3). Based on the most recent assessment (Petrik et al. 2014), the largest deficits to achieving the 20 percent criteria are in the Sacramento and San Joaquin planning regions. There is evidence that the extent of semi-permanent wetlands in certain planning regions is overestimated and need revising (e.g., Tulare does not have a surplus; C.M. Brady, unpublished data, 2019, see “Notes”). As such, semi-permanent wetland objectives for each planning region will be updated periodically as more recent data on current wetland status become available.

Upland Habitat

The total amount of suitable upland nesting habitat required to meet the CVJV long-term population objective is estimated to be almost 177,000 acres, as detailed in the previous section. The total amount of upland nesting habitat required to meet the minimum population objective is approximately 117,000 acres. This upland habitat would need to be located within 5 miles of final brood wetlands and no more than 0.5 miles from the nearest wetland that ducks can use as transit water to the final brood wetland. Because the current amount of suitable nesting habitat is unknown, it is not currently possible to determine how much additional acreage is needed to meet the population objectives. The CVJV considers determining the amount of existing suitable upland nesting habitat a high priority, in order to then establish objectives for additional acres of upland nesting habitat.

Most of the planning regions have areas with suitable nesting habitat. Increasing the extent of semi-permanent wetlands near those areas would likely improve duck breeding success. An exception is the Sacramento planning region, where rice agriculture provides summer aquatic habitat, but uplands are lacking. The decline in the mallard population in that planning region is greater than in other areas of the Central Valley, likely due to land use changes (Figure 8.2). The amount of rice grown there annually has remained relatively stable during the past 30 years; however, the complementary agriculture (annual crops such as winter wheat or pasture) and fallow rice fields that provide nesting habitat near growing rice fields has drastically declined.

To improve breeding success of ducks nesting near rice fields, the CVJV developed a habitat objective to provide suitable upland nesting cover equal to 10 percent of the recent rice crop base (based on the minimum acreage previously set aside by rice farmers as part of a price support program, before changes to the Farm Bill in 1996; that landscape supported a more robust breeding duck population than currently exists).

Actions that could meet this objective would include planting nesting cover or a suitable cover crop on fallow farm fields and leaving the cover undisturbed during the breeding season. The CVJV used the average amount of rice grown annually during 2007 to 2014 to determine the rice base and thus to set the conservation objective. During that period, an average of 541,000 acres of rice were grown annually. Therefore, the objective for planted nesting cover is 54,100 acres. Meeting this objective will likely require programs that offer economic incentives that are competitive with commodity markets and Farm Bill Programs.

SUMMARY

Conservation planning for waterfowl and wetland management in the Central Valley has largely focused on meeting the needs of wintering and migrating waterfowl. Meanwhile, locally nesting duck species have substantially declined and are now at or near all-time lows. Hundreds of thousands of ducks spend their entire life cycles in the Valley; their habitat needs differ from wintering ducks in the region. Providing semi-permanent wetland and upland habitat as outlined in this chapter, in addition to traditional wintering habitat, is paramount to sustaining local duck populations. A robust waterfowl population is important for keeping hunters engaged, who in turn advocate for and contribute financially toward sustaining private and public wetlands in the Central Valley. This chapter highlights the need to shift the management paradigm, which currently focuses on wintering and migrating waterfowl, to achieve a more balanced approach to meeting the full life cycle needs of locally nesting waterfowl.



Mallard brood - Mike Peters

The Habitat Objectives

To meet the long-term population objectives:

- Semi-permanent wetlands: 44,000 acres (21,000 additional acres)
- Upland nesting habitat: 177,000 acres, with 54,100 acres focused in the Sacramento region (research is needed to determine the amount of additional acreage this objective represents)

Based on a review of existing population and habitat information, the CVJV determined that providing additional semi-permanent wetlands and upland nesting habitat in all planning regions would be the best approach to reverse the decline of locally nesting focal duck species and work toward reaching the long-term population objective.

PLANNING REGION	CURRENT WETLANDS (2015 ESTIMATE)	SEMI-PERMANENT WETLANDS: CURRENT	SEMI-PERMANENT WETLANDS: OBJECTIVE ^a	SEMI-PERMANENT WETLAND DEFICIT
Sacramento	73,842	5,348	14,768	9,420
Yolo-Delta	25,965	4,010	5,193	1,183
Suisun	34,247	5,494	6,849	1,355
San Joaquin	61,247	2,872	12,250	9,378
Tulare	23,868	5,034	4,774	0 ^c
Total	219,169	22,758	43,834	21,336

^a Based on restoring an amount of semi-permanent wetlands equal to 20% of the current wetland extent.

^b Deficit is the difference between the current acreage and the objective for semi-permanent wetland acreage. Deficits represents additional wetland acreage needed.

^c A more recent analysis indicates semi-permanent wetlands were overestimated in Tulare for this Plan, so this result is being revised upward (C.M. Brady, unpublished data, 2019, see "Notes").

TABLE 8.3 Current wetlands of all types, current semi-permanent wetlands and the habitat objectives for semi-permanent wetlands, in the Valley as a whole and by planning region. (Sums may not be exact, due to rounding in original data.)

SUCCESS STORY

THE CALIFORNIA WATERFOWL HABITAT PROGRAM



Established via the California Waterfowl Habitat Preservation Act, the California Waterfowl Habitat Program (also known as the Presley Program) is a statewide, private-land incentive program administered by the California Department of Fish and Wildlife (CDFW). The program compensates private landowners who are willing to manage their land in accordance with management plans cooperatively developed by CDFW and the landowners. These management plans are designed to implement waterfowl habitat goals as identified by the CVJV's most recent Implementation Plan and CDFW's State Wildlife Action Plan. Consistent with its primary waterfowl habitat objectives, the program also endeavors to enhance habitat for shorebirds, wading birds and other wetland-dependent wildlife.

The Presley Program has been in existence for close to 30 years and has remained extremely popular with private landowners. In the most recent solicitation (2019), CDFW received interest from approximately 200 properties encompassing 50,000 acres. At current funding levels, implementation of the program over the next 10 years will result in a net gain of more than 3,000 acres of semi-permanent wetlands and the annual enhancement of approximately 20,000 acres of seasonal wetlands within the Central Valley. Secure, long-term funding has been the limiting factor in implementing the Presley Program across the Central Valley.





2



3

(1) Cinnamon teal brood - Mike Peters (2) Upland nesting habitat - Elliott Matchett (3) Mallard ducklings hatching - Brian Huber

LITERATURE CITED

- Ackerman JT. 2002. Of mice and mallards: positive indirect effects of coexisting prey on waterfowl nest success. *Oikos* 99:469-480.
- Ackerman JT, Blackmer AL, Eadie JM. 2004. Is predation on waterfowl nests density dependent? Tests at three spatial scales. *Oikos* 107:128-140.
- Ackerman JT, Herzog MP, Salas L, Gardali T, Ballard G, Loughman D, Yarris GS, Eadie JM. 2011. Avian breeding demographic response to climate change: a multi-species and multi-landscape approach to synthesizing risk factors. Summary Report, U.S. Geological Survey, Western Ecological Research Center, Davis, CA; PRBO Conservation Science, Petaluma, CA; California Waterfowl Association, Sacramento, CA; University of California, Davis, CA. 190 p. Available from: <http://climate.calcommons.org/bib/avian-demographic-response-climate-change-multi-species-and-multi-landscape-approach>.
- Ackerman JT, Herzog MP, Yarris GS, Casazza ML, Burns E, Eadie JM. 2014. Waterfowl Ecology and Management. Pages 103-132 in Moyle PB, Manfree A, Fiedler PL, eds. *Suisun Marsh: ecological history and possible futures*. University of California Press: Berkeley, CA. 239 p.
- Ackerman, JT, Kwolek J, Eddings R, Loughman D, Messerli J. 2009. Evaluating upland habitat management at the Grizzly Island Wildlife Area: effects on dabbling duck nest density and nest success. Administrative Report, U.S. Geological Survey, Western Ecological Research Center, Davis, CA and California Waterfowl Association, Sacramento, CA; 26 p.
- Ackerman JT, Takekawa JY, Orthmeyer DL, Fleskes JP, Yee JL, Kruse KL. 2006. Spatial use by wintering greater white-fronted geese relative to a decade of habitat change in California's Central Valley. *J Wildl Manag* 70:965-976.
- Assessment Steering Committee. 2007. North American Waterfowl Management Plan continental progress assessment. Final report. Canadian Wildlife Service, U.S. Fish and Wildlife Service, Secretaria de Medio Ambiente y Recursos Naturales. Available from: <https://nawmp.org/sites/default/files/2018-02/2007ContinentalAssessment.pdf>
- Bakker KK. 2003. The effect of woody vegetation on grassland nesting birds: an annotated bibliography. The Proceedings of the South Dakota Academy of Science 82:119-141. Updated January 2008.
- Baldassarre GA. 2014. Ducks, geese and swans of North America. Johns Hopkins University Press, Baltimore, Maryland. 1027 p. [2 volume set]. ISBN 978-1-4212-0751-7.
- Baldassarre GA, Bolen EG. 2006. Waterfowl ecology and management. Krieger Publishing Company, Malabar, Florida. 567 p.
- Beedy EC, Deuel BE. 2008. Redhead (*Aythya americana*). In Shuford WD, Gardali T, eds. *California bird species of special concern*. Studies of western birds 1:85-90. Available from: <https://nrm.dfg.ca.gov/FileHandler.ashx?DocumentID=10380&inline>
- California State University Chico. 2003. The Central Valley Historic Mapping Project. Chico Department of Geography and Planning and Geographic Information. Available from: https://www.waterboards.ca.gov/waterrights/water_issues/programs/bay_delta/docs/cmnt081712/sldmwa/csuhicodp-tofgeographyandplanningcentralvalley.pdf
- Cameron DR, Marty J, Holland RF. 2014. Whither the rangeland?: protection and conversion in California's rangeland ecosystems. *PLoS ONE* 9(8):e103468. doi: 10.1371/journal.pone.0103468
- Chouinard Jr MP, Arnold TW. 2007. Survival and habitat use of mallard (*Anas platyrhynchos*) broods in San Joaquin Valley, California. *Auk* 124:1305-1316.
- [CDOC] California Department of Conservation. 2019. California Farmland Conversion Reports 1992-2012. Sacramento, CA, USA. Available online: <https://www.conservation.ca.gov/dlrp/fmmp/Pages/Farmland%20Conversion%20Reports.aspx>
- Coates PS, Brussee BE, Howe KB, Fleskes JP, Dwight IA, Connelly DP, Meshriy MG, Gardner SC. 2017. Long-term and widespread changes in agricultural practices influence ring-necked pheasant abundance in California. *Ecology and Evolution* 27:2546-2559.
- Croston R, Ackerman JT, Herzog MP, Kohl JD, Hartman CA, Peterson SH, Overton CT, Feldheim CL, Casazza ML. 2018. Duck nest depredation, predator behavior, and female response using video. *J Wildl Manag* 82:1014-1025. Available from: <https://doi.org/10.1002/jwmg.21444>
- [CVJV] Central Valley Joint Venture. 2006. Central Valley Habitat Joint Venture implementation plan - conserving bird habitat. U.S. Fish and Wildlife Service. Sacramento, CA.
- [CWA] California Waterfowl Association. 2013. Rice-cover crop rotation pilot project. Waterfowl, giant garter snake, wetland monitoring, and economic evaluation. Final report to California Department of Fish and Game Ecosystem Restoration Program. Grant Agreement No. E0720022/ERP-05-S27, California Waterfowl Association, Roseville, CA.
- De Sobrino CN, Feldheim CL, Arnold TW. 2017. Distribution and derivation of dabbling duck harvests in the Pacific Flyway. *California Fish and Game* 103:118-137.
- de Szalay FA, Carroll LC, Beam JA, Resh VH. 2003. Temporal overlap of nesting duck and aquatic invertebrate abundances in the Grasslands Ecological Area, California, USA. *Wetlands* 23:739-749.
- Devries JH, Brook RW, Howerter DW, Anderson MG. 2008. Effects of spring body condition and age on reproduction in mallards (*Anas platyrhynchos*). *The Auk* 125:618-628. doi: 10.1525/auk.2008.07055
- Dugger BD, Coluccy JM, Dugger KM, Fox TT, Kraege D, Petrie MJ. 2016. Population dynamics of mallards breeding in eastern Washington. *J Wildl Manag* 80:500-509. Available from: <https://doi.org/10.1002/jwmg.1030>
- Earl JP. 1950. Production of mallards on irrigated land in the Sacramento Valley, California. *J Wildl Manag* 14:332-342.
- Feldheim CL, Ackerman JT, Oldenburger SL, Eadie JM, Fleskes JP, Yarris GS. 2018. California mallards: a review. *California Fish and Game* 104:49-66. Available from: <https://pdfs.semanticscholar.org/6ab1/5934dd82052f9448be9ff67a4a56b4171a09.pdf>
- Fleskes JP, Mauser DM, Yee JL, Blehert DS, Yarris GS. 2010. Flightless and post-molt survival and movements of female mallards molting in Klamath Basin. *Waterbirds* 33:208-220. Available from: <https://doi.org/10.1675/063.033.0209>
- Fleskes JP, Yee JL, Yarris GS, Loughman DL. 2016. Increased body mass of ducks wintering in California's Central Valley. *J Wildl Manag* 80:679-690.
- Fleskes JP, Yee JL, Yarris GS, Miller MR, Casazza ML. 2007. Pintail and mallard survival in California relative to habitat, abundance, and hunting. *J Wildl Manag* 71:2238-2248.
- Fraye WE, Peters DD, Pywell HR. 1989. Wetlands of the California Central Valley: status and trends: 1939 to mid-1980s. U.S. Fish and Wildlife Service; Portland, Oregon, USA. Available from: https://www.fwspubs.org/doi/suppl/10.3996/012014-JFWM-003/suppl_file/012014-jfwm-003.s10.pdf
- Heitmeyer ME, Connelly DP, Pederson RL. 1989. The Central, Imperial and Coachella Valleys of California. Pages 475-505 in Smith LM, Pederson RL, Kaminski RM, eds. *Habitat management for migrating and wintering waterfowl in North America*. Texas Tech University Press, Lubbock.
- Hoekman ST, Gabor TS, Maher R, Murkin HR, Lindberg MS. 2006. Demographics of breeding female mallards in southern Ontario, Canada. *J Wildl Manag* 70:111-120. Available from: [https://doi.org/10.2193/0022-541X\(2006\)70\[11:DOBFM\]2.0.CO;2](https://doi.org/10.2193/0022-541X(2006)70[11:DOBFM]2.0.CO;2)

- Hoekman S T., Mills LS, Howerter DW, Devries JH, Ball IJ. 2002. Sensitivity analyses of the life cycle of midcontinent mallards. *J Wildl Manag* 66:883-900. doi:10.2307/3803153
- Howerter DW, Anderson MG, Devries JH, Joynt BL, Armstrong LM, Emery RB, Arnold TW. 2014. Variation in mallard vital rates in Canadian Aspen parklands: the Prairie Habitat Joint Venture assessment. *Wildlife Monographs* 188:1-37. Available from: <https://doi.org/10.1002/wmon.1012>
- Johnson DH, Nichols JD, Schwartz MD. 1992. Population dynamics of breeding waterfowl. Pages 446-485 in Batt BDJ, Afton AD, Anderson MG, Ankney CD, Johnson DH, Kadlec JA, Krapu GL, eds. Ecology and management of breeding waterfowl. University of Minnesota Press, Minneapolis.
- Kohl JD. 2019. Identifying postbreeding molting sites and factors influencing molting chronology for gadwall (*Mareca strepera*) and mallards (*Anas platyrhynchos*) nesting in the Suisun Marsh of California. MS Thesis, University of California, Davis, CA, USA.
- Loughman, DL, Yarris GS, McLandress RM. 1991. An evaluation of waterfowl production in agricultural habitats of the Sacramento Valley. Final report to California Department of Fish and Game. California Waterfowl Association, Sacramento, CA, USA.
- Matchett EL, Loughman DL, Laughlin JA, Eddings RD. 2006. Factors that influence nesting ecology of waterfowl in the Sacramento Valley of California: an evaluation of the Conservation Reserve Enhancement Program. Final report submitted to the California Department of Fish and Game.
- Maxson S, Riggs M. 1996. Habitat use and nest success of overwater nesting ducks in west-central Minnesota. *J Wildl Manag* 60:108-119. doi: 10.2307/3802045
- McDuie F, Casazza ML, Overton CT, Herzog M, Hartman CA, Peterson SH, Feldheim CL, Ackerman JT. 2019. GPS tracking data reveals daily spatiotemporal movement patterns of waterfowl. *Movement Ecology* 7:6. Available from: <https://doi.org/10.1186/s40462-019-0146-8>
- McLandress MR, Yarris GS, Perkins AEH, Connelly DP, Raveling DG. 1996. Nesting biology of mallards in California. *J Wildl Manag* 60:94-107.
- Miller HW, Johnson DH. 1978. Interpreting the results of nesting studies. *J Wildl Manag* 43:471-476. doi: 10.2307/3800806
- Newbold S, Eadie JM. 2004. Using species-habitat models to target conservation: a case study with breeding mallards. *Ecological Applications* 14:1384-1393.
- [NAWMP] North American Waterfowl Management Plan. 2012. North American Waterfowl Management Plan 2012: people conserving waterfowl and wetlands. North American Waterfowl Management Plan. <https://www.dgif.virginia.gov/wp-content/uploads/north-american-waterfowl-management-plan-2012.pdf>
- [NAWMP] North American Waterfowl Management Plan. 2014. Revised objectives: an addendum to the 2012 North American Waterfowl Management Plan. Canadian Wildlife Service, United States Fish and Wildlife Service, Secretaria de Medio Ambiente y Recursos Naturales. Available from: <https://www.fws.gov/migratorybirds/pdf/management/NAWMP/2012NAWMPRevisedObjectives.pdf>
- Oldenburger SL. 2008. Breeding ecology of mallards in the Central Valley of California. MS Thesis, University of California, Davis, CA, USA.
- Olson SM, Compiler. 2019. Pacific Flyway data book, 2019. U.S. Department of Interior, Fish and Wildlife Service, Division of Migratory Bird Management, Vancouver, Washington. Available from: <https://www.fws.gov/migratorybirds/pdf/surveys-and-data/DataBooks/PacificFlywayDatabook.pdf>
- Pacific Flyway Council. 2000. Subcommittee on Pacific Population of Western Canada Geese. Pacific Flyway Management Plan for the Pacific population of western Canada geese. Pacific Flyway Study Committee. (c/o USFWS, MBMO) Portland, Oregon. Unpubl. Rept. Available from: http://www.pacific-flyway.gov/Documents/Pwgc_plan.pdf
- Pandolfino ER, Handel CM. 2018. Population trends of birds wintering in the Central Valley of California. Pages 215-235 in Shuford W.D., Gill R.E. Jr., Handel C.M., eds. Trends and traditions: avifaunal change in western North America. Studies of Western Birds 3. Western Field Ornithologists, Camarillo, CA. doi: 10.21199/SWB3.12
- Petrik K, Fehring D, Weverko A. 2014. Mapping seasonal managed and semi-permanent wetlands in the Central Valley of California. Final report to the Central Valley Joint Venture. Ducks Unlimited, Inc. Rancho Cordova, CA.
- Reynolds R, Shaffer T, Renner R, Newton W, Batt B. 2001. Impact of the Conservation Reserve Program on duck recruitment in the U.S. Prairie Pothole Region. *J Wildl Manag*. 65:765-780. doi: 10.2307/3803027
- Sauer JR, Niven DK, Hines JE, Ziolkowski Jr DJ, Pardieck KL, Fallon JE, Link WA. 2017. The North American Breeding Bird Survey, results and analysis 1966-2015. Version 2.07.2017 USGS Patuxent Wildlife Research Center, Laurel, MD.
- Sedinger JS, Alisauskas RT. 2014. Cross-seasonal effects and the dynamics of waterfowl populations. *Wildfowl* 4:277-304. Available from: <https://wildfowl.www.org.uk/index.php/wildfowl/article/view/2609>
- Skalos D, Weaver M. 2019. 2019 California Waterfowl Breeding Population Survey report, 25 p. Sacramento, CA, USA. Available from: <https://nrm.dfg.ca.gov/FileHandler.ashx?DocumentID=146708&inline>
- Skone BR, Rotella JJ, Walker J. 2016. Waterfowl production from winter wheat fields in North and South Dakota. *J Wildl Manag* 80:127-137. Available from: <https://doi.org/10.1002/jwmg.993>
- Sleeter BM, Wilson TS, Sharygin E, Sherba JT. 2017. Future scenarios of land change based on empirical data and demographic trends. *Earth's Future* 5:1068-83. Available from: <https://doi.org/10.1002/2017EF000560>
- Thomas DR. 2009. Assessment of waterfowl body condition to evaluate the effectiveness of the Central Valley Joint Venture. Thesis, University of California, Davis, CA, USA.
- Trost RE, Drut MS. Compilers. 2003. Pacific Flyway: mail questionnaire harvest survey results, 1965-2001. U.S. Fish and Wildlife Service, Division of Migratory Bird Management, Portland, Oregon.
- [USDA] U.S. Department of Agriculture. 2019a. National Agriculture Statistics Service. Quick stats database. Available from: <https://quickstats.nass.usda.gov/>
- [USDA] U.S. Department of Agriculture. 2019b. National Agriculture Statistics Service. Statistics by state: California Agricultural Commissioner's reports 1992-2017. Available from: https://www.nass.usda.gov/Statistics_by_State/California/Publications/AgComm/index.php
- [USFWS] U.S. Fish and Wildlife Service. 2008. Adaptive Harvest Management: 2008 hunting season. U.S. Dept. Interior, Washington, D.C. 54 p. Available from: <https://www.fws.gov/migratorybirds/pdf/management/AHM/AHMReport2008.pdf>
- [USFWS] U.S. Fish and Wildlife Service. 2019a. Waterfowl population status, 2019. U.S. Department of the Interior, Washington, D.C. USA. Available from: <http://www.fws.gov/birds/management/adaptive-harvest-management/publications-and-reports.php>
- [USFWS] U.S. Fish and Wildlife Service. 2019b. Adaptive Harvest Management: 2020 hunting season. U.S. Department of Interior, Washington, D.C. 72 p. Available from: <http://www.fws.gov/birds/management/adaptive-harvest-management/publications-and-reports.php>
- Yarris GS. 2008. Survival of mallard ducklings in the rice-growing region of the Sacramento Valley, California. MS Thesis, University of California, Davis, CA, USA.

Yarris GS, Loughman DL. 1990. An evaluation of waterfowl production on set-aside lands in the Sacramento Valley, California. Final report to the California Department of Fish and Game and the National Fish and Wildlife Foundation. California Waterfowl Association, Sacramento, CA, USA.

Yarris GS, McLandress MR, Perkins AEH. 1994. Molt migration of postbreeding female mallards from Suisun Marsh, California. *Condor* 96:36–45.

Yparraguirre DR, Hunt EG, Connelly DP, Weaver ML. 2014. Bringing science to waterfowl management in the California Department of Fish and Game. *California Fish and Game* 100:473–490. Available from: <https://nrm.dfg.ca.gov/FileHandler.ashx?DocumentID=93575&inline>

Zeulak DS, Barthman LM, McLandress MR. 1991. Revision of the waterfowl breeding population and habitat survey in California. California Waterfowl Association, Sacramento, CA, USA.

NOTES

Ackerman, JT. 2019a. USGS. Data regarding the recent increase in Gadwall nests in Suisun Marsh. Available from: jackerman@usgs.gov.

Ackerman, JT. 2019b. USGS. Grizzly Island Wildlife Area nest studies from 1985–2004 and 2008–2009. Available from: jackerman@usgs.gov.

Brady, CM. 2019. California Waterfowl Association. Data relative to extent of semi-permanent wetlands in the Central Valley, California, 2009–2015. Available from: cbrady@calwaterfowl.org.

Cassazza, M. 2019. USGS. Preliminary data about habitat trends relative to CDFW breeding duck population survey transects. Available from: mike_casazza@usgs.gov.

Fehringer D. 2016. Ducks Unlimited. Email communication to G. Yarris regarding estimated wetland acres restored between 2009 and 2015 in the Central Valley.

Skalos, D. 2019. CDFW. Population estimates for CVJV planning regions. Available from: dan.skalos@cdfw.ca.gov.

Skalos, D. 2020. CDFW. Simple linear regression models to explore what landscape variable are affecting the long-term decline of mallards. Available from: dan.skalos@cdfw.ca.gov and online: <https://nrm.dfg.ca.gov/FileHandler.ashx?DocumentID=151989&inline>.



1

NON-BREEDING SHOREBIRDS

9

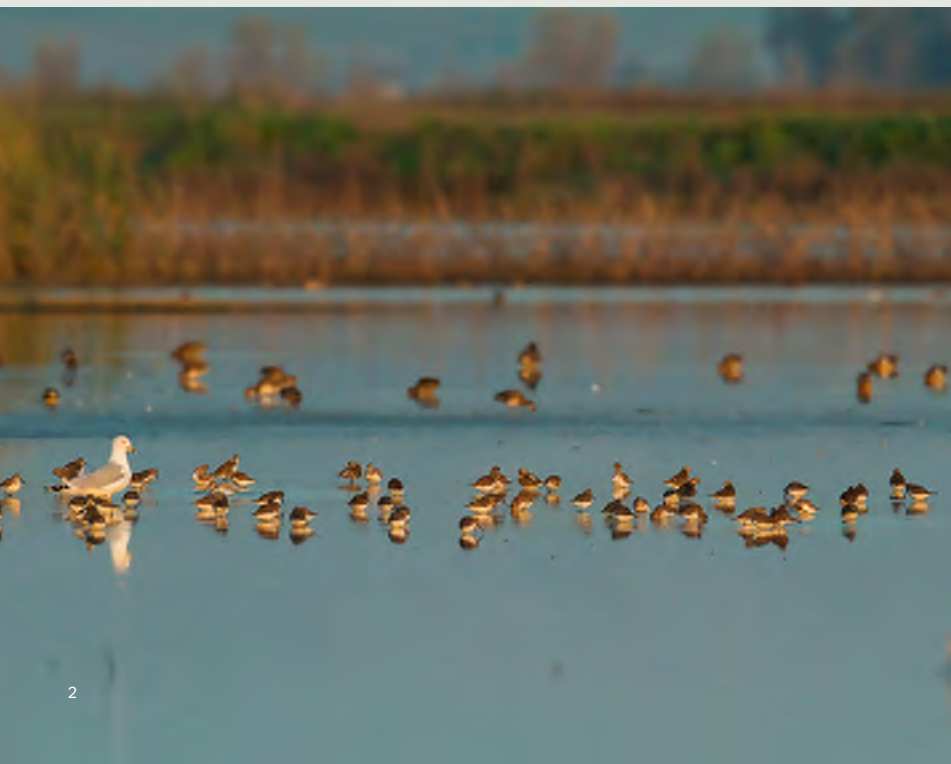

2



3

CHAPTER SUMMARY

The Central Valley supports large populations of numerous shorebird species during their 10-month non-breeding season (July – April), which includes winter as well as fall and spring migration. The Central Valley provides critical foraging habitat for these species and is a region of international significance for shorebird conservation. Protecting sufficient habitat to support resilient populations of these bird species also benefits other groups of birds, other wildlife, and the regional economy.

This chapter describes the conservation objectives for additional managed wetland acreage to be added during targeted fall and spring timespans. The goal is to prevent further loss and degradation of current habitat and provide additional habitat during critical time periods, to support resilient populations of Pacific Americas Flyway shorebird species. The Implementation Plan used a bioenergetics model to determine habitat needs over the course of each year.

The Conservation Delivery chapter in Section I integrates these habitat objectives with the habitat objectives for other bird groups in the Implementation Plan to present total habitat needs in the Central Valley. The chapter then describes conservation actions for achieving these integrated habitat objectives.

SHORT-TERM HABITAT OBJECTIVES: WHAT'S NEEDED?

5,400 ADDITIONAL ACRES IN FALL

11,600 ADDITIONAL ACRES IN SPRING

OF SHALLOW (<4 IN.) OPEN WATER IN MANAGED WETLANDS

BIRD SPECIES INCLUDE:

Representative shorebirds in the Central Valley in the non-breeding season:

Species of heightened conservation concern:



Greater yellowlegs*



Western sandpiper*



Long-billed dowitcher**



Whimbrel*



Wilson's snipe*



Long-billed curlew*



Dunlin*

HABITAT TYPE

Most of the shorebird species found in the Central Valley forage in shallow seasonal or semi-permanent wetlands, with water depths of less than four inches. Postharvest-flooded crop lands, especially rice and corn, also provide substantial foraging habitat for these bird species.

FORAGING HABITAT FOR NON-BREEDING SHOREBIRDS

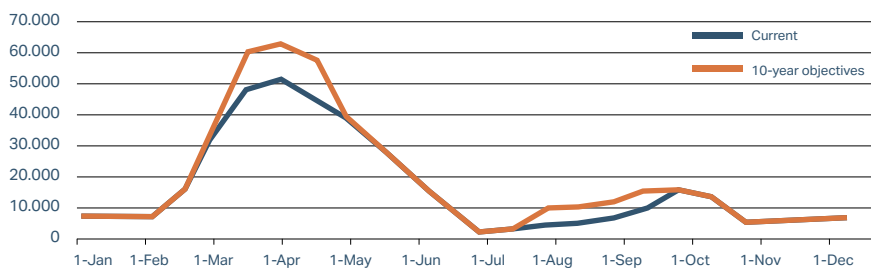

HABITAT SUCCESS STORIES

since the 2006 Implementation Plan

- Efforts to work with private landowners in the Grasslands Ecological Area to enhance wetland management can provide as much as 25% of the additional habitat needed annually to reach short-term habitat objectives during the spring (S. Arthur, personal communication, 2018, see "Notes").
- Rice fields strategically flooded during the fall season through the BirdReturns program attracted some of the highest densities of foraging shorebirds ever recorded for agriculture in the Central Valley (Golet et al. 2018).
- The Waterbird Habitat Enhancement Program (WHEP) reached more than 200 agricultural producers to enhance over 120,000 acres (20%) of rice fields in the Sacramento Valley for shorebirds (MBCP 2014).

* Image: Tom Grey ** Image: Brian Gilmore

(1) Juvenile western sandpipers during migration - Tom Grey
(2) Dunlin flock - Jim Dunn (3) Long-billed curlew - Tom Grey

INTRODUCTION

The Central Valley of California is one of the most important regions for migrating and wintering shorebirds in western North America, supporting up to 500,000 shorebirds each year (Shuford et al. 1998). A significant number of shorebird species use the Central Valley during most of the year (about July 1 to May 15) when they are not in the breeding phase of their life cycle. The quality and quantity of habitat available for these shorebirds during the non-breeding season can have important impacts on body condition, survival, and subsequent migration timing and reproductive success (e.g., Burton et al. 2006). Therefore, habitat conservation and management in the Central Valley can have an important influence on shorebird population dynamics and shorebird conservation well beyond this region.

The Central Valley is recognized as a region of international significance to shorebirds in the Pacific Americas Shorebird Conservation Strategy (Senner et al. 2016) and by the Western Hemisphere Shorebird Reserve Network (WHSRN 2009). The rice fields and wetlands in the Sacramento Valley and wetlands in the Grasslands Ecological Area of the San Joaquin Valley provide important habitat for these birds. However, the Central Valley has lost over 90 percent of its former wetlands to agriculture, channelization and urban development (Frayer et al. 1989). Central Valley shorebird populations were likely much larger prior to this habitat loss and now may be limited by the availability or quality of foraging habitat (Page and Gill 1994; Shuford et al. 1998).

Although it is no longer possible to restore wetlands to their pre-1900 extent, an extensive network of restored and managed wetlands and postharvest-flooded fields of rice, corn, and other row and field crops currently provide substantial habitat for non-breeding shorebirds in the Central Valley (Fleskes et al. 2012; Strum et al. 2013; Reiter et al. 2015). The total extent of foraging habitat required to support a robust shorebird community may be far less than historical levels, depending on how the extent, timing, and depth of flooding in these wetlands and agricultural lands are managed. Shorebirds have been the focus of multiple recent conservation programs in the Valley targeting private lands. These efforts are a mix of public (the Natural Resources Conservation Service's Waterbird Habitat Enhancement Program) and private programs (e.g., The Nature Conservancy's BirdReturns Program). The management practices supported by these programs are primarily annual. While there have been recent conservation gains through these programs, shorebird habitat remains vulnerable to changes in the availability of funding and the willingness and ability of landowners to participate every year.

Protecting and expanding Central Valley flooded habitats (including managed wetlands and seasonally-flooded agricultural fields) will benefit shorebirds and other wetland-dependent species. Deliberately flooded habitats can also benefit the people of the Central Valley in many ways, including reducing flooding that puts people and property at risk, improving air and water quality, recharging groundwater, and sequestering carbon (Finlayson et al. 1999; Zedler and Kercher 2005). They can also increase property values and attract wildlife watchers, hunters and other visitors, all of whom help support local economies (Carver 2013; Carver and Caudill 2013; Liu et al. 2013).

CONSERVATION GOAL

The Central Valley Joint Venture's long-term goals are to restore and enhance more shorebird habitat in the Central Valley and to reverse historical declines of shorebird populations in this region. This can be accomplished for non-breeding shorebirds by providing additional habitat during critical time periods during the non-breeding season, July 1 through May 15, thereby contributing to increasing, and more resilient, shorebird populations in the Pacific Americas Flyway.



Gray Lodge Wildlife Area - Brian Gilmore

WHICH SPECIES ARE INCLUDED?



Wilson's snipe - Tom Grey

The conservation objectives encompass all shorebird species that depend on shallow open water (less than 4 inches deep) for foraging habitat and were regularly observed during baseline surveys of Central Valley wetlands and flooded agriculture conducted during the non-breeding season between 1992 and 1995 (Shuford et al. 1998; Table 9.1). This Implementation Plan (hereafter, “the Plan”) assumes availability of shallow open water foraging habitat is the primary factor limiting the size of non-breeding shorebird populations in the Central Valley.

SPECIES (SCIENTIFIC NAME)	CONSERVATION STATUS ^a	CENTRAL VALLEY IMPORTANCE ^b
Black-necked stilt (<i>Himantopus mexicanus</i>)		
American avocet (<i>Recurvirostra americana</i>)	MCCV	●
Black-bellied plover (<i>Pluvialis squatarola</i>)	MCCV	
Snowy plover (<i>Charadrius nivosus</i>)	FT	
Semipalmated plover (<i>Charadrius semipalmatus</i>)		
Killdeer (<i>Charadrius vociferous</i>)	CSD	●
Whimbrel (<i>Numenius phaeopus</i>)	IM	●
Long-billed curlew (<i>Numenius americanus</i>)	MA	●
Marbled godwit (<i>Limosa fedoa</i>)	MA	
Dunlin (<i>Calidris alpina</i>)	MA	●
Least sandpiper (<i>Calidris minutilla</i>)		
Western sandpiper (<i>Calidris mauri</i>)	MCCV	●
Long-billed dowitcher (<i>Limnodromus scolopaceus</i>)		●
Wilson's snipe (<i>Gallinago delicata</i>)		●
Lesser yellowlegs (<i>Tringa flavipes</i>)	MA	
Willet (<i>Tringa semipalmata</i>)	MA	
Greater yellowlegs (<i>Tringa melanoleuca</i>)		●
Wilson's phalarope (<i>Phalaropus tricolor</i>)		
Red-necked phalarope (<i>Phalaropus lobatus</i>)	CSD	

^a Conservation status designations from the U.S. Shorebird Conservation Plan Partnership (USSCPP 2015): **FT**, listed as Threatened under the federal Endangered Species Act; **IM**, requires immediate management action; **MA**, needs management attention; **MCCV**, moderate climate change vulnerability but not **IM** or **MA**; and **CSD**, common shorebird in decline. Because non-breeding shorebirds in the Central Valley may include individuals from many different breeding sub-populations, shown here are only the highest shorebird conservation designation of any breeding sub-population listed in USSCPP 2015.

^b Southern Pacific Shorebird Conservation Plan (Hickey et al. 2003)

TABLE 9.1 Non-breeding shorebird species: Conservation status and Central Valley importance. Shorebird species listed are those regularly occurring in managed wetlands and flooded agricultural fields of the Central Valley during the non-breeding season. These are the species incorporated into the bioenergetics model and conservation objectives. Also shown are each species' current continental conservation status and whether the Central Valley is considered to be of primary importance to the U.S. population of the species.

WHICH GEOGRAPHIC AREAS ARE INCLUDED?

The conservation objectives apply to the CVJV's entire Primary Focus Area, except the Suisun Basin (Figure 9.1). The Suisun Basin was excluded because estimating shorebird foraging habitat availability in its tidally-influenced brackish wetlands was beyond the scope of the CVJV's current modeling efforts.

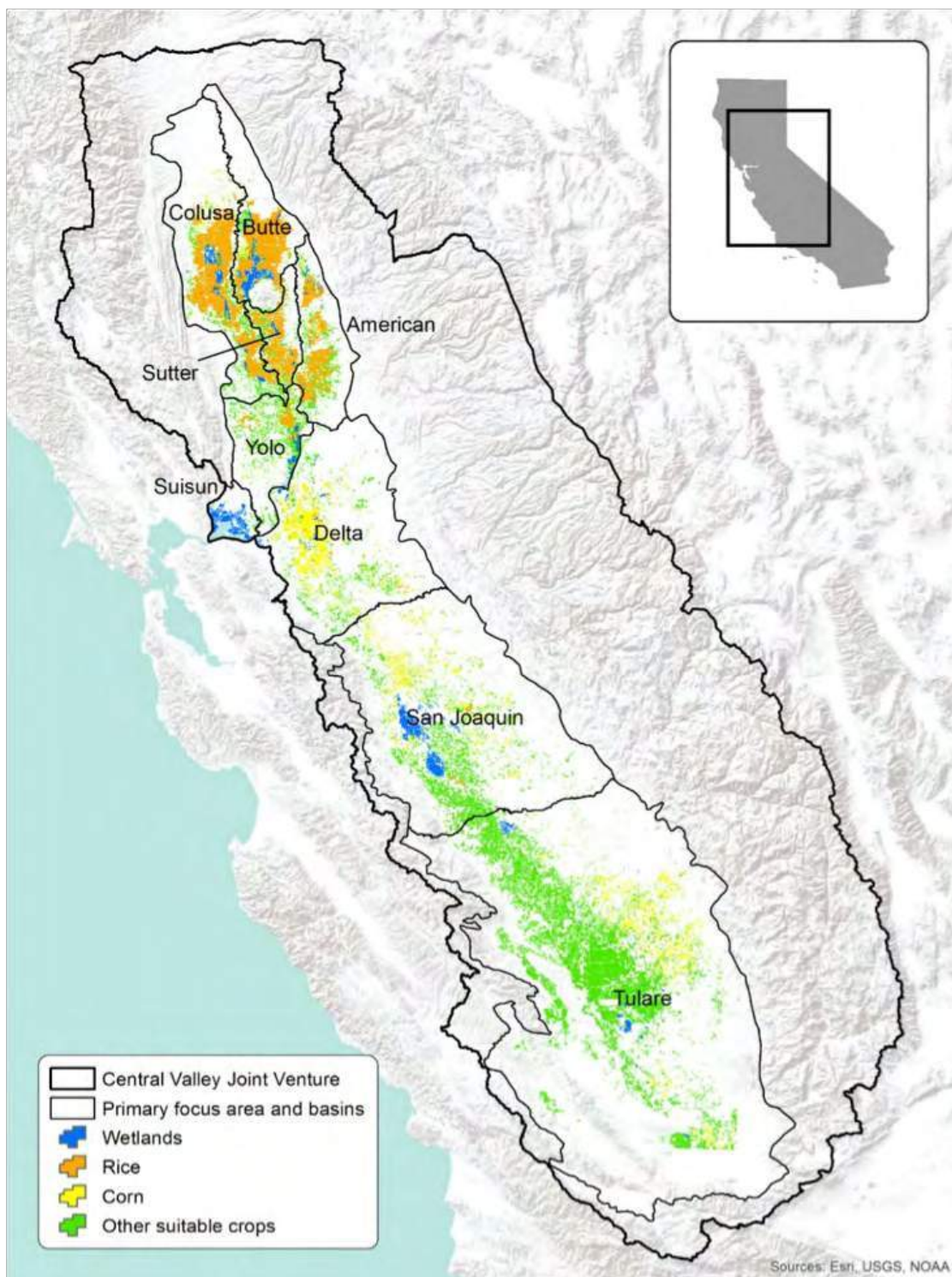

FIGURE 9.1 Central Valley Joint Venture perimeter, Primary Focus Area, and basins. Also shown is the distribution of potential foraging habitat for non-breeding shorebirds by land cover type. Wetlands data are from 2009; crop data are from 2007–2014.

CURRENT CONDITIONS

Current Population Sizes and Trends

Because over 90 percent of historical wetlands in the Central Valley have been lost (Frayer et al. 1989), the size of the non-breeding shorebird community using the Central Valley has likely declined by at least 50 percent from pre-1900 levels to the present. Current population size estimates are based on surveys of the Central Valley in the early to mid-1990s (Shuford et al. 1998), which showed an increase in shorebird abundance over the non-breeding season to peak in the spring (Figure 9.2). Although there have been no comparable comprehensive surveys since, a new program was established in 2011 to assess shorebird population trends in the westernmost United States and the Pacific Americas Flyway (Point Blue Conservation Science's Pacific Flyway Shorebird Survey, <http://www.pointblue.org/pfss>, which contributes data to the collaborative Migratory Shorebird Project, <http://www.migratoryshorebirdproject.org/>).

The CVJV reviewed continental and regional shorebird conservation assessments (Hickey et al. 2003; USSCP 2015) to characterize the current conservation status of shorebird species that regularly occur in the Central Valley during the non-breeding season. Of the 19 species assessed, 12 species are ranked with some level of conservation concern, and these assessments consider the Central Valley to be of primary importance to the U.S. population of nine of these species (Table 9.1).

Current Habitat

The availability of foraging habitat for shorebirds in the Central Valley changes between years and over the course of the non-breeding season. This variation depends on the total acres of managed wetlands and suitable agricultural fields each year, the proportion of these acres that are flooded on any given day, and the proportion of the flooded acres that are shallow enough (less than 4 inches) to be accessible to most shorebirds. Researchers estimated the total acres of potential shorebird habitat in each of the Central Valley basins (excluding Suisun) in managed wetlands and in rice, corn, and other field and row crops that may be flooded during irrigation or postharvest (Table 9.2).

For seasonal and semi-permanent managed wetlands, researchers used a GIS layer produced from 2009 satellite imagery (Petrik et al. 2014), supplemented by the estimated area of wetlands restored between 2009 and 2015 (D. Fehringer, personal communication, 2016, see "Notes") to estimate a recent (2015) total of 184,900 acres in the CVJV's Primary Focus Area. For crops, statewide survey statistics (NASS 2016) were combined with a GIS layer (The Nature Conservancy, unpublished data, 2015, see "Notes")

to estimate the 2007–2014 average extent of planted rice (541,400 acres), corn (261,000 acres, excluding corn grown in the San Joaquin and Tulare basins, which is rarely flooded postharvest), and other field and row crops (2,051,700 acres) in the CVJV's Primary Focus Area.

The proportion of each of these land cover classes that has open water on each day of the non-breeding season was estimated using satellite imagery of surface water collected over a similar time period (2007–2011; Reiter et al. 2015). The proportion of the area with open water that is shallow enough to be used by most foraging shorebirds (less than 4 inches) was then estimated in managed wetlands using expert opinion (C. Isola, personal communication, 2015, see "Notes") and in postharvest-flooded crops using data recently collected in rice fields (Strum et al. 2013; Sesser et al. 2016; Sesser et al. 2018). The final estimates of current total shorebird foraging habitat available in managed wetlands is summarized in two-week intervals in Table 9.3 and Figure 9.3. Current estimates of available foraging habitat in flooded agricultural lands is summarized in two-week intervals in Figure 9.4. See Dybala et al. (2017) for more detailed figures.

During the 2007–2015 time period, researchers estimated that total open water habitat in the Central Valley reached an average peak of 620,400 acres in early January. The proportion of this habitat that is accessible to shorebirds reached a much smaller average peak of 279,300 acres in mid-February, over a month later. Habitat accessible to shorebirds was lowest in the early fall, when shorebirds must rely primarily on managed wetlands, contributing to an estimated energy shortfall in most years from early August through late September.

In addition, the shorebird foraging habitat currently provided by managed wetlands does not yet meet the CVJV's goal of being capable of supporting 50 percent of current shorebird daily energy needs between October and March and 100 percent from July through September and April through May (CVJV 2006). Achieving this goal would limit reliance on postharvest-flooded crops, the availability of which may change rapidly with economic and climatic conditions or environmental policies (Johnston and Carter 2000; Hagy et al. 2014; Hatfield et al. 2014). Nevertheless, increases in the availability of shorebird foraging habitat in postharvest-flooded crops during any part of the non-breeding season could contribute to eliminating energy shortfalls.

DEVELOPING THE CONSERVATION OBJECTIVES

Population Objectives

The international importance of the Central Valley to shorebirds, the loss of over 90 percent of historical wetlands in the Central Valley (Frayer et al. 1989), and the likely declines in shorebird abundance of at least 50 percent from historical levels warrant setting relatively large population objectives. Therefore, the long-term (100-year) population objectives were set to double the baseline Central Valley population sizes, as determined in the 1992–1995 surveys (Shuford et al. 1998), thus reducing historical population declines. The population objectives vary over the course of the non-breeding season to reflect bird movements and represent the total number of shorebirds that the Central Valley will be able to support during each day of the non-breeding season (Figure 9.2).

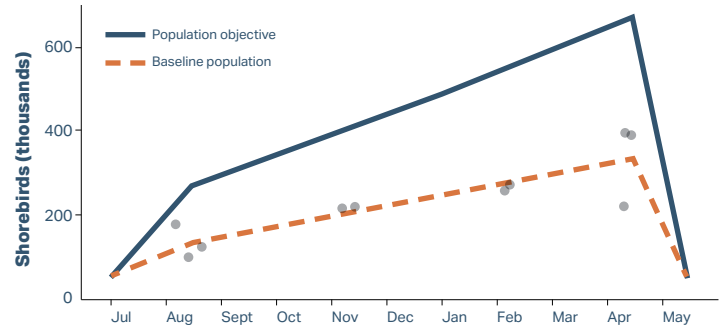

FIGURE 9.2 Non-breeding shorebird abundance: Current population and long-term objectives. Estimates are shown for the baseline population surveyed 1992–1995 (dashed line) and for the long-term (100-year) shorebird population objectives (2x baseline; solid line). Points show the estimates from the individual baseline surveys (Shuford et al. 1998).

Habitat Objectives

A bioenergetics modeling approach was used to estimate the amount of habitat required to support the population objectives over the course of the non-breeding season. Availability of foraging habitat is assumed to be the primary factor limiting shorebird abundance. Bioenergetics modeling is a tool to assess changes in energy supply and demand. Researchers estimated the daily shorebird energy demand from the number of birds in the community and estimates of their metabolic rate and energy assimilation efficiency. Then, the researchers estimated the daily energy supply from estimates of daily foraging habitat availability (described above in Current Conditions) and the average food energy provided per acre of foraging habitat.

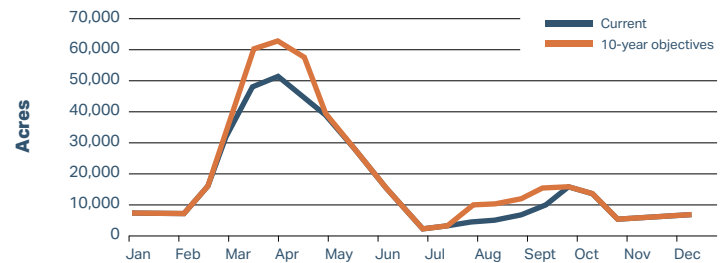

FIGURE 9.3 Current estimates and short-term (10-year) habitat objectives for shorebird foraging habitat in managed wetlands during the non-breeding season. Short-term objectives are equal to the current estimated acreage plus the additional acres needed by 2030.

For each day of the non-breeding season, the CVJV’s bioenergetics model compared daily energy demand to daily energy supply, keeping track of any shortfalls in energy and allowing any surpluses to carry forward to the next day. Where energy shortfalls were identified, researchers reran the model to find the minimum amount of additional shorebird foraging habitat in managed wetlands that would be required to eliminate the energy shortfalls.

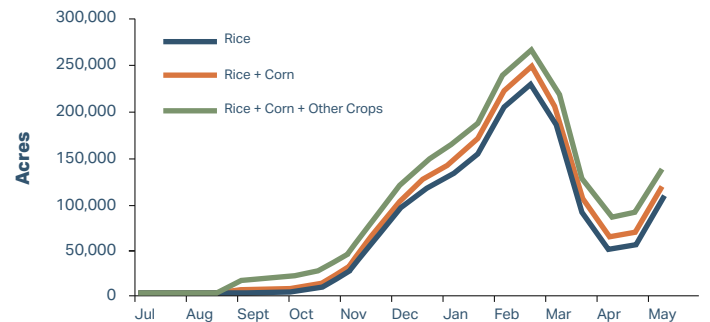

FIGURE 9.4 Current estimates of shorebird foraging habitat in flooded agricultural lands. Estimates include the average area of open water less than 4 inches deep between 2007 and 2014. The long-term habitat objectives are to maintain these current averages.

Additional details on the sources of data, methods, results, and references can be found in Dybala et al. (2017).

CONSERVATION OBJECTIVES

Habitat Objectives

The Plan defines short-term (10-year) and long-term (100-year) habitat objectives for shorebird foraging habitat (open water less than 4 inches deep) in the Central Valley’s managed wetlands (Table 9.3). The objectives represent the estimated total extent of shorebird foraging habitat in managed wetlands required to support the long-term population objectives, assuming no change in habitat availability in postharvest-flooded crops. The habitat objectives for managed wetlands vary throughout the non-breeding season, reflecting changes in both the size of the non-breeding shorebird community and the availability of habitat in managed wetlands and postharvest-flooded crops.

Subtracting the estimated current extent of foraging habitat in managed wetlands from the acreage of the long-term or short-term habitat objectives provides the estimated additional acres of foraging habitat in wetlands needed to reach the habitat objectives. These estimates assume no loss of existing foraging habitat. The additional acres are needed to eliminate periods of projected energy shortfalls during the early fall and the spring, when foraging habitat is currently limited.

For postharvest-flooded crops, including rice, corn, and other field and row crops, the CVJV assumed no change in the average total area planted (Table 9.2) and no change in the average timing and depth of flooding. Thus, the long-term objective for postharvest-flooded crops is to at least maintain the current average shorebird foraging habitat the crops provide throughout the non-breeding season. Strategically increasing the availability of this type of shorebird foraging habitat, particularly during the shortfall periods, can be a valuable part of the strategy for meeting the habitat objectives (see below).



Western sandpipers - Jim Dunn

BASIN	WETLANDS	RICE	CORN	OTHER ^a
Butte	37,102	135,537	7,429	27,712
Colusa	26,618	213,778	18,624	115,916
American	6,516	90,052	2,408	38,303
Sutter	3,607	70,506	4,889	29,418
Yolo	12,943	21,739	13,699	155,555
Delta	13,022	5,214	213,927	183,123
San Joaquin	61,247	4,536	-- ^b	461,450
Tulare	23,868	0	-- ^b	1,040,218
Total	184,922	541,362	260,976	2,051,697

^a Includes barley, beans, cotton, oats, safflower, sugar beets, sunflower, wheat, and total vegetables. Despite the large acreage of this crop class, only a very small fraction is ever flooded.

^b Excludes the substantial amounts of corn grown in the San Joaquin and Tulare basins, which is rarely flooded postharvest.

TABLE 9.2 Estimated extent of potential foraging habitat for non-breeding shorebirds, by basin and land cover type. Potential foraging habitat includes suitable land cover types that could provide foraging habitat if flooded. Basins are shown in Figure 9.1; Suisun basin not included. Estimates are given in acres and include the estimated extent of wetlands in 2015 and the average extent of 3 crop classes, 2007–2014. (Sums may not be exact, due to rounding in original data.)

HABITAT TYPE TIMING	LONG-TERM HABITAT OBJECTIVE	CURRENT ESTIMATE	ACRES NEEDED (DIFFERENCE)	ACRES NEEDED BY 2030 (10%)
Foraging Habitat In Managed Wetlands (open water less than 4 inches deep in seasonal or semi-permanent wetlands)				
1-15 Jul	2,277	2,277	0	0
16-31 Jul	3,229	3,229	0	0
1-15 Aug	58,111	4,741	53,370	5,337
16-31 Aug	58,636	5,266	53,370	5,337
1-15 Sep	60,269	6,899	53,370	5,337
16-30 Sep	63,663	10,293	53,370	5,337
1-15 Oct	16,239	16,239	0	0
16-31 Oct	13,702	13,702	0	0
1-15 Nov	5,284	5,284	0	0
16-30 Nov	5,686	5,686	0	0
1-15 Dec	6,335	6,335	0	0
16-31 Dec	6,937	6,937	0	0
1-15 Jan	7,393	7,393	0	0
16-31 Jan	7,542	7,542	0	0
1-15 Feb	7,307	7,307	0	0
16-29 Feb	16,397	16,397	0	0
1-15 Mar	34,950	34,950	0	0
16-31 Mar	165,172	49,230	115,942	11,594
1-15 Apr	168,426	52,484	115,942	11,594
16-30 Apr	162,472	46,530	115,942	11,594
1-15 May	39,614	39,614	0	0

NOTES: Objectives are to maintain the existing extent of foraging habitat in wetlands throughout the non-breeding season, and to add habitat during spring and fall. Objectives are for the entire Central Valley Primary Focus Area (excluding Suisun Basin).

TABLE 9.3 Short-term (10-year) and long-term (100-year) habitat objectives for shorebird foraging habitat in managed wetlands during the non-breeding season. Objectives are summarized for each two-week interval throughout the non-breeding season. Objectives are given in acres, along with current estimates of available foraging habitat in managed wetlands, the estimated additional acres needed to meet the long-term habitat objectives, and the short-term objective of meeting 10% of those acres by 2030.

Population Objectives

The long-term population objectives are to double baseline shorebird abundances throughout the non-breeding season. These objectives represent the estimated abundances needed to achieve the goal of reducing the impacts of historical wetland habitat losses, thereby contributing to more stable and resilient shorebird populations in the Pacific Americas Flyway. The target shorebird populations increase linearly through the year from the assumed starting point of 50,000 birds on 1 July (CVJV 2006) to 269,100 by 15 August, reach a peak of 666,700 by 15 April, and then decline sharply back to 50,000 by 15 May (Figure 9.2).

APPLYING THE CONSERVATION OBJECTIVES

Applying the Habitat Objectives

The habitat objectives were defined based on the simplest habitat management scenario to model: flooding additional wetland acres during the entire shortfall periods. Any new wetlands created and flooded starting in 2016 will contribute to the additional wetland acres needed, since the bioenergetics modeling was based on the estimated wetland extent in 2015. However, only the area of shallow open water available during the entirety of one of the shortfall periods would count as contributing to the habitat objectives. Similarly, changes in the management of existing wetlands could contribute to the habitat objectives, if they are managed to maintain a larger area of shallow open water during the entirety of one of the shortfall periods than was typically provided during 2007–2014 (the years over which average open water availability was estimated).

Progress toward achieving these habitat objectives can be measured by continuing to track wetland restoration efforts throughout the Central Valley and measuring surface water availability through satellite imagery (e.g., www.pointblue.org/watertracker). Regularly sampling the area of managed wetlands with open water less than 4 inches deep would provide more direct estimates of how shorebird foraging habitat is changing and would help ground-truth the other, more indirect estimates.

In addition to this simplest case, alternate approaches could be used to contribute to the shorebird population objectives. For example, it may be possible to achieve the same outcome by sequentially flooding a smaller number of wetland acres for shorter intervals during the shortfall periods. Similarly, it may be possible to meet the habitat objectives during the shortfall periods by strategically increasing the availability of shorebird foraging habitat in postharvest-flooded crops during the shortfall periods (see BirdReturns sidebar). However, since the energy density available to shorebirds in postharvest-flooded crops is estimated to be lower than that found in managed wetlands, more total acres of foraging habitat in postharvest-flooded crops would be required under this approach. Estimating the contributions of specific dynamic management plans to meeting shorebird energy demands would require additional evaluation using the bioenergetics model (Dybala et al. 2017).

The Plan does not define shorebird habitat objectives for mid-winter because an energy shortfall is not anticipated during this timeframe for the foreseeable future. However, the extent of habitat available mid-winter should not be considered surplus. In the bioenergetics model, winter foraging habitat is crucial in determining how long energy resources will



Whimbrel - Tom Grey

last into the spring. For example, any loss of flooded rice fields mid-winter would put more foraging pressure on food resources in managed wetlands. In turn, this loss could leave less food remaining in managed wetlands in the spring when all the rice and other croplands have been drawn down, and an even larger spring energy shortfall. On the other hand, an increase in flooded agricultural fields mid-winter, or delayed drawdown, could reduce foraging pressure on managed wetlands and preserve more of the food available in managed wetlands to support shorebirds later into the spring.

Any change in the extent of any of the land cover types considered, the proportion flooded, or the proportion of suitable depth for use by foraging shorebirds at any time of the year, would have non-linear, cascading effects on the energy shortfalls and habitat needs later in the non-breeding season, as estimated by the bioenergetics model. The impacts of changes in wetland management or postharvest-flooding practices during any part of the non-breeding season could be evaluated using the bioenergetics model (Dybala et al. 2017).

ADDITIONAL CONSERVATION CONSIDERATIONS



Colusa National Wildlife Refuge - Khara Strum

Manage for robust regional distribution of habitat

The Plan sets population objectives of doubling the baseline shorebird population throughout the Central Valley, but the relative abundance of individual species and available habitat varies by planning basin (Shuford et al. 1998). Thus, the Plan recommends that wetland restoration and management efforts are distributed across the Central Valley such that habitat is available for shorebirds throughout the region for the entire non-breeding season. This approach will increase the likelihood that all shorebird species in the Central Valley will benefit from conservation efforts, as will people and communities throughout the region. Further, distributing habitat across the Central Valley limits reliance on a single area; allows wildlife to select habitat from a broader range of environmental conditions (e.g., climate conditions, predator abundance, or disturbance from human activity); and builds in redundancy that would increase the resilience of shorebird populations and wetland ecosystem services in the face of environmental disasters in one area (Redford et al. 2011; Biggs et al. 2012).

Match managed water levels to specific needs

For planning purposes, the objectives simplify what is considered available foraging habitat (open water less than 4 inches deep). Some practical considerations for providing this habitat in managed wetlands are provided in Hickey et al. (2003), including: 1) coinciding drawdown of wetlands to match periods of peak shorebird abundance, 2) fluctuating water levels in wetlands throughout the winter and spring to mimic historic hydrology (Isola 1998), and 3) designing wetlands with varied topography within and among management units so that water depths suitable for use by most shorebirds are provided even as water levels in the wetlands vary throughout the non-breeding season.

SUCCESS STORY

BIRDRETURNS HABITAT PROGRAM

Non-breeding shorebirds require adequate foraging habitat across a long season (July to May), in a dynamic landscape subject to ever-changing precipitation and crop planting patterns. Recognizing the need for a flexible, short-term habitat incentive program to effectively meet conservation objectives, The Nature Conservancy launched BirdReturns in 2014. This program financially compensates landowners who provide short-term foraging habitat in the fall and spring “shoulder” seasons, which are critical to shorebirds that migrate through or overwinter in the Central Valley.

The amount, location, and timing of BirdReturns habitat changes every season in response to changes in Valley-wide habitat availability and landowners’ ability to cost-effectively create good habitat conditions. BirdReturns effectively rents off-season agricultural land to serve as shorebird habitat where and when it is needed.

Since the program launched, 50,000 acres have been conserved during one or more shoulder seasons. And the program is effective. For example, by providing habitat in rice fields during migration, the program documented some of the highest average shorebird densities ever recorded for agriculture in the region (Golet et al. 2018). BirdReturns lands provide a small, more flexible complement to other short-term conservation programs and more permanent habitat on wildlife refuges and private lands.





(1) Ideal shorebird foraging habitat, provided by BirdReturns program - The Nature Conservancy, Greg Golet (2) Rice straw being managed by rolling to mix with water and soil - California Waterfowl Association (3) Long-billed dowitchers and dunlin, foraging in postharvest-flooded agricultural field - Ryan DiGaudio (4) Long-billed dowitchers - Brian Gilmore

LITERATURE CITED

- Biggs R, Schlüter M, Biggs D, Bohensky EL, BurnSilver S, Cundill G, Dakos V, Daw TM, Evans LS, Kotschy K, et al. 2012. Toward principles for enhancing the resilience of ecosystem services. *Annu Rev Environ Resour.* 37:421–448. doi: 10.1146/annurev-environ-051211-123836
- Burton NHK, Rehfish MM, Clark NA, Dodd SG. 2006. Impacts of sudden winter habitat loss on the body condition and survival of redshank *Tringa totanus*. *J Appl Ecol.* 43:464–473. doi: 10.1111/j.1365-2664.2006.01156.x
- Carver E. 2013. Birding in the United States: a demographic and economic analysis. Arlington, Virginia: U.S. Fish and Wildlife Service, Division of Economics. Available from: <http://digitalmedia.fws.gov/cdm/singleitem/collection/document/id/1874/rec/3>
- Carver E, Caudill J. 2013. Banking on nature: The economic benefits to local communities of National Wildlife Refuge visitation. Washington, D.C.: U.S. Fish and Wildlife Service, Division of Economics. Available from: <http://digitalmedia.fws.gov/cdm/singleitem/collection/document/id/1832/rec/1>
- [CVJV] Central Valley Joint Venture. 2006. Central Valley Joint Venture Implementation Plan: Conserving bird habitat. Sacramento, CA: U.S. Fish and Wildlife Service. Available from: <http://centralvalleyjointventure.org>
- Dybala KE, Reiter ME, Hickey CM, Shuford WD, Strum KM, Yarris GS. 2017. A bioenergetics approach to setting conservation objectives for non-breeding shorebirds in California's Central Valley. *San Franc Estuary Watershed Sci.* 15(1):2.
- Finlayson CM, Davidson NC, Spiers AG, Stevenson NJ. 1999. Global wetland inventory – current status and future priorities. *Mar Freshw Res.* 50:717–727. doi: 10.1071/MF99078
- Fleskes JP, Skalos DA, Farinha MA. 2012. Bird use of fields treated postharvest with two types of flooding in Tulare Basin, California. *J Fish Wildl Manag.* 3:164–174. doi: 10.3996/092011-JFWM-056
- Golet GH, Low C, Avery S, Andrews K, McColl CJ, Laney R, Reynolds MD. 2018. Using ricelands to provide temporary shorebird habitat during migration. *Ecol Appl.* 28(2):409–426. doi: 10.1002/eap.1658
- Fraye WE, Peters DD, Pywell HR. 1989. Wetlands of the California Central Valley: status and trends: 1939 to mid-1980's. Portland, OR: U.S. Fish and Wildlife Service. Available from: http://www.fwspubs.org/doi/suppl/10.3996/012014-JFWM-003/suppl_file/012014-jfwm-003.s10.pdf
- Hagy HM, Yaich SC, Simpson JW, Carrera E, Haukos DA, Johnson WC, Loesch CR, Rei FA, Stephens SE, Tiner RW, Werner BA, Yarris GS. 2014. Wetland issues affecting waterfowl conservation in North America. *Wildfowl Special Issue* 4:343–367. Available from: <http://wildfowl.wwt.org.uk/index.php/wildfowl/article/view/2612>
- Hatfield J, Takle G, Grotjahn R, Holden P, Izaurralde RC, Mader T, Marshall E, Liverman D. 2014. Chapter 6: Agriculture. In: Melillo JM, Richmond TC, Yohe GW, editors. *Climate Change Impacts in the United States: The Third National Climate Assessment*. U.S. Global Change Research Program. p. 150–174. Available from: http://nca2014.globalchange.gov/system/files_force/downloads/low_NCA3_Full_Report_06_Agriculture_LowRes.pdf
- Hickey CM, Page GW, Shuford WD, Warnock S. 2003. Southern Pacific Shorebird Conservation Plan: A strategy for supporting California's Central Valley and coastal shorebird populations. Stinson Beach, California: PRBO Conservation Science. Available from: http://www.prbo.org/cms/docs/wetlands/SPSCPlan_010904.pdf
- Isola CR. 1998. Habitat use by foraging waterbirds in the Grasslands of California's northern San Joaquin Valley. M.S. Thesis, Humboldt State University, Arcata, CA.
- Johnston WE, Carter HO. 2000. Structural adjustment, resources, global economy to challenge California agriculture. *Calif Agric.* 54:16–22. doi: 10.3733/ca.v054n04p16
- Liu X, Taylor LO, Hamilton TL, Grigelis PE. 2013. Amenity values of proximity to National Wildlife Refuges: An analysis of urban residential property values. *Ecol Econ.* 94:37–43. doi: 10.1016/j.ecolecon.2013.06.011
- [MBCP] Migratory Bird Conservation Partnership. 2014. Waterbird Habitat Enhancement Program: Bird-friendly Farming in California Rice Fields. Report to the California Rice Commission. Available from: http://calrice.org/pdf/waterbird-habitatbro_web.pdf
- [NASS] National Agricultural Statistics Service. 2016. Quick Stats 2.0. [cited 2016 Feb 2]. U.S. Department of Agriculture. Available from: <https://quickstats.nass.usda.gov/>
- Page GW, Gill RE. 1994. Shorebirds in western North America: Late 1800s to late 1900s. *Stud. Avian Biol.* 15:147–160. Available from: https://sora.unm.edu/sites/default/files/journals/sab/sab_015.pdf
- Petrik K, Fehringer D, Weverko A. 2014. Mapping seasonal managed and semi-permanent wetlands in the Central Valley of California. Ducks Unlimited, Inc. Rancho Cordova, CA
- Redford KH, Amato G, Baillie JEM, Beldomenico P, Bennett EL, Clum N, Cook R, Fonseca G, Hedges S, Launay F, et al. 2011. What does it mean to successfully conserve a (vertebrate) species? *Bioscience* 61:39–48. Doi: 10.1525/bio.2011.61.1.9
- Reiter ME, Wolder MA, Isola JE, Jongsomjit D, Hickey CM, Carpenter M, Silveira JG. 2015. Local and landscape habitat associations of shorebirds in wetlands of the Sacramento Valley of California. *J Fish Wildl Manag.* 6:29–43. doi: 10.3996/012014-JFWM-003
- Senner SE, Andres BA, Gates HR, editors. 2016. Pacific Americas shorebird conservation strategy. National Audubon Society, New York, New York, USA
- Sesser KA, Reiter ME, Skalos DA, Strum KM, Hickey CM. 2016. Waterbird response to management practices in rice fields intended to reduce greenhouse gas emissions. *Biol Conserv.* 197:69–79. doi: 10.1016/j.biocon.2016.02.021
- Sesser KA, Iglecia M, Reiter ME, Strum KM, Hickey CM, Kelsey R, et al. 2018. Waterbird response to variable-timing of drawdown in rice fields after winter-flooding. *PLoS ONE* 13(10): e0204800. <https://doi.org/10.1371/journal.pone.0204800>
- Shuford WD, Page GW, Kjølmyr JE. 1998. Patterns and dynamics of shorebird use of California's Central Valley. *Condor* 100:227–244. doi: 10.2307/1370264
- Strum KM, Reiter ME, Hartman CA, Iglecia MN, Kelsey TR, Hickey CM. 2013. Winter management of California's rice fields to maximize waterbird habitat and minimize water use. *Agric Ecosyst Environ.* 179:116–124. doi: 10.1016/j.agee.2013.08.003
- [USSCPP] US Shorebird Conservation Plan Partnership. 2015. US Shorebirds of Conservation Concern – 2015. U.S. Fish and Wildlife Service, Division of Migratory Bird Management, Falls Church, Virginia. Available from <https://www.shorebirdplan.org/wp-content/uploads/2015/01/ShorebirdsConservationConcernJan2015.pdf>. 2016 update available from: <http://www.shorebirdplan.org/science/assessment-conservation-status-shorebirds>
- [WHSRN] Western Hemisphere Shorebird Reserve Network. 2009. Sites in the Western Hemisphere Shorebird Reserve Network. Available from: <https://www.whsrn.org/sites-1>
- Zedler JB, Kercher S. 2005. Wetland resources: Status, trends, ecosystem services, and restorability. *Annu. Rev Environ Resour.* 30:39–74. doi: 10.1146/annurev.energy.30.050504.144248

NOTES

Arthur S. 2018. Audubon California, email communication to K. Dybala regarding wetland enhancement in the Grasslands Ecological Area.

Fehringer D. 2016. Ducks Unlimited, email communication to K. Dybala regarding estimates of wetland acres restored between 2009 and 2015 in the Central Valley.

Isola C. 2015. U.S. Fish and Wildlife Service, email communication to K. Dybala regarding estimates of the proportion of flooded seasonal and semi-permanent/permanent wetlands that are less than 10 cm deep.

The Nature Conservancy. 2015. Suitable agriculture GIS layer, developed from the remotely-sensed CropScape Cropland Data Layer provided by the U.S.D.A. National Agricultural Statistics Service and processed to include only pixels that were consistently classified into one of several major crop classes in the majority of the years 2007–2014. Available from: Rodd.Kelsey@tnc.org



1

BREEDING SHOREBIRDS

10



2



3

CHAPTER SUMMARY

The three species of shorebirds considered in this chapter breed broadly in the Central Valley: the American avocet, black-necked stilt, and killdeer. The relative size of the Valley's breeding population of the killdeer is unknown, but those of the avocet and stilt account for one-fourth and one-sixth, respectively, of the estimated totals for these species in the continental United States. The American avocet and killdeer are considered to be of conservation concern nationally.

This chapter describes the process for developing conservation objectives for permanent and semi-permanent wetlands needed to support genetically robust, self-sustaining, ecologically functional, and resilient populations of breeding shorebirds in the Central Valley. Habitat objectives are based on population and density objectives developed for the three focal species of shorebirds and account for use of habitats other than wetlands.

The Conservation Delivery chapter in Section I integrates these habitat objectives with the habitat objectives for other bird groups in the Implementation Plan to present total habitat needs in the Central Valley. The chapter then describes conservation actions for achieving these integrated habitat objectives.

SHORT-TERM HABITAT OBJECTIVE:

ADD 28,500 ACRES OF PERMANENT AND SEMI-PERMANENT WETLANDS

TOTAL BREEDING SHOREBIRD HABITAT IN 10 YEARS:

45,800 ACRES

HABITAT TYPE

Primary habitats used by the three focal species of shorebirds breeding in the Central Valley include permanent and semi-permanent wetlands and shallowly flooded rice fields, with water depths from zero (mudflats) to 8 inches. These focal shorebirds nest on small earthen mounds in flooded habitat or on sparsely vegetated ground, including islands, adjacent to or surrounded by suitable foraging habitat. These conditions are required throughout the breeding season, which peaks from mid-April through mid-July.

SHORT-TERM HABITAT OBJECTIVE

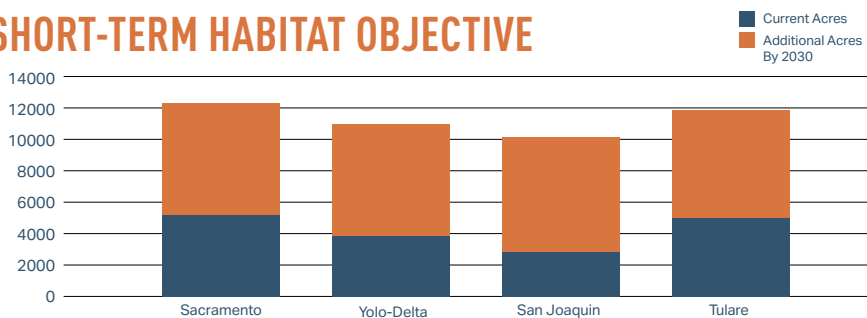

HABITAT SUCCESS STORIES

since the 2006 Implementation Plan

- Approximately 500 acres of permanent and semi-permanent wetland habitat was restored from 2009 to 2015.
- Nearly 54% of shorebirds breeding on private lands in the Tulare Basin were supported by private lands conservation programs such as the Agricultural Conservation Easement Program offered by the Natural Resources Conservation Service.
- Compensatory mitigation wetlands, designed to attract breeding shorebirds away from contaminated areas and to promote nesting success, have been highly successful in the Tulare Basin (Davis et al. 2008). This model could be considered as a complement to wetland restoration.

BIRD SPECIES INCLUDE:

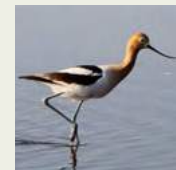

American avocet*



Black-necked stilt***



Killdeer**

* Image: Audubon California ** Image: California Rice Commission
*** Image: Brian Gilmore

(1) Male and juvenile black-necked stilts - Tom Grey (2) Breeding shorebird habitat - Khara Strum (3) Adult American avocet with chick - Mike Peters

INTRODUCTION

Historically, the Central Valley flooded seasonally, creating an estimated 2.4 million acres of wetlands. This landscape was one of the largest areas of naturally-occurring freshwater habitat west of the Great Lakes (Garone 2011). Today, the Central Valley has lost over 90 percent of its former wetlands to agriculture, channelization and urban development (Frayer et al. 1989). Flooded habitat is now largely provided by irrigated agriculture and by managed wetlands that are controlled or influenced by natural resource managers in some way. Given the changes to the extent, spatial distribution, and types of available habitat, populations of migratory birds that now rely upon wetland and agricultural habitats are likely much smaller than they were historically (Banks and Springer 1994; Page and Gill 1994).

In addition to supporting large populations of wintering and migrating shorebirds, the Central Valley provides breeding habitat for seven species of shorebirds (Hickey et al. 2003). The most numerous and widespread are the American avocet, black-necked stilt, and killdeer. The region supports nearly 24 percent and 17 percent of the national populations of breeding avocets and stilts, respectively (Shuford et al. 2007; USSCPP 2015). The relative population size of killdeer is unknown.

Breeding shorebirds in the Central Valley face a variety of threats. The most recent compilation of population trends and status for shorebirds in the United States lists the American avocet as vulnerable to shifting climate conditions and the killdeer as a common species in decline (Table 10.1; USSCPP 2015). These trends emphasize the need to protect and restore flooded habitat in the Central Valley during the shorebird breeding season, which peaks from mid-April through mid-July.

The primary habitats used by breeding shorebirds in the Central Valley include permanent and semi-permanent wetlands (hereafter referred to as semi-permanent wetlands) and flooded rice fields (Shuford et al. 2007). Conserving, enhancing and restoring these habitats will also provide value for other wildlife, including various other species of water-dependent birds. Benefits will also extend to the giant garter snake (*Thamnophis gigas*), a federally and state threatened species that requires flooded habitat, especially from March through October (Halstead et al. 2010). Providing additional wildlife habitat also benefits local communities economically, through increased property values, increased visitation by people enjoying wildlife viewing and other recreational opportunities (Liu et al. 2013; USFWS 2014).

The CVJV established conservation objectives for semi-permanent wetlands, and for population sizes and densities of the three focal species of shorebirds that breed in the Central Valley. This chapter explains these conservation objectives and how they can be applied to reach the conservation goals. The CVJV's approach provides a transparent, repeatable process for defining science-based conservation objectives for breeding shorebirds and their habitats in the Central Valley, which can help unite stakeholders around common goals and motivate conservation actions.

CONSERVATION GOAL

The Central Valley Joint Venture's long-term goal is for the Central Valley to have sufficient high-quality breeding habitat, particularly in semi-permanent wetlands, to support genetically robust, self-sustaining, ecologically functional, and resilient populations of breeding shorebirds.



(1) Killdeer tail distraction display - Robert A. Hamilton (2) Killdeer - Dan Skalos

WHICH SPECIES ARE INCLUDED?

Of the seven species of shorebirds breeding in the region, the CVJV evaluated three: the American avocet (avocet), black-necked stilt (stilt), and killdeer. These focal species (Table 10.1) were chosen because they are sufficiently common and widespread in the Central Valley to be useful for evaluating the effects of management and enhancement of habitat for their benefit.

Four additional species of shorebirds breed regularly in the Central Valley: the snowy plover, spotted sandpiper, Wilson's snipe, and Wilson's phalarope (CVJV 2006). These species are beyond the scope of this analysis because they either have small, localized breeding populations or nest in specialized habitats other than the semi-permanent wetlands and other habitats addressed here.

SPECIES (SCIENTIFIC NAME)	CONSERVATION STATUS ^a	CENTRAL VALLEY IMPORTANCE ^b
Black-necked stilt (<i>Himantopus mexicanus</i>)	LC	Moderate
American avocet (<i>Recurvirostra americana</i>)	MCCV	--
Killdeer (<i>Charadrius vociferous</i>)	CSD	Primary

^a Conservation status designations: CSD, common shorebird in decline; MCCV, moderate climate change vulnerability; LC, least concern (Shorebirds of Conservation Concern in the United States, USSCPP 2015)

^b Southern Pacific Shorebird Conservation Plan (Hickey et al. 2003)

TABLE 10.1 Focal species of breeding shorebirds: National conservation status and importance of the Central Valley for nesting.



Killdeer - Brian Gilmore

WHICH GEOGRAPHIC AREAS ARE INCLUDED?

Conservation objectives were defined for breeding shorebirds in four of the five planning regions, excluding Suisun, in the Central Valley's Primary Focus Area (Figure 10.1). Suisun was excluded because there are no population estimates of stilts and avocets for this planning region.

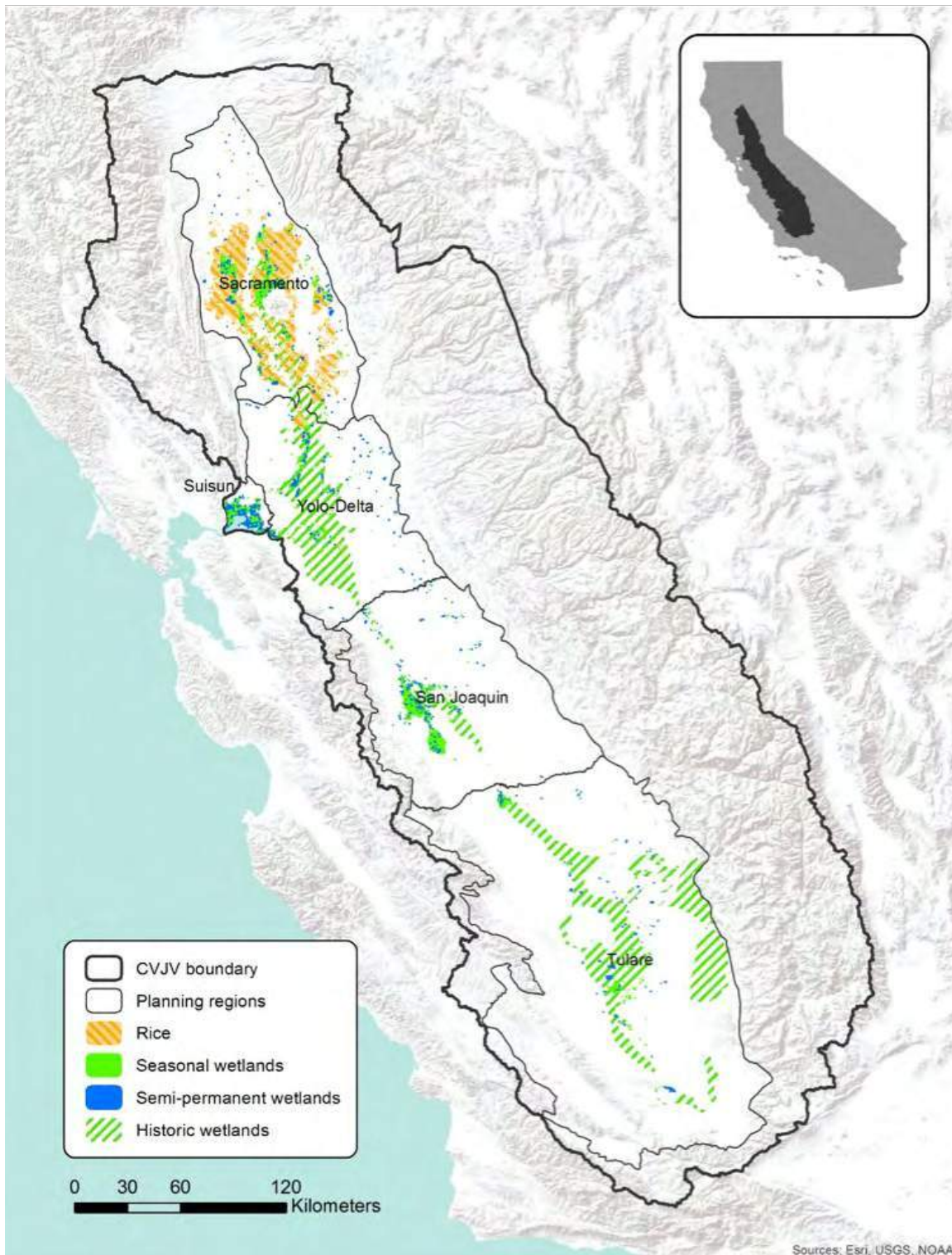

FIGURE 10.1 Central Valley Joint Venture perimeter and Primary Focus Area, showing estimated current extent of managed wetlands and rice agriculture and estimated historical (pre-1900) extent of wetlands.

CURRENT CONDITIONS

Current Population Sizes and Trends

To develop the long-term population objectives for each focal species in each planning region, the CVJV first developed a population status framework based on general principles of conservation and population biology (Dybala et al. 2017). The framework is structured as a hierarchy of four population size categories that mark milestones in becoming a genetically robust, self-sustaining, and ecologically functional population: very small (<1,000 individuals), small (<10,000 individuals), viable (>10,000 individuals), and large (>50,000 individuals). There are two additional modifiers, that describe steeply declining populations (>30 percent decline over 10 years), which are at high risk of extirpation regardless of population size, and resilient populations, which should be more capable of recovering from an environmental catastrophe in one part of the range if they have more than one self-sustaining sub-population.

Using this population-status framework, the CVJV characterized stilt populations as small (<10,000 individuals) or very small (<1,000 individuals) in three of the four planning regions, and avocet populations as small or very small in all four planning regions (Figure 10.2). Current population size estimates are based on surveys of the focal species in the Central Valley in 2003 (Shuford et al. 2007); there have been no comparable comprehensive surveys since. A local study of breeding shorebirds in the Glenn-Colusa Irrigation District of the Sacramento Valley in 2013 and 2014 provided the first estimates of breeding densities of killdeer in that region (Audubon California, unpublished data, 2016, see “Notes”); however, the current population size in the Central Valley is unknown. All three focal species show long-term (1968–2013) declining trends in the Coastal California Bird Conservation Region (BCR 32; Sauer et al. 2014). The population of killdeer shows a significant, steeply-declining trend of greater than 30 percent every 10 years, including during the most recent decade for which data were available (2004–2013; Figure 10.2; Strum et al. 2017).

Current Habitat

Breeding shorebirds use a variety of habitats in the Central Valley (Shuford et al. 2007). This Implementation Plan (hereafter, “the Plan”) focuses on semi-permanent managed wetlands, while accounting for breeding shorebird use of other habitats including rice fields, compensatory mitigation wetlands, sewage ponds, water storage facilities, evaporation ponds, and agricultural canals.

The CVJV estimated the total extent of current potential nesting habitat for breeding shorebirds in four planning regions of the Central Valley by evaluating the spatial extent



Black-necked stilt nest - Audubon California

of rice agriculture and semi-permanent wetlands (Figure 10.1). A Geographic Information Systems (GIS) data layer of Central Valley managed wetlands produced from 2009 satellite imagery (Petrik et al. 2014), supplemented by an estimate of the area of wetlands restored between 2009 and 2015 (D. Fehringer, personal communication, 2016, see “Notes”), was used to estimate a current (2015) total of 17,300 acres of semi-permanent wetlands. A current estimate of 541,400 acres of planted rice fields (averaged over 2007–2014) was derived from statewide survey statistics (NASS 2016) combined with a GIS layer representing the consistent spatial distribution of rice fields in California (The Nature Conservancy, unpublished data, 2015, see “Notes”).

Suitable nesting sites for the focal species generally include small islands or sparsely vegetated ground, adjacent to shallowly flooded foraging habitat (ranging from mudflat to 8 inches deep). These conditions need to persist for the duration of the nesting season for nesting to be successful. However, semi-permanent wetlands are generally managed as deep-water habitats, with areas of open water and patches of tall, dense vegetation (e.g., tules [*Schoenoplectus* spp.] and/or cattails [*Typha* spp.]) and with limited shallow areas, mainly along edges. Seasonal wetlands are typically drained in February and March, prior to or at the beginning of shorebird nesting. As a result, shallow-water habitat suitable for nesting is available only for a limited amount of time, if at all, during the shorebird breeding season (Iglecia and Kelsey 2012).

DEVELOPING THE CONSERVATION OBJECTIVES

Population Objectives

To meet the conservation goal, the overall long-term (100-year) population objectives for each focal species in the Central Valley Primary Focus Area was defined as large (>50,000 individuals), with viable (>10,000 individuals) sub-populations in each planning region.

Habitat and Density Objectives

Based on the estimated loss of over 90 percent of historical wetland habitat (Frayser et al. 1989) and the management strategies used on existing semi-permanent wetlands, populations of focal species are assumed to be currently limited by available habitat. Although surveys of breeding shorebirds in the Central Valley in 2003 found 80 percent of stilts and 66 percent of avocets in rice fields and managed wetlands combined (Shuford et al. 2007), habitat objectives were not set for rice fields because the extent of planted rice is strongly driven by changing economic and climatic conditions. Wetlands, by contrast, provide the greatest potential for increasing both long-term habitat availability and habitat quality through management actions.

After examining stilt and avocet breeding densities currently observed throughout the Central Valley, the CVJV estimated that a 50 percent increase in the overall average breeding density of each species in semi-permanent wetlands could be achieved through enhanced management of existing wetlands and restoration of wetlands with high-quality habitat. These estimates became the density and habitat objectives. It will be necessary to achieve both of these objectives in order to meet the population objectives, assuming no change to the numbers of individuals of each species breeding in rice fields or other habitat types.



Rice field suitable for nesting - Khara Strum

Current overall density estimates of breeding killdeer are lacking for the Central Valley. The species' density objective was estimated as the density of killdeer needed in semi-permanent wetlands to reach the population objective of more than 50,000 individuals, assuming no change to the number of killdeer breeding in rice fields (as extrapolated from the Glenn-Colusa Irrigation District) and assuming the habitat objective for stilts and avocets was met.

The objectives were distributed among the four planning regions to ensure each focal species reached a regional population threshold for a viable population (>10,000 individuals).

Additional details on the sources of data, methods, results, and references can be found in Strum et al. (2017).

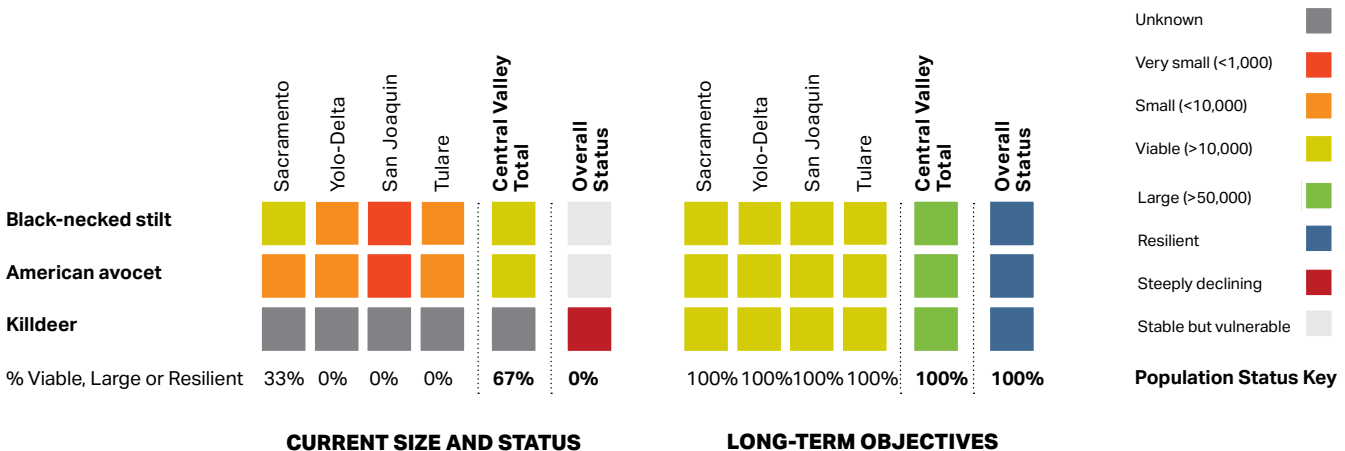

FIGURE 10.2 Population status and objectives for breeding shorebirds in the Central Valley.

CONSERVATION OBJECTIVES

Habitat Objectives

The Plan defines short-term (10-year) and long-term (100-year) habitat objectives for semi-permanent wetlands for each of the CVJV planning regions except Suisun (Table 10.2). These objectives reflect the estimated total extent of shorebird breeding habitat in semi-permanent wetlands required to achieve the long-term population objectives of all three focal species in each planning region.

Assuming no loss of existing semi-permanent wetland habitat, achieving long-term population objectives will require an estimated additional 285,000 acres of semi-permanent wetland habitat that is suitable for breeding shorebirds (meets the specific requirements for nesting and foraging) and is available during the peak breeding season (Table 10.2).

The corresponding short-term habitat objective for the Central Valley is an additional 28,500 acres of semi-permanent wetlands, distributed by planning region (Table 10.2). These objectives may also contribute to the habitat objectives for semi-permanent wetlands defined for other bird group such as breeding and non-breeding waterbirds and waterfowl (See the Conservation Delivery chapter for the integrated objectives).

Population Objectives

The long-term (100-year) population objective is to reach more than 50,000 individuals for each focal shorebird species within the CVJV's Primary Focus Area, with more than 10,000 individuals in each of four planning regions, during peak breeding season of mid-April through mid-July. These objectives represent the estimated population sizes needed to achieve genetically robust, self-sustaining, ecologically functional, and resilient populations.

Density Objectives

The density objectives represent the estimated average densities that could be reached with improvements in the quality of existing semi-permanent wetlands and in newly-restored semi-permanent wetlands in each planning region. Average densities needed to achieve long-term (100-year) population objectives for each CVJV planning region are 13.5 birds per 100 acres for avocets, 20.7 birds per 100 acres for stilts, and 14.0 birds per 100 acres for killdeer.

HABITAT TYPE PLANNING REGION	LONG-TERM HABITAT OBJECTIVE	CURRENT ESTIMATE	ADDITIONAL ACRES NEEDED (DIFFERENCE)	ACRES NEEDED BY 2030 (10%)
Semi-Permanent Managed Wetlands				
Sacramento	75,584	5,348	70,237	7,023
Yolo-Delta	75,584	4,011	71,574	7,159
San Joaquin	75,584	2,872	72,713	7,272
Tulare	75,584	5,034	70,551	7,055
Total	302,338	17,265	285,078	28,508

TABLE 10.2 Short-term (10-year) and long-term (100-year) habitat objectives for breeding shorebirds: semi-permanent managed wetlands. Shown in acres, with current estimates and the estimated additional acres needed to meet the habitat objectives by planning region. Habitat must be available during the peak breeding season, mid-April through mid-July. (Sums may not be exact, due to rounding in original data.)



Black-necked stilts - Dan Skalos

APPLYING THE CONSERVATION OBJECTIVES

Applying the Habitat Objectives

The long-term habitat objectives represent the estimated extent of semi-permanent wetlands required to be reliably flooded and managed annually to enable shorebird populations to meet the long-term population objectives, and therefore to reach the CVJV's conservation goal. Subtracting the estimated current extent of semi-permanent wetlands from the long-term habitat objective provides the estimated additional acres needed, assuming none of the current acreage is lost.

These additional acres can be gained by creating and flooding new semi-permanent wetlands, using 2015 as a starting point (the year of the most recent estimate of managed wetland acreage in the Central Valley). However, only the acreage of new wetlands that are flooded during peak shorebird nesting would count as contributing to the habitat objectives.

Although habitat objectives were defined only for semi-permanent wetlands, other types of wetlands could contribute to habitat objectives, such as reverse-cycle wetlands that are flooded in spring and summer and managed with relatively shallow water.

Progress toward achieving the habitat objectives for breeding shorebirds can be tracked through the CVJV's wetland restoration tracking database and by evaluating satellite imagery of surface water availability during mid-April through mid-July.

Enhancement of existing semi-permanent wetlands for breeding shorebirds may include adapting management practices to provide additional and higher-quality nesting and foraging habitat to support density objectives. The acreage of enhanced existing wetlands should not be counted toward the habitat objectives. Instead, habitat enhancement should be measured using the density objectives as described below.

Applying the Density Objectives

The density objectives can be used in several ways. At wetland restoration sites, density objectives can be used to measure whether the quality of the restored habitat is adequate to meet or exceed the density objectives for breeding shorebirds. Similarly, in existing habitat, density objectives can be used to demonstrate the effectiveness of habitat enhancement activities as densities of breeding shorebirds meet or exceed the density objectives. Finally, these objectives can be used as part of planning processes to project the potential number of individuals of each focal species that a restoration or enhancement project may be able to support. Progress toward the density objectives can be tracked through surveys of breeding shorebirds.

By increasing species densities, fewer acres of habitat are required to meet the population objectives, and in turn the CVJV's conservation goal. Therefore, improving conditions in existing wetland habitat should be a high priority. Habitat enhancement might include creating the specific nest-site characteristics needed by the three focal species (see Additional Conservation Considerations for details). Compensation wetlands in the Tulare Basin report numbers of birds that would exceed density objectives for each focal species (Davis et al. 2008) and could be considered as a complement to wetland restoration and enhancement after careful consideration of the benefits and drawbacks of this type of habitat. Short-term on-farm habitat programs implemented in rice agriculture (WHEP 2014) can also enhance breeding habitat and increase breeding densities in rice fields. Such enhancements likewise may reduce the area of semi-permanent wetlands needed to meet population objectives.



(1) American avocet nesting pair - Khara Strum (2) American avocet nest - Khara Strum

ADDITIONAL CONSERVATION CONSIDERATIONS

Consider foraging habitat for other water-dependent birds

In addition to providing habitat for breeding shorebirds, semi-permanent wetlands can also provide foraging habitat for other water-dependent birds, such as breeding and non-breeding waterbirds and waterfowl. For some of these birds, such as colonial nesting waterbirds, the amount of wetland habitat may not be as important as the location of the wetland within foraging distance of suitable nesting and roosting habitat, such as riparian forests. Wetland restorations that are strategically located near suitable riparian vegetation may contribute to the habitat objectives for both breeding shorebirds and other waterbirds. On the other hand, too close proximity to riparian or other vegetation may decrease overall use of wetlands by shorebirds if the vegetation hinders shorebirds' ability to detect aerial predators such as peregrine falcons.

Account for habitat needs of other wildlife

Enhancement of existing semi-permanent wetlands for breeding shorebirds may include changing management practices to provide more and higher-quality nesting habitat. These conditions need to persist for the duration of the breeding season for nesting to be successful. Other birds and wildlife may rely on semi-permanent wetlands as they are currently managed; assessing the potential trade-offs of changes in management strategies will be necessary.

Manage habitat for species-specific nesting requirements

In addition to a general strategy of restoring new and enhancing existing semi-permanent wetlands, habitat value can be added by providing the specific nest-site characteristics required by stilts, avocets, and killdeer. Stilts prefer to nest on small islands or on a mound above water (Robinson et al. 1999); avocets nest on dry, sparsely vegetated ground adjacent to shallow water (Ackerman et al. 2013); and killdeer nest on gravelly substrate near water or in upland habitats (Jackson and Jackson 2000). Slight differences in nest-site selection can have large effects on nest success and, therefore, on conservation measures needed for each species (Iglecia et al. 2014). Generally, suitable nesting sites for all focal species includes sparsely vegetated islands or high ground adjacent to shallowly flooded foraging habitat (ranging from mudflat to 8 inches deep). These conditions need to persist for the duration of the nesting season for nesting to be successful.



Island suitable for nesting, in a rice field - Monica Iglecia

Manage for landscape-level priorities

The distribution of habitat on the landscape may play an important role in meeting breeding shorebird population objectives. The Plan sets regional habitat objectives in order to meet regional population objectives (Table 10.2) for each focal species, allocating habitat evenly among the planning regions. Small adjustments can be made to where habitat is restored based on the feasibility of habitat restoration and/or the distribution of focal species most in need, as long as population objectives in each planning region are met. Despite the strong dispersal ability of shorebirds, the spatial distribution of habitat within each planning region may also affect habitat use (Reiter et al. 2015) and subsequent achievement of density and population objectives. The CVJV recommends creating and restoring habitat in areas that cluster habitat and maximize connectivity of semi-permanent wetlands and other shorebird breeding habitat.

(1) Black-necked stilt in flooded young rice field - California Rice Commission
(2) Female black-necked stilt and nest - Jim Dunn

SUCCESS STORY

TULARE BASIN WETLANDS

In the Tulare Basin, nearly 1,100 acres of semi-permanent wetlands have been supported on private lands through the Natural Resources Conservation Service's Wetland Reserve Program (now the Agricultural Conservation Easement Program) or the California Landowner Incentive Program. These programs provide technical and financial assistance to help landowners restore and manage wetlands, riparian areas, and grasslands for improved environmental quality, including wildlife habitat.

A subset of these restored wetlands, surveyed during peak shorebird breeding season from 2005 to 2008, hosted an average density of nine American avocets and 51 black-necked stilts per 100 acres. In contrast, the majority of lands in this region that once were wetlands have been converted to uses that do not provide any breeding shorebird habitat. These densities demonstrate that private lands can be managed effectively for breeding shorebird habitat.

Nearly 54 percent of shorebirds breeding on private wetlands are supported by private land conservation programs. Understanding how these private wetlands are managed could provide insights, leading to enhanced management of other private and public wetlands to increase breeding shorebird densities.



LITERATURE CITED

- Ackerman JT, Hartman CA, Herzog MP, Takekawa JY, Robinson JA, Oring LW, Skorupa JP, Boettcher R. 2013. American avocet (*Recurvirostra americana*). In: Poole A, editor. The Birds of North America Online, No. 275. Ithaca (NY): Cornell Lab of Ornithology. doi: 10.2173/bna.275
- Banks RC, Springer PF. 1994. A century of population trends of waterfowl in western North America. *Stud Avian Biol.* 15:134–146. Available from: https://sora.unm.edu/sites/default/files/journals/sab/sab_015.pdf
- [CVJV] Central Valley Joint Venture. 2006. Central Valley Joint Venture implementation plan - conserving bird habitat. Sacramento (CA): US Fish and Wildlife Service. 286 p. Available from: http://www.centralvalleyjointventure.org/assets/pdf/CVJV_fnl.pdf
- Davis DE, Hanson CH, Hansen RB. 2008. Constructed wetland habitat for American avocet and black-necked stilt foraging and nesting. *J Wildl Manag.* 72:143–151. doi: 10.2193/2005-553
- Dybala KE, Clipperton N, Gardali T, Golet GH, Kelsey R, Lorenzato S, Melcer Jr R, Seavy NE, Silveira JG, Yarris GS. 2017. A general framework for setting quantitative population objectives for wildlife conservation. *San Franc Estuary Watershed Sci.* 15(1):8.
- Fraye WE, Peters DD, Pywell HR. 1989. Wetlands of the California Central Valley: Status and trends 1939 to mid-1980's. Portland (OR): US Fish and Wildlife Service. 36 p. doi: 10.3996/012014-JFWM-003.S10
- Garone P. 2011. The fall and rise of the wetlands of California's great Central Valley. Berkeley (CA): University of California Press. 448 p.
- Halstead BJ, Wylie GD, Casazza ML. 2010. Habitat suitability and conservation of the giant garter snake (*Thamnophis gigas*) in the Sacramento Valley of California. *Copeia* 4:591–599. doi: 10.1643/CE-09-199
- Hickey C, Shuford WD, Page GW, Warnock S. 2003. Southern Pacific shorebird conservation plan: A strategy for supporting California's Central Valley and coastal shorebird populations. Version 1.1. Stinson Beach (CA): PRBO Conservation Science. 137 p. Available from: http://www.prbo.org/cms/docs/wetlands/SPSCPlan_010904.pdf
- Iglecia MN, Kelsey R. 2012. Assessing the scope and scale of shorebird friendly management practices on managed wetlands in the Central Valley of California. Sacramento (CA): Audubon California.
- Iglecia MN, Velas KL, Kelsey TR, Dhundale JA, Shake CS, Hardy MA. 2014. Year 2 Summary of shorebird nesting habitat enhancement study. Sacramento (CA): Audubon California.
- Jackson BJ, Jackson JA. 2000. Killdeer (*Charadrius vociferus*). In: Poole A, editor. The Birds of North America Online, No 517. Ithaca (NY): Cornell Lab of Ornithology. doi: 10.2173/bna.517
- Liu X, Taylor LO, Hamilton TL, Grigelis PE. 2013. Amenity values of proximity to National Wildlife Refuges: An analysis of urban residential property values. *Ecol Econ.* 94:37–43. doi: 10.1016/j.ecolecon.2013.06.011
- [NASS] National Agricultural Statistics Service. 2016. Quick Stats 2.0. U.S. Department of Agriculture. Available from: <http://quickstats.nass.usda.gov/>
- Page GW, Gill RE Jr. 1994. Shorebirds in western North America: Late 1800s to late 1900s. *Stud Avian Biol.* 15:147–160. Available from: https://sora.unm.edu/sites/default/files/journals/sab/sab_015.pdf
- Petrik K, Fehring D, Weverko A. 2014. Mapping seasonal managed and semi-permanent wetlands in the Central Valley of California. Rancho Cordova (CA): Ducks Unlimited, Inc.
- Reiter ME, Wolder MA, Isola JE, Jongsomjit D, Hickey CM, Carpenter M, Silveira JG. 2015. Local and landscape habitat associations of shorebirds in wetlands of the Sacramento Valley of California. *J Fish Wildl Manag.* 6:29–43. doi: 10.3996/012014-JFWM-003
- Robinson JA, Reed JM, Skorupa JP, Oring LW. 1999. Black-necked stilt (*Himantopus mexicanus*) In: Poole A, editor. The Birds of North America Online, No 449. Ithaca (NY): Cornell Lab of Ornithology. doi: 10.2173/bna.449
- Sauer JR, Hines JE, Fallon JE, Pardieck KL, Ziolkowski DJ Jr, Link WA. 2014. The North American breeding bird survey, results and analysis 1966–2013. Version 01.30.2015. Laurel (MD): USGS Patuxent Wildlife Research Center. Available from: <http://www.mbr-pwrc.usgs.gov/bbs/bbs.html>
- Shuford WD, Humphrey JM, Hansen RB, Page GW, Stenzel LE, Hickey CM. 2007. Summer distribution, abundance and habitat use of black-necked stilts and American avocets in California's Central Valley. *West Birds.* 38:11–28. Available from: [https://www.westernfieldornithologists.org/archive/V38/38\(1\)%20p0011-p0028.pdf](https://www.westernfieldornithologists.org/archive/V38/38(1)%20p0011-p0028.pdf)
- Strum KM, Dybala, KE, Iglecia MN, Shuford WD. 2017. Population and habitat objectives for breeding shorebirds in California's Central Valley. *San Franc Estuary Watershed Sci.* 15(1):3.
- [USFWS] U.S. Fish and Wildlife Service, US Department of the Interior and US Department of Commerce, US Census Bureau. 2014. 2011 National survey of fishing, hunting, and wildlife associated recreation. Available from: <http://www.census.gov/prod/2012pubs/fhw11-nat.pdf>
- [USSCPP] US Shorebird Conservation Plan Partnership. 2015. US Shorebirds of Conservation Concern, 2015, U.S. Fish and Wildlife Service, Division of Migratory Bird Management, Falls Church, Virginia. Available from <https://www.shorebirdplan.org/wp-content/uploads/2015/01/ShorebirdsConservationConcernJan2015.pdf>. 2016 update available from: <http://www.shorebirdplan.org/science/assessment-conservation-status-shorebirds>
- [WHEP] Waterbird Habitat Enhancement Program. 2014. Bird-friendly farming in California rice fields: A model of collaboration benefitting birds and people. 24p. Available from: http://calrice.org/pdf/waterbirdhabitatbro_web.pdf

NOTES

- Audubon California. 2016. Nesting study data. Excel (.xls) file. Located at 400 Capitol Mall, Suite 1535, Sacramento, CA 95814. Available from: kstrum@audubon.org.
- Fehring D. 2016. Email communication to K. Dybala regarding estimates of wetland acres restored between 2009 and 2015 in the Central Valley.
- The Nature Conservancy. 2015. Suitable agriculture GIS layer, developed from the remotely-sensed CropScape Cropland Data Layer provided by the U.S.D.A. National Agricultural Statistics Service and processed to include only pixels that were consistently classified into one of several major crop classes in the majority of the years 2007–2014. Available from: [Rodd Kelsey, rkelsey@tnc.org](http://roddkelsey.com).



1

BREEDING AND NON-BREEDING WATERBIRDS

11



2



3

CHAPTER SUMMARY

Central Valley wetlands play a vital role for North American waterbirds and provide a multitude of benefits to people. Although less than 10% of the Central Valley's historical wetland acreage remains, this region still supports populations of a diverse array of waterbird species.

This chapter describes the conservation objectives for the restoration and enhancement of wetlands, flooded croplands, and adjacent riparian forest needed to support robust populations of waterbird species in the Central Valley. The goal is to reverse historical population declines of these species. The chapter uses population objectives for a group of 10 representative species to determine overall habitat needs for waterbirds.

The Conservation Delivery chapter in Section I integrates these habitat objectives with the habitat objectives for other bird groups in the Implementation Plan to present total habitat needs in the Central Valley. The chapter then describes conservation actions for achieving these integrated habitat objectives.

HABITAT TYPE

Waterbirds in the Central Valley use a wide variety of habitat types, but mainly semi-permanent and seasonally flooded wetlands, postharvest-flooded rice and corn fields, and adjacent riparian forests. Within these habitats, various bird species may respond differently to particular water depths, vegetation structure and extent, season of flooding, degree of human presence, and other factors.

WATERBIRD HABITAT ACREAGE

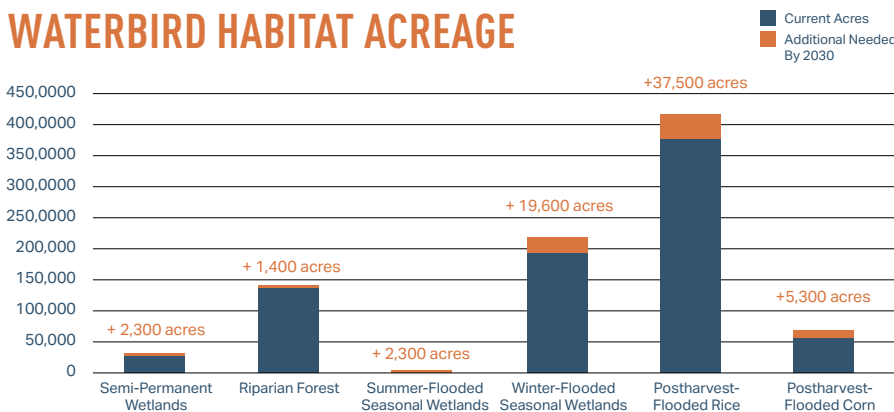

HABITAT SUCCESS STORIES

since the 2006 Implementation Plan

Stone Lakes National Wildlife Refuge provides important foraging and roosting habitat for greater and lesser sandhill cranes during their non-breeding season. Progress over the last decade includes:

- 240 acres of suitable crane habitat added to the refuge
- Habitat enhancement completed for 80 acres of wetlands
- Number of cranes has increased: from two cranes in 1999, to 710 in 2010, to more than 1000 roosting cranes in 2015

**SHORT-TERM OBJECTIVE
(CURRENT + ADDITIONAL):**

**869,300 ACRES
OF HIGH-QUALITY
WATERBIRD HABITAT**

WHAT'S NEEDED?:

**68,300
ADDITIONAL ACRES**

BIRD SPECIES INCLUDE:

Representative waterbird species in the Central Valley:

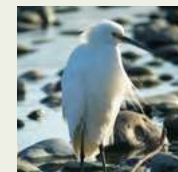

Snowy egret*

Species of heightened conservation concern:



Eared grebe**

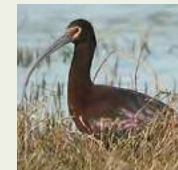

White-faced ibis*



Forster's tern**



Sandhill crane***



Black rail****

*Image: Brian Gilmore **Image: Tom Grey ***Image: Steve J. McDonald ****Image: Philip Robertson

(1) Snowy egret - Tom Grey (2) Central Valley wetlands - Anders Ericsson and Lighthawk (3) Western grebe - Tom Grey

INTRODUCTION

Historically, the Central Valley supported a diverse and abundant community of wetland-dependent birds, including waterfowl, shorebirds, and a group referred to here as waterbirds. This group includes loons, grebes, pelicans, cormorants, herons, egrets, night-herons, rails, coots, cranes, gulls, and terns. Despite the loss of more than 90 percent of its historical wetlands (Frayer et al. 1989), the Central Valley remains of continental importance for waterbirds (Shuford 2014a; Shuford 2014b), many of which have special conservation status at either the state or federal level.

Waterbirds in the Central Valley use a wide variety of habitats, including managed and tidal wetlands, agricultural lands, riparian forest, and a range of water bodies. Protecting, restoring, and enhancing these habitats for waterbirds will also provide habitat for a broad suite of other animals and plants. These actions can also benefit people in surrounding communities by reducing flood risk, improving air and water quality, recharging groundwater, sequestering carbon, providing recreational opportunities, and attracting wildlife watchers who help support local economies.

In addition to facing habitat loss and degradation, waterbirds across North America are subject to a wide range of other threats, including contaminants, disease, and non-native predators. Sea-level rise and increasing prevalence of drought and other extreme weather patterns projected for the 21st century also threaten waterbirds (Kushlan et al. 2002; Shuford 2014a). The North American Waterbird Conservation Plan (Kushlan et al. 2002) provides a continental vision for the conservation of waterbirds. The Coastal California (BCR 32) Waterbird Conservation Plan, which encompasses the Central Valley in addition to central and southern coastal California (Shuford 2014a), provides regional conservation goals and objectives. These plans helped guide the development of the CVJV's conservation goals and objectives for breeding and non-breeding waterbirds.

The CVJV has established conservation objectives for habitat restoration and enhancement and for target population sizes of a representative suite of waterbird species. Improving and increasing habitat for these species will provide widespread benefits for waterbirds of all kinds in the region. This chapter explains these conservation objectives and how they can be applied to reach the conservation goals.

CONSERVATION GOAL

The Central Valley Joint Venture's long-term goals are to restore and enhance more waterbird habitat in the Central Valley and to reverse historical declines of waterbird populations in this region.



(1) White-faced ibis flock - Sara Miller (2) Sandhill cranes flying over wetlands - Tom Grey

WHICH SPECIES ARE INCLUDED?

The conservation objectives focus on 10 waterbird species that occur regularly in the Central Valley during either the breeding or non-breeding season (Table 11.1). These include eight species of heightened conservation concern and two additional species (snowy egret and white-faced ibis) chosen for additional representation of key habitat attributes. These focal species collectively represent the habitat needs of a broad range of waterbird species in this region. Managing habitat to support local populations of these species will likewise support diverse and healthy ecosystems (Chase and Geupel 2005).



American white pelican - Tom Grey

SPECIES (SCIENTIFIC NAME)	CONSERVATION STATUS ^a	HABITAT ASSOCIATIONS	
		BREEDING SEASON (MARCH – JULY)	NON-BREEDING SEASON
Eared grebe (<i>Podiceps nigricollis</i>)	WCP-32, NAWCP	Semi-permanent and summer-flooded seasonal wetlands	Semi-permanent and seasonal wetlands
Western grebe (<i>Aechmophorus occidentalis</i>)	WCP-32, NAWCP	Semi-permanent wetlands	Semi-permanent wetlands
California black rail (<i>Laterallus jamaicensis</i>)	ST, BCC, WCP-32, NAWCP	Semi-permanent wetlands	Semi-permanent wetlands
Sandhill crane (<i>Antigone canadensis</i>)	ST ^b , BSSC ^c , WCP-32	NA	Forages in postharvest dry and flooded corn and rice, other cereal grains, alfalfa, pasture, and seasonal wetlands. Nighttime roosts are in shallowly flooded seasonal wetlands and agricultural fields.
Black tern (<i>Chlidonias niger</i>)	BSSC, WCP-32, NAWCP	Rice and summer-flooded seasonal wetlands	NA
Forster's tern (<i>Sterna forsteri</i>)	WCP-32, NAWCP	Semi-permanent and summer-flooded seasonal wetlands	NA
American white pelican (<i>Pelecanus erythrorhynchos</i>)	BSSC, NAWCP	NA	Semi-permanent wetlands
Least bittern (<i>Ixobrychus exilis</i>)	BSSC, WCP-32, NAWCP	Semi-permanent wetlands	NA
Snowy egret (<i>Egretta thula</i>)	NAWCP	Nests in riparian forest (or residential trees); forages in semi-permanent and summer-flooded seasonal wetlands, rice, and other irrigated crops and pasture	Roosts in riparian forest; forages in semi-permanent and seasonal wetlands, postharvest-flooded rice, and other irrigated crops and pasture
White-faced ibis (<i>Plegadis chihii</i>)		Nests in semi-permanent wetlands; forages in semi-permanent and summer-flooded seasonal wetlands, rice, alfalfa, and other irrigated crops and pasture	Roosts in semi-permanent and seasonal wetlands; forages in semi-permanent and seasonal wetlands, postharvest-flooded rice, alfalfa and other irrigated or flooded crops and pasture

^a Conservation status designations: ST, state threatened species (CDFW 2016); BSSC, California Bird Species of Special Concern (Shuford and Gardali 2008); BCC, U.S. Fish and Wildlife's Birds of Conservation Concern (USFWS 2008); WCP-32, species ranked as of high or moderate concern in the Coastal California Waterbird Conservation Plan (Shuford 2014a); NAWMP, species ranked as of highest, high, or moderate concern by the North American Waterbird Conservation Plan (Kushlan et al. 2002).

^b State threatened status is for the greater sandhill crane (*Antigone canadensis tabida*).

^c Bird species of special concern status is for the lesser sandhill crane (*Antigone canadensis canadensis*).

NA: Not Applicable

TABLE 11.1 Waterbird focal species: Conservation status and habitat associations during the breeding and non-breeding seasons.

WHICH GEOGRAPHIC AREAS ARE INCLUDED?

Conservation objectives were defined for each of the five planning regions in the CVJV's Primary Focus Area (Figure 11.1).

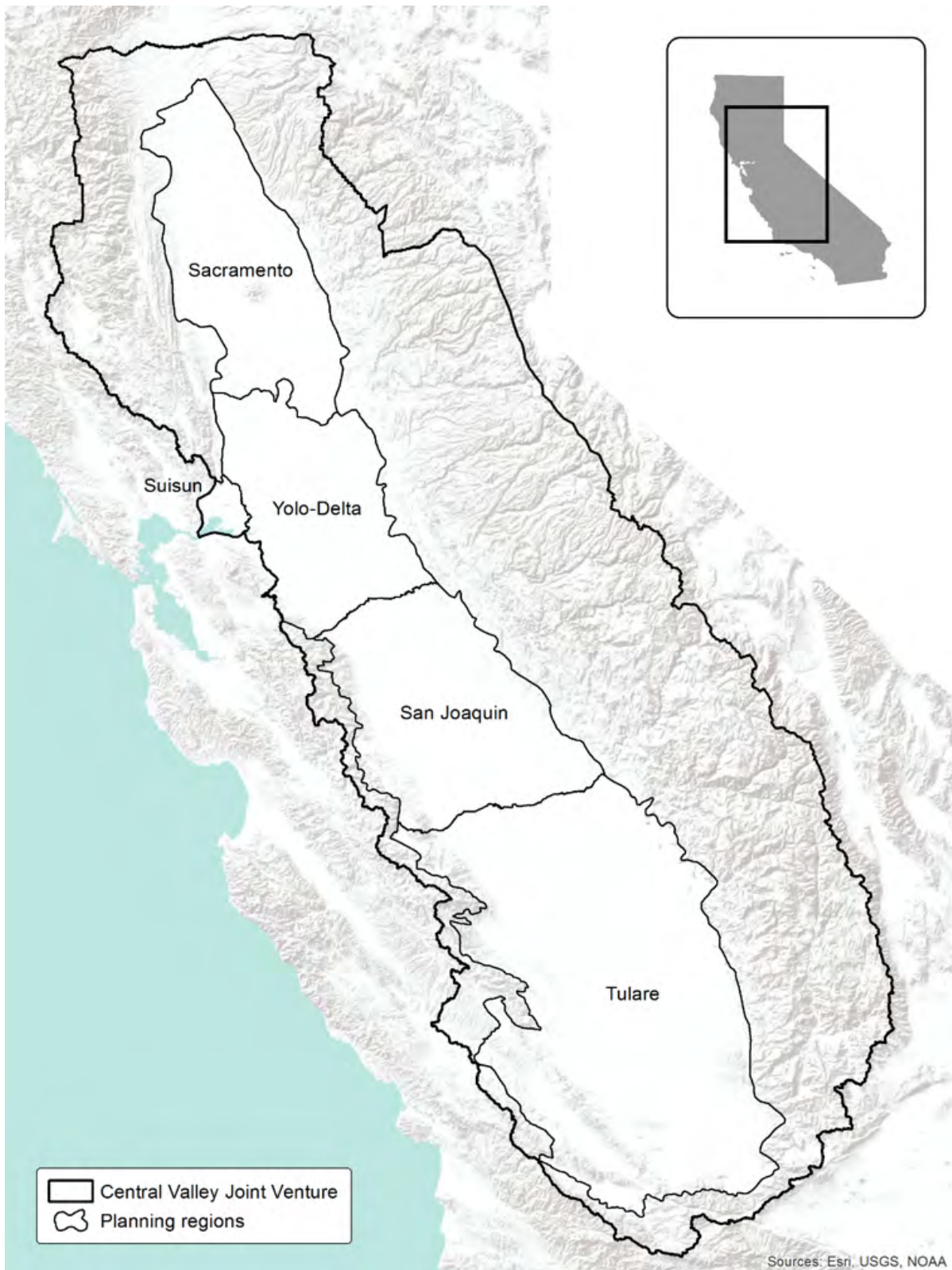

FIGURE 11.1 Central Valley Joint Venture perimeter and Primary Focus Area, showing the five planning regions.

CURRENT CONDITIONS

Current Population Sizes and Trends

The current population sizes and trends of many waterbird species in the Central Valley are unknown. Recent (2010–2012) censuses of colonial nesting waterbirds throughout California (Shuford 2014b) provide data for five of the 10 focal species. These surveys estimated a total of only five breeding pairs of eared grebes and 16 pairs of Forster’s terns, versus 755, 996, and 18,005 pairs of snowy egrets, black terns, and white-faced ibis, respectively. The numbers of nesting black and Forster’s terns were well below those recorded in the Central Valley in 1998 (Shuford et al. 2016). The reasons for these changes are unknown but likely reflect the effects of recent drought conditions rather than a long-term trend. Waterbird populations in the Central Valley may vary substantially between years with variation in habitat availability, particularly during the breeding season. The CVJV did not find any recent, comparable population size estimates for Central Valley waterbirds during the non-breeding season.

Current Habitat Conditions

The habitat types currently available to waterbirds in the Central Valley vary seasonally and spatially. During the breeding season, these include an estimated total of 22,800 acres of semi-permanent managed wetlands and 141,600 acres of riparian forest (Table 11.2). Some of the riparian forest is located near suitable waterbird foraging habitat and provides nesting substrate for colonies of breeding herons, egrets, night-herons, and cormorants. Researchers also estimated a 2007–2014 average of 541,400 acres of cultivated rice fields, 94 percent of which falls in the Sacramento planning region. The rice fields provide potential nesting habitat for black terns and foraging

habitat for white-faced ibis, egrets, herons, and night-herons.

During the non-breeding season, available habitat types for foraging and roosting include many of the same types available during the breeding season, as well as winter-flooded seasonal wetlands and postharvest-flooded crops. There were an estimated total of 196,400 acres of winter-flooded seasonal wetlands in 2015, concentrated in the Sacramento and San Joaquin planning regions (Table 11.3). Of the 541,400 acres of planted rice, approximately 374,600 acres (69 percent) have open water during the peak of postharvest flooding in early January (Table 11.4). Similarly, there were an estimated 2007–2014 average of 227,600 acres of planted corn in the Yolo-Delta region, of which approximately 52,800 acres (23 percent) have open water during the peak of postharvest flooding in early February. Other suitable crop types planted in the Central Valley add another 2.8 million acres of potential waterbird habitat, depending on the extent and timing of irrigation and any postharvest flooding. These crops include alfalfa, irrigated pasture, field and row crops, and other grains such as winter wheat, triticale, and barley (Table 11.4). However, the estimated peak area of field and row crops and other grains that were flooded, on average, between 2007 and 2011 was just three percent (Dybala et al. 2017).

The assessment of current existing habitat acreage does not include estimates for habitat types not included in the objectives, such as alfalfa, irrigated pasture, various grain crops, field and row crops, flood-water storage or recharge facilities, freshwater reservoirs, lakes, ponds, and agricultural evaporation and wastewater treatment ponds.



DEVELOPING THE CONSERVATION OBJECTIVES



Population Objectives

Historical population sizes and long-term trends of waterbirds in the Central Valley are unknown. Because at least 90 percent of the Central Valley's historical wetlands have been lost, most waterbird species are likely to have experienced population declines of at least 50 percent over the last 100 years. Therefore, to meet the goal of reversing the impacts of these historical wetland losses, this Implementation Plan (hereafter, "the Plan") set long-term (100-year) conceptual population objectives of doubling the current population sizes (100 percent increase) of most of the waterbird focal species. The corresponding short-term (10-year) objective is to increase population sizes by 10 percent. For species estimated to have relatively very small populations (fewer than 500 breeding individuals), namely the eared grebe and Forster's tern, the long-term objective was increased to tripling current population sizes (200 percent increase), with a corresponding 20 percent increase over the short-term. For the white-faced ibis, which is estimated to have a relatively large population (>20,000 individuals) and an increasing population trend (Shuford et al. 1996; Shuford 2014b), the Plan defined long- and short-term objectives of maintaining current population sizes.

Habitat Objectives

Waterbirds use a wide range of habitat types in the Central Valley. For this Plan, habitat objectives were defined for the six habitat types with the highest

potential for restoration and enhancement: semi-permanent wetlands, riparian forest, summer-flooded seasonal wetlands, winter-flooded seasonal wetlands, postharvest-flooded rice, and postharvest-flooded corn.

The Plan does not call for the creation or enhancement of new lakes, ponds, reservoirs, rivers, or agricultural canals, or for crops (e.g., alfalfa, irrigated pasture, summer-flooded growing rice) for which there appears to be limited capacity or opportunity to increase their extent or enhance their suitability for waterbirds. The Plan also recognizes that the extent of cultivated rice and other crops will vary according to market forces and climatic conditions (e.g., drought). In addition, habitat objectives were not defined for nesting habitat in evaporation ponds or waste-water treatment ponds due to concerns about contaminants and disease. There still may be conservation opportunities in each of these habitat types, however, such as enhancing nesting habitat for grebes in lakes, ponds, and reservoirs (Table 11.5).

Short-term habitat objectives were defined by hypothesizing that meeting the short-term population objective of a 10 percent increase in most of the populations of waterbird focal species would likely require a 10 percent increase in the total area of each of the six key habitat types. Further research will be required to test this hypothesis by quantifying current waterbird population sizes and tracking whether increases in habitat directly correspond to increases in population size. In the meantime, short-term habitat objectives were defined as a 10 percent increase (acres needed) for most key habitat types. Because summer-flooded seasonal wetlands are currently rare and their extent unknown, the short-term habitat objective for this cover type was set to be equivalent to the acres needed for semi-permanent wetlands. In addition,

because the specific location of riparian vegetation is more limiting than its total acreage, the habitat objective for riparian forests was set as a 1 percent increase, that should be strategically located adjacent to waterbird foraging habitat.

Portions of each habitat objective were then assigned to each of the five planning regions. For winter-flooded seasonal wetlands and postharvest-flooded rice and corn, these were simple 10 percent increases in the existing habitat estimated for each region. For semi-permanent wetlands, riparian vegetation, and summer-flooded seasonal wetlands, larger proportions of the overall habitat objective were assigned to the San Joaquin and Tulare planning regions, where there is the greatest need for improvement. In addition, objectives for more extensive increases in semi-permanent and summer-flooded seasonal wetlands in these planning regions will benefit eared grebes and Forster's terns, the two focal species with very small breeding populations and the most ambitious relative population objectives.

Extending this general approach leads to the assumption that meeting the long-term objectives of doubling the populations of most waterbird focal species would require long-term habitat objectives of doubling the extent of corresponding habitats. At this time, however, the Plan is focusing only on the short-term habitat objectives, given the uncertainty in the current population sizes and trends of the focal species and in the relationship between increases in habitat and increases in waterbird population size.

Additional details on the sources of data, methods, results, and references relative to setting conservation objectives for waterbirds in the Central Valley can be found in Shuford and Dybala (2017).

(1) White-faced ibis flock - R. McLandress (2) Fledgling Forster's tern - Tom Grey

CONSERVATION OBJECTIVES

Habitat Objectives

The Plan defines short-term (10-year) habitat objectives for each of six key habitat types used by waterbirds during either the breeding or non-breeding seasons for nesting, roosting, and/or foraging (Tables 11.2 and 11.3). These objectives represent the estimated total extent of each habitat type required to meet the short-term population objectives.

The key waterbird habitat types include:

- Semi-permanent wetlands, used year-round for nesting, roosting, and foraging. Some of these target increases are in addition to the wetland habitat objectives for waterfowl and shorebirds.
- Riparian forest, used year-round for nesting and roosting during the breeding season and roosting during the non-breeding season. These objectives are not in addition to the objectives for riparian landbirds, but should be strategically placed adjacent to waterbird foraging habitat (i.e., wetlands and irrigated crops and pasture).
- Summer-flooded seasonal wetlands (also called “reverse-cycle” wetlands), used during the breeding season for nesting, foraging, and roosting. These objectives may have to be increased to account for year-to-year fluctuations in availability of this habitat type (see Applying the Conservation Objectives).
- Winter-flooded seasonal wetlands, used during the non-breeding season for roosting and foraging.
- Postharvest-flooded rice and corn fields, used during the non-breeding season for roosting and foraging. The objectives for these two habitat types assume no change in the average annual extent of rice and corn planted (Table 11.4), but rather an enhancement of these cover types by increasing the proportion that is flooded postharvest.



Gray Lodge Wildlife Area - Brian Gilmore

HABITAT TYPE PLANNING REGION	SHORT-TERM HABITAT OBJECTIVE	CURRENT ESTIMATE	ACRES NEEDED BY 2030 (difference)
Semi-Permanent Wetlands			
Sacramento	5,575	5,348	228
Yolo-Delta	4,238	4,010	228
Suisun	5,722	5,494	228
San Joaquin	3,668	2,872	796
Tulare	5,830	5,034	796
Total	25,033	22,758	2,276
Riparian Forest			
Sacramento	70,022	67,897	213
Yolo-Delta	34,995	32,869	213
Suisun	1,408	0	141
San Joaquin	29,198	24,949	425
Tulare	20,144	15,893	425
Total	155,768	141,608	1,416
Summer-Flooded Seasonal Wetlands^a			
Sacramento	228	–	228
Yolo-Delta	228	–	228
Suisun	0	–	0
San Joaquin	682	–	682
Tulare	1,138	–	1,138
Total	2,276	–	2,276

^a Although there do not appear to be any estimates for the extent or distribution of summer seasonal wetlands in the Central Valley, this type of wetland generally appears to be rare in the region overall.

TABLE 11.2 Short-term (10-year) habitat objectives for waterbirds: year-round or breeding season. Breeding season is mainly March–July. Objectives (in acres) are shown by planning region along with current estimates of each habitat type and the estimated additional acres needed to meet the habitat objectives. (Sums may not be exact, due to rounding in original data.)

HABITAT TYPE PLANNING REGION	SHORT-TERM HABITAT OBJECTIVE	CURRENT ESTIMATE	ACRES NEEDED (DIFFERENCE)
Winter-Flooded Seasonal Wetlands			
Sacramento	75,344	68,495	6,849
Yolo-Delta	24,150	21,955	2,195
Suisun	31,628	28,752	2,876
San Joaquin	64,213	58,375	5,837
Tulare	20,718	18,834	1,884
Total	216,053	196,411	19,641
Postharvest-Flooded Rice			
Sacramento	391,395	355,814	35,581
Yolo-Delta	20,690	18,809	1,881
Suisun	0	0	0
San Joaquin	0	0	0
Tulare	0	0	0
Total	412,085	374,623	37,462
Postharvest-Flooded Corn			
Sacramento	0	0	0
Yolo-Delta	58,084	52,804	5,280
Suisun	0	0	0
San Joaquin	0	0	0
Tulare	0	0	0
Total	58,084	52,804	5,280

TABLE 11.3 Short-term (10-year) habitat objectives for waterbirds: Non-breeding season. Objectives (in acres) are shown by planning region, along with current estimates of the peak availability of each habitat type during the non-breeding season and the estimated additional amount needed to meet the habitat objectives. For postharvest-flooded rice and corn, the peak availability is less than the total extent planted (Table 11.4) because it includes only the proportion that has open water during the non-breeding season. Note that objectives for semi-permanent wetlands and riparian vegetation (Table 11.2) also contribute to habitat during the non-breeding season. (Sums may not be exact, due to rounding in original data.)

PLANNING REGION	RICE	CORN	ALFALFA	IRRIGATED PASTURE	OTHER GRAINS	FIELD AND ROW CROPS
Sacramento	509,873	33,350	47,274	24,083	75,960	135,389
Yolo-Delta	26,953	227,626	162,887	24,950	162,395	176,283
Suisun	0	17	220	1,737	4,407	154
San Joaquin	4,536	143,178	176,839	35,818	127,444	334,006
Tulare	0	202,761	251,693	67,937	352,854	687,365
Total	541,362	606,932	638,915	154,525	723,061	1,333,198

TABLE 11.4 Estimated total area of crops potentially compatible for waterbird habitat. Estimates (in acres) shown by planning region and for crops that could be used by waterbirds, depending on the extent and timing of flooding or other management efforts. The estimate for irrigated pasture is from 2013; all other estimates represent the 2007–2014 average. (Sums may not be exact, due to rounding in original data.)

Population Objectives

The Plan defines long-term (100-year) population objectives of doubling (100 percent increase) the population sizes of most of the focal species; tripling (200 percent increase) populations of the eared grebe and Forster’s tern, and maintaining the current population sizes of the white-faced ibis. Corresponding short-term (10-year) objectives are increases of 10 percent and 20 percent for the grebe and tern, respectively, and no increase for the ibis. These objectives represent current estimates of the population sizes needed to achieve the goal of reversing the impacts of historical habitat losses and degradation on waterbird populations in the Central Valley. However, these population objectives are not currently quantifiable because the current population sizes of many waterbird species in the Central Valley are unknown. Thus, these population objectives are solely conceptual, used to estimate the increase in habitat required to double or triple current population sizes.

APPLYING THE CONSERVATION OBJECTIVES

Habitat Objectives

Because the understanding of waterbird population sizes and dynamics is uncertain, the Plan focuses on short-term objectives. For the flooded habitat types, the objectives represent the total extent that will need to be reliably flooded every year by the end of the 10-year period, i.e., current acres plus additional acres needed, assuming none of the current acreage is lost. These additional acres can be achieved through restoration and, in some cases, through enhancement as described below.

For the purposes of this Plan, “habitat restoration” means conversion of land that does not currently consist of the target land cover type into that cover type. For seasonal and semi-permanent wetlands, this includes creating and flooding new wetlands (measured from 2015, the most recent estimate for the extent of Central Valley managed wetlands). For riparian forest, this includes establishing new areas with native riparian-associated shrubs and trees (measured from 2012, the year of the most recent riparian vegetation GIS layer). The acreage of new wetlands that are reliably flooded, and new riparian habitat created by a restoration project adjacent to waterbird foraging habitat, would both count as contributing to the waterbird habitat objectives.

“Habitat enhancement,” in this situation, indicates increasing the extent of flooding of existing habitat, making it more available and more useful to waterbirds. For rice and corn, this includes increasing the proportion of planted croplands that are regularly flooded postharvest.

Similarly, the additional acres of summer-flooded seasonal wetlands can be met through restoration or by opportunistically flooding dormant wetlands or fallow agricultural fields in years of exceptional runoff (when water is freely available). Managing summer-flooded seasonal wetlands can be costly due to high evaporation rates, rapid vegetation growth, and mosquito abatement. Therefore, it may be more feasible to provide summer seasonal wetlands opportunistically. In this case, the habitat objectives for summer seasonal wetlands should be increased to make up for the lack of this habitat type in most years. For example, if such conditions occur only once every 10 years, the habitat objectives would be increased 10-fold.



Suisun Marsh - Steve Martarano/USFWS

The CVJV can track overall progress toward the semi-permanent and seasonal wetland objectives through a combination of tracking wetland restoration projects and recording satellite imagery of surface water to estimate the area flooded. Similarly, progress toward the postharvest-flooded rice and corn objectives can be tracked through a combination of National Agricultural Statistics Service surveys and satellite imagery of surface water. Overall progress toward the riparian habitat objectives can be tracked through updates to California Department of Fish and Wildlife vegetation GIS layers (http://www.dfg.ca.gov/biogeodata/bios/dataset_index.asp).

(1) Greater sandhill crane - Steve J. McDonald (2) Lesser sandhill cranes - Bruce Miller, Elk Grove, CA (3) Birdwatchers - Shelley Hammon

SUCCESS STORY



SANDHILL CRANE FESTIVAL

Every year in November, thousands of visitors make their way to public wetlands and private farmlands around Lodi, California to see overwintering migratory birds. The annual festival is timed to coincide with the arrival of thousands of sandhill cranes from their long migratory journey from nesting grounds as far away as Siberia. The cranes remain in the Central Valley through February.

Since 1996, the Lodi Sandhill Crane Festival has helped to promote bird and wetland conservation and connect people with nature in the Central Valley. Significantly, the event also brings an influx of dollars to the area, as bird- and wildlife-watchers pay for hotels, meals and local transportation and support local artists, in addition to paying for the various festival events. This consumer activity provides an incentive to area landowners and voters to protect crane habitat.

The CVJV is one of numerous sponsors of the Lodi Sandhill Crane Festival. This annual event showcases the private/public partnerships that are key to meeting the goals of the CVJV Implementation Plan.



ADDITIONAL CONSERVATION CONSIDERATIONS

Manage habitat for species-specific needs

In addition to meeting the habitat objectives for each of the key waterbird habitat types, achieving the CVJV's long-term goals will require providing specific habitat features required by individual waterbird species. Such requirements may include a particular combination of vegetation cover, water depth, timing of flooding and water level stability, or proximity of foraging habitat to roosting or nesting sites (Table 11.5). For example, American white pelicans require extensive open water ranging from 1 to 8 feet deep with robust fish populations for foraging, whereas

California black rails require wetlands with shallow water (less than 1.2 inches deep) and dense vegetation cover.

Also, habitat requirements for particular species may vary among geographic regions of the Central Valley. Consequently, the Plan makes species-specific conservation recommendations that sometimes vary by planning region (Table 11.5). For example, at least half of the wetland habitat acreage in the Sacramento and Yolo-Delta planning regions should have features suitable for black rails, and at least half of the habitat acreage in the Sacramento, San Joaquin, and Tulare planning regions

should have features suitable for western grebes or Forster's terns. These specific habitat features do not overlap extensively with those needed by most waterfowl and shorebirds.

Half of the additional semi-permanent wetlands created to meet the habitat objective for each planning region should have features specifically suitable for particular waterbird species. Meeting the needs of all of these waterbird species will likely require coordination of restoration, enhancement, and management across the Central Valley.

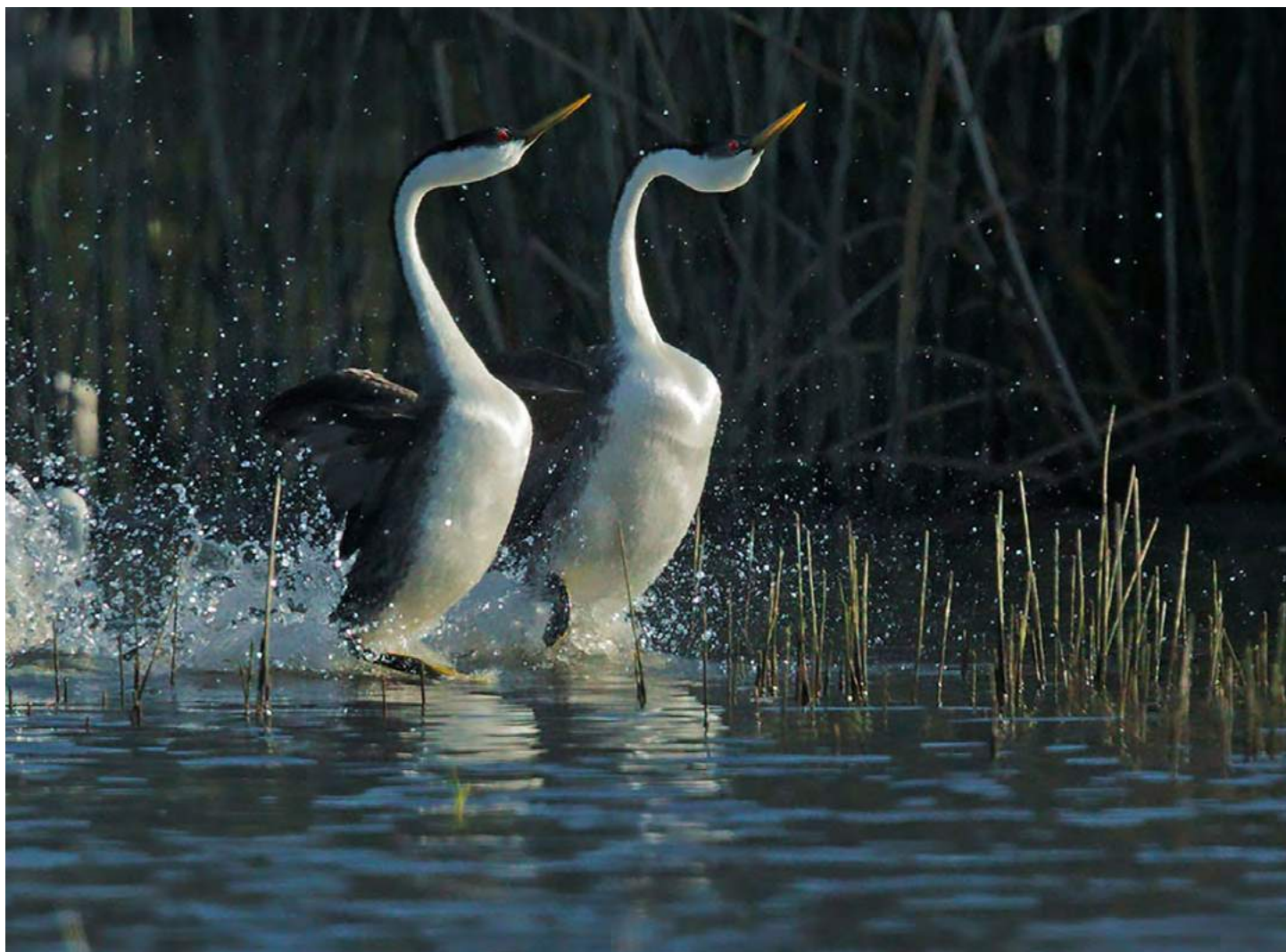

Western grebes performing a courtship dance - Tom Grey

FOCAL SPECIES	KEY PLANNING REGIONS	CONSERVATION RECOMMENDATIONS
Eared grebe	San Joaquin Tulare	Provide nesting habitat in shallow wetlands with emergent or surface vegetation for building floating nests and abundant aquatic invertebrates. Avoid botulism outbreaks by rotating wetlands among areas with no prior evidence of disease. Avoid human disturbance of floating nests (e.g., airboats).
Western grebe	Sacramento San Joaquin Tulare	Provide extensive areas of open, clear water (e.g., reservoirs) with emergent or aquatic vegetation for building floating nests and abundant fish prey. Maintain water levels and establish low-wake zones or enforce closed zones for boats around nesting colonies. Use signage and public outreach to reduce other causes of mortality (e.g., boat propeller strikes, fishing line entanglement). Restore nesting substrates where feasible (Ivey 2004; Robison et al. 2010).
Black rail	Sacramento (and Sierra Nevada foothills)	Provide shallow (<1.2 inch deep) semi-permanent wetlands (particularly those >0.25 acres) with flowing water and dense vegetation. Avoid overgrazing at spring- or stream-fed marshes, especially during the breeding season (March–July). Maintain and improve wetland connectivity (Richmond et al. 2010, 2012).
	Yolo-Delta Suisun	Protect and restore tidally influenced in-stream islands with dense wetland and riparian cover (particularly those >30 acres; Tsao et al. 2015). Maintain or establish upland habitats for escape cover during flood events.
Sandhill crane	Sacramento Yolo-Delta San Joaquin Tulare	Protect vulnerable roost sites by fee-title acquisition or conservation easements; protect foraging landscapes around existing roosts through easements restricting incompatible crop types and development. Enhance food availability (e.g., waste grain) on conservation lands and encourage crane-friendly management on private lands. Develop new protected roost sites toward the edge of crane use areas to enable them to access additional foraging areas (Ivey et al. 2014).
Black tern	Sacramento	Maintain sufficient acreage of rice fields for breeding and foraging. Avoid short-term draw-downs of water during the tern breeding season (May–July).
	San Joaquin	Create tern nesting habitat primarily in years of exceptional runoff, when it will have the greatest impact (Shuford et al. 2001; Shuford 2008). For example, spread water (~ 5 inches deep) over large areas within the Eastside Bypass near Los Banos and the James Bypass/ Fresno Slough south of Mendota Wildlife Area, or draw water from upstream, circulate it through wetland impoundments, and drain it back into the bypass downstream. Maintain a slow but steady flow to reduce botulism risk.
	Tulare	In wet years, flood fields with residual vegetation or crop stubble for use as breeding habitat; retire fields with marginal crop yields and put them in a conservation bank to be flooded when water is available. Avoid botulism outbreaks by rotating wetlands among areas with no prior evidence of disease (Shuford et al. 2001; Shuford 2008).
Forster's tern	San Joaquin Tulare	Provide semi-permanent wetlands and reservoirs with abundant small fish and features attractive for nesting, including barren, isolated islands and clumps of emergent vegetation surrounded by open water. Reduce human disturbance through signage or by closing zones around nesting islands (Shuford 2010, 2014a). In the Tulare planning region, create tern nesting habitat primarily in years of exceptional runoff, as described for the black tern above.
American white pelican	All	Provide large and deep (1–8 ft) semi-permanent wetlands with robust fish populations for foraging during late summer through early winter. Also provide isolated loafing and roosting areas, such as islands and gravel bars (Shuford 2014a).
Least bittern	All	Provide shallow marshes (>25 acres) with dense emergent vegetation, particularly in semi-permanent wetlands already occupied by bitterns. Manage summer wetlands to increase dense emergent vegetation and prevent the spread of invasive plant species (Sterling 2008; Poole et al. 2009).
Snowy egret	All	Restore riparian woodlands for nest colonies near rice fields, wetlands, or flood-irrigated agriculture for foraging. Protect nest colonies from development, human disturbance, and if needed, excessive nest predation (Kelly 2014).
White-faced ibis	Sacramento Yolo-Delta San Joaquin Tulare	Provide shallow marshes with tall, open (early successional) emergent vegetation for nesting. Encourage growers to flood-irrigate (particularly pasture and alfalfa) to provide additional foraging habitat, and promote practices that favor earthworms and other invertebrate prey (e.g., organic). Reduce pesticide use, particularly in wintering areas where currently unregulated (Shuford 2014a).

TABLE 11.5 Conservation recommendations for waterbird focal species, by key planning regions.

LITERATURE CITED

- [CDFW] California Department of Fish and Wildlife. 2016. Special animals list. Available from: <https://nrm.dfg.ca.gov/FileHandler.ashx?DocumentID=109406&inline>
- Chase MK, Geupel GR. 2005. The use of avian focal species for conservation planning in California. In: Bird Conservation Implementation and Integration in the Americas: Proceedings of the Third International Partners in Flight Conference. USDA Forest Service. Gen. Tech. Rep. PSW-GTR-191. p. 130–142. Available from: http://www.fs.fed.us/psw/publications/documents/psw_gtr191/psw_gtr191_0130-0142_chase.pdf
- Dybala KE, Reiter ME, Hickey CM, Shuford WD, Strum KM, Yarris GS. 2017. A bioenergetics approach to setting conservation objectives for non-breeding shorebirds in California's Central Valley. San Franc Estuary Watershed Sci. 15(1):2. Available from: <https://escholarship.org/uc/item/1pd2q7sx>
- Fraye WE, Peters DD, Pywell HR. 1989. Wetlands of the California Central Valley: status and trends: 1939 to mid-1980's. Portland, OR: U.S. Fish and Wildlife Service. Available from: http://www.fws.gov/psw/publications/documents/JFWM-003/suppl_file/012014-jfwm-003.s10.pdf
- Ivey GL. 2004. Conservation assessment and management plan for breeding western and Clark's grebes in California. Unpublished report provided to the American Trader Trustee Council. 80 p. Available from: <https://nrm.dfg.ca.gov/FileHandler.ashx?DocumentID=17796>
- Ivey GL, Herziger CP, Hardt DA. 2014. Conservation priorities and best management practices for wintering Sandhill Cranes in the Central Valley of California. Prepared for The Nature Conservancy of California. International Crane Foundation, Baraboo, Wisconsin.
- Kelly JP. 2014. Snowy Egret (*Egretta thula*). In: Shuford WD, author and editor. Coastal California (BCR 32) Waterbird Conservation Plan: Encompassing the coastal slope and Coast Ranges of central and southern California and the Central Valley. A plan associated with the Waterbird Conservation for the Americas initiative. Sacramento (CA): U.S. Fish and Wildlife Service. p. 89–90. Available from: http://www.centralvalleyjointventure.org/assets/pdf/BCR32_WaterbirdCon_interactive_10FEB14.pdf
- Kushlan JA, Steinkamp MJ, Parsons KC, Capp J, Cruz MA, Coulter M, Davidson I, Dickson L, Edelson N, Elliot R, et al. 2002. Waterbird Conservation for the Americas: The North American Waterbird Conservation Plan. Washington, D.C.: Waterbird Conservation for the Americas. Available from: http://www.waterbirdconservation.org/pdfs/plan_files/complete.pdf
- Poole AF, Lowther P, Gibbs JP, Reid FA, Melvin SM. 2009. Least Bittern (*Ixobrychus exilis*). In: Poole A, editor. The Birds of North America Online. Ithaca (NY): Cornell Lab of Ornithology [Internet]. Available from: <https://birdsna-org.bnaproxy.birds.cornell.edu/Species-Account/bna/species/leabit> & <https://doi.org/10.2173/bna.17>
- Richmond OMW, Chen SK, Risk BB, Tecklin J, Beissinger SR. 2010. California black rails depend on irrigation-fed wetlands in the Sierra Nevada foothills. Calif Agric. 64(2):85–93. doi: 10.3733/cav064n02p85
- Richmond OMW, Tecklin J, Beissinger SR. 2012. Impact of cattle grazing on the occupancy of a cryptic, threatened rail. Ecol Appl. 22(5):1655–1664. doi: 10.1890/11-1021.1
- Robison KM, Weems R, Anderson DW, Gress F. 2010. Western and Clark's grebe conservation and management in California: Annual report, 2009. Davis (CA): California Institute of Environmental Studies. Unpublished report to the American Trader and Kure/Stuyvesant Trustee Councils and National Fish and Wildlife Foundation. 23 p. Available from: <http://nrm.dfg.ca.gov/FileHandler.ashx?DocumentID=45718>
- Shuford WD. 2008. Black Tern (*Chlidonias niger*). In: Shuford WD, Gardali T, editors. California Bird Species of Special Concern: a ranked assessment of species, subspecies, and distinct populations of birds of immediate conservation concern in California. Studies of Western Birds 1. Camarillo (CA): Western Field Ornithologists; and Sacramento (CA): Calif. Dept. Fish and Game. p. 193–198. Available from: <http://www.dfg.ca.gov/wildlife/nongame/ssc/birds.html>
- Shuford WD. 2010. Inland-breeding pelicans, cormorants, gulls, and terns in California: A catalogue, digital atlas, and conservation tool. Nongame Wildlife Program Report 2010-01. Sacramento, CA: California Department of Fish and Game. Available from: <https://nrm.dfg.ca.gov/FileHandler.ashx?DocumentID=24095>
- Shuford WD. 2014a. Coastal California (BCR 32) Waterbird Conservation Plan: Encompassing the coastal slope and Coast Ranges of central and southern California and the Central Valley. Sacramento: U.S. Fish and Wildlife Service. Available from: http://www.centralvalleyjointventure.org/assets/pdf/BCR32_WaterbirdCon_interactive_10FEB14.pdf
- Shuford WD. 2014b. Patterns of distribution and abundance of breeding colonial waterbirds in the interior of California, 2009–2012. Point Blue Conservation Science, Petaluma, California. Available from: www.fws.gov/mountainprairie/species/birds/western_colonial/Colonial_2009-2012_Final_Report_11Nov2014.pdf
- Shuford WD, Dybala KE. 2017. Conservation objectives for wintering and breeding waterbirds in California's Central Valley. San Franc Estuary Watershed Sci. 15(1):4. doi: 10.15447/sfews.2017v15iss1art4
- Shuford WD, Gardali T. 2008. California Bird Species of Special Concern: A ranked assessment of species, subspecies, and distinct populations of birds of immediate conservation concern in California. Western Field Ornithologists, Camarillo, California, and California Department of Fish and Game, Sacramento, California. Available from: <http://www.dfg.ca.gov/wildlife/nongame/ssc/birds.html>
- Shuford WD, Hickey C, Safran R, Page G. 1996. A review of the status of the White-faced Ibis in winter in California. West Birds 27:169–196. Available from: [https://www.westernfieldornithologists.org/archive/V27/27\(4\)p0169-p0196.pdf](https://www.westernfieldornithologists.org/archive/V27/27(4)p0169-p0196.pdf)
- Shuford WD, Humphrey J, Nur N. 2001. Breeding status of the Black Tern in California. West. Birds 32:189–217. Available from: [https://www.westernfieldornithologists.org/archive/V32/32\(4\)p0189-p0217.pdf](https://www.westernfieldornithologists.org/archive/V32/32(4)p0189-p0217.pdf)
- Shuford WD, Sesser KA, Strum KM, Haines DB, Skalos DA. 2016. Numbers of terns breeding inland in California: trends or tribulations? West. Birds 47(3):182–213; doi: 10.21199/WB47.3.1
- Sterling J. 2008. Least Bittern (*Ixobrychus exilis*). In: Shuford WD, Gardali T, editors. California bird species of special concern: a ranked assessment of species, subspecies, and distinct populations of birds of immediate conservation concern in California. Studies of Western Birds 1. Camarillo (CA): Western Field Ornithologists; and Sacramento (CA): Calif. Dept. Fish and Game. p. 136–142. Available from: <http://www.dfg.ca.gov/wildlife/nongame/ssc/birds.html>
- Tsao DC, Melcer Jr RE, Bradbury M. 2015. Distribution and habitat associations of California Black Rail (*Laterallus jamaicensis cortunculcus*) in the Sacramento–San Joaquin Delta. San Franc Estuary Watershed Sci. 13(4):4. doi: 10.15447/sfews.2015v13iss4art4
- [USFWS] U.S. Fish and Wildlife Service. 2008. Birds of Conservation Concern 2008. Arlington, Virginia: U.S. Department of Interior, Fish and Wildlife Service, Division of Migratory Bird Management. Available from: <https://www.fws.gov/migratorybirds/pdf/grants/BirdsofConservationConcern2008.pdf>



1

BREEDING RIPARIAN LANDBIRDS

12



2



3

CHAPTER SUMMARY

Central Valley riparian areas – land alongside rivers and streams – were severely degraded by the end of the 20th century. Partnerships between landowners, non-profits, and government agencies aimed at restoring and protecting riparian areas have seen success, especially in the last decade.

This chapter describes the conservation objectives for riparian habitat restoration and enhancement needed to support self-sustaining, resilient populations of breeding riparian landbirds in the Central Valley. These objectives are based on population and breeding density objectives for a group of 12 focal bird species.

The Conservation Delivery chapter in Section I integrates these habitat objectives with the habitat objectives for other bird groups in the Implementation Plan to present total habitat needs in the Central Valley. The chapter then describes conservation actions for achieving these integrated habitat objectives.

HABITAT TYPE

Riparian habitats are transitional areas between land and water ecosystems, ranging from swift rapids and waterfalls of steep canyons to slow moving water in floodplains. Riparian vegetation is structurally complex and may contain a canopy, subcanopy, and understory layers.



RIPARIAN HABITAT ACREAGE

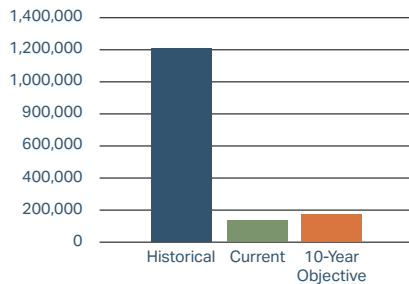

HABITAT SUCCESS STORIES

since the 2006 Implementation Plan

- A total of 8,102 acres of riparian forest has been restored in the Central Valley since the last CVJV update in 2006. This has increased the total riparian habitat in the Central Valley by approximately 20 percent.
- Counting only large-scale riparian restoration efforts, more than 1.8 million trees and shrubs have been planted across the Central Valley since 2006.
- In 2017, the U.S. Congress approved a boundary expansion for the San Joaquin River National Wildlife Refuge. This expanded boundary now encompasses 34 river miles on both sides of California's second largest river, providing a blueprint for river corridor conservation that benefits the birds of the Pacific Flyway as well as fish and terrestrial wildlife.
- A stable population of yellow warblers has recolonized restored agricultural fields along the San Joaquin River. This species was thought to be locally extinct, with the nearest occurrences more than 40 miles away.

SHORT-TERM OBJECTIVE (CURRENT + ADDITIONAL):

173,500 ACRES OF HIGH-QUALITY RIPARIAN HABITAT

WHAT'S NEEDED?

32,000 ADDITIONAL ACRES

BIRD SPECIES INCLUDE:

Representative bird species in Central Valley riparian habitats:

Species of special concern:



Black-headed grosbeak*



Least Bell's vireo***



Common yellowthroat*



Yellow-billed cuckoo****



Spotted towhee**



Bank swallow*****



Ash-throated flycatcher*

* Image: Tom Grey ** Image: Stephen Fettig *** Image: Robert A. Hamilton **** Image: Ed Harper ***** Image: Stephen Fettig

(1) Common yellowthroat - Tom Grey (2) San Joaquin River NWR - River Partners (3) Lazuli bunting - Tom Grey (4) Dos Rios Ranch and San Joaquin River NWR - River Partners

INTRODUCTION

Riparian areas provide important ecosystem services, recreational opportunities, and habitat for wildlife. The Central Valley was once a vast mosaic of native riparian forest, wetlands, and uplands. Historically, riparian habitat was concentrated along the Sacramento and San Joaquin Rivers and their tributaries, as well as the rivers and streams flowing into the Tulare Basin. By the end of the 20th century, over 95 percent of the Central Valley's historical riparian forest had been lost and almost all the major rivers were dammed and are now highly regulated (Katibah 1984). Several riparian landbird species in this region are endangered, threatened, or have some level of special conservation status. This is an indication that the loss of Central Valley riparian forest has severely degraded conditions for wildlife.

Protecting, restoring, and managing Central Valley riparian areas can increase habitat connectivity, restore ecosystem processes, and improve ecosystem function. In turn, this provides wildlife habitat and benefits people in the surrounding communities. These benefits include improving water quality, recharging groundwater, reducing flood risk, supporting pollinators and organisms that help control agricultural pests, providing recreational opportunities, increasing property values, and attracting wildlife watchers and hunters who help support local economies.

In recent decades, government agencies and private organizations have worked together to begin restoring riparian ecosystems by planting riparian vegetation, restoring or mimicking natural hydrology, and reconnecting floodplains and habitat fragments (Golet et al. 2008). These efforts are reflected in several major planning or restoration projects that are underway. For example, the San Joaquin River Restoration Program is returning flows to the river with the goal of restoring naturally-producing and self-sustaining populations of salmon and other fish (Matthews 2007). The recently-adopted 2017 Central Valley Flood Protection Plan Update, developed by the California Department of Water Resources, includes a sophisticated Conservation Strategy that is intended to integrate riparian restoration into projects designed to reduce flood risk to Central Valley communities.

The CVJV has established conservation objectives for riparian habitat restoration, and for population size and breeding density of a representative suite of bird species. This chapter explains these conservation objectives and how they can be applied to reach the conservation goal.

CONSERVATION GOAL

The Central Valley Joint Venture's long-term goal is for Central Valley riparian ecosystems to have sufficient high-quality riparian habitat to support genetically robust, self-sustaining, and resilient bird populations.



(1) Yellow warbler - Tom Grey (2) Riparian habitat at Bobelaine Sanctuary - Brian Gilmore (3) Riparian habitat - Steve Martarano, USFWS

WHICH SPECIES ARE INCLUDED?

The conservation objectives focus on 12 bird species that breed in riparian habitat in the Central Valley and that represent a broad range of life histories and specific habitat needs (Table 12.1). They include species that have or warrant special management status or have experienced population declines or reductions in breeding range in the Valley, and/or species that are useful for monitoring the effects of management actions in Valley riparian ecosystems.

For some species, this is because they are common enough to provide sufficient sample sizes for analyses. Managing riparian habitat to support local populations of this full suite of focal species should, in turn, support diverse and healthy riparian ecosystems (Chase and Geupel 2005).



Nuttall's woodpecker - Tom Grey

SPECIES (SCIENTIFIC NAME)	CONSERVATION STATUS ^a	MIGRATORY STATUS	NEST SUBSTRATE	HABITAT & VEGETATION ASSOCIATIONS
Yellow-billed cuckoo (western distinct population segment) (<i>Coccyzus americanus</i>)	FT, SE, CCV	Migrant	Tree	Large contiguous patches of riparian forest, especially cottonwood-willow
Nuttall's woodpecker (<i>Picoides nuttalli</i>)	--	Resident	Tree, 1° cavity	Mature riparian woodland
Ash-throated flycatcher (<i>Myiarchus cinerascens</i>)	--	Migrant	Tree, 2° cavity	Mature, open riparian woodland
Least Bell's vireo (<i>Vireo bellii pusillus</i>)	FE, SE, CCV	Migrant	Shrub	Dense, shrubby early- to mid-successional riparian
Bank swallow (<i>Riparia riparia</i>)	ST	Migrant	Burrow	Cut banks, dependent on meander migration, colonial breeder
Spotted towhee (<i>Pipilo maculatus</i>)	--	Resident	Ground	Dense understory and ground cover
Song sparrow (<i>Melospiza melodia</i>)	BSSC ^b , CCV ^b	Resident	Herb, Shrub	Dense understory
Yellow-breasted chat (<i>Icteria virens</i>)	BSSC	Migrant	Shrub	Dense, shrubby riparian thickets
Common yellowthroat (<i>Geothlypis trichas</i>)	--	Migrant	Herb, Shrub	Dense understory and ground cover, especially near river edges and wetlands
Yellow warbler (<i>Setophaga petechia</i>)	BSSC	Migrant	Shrub	Riparian thickets, especially willows
Black-headed grosbeak (<i>Pheucticus melanocephalus</i>)	--	Migrant	Tree	Complex habitat with large trees and dense understory
Lazuli bunting (<i>Passerina amoena</i>)	--	Migrant	Herb, Shrub	Open scrubby and early-successional riparian, edges

^a Conservation status designations: FE, FT, federally endangered or threatened species; SE, ST, state endangered or threatened species; BSSC, state bird species of special concern; and CCV, species ranked among the most vulnerable to climate change (Gardali et al. 2012).

^b In the Central Valley, only the Suisun and Modesto subspecies are considered species of special concern or ranked as climate change vulnerable.

TABLE 12.1 Riparian focal species: Conservation status and habitat associations during the breeding season.

WHICH GEOGRAPHIC AREAS ARE INCLUDED?

Conservation objectives were defined for four of the five planning regions in the CVJV's Primary Focus Area, excluding Suisun: Sacramento, Yolo-Delta, San Joaquin, and Tulare (Figure 12.1). Suisun was excluded for its lack of freshwater riparian habitat.

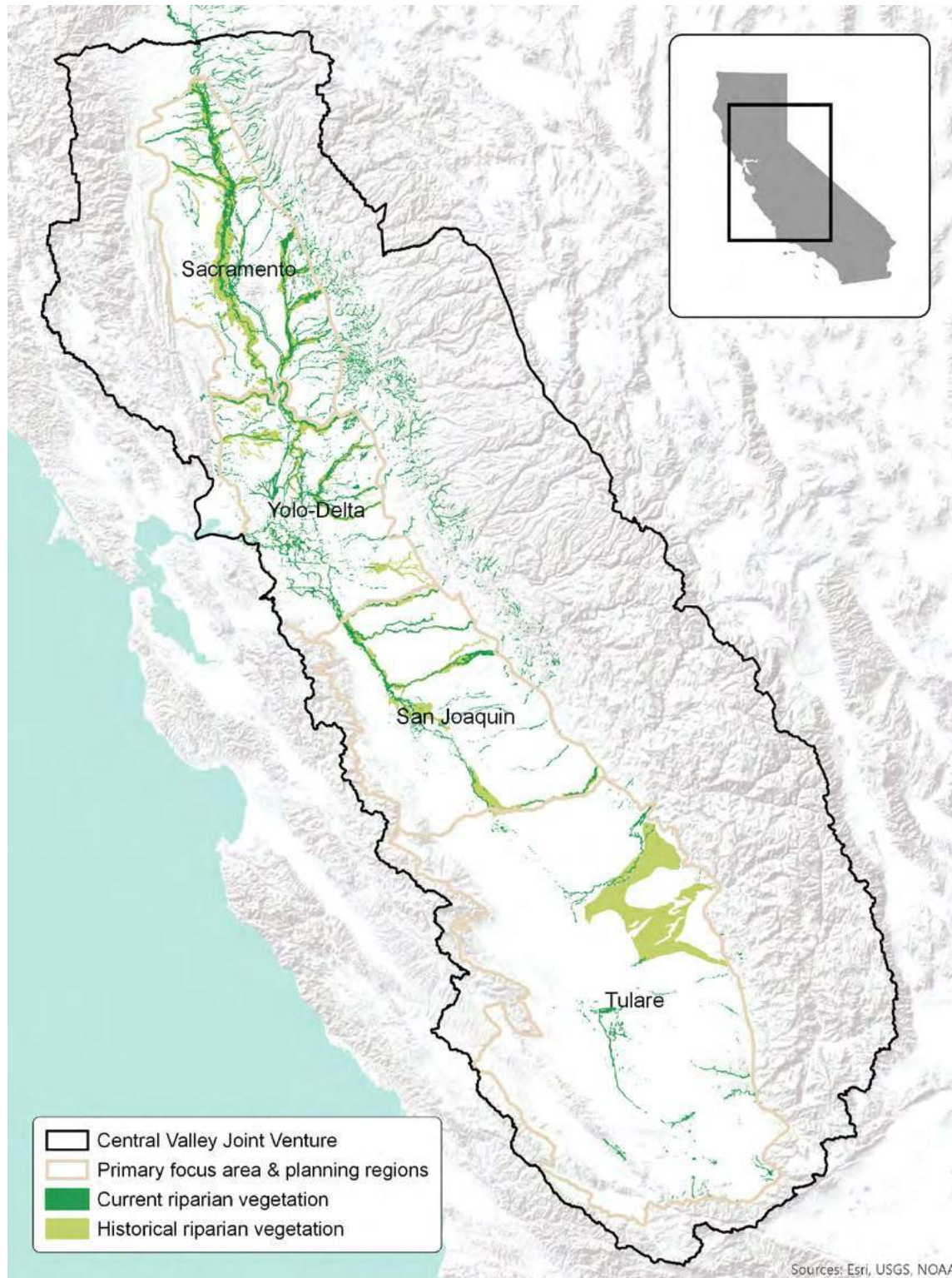

FIGURE 12.1 Central Valley Joint Venture perimeter and Primary Focus Area, divided into planning regions. Also shown are estimated areas of historical (pre-1900) and current riparian vegetation.

CURRENT CONDITIONS

Current Population Sizes and Trends

Survey data collected between 2008 and 2014 were used to estimate current Valley breeding population sizes of the focal bird species. These population sizes range from very small (<1,000 individuals) to large (>100,000 individuals) (Figure 12.2). More than half of the populations are currently small (<10,000 individuals) or very small (<1,000 individuals) and may be at risk of extirpation. Least Bell's vireo is largely extirpated in the Central Valley so population sizes are assumed to be near zero. Yellow-breasted chat and black-headed grosbeak both exhibit significant, long-term declining trends in the Coastal California Bird Conservation Region (BCR 32), which encompasses the Central Valley, and both bank swallow and yellow-billed cuckoo populations are estimated to have steeply declining trends with an average decline of more than 30 percent every 10 years. The cuckoo's population size is small and the trend estimates are uncertain. In addition, only five of the 12 focal species are currently considered resilient, meaning they have viable or large populations in at least two planning regions.

Current Habitat

Historically, the CVJV's Primary Focus Area contained more than 1.2 million acres of riparian habitat (and possibly much more; estimates of historical habitat acreage vary widely). In contrast, today only an estimated total of 141,600 acres of riparian vegetation exists in this area, of which nearly half is within the Sacramento planning region (Figure 12.1 and Table 12.2). Data from 2012 California Department of Fish and Wildlife (CDFW) riparian vegetation GIS layers (references in Dybala et al. 2017b) were used to estimate the current extent of riparian vegetation.

As a further indicator of current habitat conditions, the findings that over half of the regional focal species' populations are currently small or very small, that two species have steeply declining population trends, and that fewer than half of the focal species are considered resilient, suggest significant habitat loss and degradation. These findings indicate there is considerable room for improvement in Central Valley riparian ecosystems.

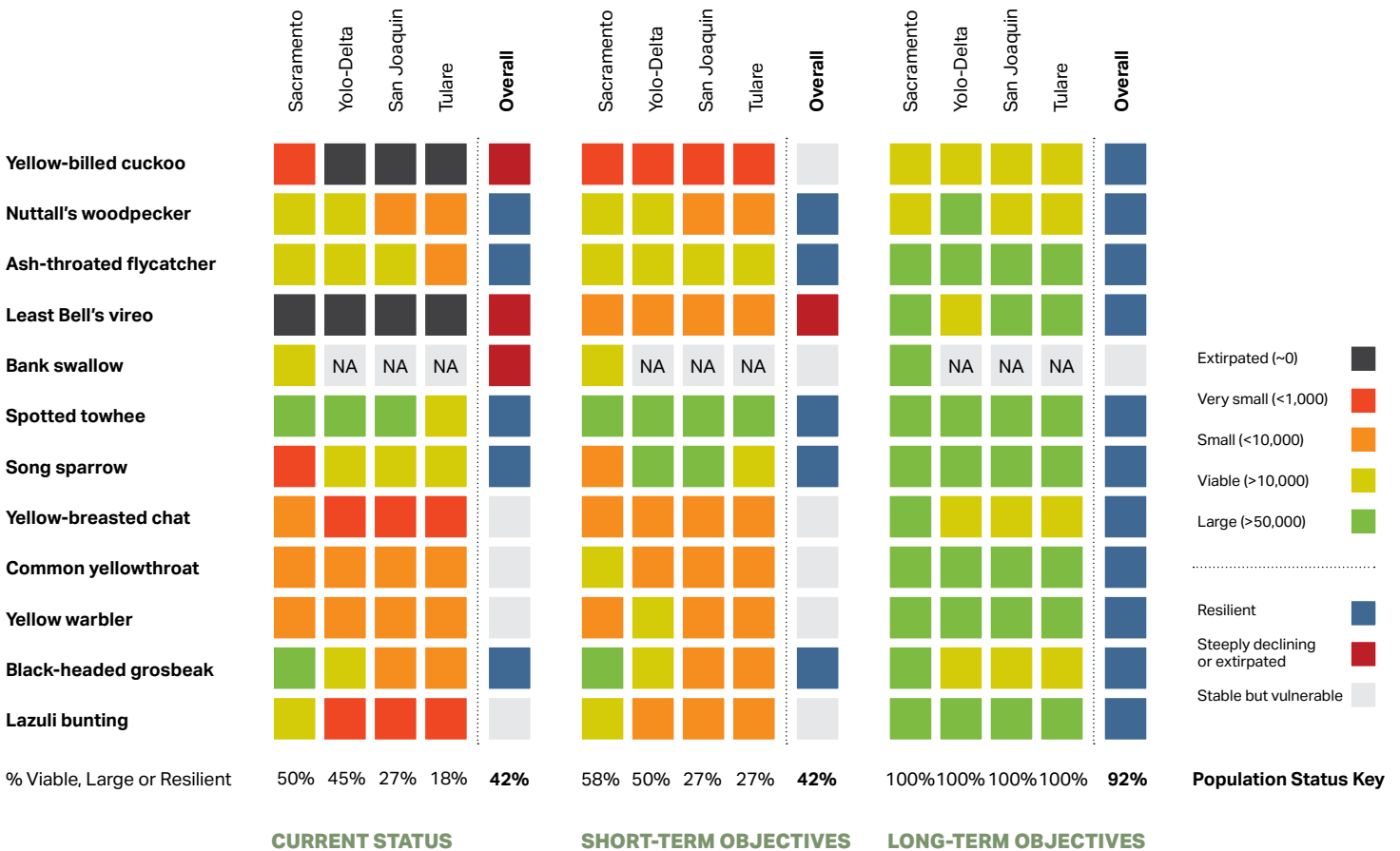

(NA: Not applicable)

FIGURE 11.2 Population status and objectives for Central Valley focal riparian bird species.

DEVELOPING THE CONSERVATION OBJECTIVES



Bank swallows - Tom Grey

Population Objectives

To develop the long-term population objectives for each focal species in each of the study's planning regions, the first step was to develop a population status framework based on general principles of conservation and population biology (Dybala et al. 2017a). The framework is structured as a hierarchy of four population size categories that mark milestones in becoming a genetically robust, self-sustaining, ecologically functional, and resilient population. The categories are: very small (<1,000), small (<10,000), viable (>10,000), and large (>50,000). Two additional modifiers describe steeply declining populations (>30 percent decline over 10 years), which are at high risk of extirpation regardless of population size, and resilient populations, which should be more capable of recovering from an environmental catastrophe in one part of the range if they have more than one self-sustaining sub-population.

The population status framework was used to define long-term (100-year) population objectives for each focal species in each planning region. The objectives are for each species to be stable or increasing, at least viable (>10,000 individuals), preferably large (>50,000 individuals), and resilient (more than one viable or large regional population). Special status species are treated slightly differently. For bank swallow, this Implementation Plan simply adopts the population objec-

tive defined in the existing bank swallow conservation strategy: 50,000 (equivalent to large) for the Sacramento region (BANS-TAC 2013), the only region of the Valley with evidence of current colony occupation. Because yellow-billed cuckoo does not yet have a recovery plan with already defined population objectives, this Plan defines a preliminary population objective of viable (>10,000 individuals) for all four planning regions. Least Bell's vireo does have a draft recovery plan (USFWS 1998), but it does not define specific numerical population objectives, so this Plan treats it like any other focal species.

Breeding Density and Habitat Objectives

Because so much historical riparian habitat in the Central Valley has been lost and degraded, it is likely that many of the focal species' regional populations are currently limited by available habitat and that the current breeding densities of many of the focal species may be unusually low due to reduced habitat quality. Therefore, meeting the population objectives would require both habitat restoration and enhancement efforts to increase both the total area of habitat available to species and their average breeding densities. The Plan defines long-term habitat and breeding density objectives such that achieving both would result in meeting the long-term population objectives.

Excluding bank swallow and yellow-billed cuckoo (which were treated separately), potential breeding densities were determined by examining density estimates reported for Breeding Bird Census (BBC) plots in riparian vegetation in the western United States (1988-2009; Gardali and Lowe 2006). In many cases, current Central Valley breeding densities are far lower than BBC densities. The Plan defines long-term density objectives for each species

in each planning region as the 75th percentile of the observed BBC densities, unless the species' current regional density already exceeded this objective. In that case, the objective is to maintain the current density.

The next step was to calculate the minimum area of riparian habitat in each planning region that would be required to reach specified benchmarks. The benchmarks include: All 10 remaining focal species reach the threshold for a viable population (>10,000 individuals) in each planning region; 7 of the 10 focal species reach the threshold for a large population (>50,000 individuals) in each planning region; and each focal species has at least one large regional population.

To track progress during the lifespan of this Plan, short-term (10-year) habitat objectives were established that represent one-tenth of the long-term objectives.

Density objectives for bank swallow were not defined because an average density per unit area of riparian vegetation is less applicable to a colonial-nesting species. These species are expected to respond more to the availability of suitable nesting sites than to the addition of riparian vegetation acres. Yellow-billed cuckoo was also treated differently because breeding densities for this species are highly variable and difficult to estimate (Hughes 2015). Instead, the cuckoo's regional breeding density objective was calculated as the average density required to reach a population size of viable in each region, assuming the long-term habitat objectives were met. These density objectives are well within the range of observed cuckoo breeding densities in other regions.

Additional details on the sources of data, methods, results, and references can be found in Dybala et al. (2017b).

CONSERVATION OBJECTIVES

Habitat

The Plan defines short-term (10-year) and long-term (100-year) habitat objectives for riparian vegetation in each of the four planning regions (Table 12.2). These habitat objectives represent the estimated total extent of riparian vegetation required to meet the population objectives for all 12 focal species in each planning region. In total, the long-term objectives represent 36 percent of the estimated historical extent of riparian vegetation in the Central Valley.

PLANNING REGION	LONG-TERM HABITAT OBJECTIVE	CURRENT ESTIMATE	ACRES NEEDED (DIFFERENCE)	ACRES NEEDED BY 2030 (10%)
Riparian Vegetation				
Sacramento	151,671	67,897	83,774	8,377
Yolo-Delta	91,925	32,869	59,056	5,906
San Joaquin	108,626	24,949	83,677	8,368
Tulare	108,626	15,893	92,733	9,273
Total	460,849	141,608	319,241	31,924

TABLE 12.2 Short-term (10-year) and long-term (100-year) habitat objectives for breeding riparian birds. Objectives (in acres) are shown by planning region along with current estimates of existing habitat and the estimated additional acres needed to meet the habitat objectives. (Sums may not be exact, due to rounding in original data.)

Population

The Plan defines long-term (100-year) population objectives of >10,000 or >50,000 individuals for each of the focal species in each planning region (Figure 12.2). These population objectives represent the estimated population sizes needed to reach the goal of genetically robust, self-sustaining, resilient populations.

SPECIES	SACRAMENTO	YOLO-DELTA	SAN JOAQUIN	TULARE
Yellow-billed cuckoo	0.066	0.109	0.092	0.092
Nuttall's woodpecker	*0.274	*0.544	0.227	0.227
Ash-throated flycatcher	*0.498	*0.866	*0.460	0.460
Least Bell's vireo	0.497	0.497	0.497	0.497
Bank swallow	--	--	--	--
Spotted towhee	*2.134	*2.166	*2.334	2.334
Song sparrow	1.213	*1.349	*1.755	1.755
Yellow-breasted chat	0.330	0.330	0.330	0.330
Common yellowthroat	0.606	0.606	0.606	0.606
Yellow warbler	0.557	0.557	0.557	0.557
Black-headed grosbeak	*0.881	0.382	0.382	0.382
Lazuli bunting	0.611	0.611	0.611	0.611

*No density objectives were set for bank swallow, and density objectives for the Tulare region were set equal to objectives for the adjacent San Joaquin region. * Density objective is to maintain current average density.*

TABLE 12.3 Long-term (100-year) average breeding density objectives for each riparian focal species in each planning region.

Breeding Density

The Plan defines long-term (100-year) average breeding density objectives for each focal species in each planning region (Table 12.3). These density objectives represent the estimated average breeding densities that could be reached with improvements in both the quality and quantity of riparian ecosystems in each planning region.



APPLYING THE CONSERVATION OBJECTIVES

Applying the Breeding Density Objectives

The breeding density objectives can be used in several ways. At habitat restoration sites, they can be used to demonstrate that the restoration activities are creating quality habitat in which the focal species are ultimately able to meet or exceed the density objectives. Similarly, in existing habitat, they can be used to demonstrate the effectiveness of habitat enhancement activities in which the focal species' breeding densities improve and ultimately meet or exceed the density objectives. Finally, they can be used as part of a project planning process to project the potential number of individuals of each focal species that a restoration or enhancement project site may be able to support. Progress toward the breeding density objectives can be tracked through regular surveys of riparian breeding birds at project sites, and overall by surveying throughout each planning region.

By improving species densities, fewer acres of habitat are required to meet the population objectives, and in turn the conservation goals. Therefore, the CVJV encourages efforts to improve conditions in existing riparian vegetation. Such habitat enhancement efforts might include removing invasive plant species or increasing diversity in the composition and structure of riparian vegetation.

Applying the Habitat Objectives

The habitat objectives represent estimates of the total area of riparian habitat required to enable focal species' Central Valley populations to reach the long-term population objectives, and therefore the total area required to reach the Plan's long-term conservation goal. Subtracting the estimated current amount of riparian vegetation from the long-term objective provides the estimated additional acres needed in each region (Table 12.2), assuming none of the current extent is lost.

To track progress within this Plan's timeline, short-term (10-year) habitat objectives for each region were set at one-tenth of the long-term additional acreage needed. These additional acres can be achieved through habitat restoration.

For the purposes of this chapter, "habitat restoration" means conversion of land that is not currently covered by the target land cover type into the target land cover type. For riparian habitat, this includes establishing new areas with native riparian-associated shrubs and trees (based upon the 2012 riparian vegetation GIS layer).

The acreage of new riparian vegetation created by a restoration project in one of the planning regions would count as contributing to these habitat objectives. Overall progress toward the riparian vegetation objectives can be tracked through updates to CDFW vegetation GIS layers (<https://www.wildlife.ca.gov/Data/BIOS/Dataset-Index>).

"Habitat enhancement," in this situation, indicates managing existing riparian vegetation to improve habitat quality. The acreage of enhanced riparian vegetation should not be counted toward the habitat objectives. Instead, habitat enhancement should be measured using the breeding density objectives as described previously.

The habitat objectives can be used to measure the contribution of an individual project to the CVJV goals. They can also be used to guide other planning processes with respect to the magnitude of restoration that is needed within each region.

(1-4) Habitat restoration at San Joaquin NWR Hageman Unit - River Partners



SUCCESS STORY



LEAST BELL'S VIREO REAPPEARS IN THE CENTRAL VALLEY

The 2005 discovery of least Bell's vireo, a species previously thought extinct in the Central Valley, heralded a huge success in efforts to restore riparian bird habitat in the San Joaquin Valley. The birds were found on the San Joaquin River National Wildlife Refuge, in a tree planted by River Partners (a CVJV partner) two years earlier. Engaged since 2002 in the largest contiguous riparian restoration project in California, CVJV partners have detected least Bell's vireo in five additional years in forests planted on the refuge.



River Partners adapts restoration methods in response to feedback from CVJV partners. As a result, 1- to 2-year-old restoration sites in the most recent phase of the project achieved breeding densities equivalent to 3- to 6-year-old densities in the first phase for six CVJV riparian focal species. River Partners is now achieving the CVJV breeding density objective for song sparrows within two years of completing restoration.

River Partners' restoration efforts – based on recommendations from the California Partners in Flight Riparian Bird Conservation Plan – will protect and restore more than 5,000 acres within the San Joaquin River NWR and adjacent private lands, including the Dos Rios Ranch. Over the past 10 years, the project has attracted more than \$50 million for the permanent protection of 2,285 acres, including restoration of 600 acres.



(1) Least Bell's vireo - Robert A. Hamilton (2) & (3) Vireo habitat restoration at San Joaquin River NWR Hageman Unit - River Partners

ADDITIONAL CONSERVATION CONSIDERATIONS

Adapt habitat restoration to extreme weather events

The CVJV recommends anticipating extreme weather events, like drought and flood, when developing plans and designing riparian restoration (Gardali et al. In prep.; Perry et al. 2015). For example, consider whether current designs use plant species and varieties that will continue to thrive under projected climate conditions, including changes in temperature and precipitation, more extreme weather patterns, and changes in hydrology and groundwater availability. The long-term success of current riparian restoration efforts will depend on whether species being planted now will survive for decades. Incorporating shifting climate patterns into restoration planning should become as standard as the typical attention paid to soils and hydrology (Griggs 2008).

Plan for species-specific habitat needs

In addition to a general strategy of restoring and enhancing riparian vegetation, individual species have habitat needs that will require attention to patch size, location, and vegetation structure. For example, the yellow-billed cuckoo requires large, contiguous patches of riparian vegetation (Gaines 1974). Restoration efforts must therefore strategically locate habitat to maximize continuous, uninterrupted areas of riparian vegetation. Nesting least Bell's vireos use a well-developed and layered canopy, with highest foliage density within one to two meters of the ground (Kus 1998), thus requiring restoration efforts to pay specific attention to vegetation structure.

Restore hydrological processes

Specific attention should be given to promoting natural river processes where it is feasible. These efforts could include removing river bank revetment,

using set-back levees and conservation easements to protect river meander, and adopting flow regimes that maintain and improve river processes. For example, bank swallows depend on suitable nesting sites in cut banks created by river flows. Similarly, the least Bell's vireo, yellow-breasted chat, and lazuli bunting are all associated with scrubby, early- to mid-successional riparian vegetation, and seasonal flooding would help provide the disturbance that generates the early-successional vegetation used by these species. In addition, promoting natural river processes may improve the conditions for further riparian restoration and management through sediment deposition, groundwater recharge, and seed dispersal (Florsheim and Mount 2003; Opperman 2012), ultimately benefiting many riparian species. Integrating the habitat needs of riparian wildlife with recovery efforts for Central Valley fishes, including salmon, is an exciting opportunity.

Inhibit brown-headed cowbirds

Recommendations for minimizing the risk of cowbird parasitism are well-established and include managing for a dense shrub layer, managing grazing and mowing near riparian areas, and minimizing the availability of nearby cowbird food sources, such as those provided by dairies and feedlots (Dybala et al. 2014). The most common recommendation for minimizing cowbird risk is simply to restore habitat. Specifically, improve the continuity of large tracts of high-quality habitat, widen narrow corridors, and minimize edges, all of which may have the added benefit of reducing access by many nest predators (Dybala et al. 2014).

Consider benefits to waterbirds

In addition to providing habitat for riparian landbirds, riparian vegetation also provides roosting and nesting habitat for some waterbirds (see Breeding and Non-Breeding Waterbirds chapter). For these waterbirds, the amount of riparian vegetation is not as important as the location of this habitat near suitable foraging habitat, such as managed wetlands and postharvest-flooded crops. Riparian vegetation that is strategically located adjacent to waterbird foraging habitat will contribute to the habitat objectives for both breeding riparian landbirds and some waterbirds.



(1) Least Bell's vireo nest - Julie Rentner (2) Yellow-breasted chat - Tom Grey

LITERATURE CITED

[BANS-TAC] Bank Swallow Technical Advisory Committee. 2013. Bank Swallow (*Riparia riparia*) conservation strategy for the Sacramento River watershed, California. Version 1.0. Available from: www.sacramentoriver.org/bans

Chase MK, Geupel GR. 2005. The use of avian focal species for conservation planning in California. In: Bird Conservation Implementation and Integration in the Americas: Proceedings of the Third International Partners in Flight Conference. USDA Forest Service. Gen Tech Rep PSW-GTR-191. p. 130–142. Available from: http://www.fs.fed.us/psw/publications/documents/psw_gtr191/psw_gtr191_0130-0142_chase.pdf

Dybala KE, Clipperton N, Gardali T, Golet GH, Kelsey R, Lorenzato S, Melcer Jr. R, Seavy NE, Silveira JG, Yarris GS. 2017a. A General Framework for Setting Quantitative Population Objectives for Wildlife Conservation. *San Franc Estuary Watershed Sci.* 15(1): Article 8.

Dybala KE, Clipperton N, Gardali T, Golet GH, Kelsey R, Lorenzato S, Melcer Jr. R, Seavy NE, Silveira JG, Yarris GS. 2017b. Population and habitat objectives for avian conservation in California's Central Valley riparian ecosystems. *San Franc Estuary Watershed Sci.* 15(1): Article 5.

Dybala KE, Seavy NE, Dettling MD, Gilbert MM, Melcer R. 2014. Does restored riparian habitat create ecological traps for riparian birds through increased Brown-headed Cowbird nest parasitism? *Ecol Restor.* 32:239–248. doi: <http://dx.doi.org/10.3368/er.32.3.239>

Florsheim JL, Mount JF. 2003. Changes in lowland floodplain sedimentation processes: pre-disturbance to post-rehabilitation, Cosumnes River, CA. *Geomorphology* 56:305–323. doi: [http://dx.doi.org/10.1016/S0169-555X\(03\)00158-2](http://dx.doi.org/10.1016/S0169-555X(03)00158-2)

Gaines DA. 1974. Review of the status of the Yellow-Billed Cuckoo in California: Sacramento Valley populations. *Condor* 76:204–209. doi: <http://dx.doi.org/10.2307/1366731>

Gardali T, Campos B, Dybala K, Parodi J, Seavy N, Thalmayer I. In prep. A framework for making ecological restoration climate-smart. *Point Blue Conservation Science*, Petaluma, CA.

Gardali T, Lowe JD. 2006. Reviving resident bird counts: the 2001 and 2002 breeding bird census. *Bird Popul.* 7:90–95. Available from: http://birdpop.org/docs/journals/Volume-7/BPJ07-11_Gardali_and_Lowe_Census2001.pdf

Gardali T, Seavy NE, DiGaudio RT, Comrack LA. 2012. A climate change vulnerability assessment of California's at-risk birds. *PLoS One* 7:e29507. doi: <http://dx.doi.org/10.1371/journal.pone.0029507>

Golet GH, Gardali T, Howell CA, Hunt J, Luster RA, Rainey W, Roberts MD, Silveira JG, Swagerty H, Williams N. 2008. Wildlife response to riparian restoration on the Sacramento River. *San Franc Estuary Watershed Sci.* 6(2):1. doi: <http://dx.doi.org/10.5811/westjem.2011.5.6700>

Griggs FT. 2008. California riparian habitat restoration handbook. River Partners. Available from: http://riverpartners.org/documents/Restoration_Handbook_Final_Dec09.pdf

Hughes JM. 2015. Yellow-billed Cuckoo (*Coccyzus americanus*). Poole A, editor. Ithaca, NY: Cornell Lab of Ornithology. Available from: <http://bna.birds.cornell.edu/bna/species/418>

Katibah EF. 1984. A brief history of riparian forests in the Central Valley of California. In: Warner RE, Hendrix KM, editors. *California Riparian Systems: Ecology, Conservation, and Productive Management*. Berkeley: University of California Press. p. 24–30. Available from: <http://ark.cdlib.org/ark:/13030/ft1c6003wp/>

Kus BE. 1998. Use of restored riparian habitat by the endangered Least Bell's Vireo (*Vireo bellii pusillus*). *Restor Ecol.* 6:75–82. doi: <http://dx.doi.org/10.1046/j.1526-100x.1998.06110.x>

Matthews N. 2007. Rewatering the San Joaquin River: A Summary of the Friant Dam Litigation. *Ecol Law Q.* 34. doi: <http://dx.doi.org/10.15779/Z38WV7C>



Yellow-billed cuckoo - Mark Dettling

Opperman JJ. 2012. A conceptual model for floodplains in the Sacramento-San Joaquin Delta. *San Franc Estuary Watershed Sci.* 10(3). Available from: <http://escholarship.org/uc/item/2kj52593>

Perry LG, Reynolds LV, Beechie TJ, Collins MJ, Shafroth PB. 2015. Incorporating climate change projections into riparian restoration planning and design. *Ecology* 8:863–879. doi: <http://dx.doi.org/10.1002/eco.1645>

[USFWS] U.S. Fish and Wildlife Service. 1998. Draft Recovery Plan for the least Bell's vireo (*Vireo bellii pusillus*). Portland, OR: U.S. Fish and Wildlife Service. Available from: https://ecos.fws.gov/tess_public/profile/speciesProfile.action?sPCODE=B067



BREEDING GRASSLAND - OAK SAVANNAH LANDBIRDS



CHAPTER SUMMARY

The landscape of the Central Valley includes grassland and oak savannah ecosystems that are important both to native wildlife and to the people living in this region. These upland ecosystems form a ring of open country, foothills and rangelands surrounding the valley floor. Though more than half of historical grassland and oak savannah acreage has been lost, the remaining habitat supports a thriving community of native landbirds.

This chapter describes the conservation objectives for enhancing existing grassland and oak savannah lands and restoring additional acreage of these habitat types. The goal is to support resilient populations of Central Valley upland bird species.

The Conservation Delivery chapter in Section I integrates these habitat objectives with the habitat objectives for other bird groups in the Implementation Plan to present total habitat needs in the Central Valley. The chapter then describes conservation actions for achieving these integrated habitat objectives.

HABITAT TYPE

Grasslands in the Central Valley are landscapes dominated by grasses and other herbaceous plant species with less than 10 percent tree canopy cover. Oak savannahs are woodlands with sparse (10 percent to 40 percent) canopy cover, with oaks (*Quercus* spp.) as the dominant tree species and primarily grass-dominated understories.



BREEDING DENSITY OBJECTIVES:

Three actions are needed to reach the breeding density objectives:

- Enhance existing habitat to increase breeding density of focal species. Goal: reach viable (>10,000) or large (>50,000) populations, depending on the species.
- Restore additional acres of habitat.
- Protect existing habitat from development.

GRASSLAND AND OAK SAVANNAH HABITAT: A New Focus

Grassland and oak savannah ecosystems in the Central Valley provide multiple economic and social benefits, ecosystem services, and vital bird habitat. There is a growing interest in protecting, restoring, and managing these ecosystems, and the Central Valley Joint Venture provides leadership in the formulation of conservation goals and objectives.

SHORT TERM HABITAT OBJECTIVES: WHAT'S NEEDED?"

10,300 ADDITIONAL ACRES OF HIGH-QUALITY GRASSLAND HABITAT

8,500 ADDITIONAL ACRES OF HIGH-QUALITY OAK SAVANNAH HABITAT

BIRD SPECIES INCLUDE:

Representative bird species of the Central Valley's grassland-oak savannah:

Species of heightened conservation concern:



Western meadowlark*



Burrowing owl***



Western bluebird**



Grasshopper sparrow***



Acorn woodpecker**



Loggerhead shrike***



American kestrel***



Yellow-billed magpie**

* Stephen Fettig ** Brian Gilmore *** Tom Grey

(1) Western bluebirds - Tom Grey (2) Native perennial grasslands, Llano Seco Ranch - Joe Silveira (3) Yellow-billed magpie - Brian Gilmore (4) Mixed grassland-oak savannah habitat, South Fork American River - Mark Leder Adams

INTRODUCTION

Grassland and oak savannah ecosystems are an important component of Central Valley uplands, particularly the ring of open country, low-elevation (<3,000 feet) foothills and rangelands surrounding the valley floor (Figure 13.1). Roughly 60 percent of the Central Valley's historic grasslands have been lost due to conversion to intensive agriculture and urban development (CPIF 2000; DGP-GIC 2003). Comparable historical data on the extent of oak savannah ecosystems in the Central Valley are lacking, but the magnitude of loss is believed to be similar, based on the reported loss of rangeland habitat in the state (which by definition includes oak savannah; Cameron et al. 2014). Today, grasslands and oak savannahs are still at risk of conversion to land uses that do not provide the suite of ecosystem services that these land types currently generate (Cameron et al. 2014; Byrd et al. 2015).

These ecosystems are critically important to landbirds. Across North America, grassland-associated birds have declined by as much as 40 percent since 1968 (NABCI 2014). In California, several landbird species associated with grassland and oak savannah have declined in abundance and are now considered Species of Special Concern (Shuford and Gardali 2008).

Ensuring that these species do not become threatened or endangered in the future will help to minimize regulatory oversight on private landowners. Furthermore, a number of other conservation targets overlap with these ecosystems, including the many special status species associated with vernal pools and the habitat for the Central Valley population of California tiger salamanders (*Ambystoma californiense*).

In addition to providing important habitat for landbirds and other wildlife, these ecosystems provide a number of important functions, including providing nutrient and water cycling, sequestering carbon, supporting pollinator populations, and producing food and fiber for people through livestock operations (Havstad et al. 2007; Kroeger et al. 2009; Chaplin-Kramer et al. 2011).

CONSERVATION GOAL

The Central Valley Joint Venture's long-term goal is for Central Valley grassland and oak savannah ecosystems to have sufficient high-quality habitat to support genetically robust, self-sustaining, and resilient native bird populations.



Vernal pool, Llano Seco Ranch - Joe Silveira

WHICH SPECIES ARE INCLUDED?

The conservation objectives focus on 12 bird species that breed in grassland and oak savannah ecosystems and that represent a broad range of life histories and a continuum of specific habitat needs (Table 13.1).

The focal species are divided into two major groups: five species that principally use grassland vegetation and seven that principally use oak savannah vegetation. Managing habitat to support local populations of the full suite of focal species should in turn support diverse and healthy grassland and oak savannah ecosystems (Chase and Geupel 2005).



Western kingbird - Stephen Fetting

SPECIES (SCIENTIFIC NAME)	CONSERVATION STATUS ^a	MIGRATORY STATUS	NEST SUBSTRATE	HABITAT & VEGETATION ASSOCIATIONS
GRASSLAND				
Northern harrier (<i>Circus cyaneus</i>)	BSSC	Resident/ migrant	Ground/ shrub	Forages over a variety of open landscapes but prefers to nest in shrubby or weedy fields
Burrowing owl (<i>Athene cunicularia</i>)	BSSC	Resident/ migrant	Burrow	Open, low stature grassland, and/or a significant amount of bare ground
Horned lark (<i>Eremophila alpestris</i>)	CBSD	Resident/ migrant	Ground	Open, low stature grassland, and/or a significant amount of bare ground
Grasshopper sparrow (<i>Ammodramus savannarum</i>)	BSSC, CBSD	Migrant	Ground	Grassland; tolerant of some shrub cover; may favor sloped landscapes rather than flat areas
Western meadowlark (<i>Sturnella neglecta</i>)	--	Resident	Ground	Grassland, though will use trees for singing perches
OAK SAVANNAH				
Acorn woodpecker (<i>Melanerpes formicivorus</i>)	--	Resident	Tree, 1° cavity	Oak savannah and oak woodland
American kestrel (<i>Falco sparverius</i>)	--	Resident	Tree, 2° cavity	Dense understory oak savannah and grassland
Western kingbird (<i>Tyrannus verticalis</i>)	--	Migrant	Tree	Oak savannah
Loggerhead shrike (<i>Lanius ludovicianus</i>)	BSSC, CBSD	Resident	Shrub/ tree	Grassland, oak savannah, and open shrubland; less frequently riparian and oak woodland
Yellow-billed magpie (<i>Pica nuttalli</i>)	CCV, UCC, NT	Resident	Tree	Oak savannah, woodland, and riparian edge
Western bluebird (<i>Sialia mexicana</i>)	--	Resident	Tree, 2° cavity	Oak savannah and woodland, nests in tree cavities but often forages in open areas and grassland edge
Lark sparrow (<i>Chondestes grammacus</i>)	--	Resident/ migrant	Ground	Oak savannah and grassland/woodland ecotones; requires trees for foraging and singing

^a Conservation status designations: BSSC, state bird species of special concern (Shuford and Gardali 2008); CCV, species ranked among the most vulnerable to climate change (Gardali et al. 2012); CBSD, common birds in steep decline (PIF 2012); UCC, U.S.-Canada species of conservation concern (PIF 2012); and NT, near threatened (BirdLife International 2014)

TABLE 13.1 Breeding grassland and oak savannah focal species: Conservation status, life history traits, and habitat/vegetation associations. Species are listed under their principal breeding habitats.

WHICH GEOGRAPHIC AREAS ARE INCLUDED?

The conservation objectives encompass the CVJV's Primary Focus Area (the valley floor) and the Secondary Focus Area (the surrounding foothills; Figure 13.1). Because mountain meadows are ecologically distinct and should be treated separately from valley and foothill grasslands, the conservation objectives only address grassland and oak savannah in the Secondary Focus Area up to a maximum elevation of 3,000 feet. This is the first time the CVJV has defined conservation objectives for the Secondary Focus Area.

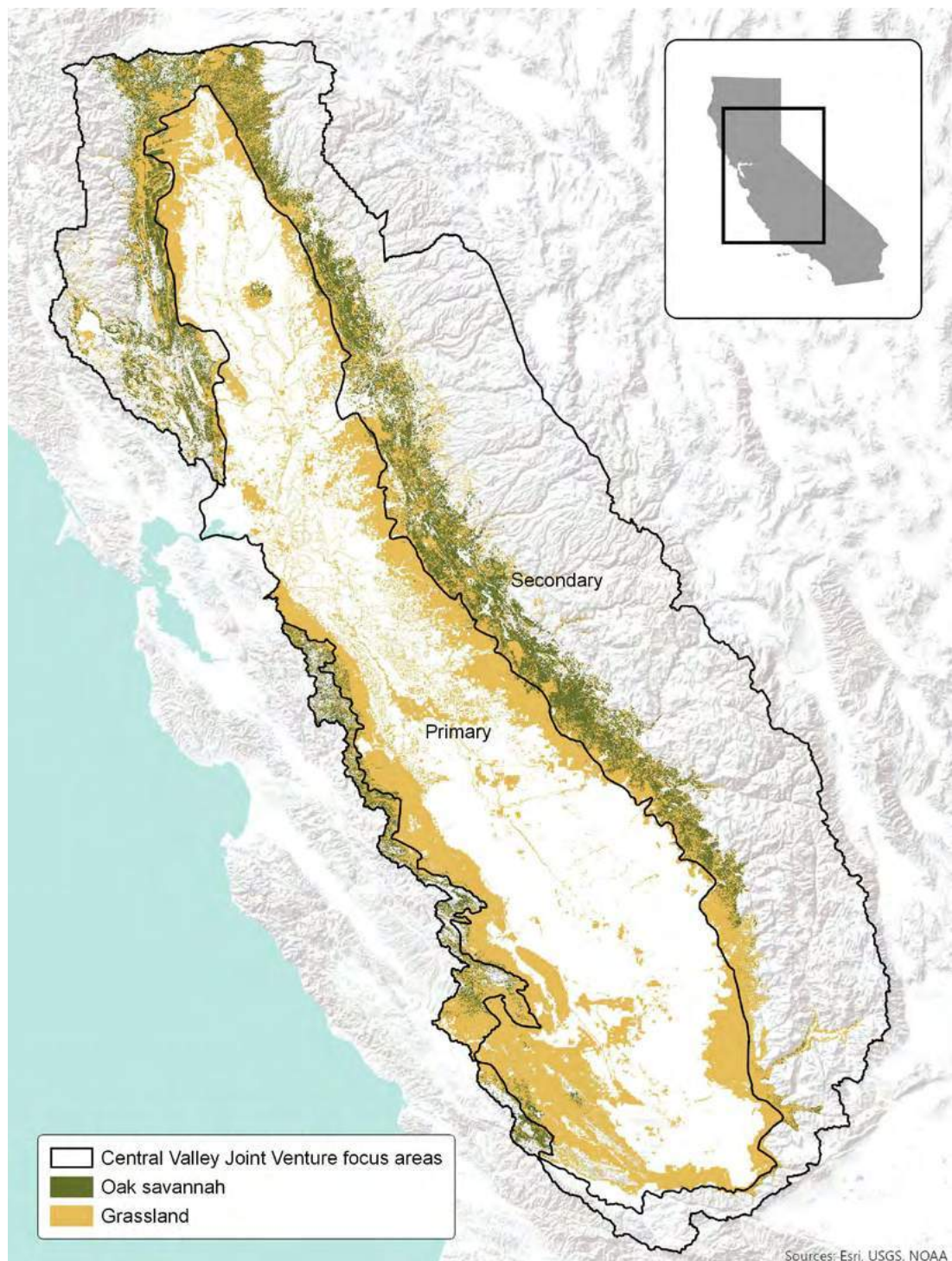

FIGURE 13.1 Central Valley Joint Venture perimeter and Primary and Secondary Focus Areas, showing extent of grassland and oak savannah habitats. Estimated current extents of grassland and oak savannah vegetation are shown up to a maximum elevation of 3,000 ft.

CURRENT CONDITIONS

Current Population Sizes and Trends

Researchers used survey data collected between 2002 and 2015 to estimate current breeding population sizes that ranged widely from very small (310 burrowing owls in the Secondary Focus Area) to large (more than 300,000 western meadowlarks in the Primary Focus Area) (Figure 13.2). Burrowing owl, loggerhead shrike, and yellow-billed magpie had the smallest population size estimates; current population sizes of northern harrier and American kestrel are unknown. Fully two-thirds of the focal species have significant long-term declining trends in the Coastal California Bird Conservation Region (BCR 32), and both horned lark and burrowing owl are estimated to have steeply declining trends, with an average decline of more than 30 percent every 10 years.

Current Habitat

The CVJV's Primary and Secondary Focus Areas currently contain an estimated six million acres of grassland habitat, with more than half (64 percent) in the Primary Focus Area on the valley floor (Table 13.2). These estimates include annual and perennial grassland and pasture. These areas also contain an estimated 1.8 million acres of oak savannah habitat, with the vast majority (94 percent) in the Secondary Focus Area, including valley oak woodland, coast oak woodland, blue oak-foothill pine, and blue oak woodland. These estimates indicate that oak savannah habitat is extremely limited in the Primary Focus Area.

As a further indicator of current habitat conditions, the finding that two-thirds of the focal species have declining population trends and two focal species have steeply declining population trends suggests significant, ongoing habitat loss and degradation. In addition, only four of the seven focal species associated with oak savannah habitat (57 percent) and two of the five focal species associated with grassland habitat (40 percent) are currently resilient, with viable or large populations in each focus area (Figure 13.2). These findings indicate there is considerable room for improvement in the restoration and enhancement of Central Valley grassland and oak savannah ecosystems.



Horned lark - Stephen Fettig

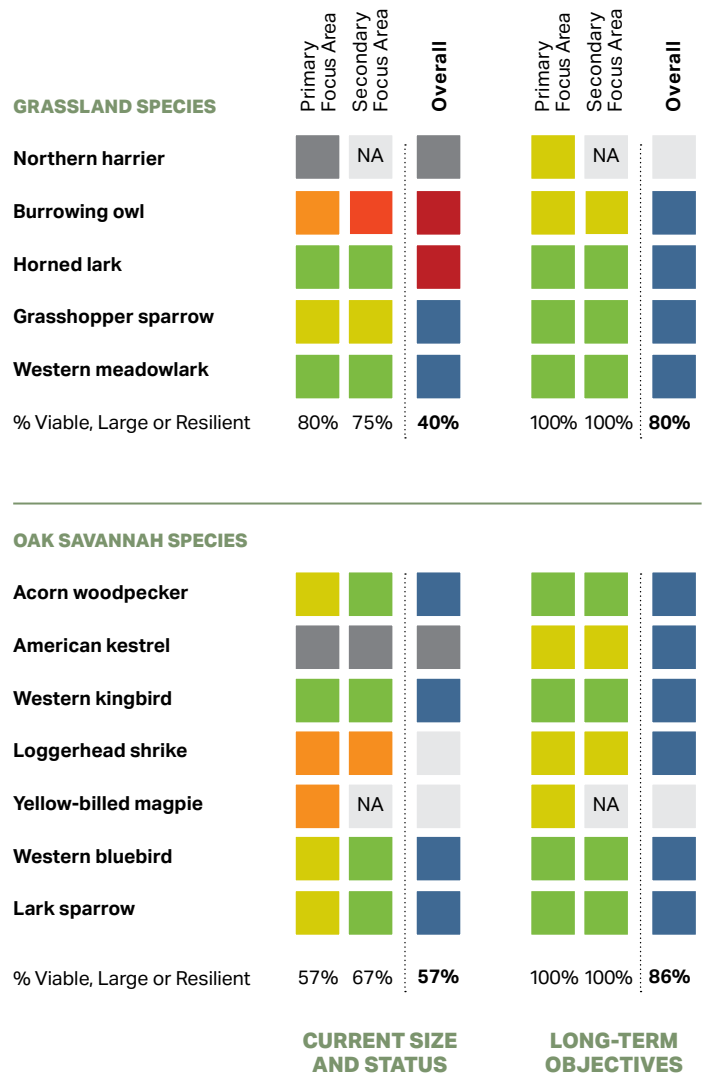

CURRENT SIZE AND STATUS

LONG-TERM OBJECTIVES

Population Status Key

Unknown	Unknown	Resilient	Resilient
Very small (<1,000)	Very small (<1,000)	Steeply declining	Steeply declining
Small (<10,000)	Small (<10,000)	Stable but vulnerable	Stable but vulnerable
Viable (>10,000)	Viable (>10,000)		
Large (>50,000)	Large (>50,000)		

FIGURE 13.2 Population status and objectives for Central Valley grassland and oak savannah bird species.

Current size and status of each focal species population, and Long-Term Objectives, grouped by grassland species (top) and oak savannah species (bottom). A status of NA (Not Applicable) in one of the focus areas means the species is not expected to breed in that focus area. A status of "unknown" means the current population size or trend is currently unknown and the species is assumed not to be viable, large, or resilient. Thus, the calculation of "% Viable, Large or Resilient" represents a minimum value.

DEVELOPING THE CONSERVATION OBJECTIVES

Population Objectives

To develop the long-term population objectives for each focal species in each region, researchers first developed a population status framework based on general principles of conservation and population biology (Dybala et al. 2017). The framework is structured as a hierarchy of four population size categories that mark milestones in becoming a genetically robust, self-sustaining, and resilient population: very small (<1,000), small (<10,000), viable (>10,000), and large (>50,000). There are two additional modifiers that describe steeply declining populations (>30 percent decline over 10 years), which are at high risk of extirpation regardless of population size, and resilient populations, which should be more capable of recovering from an environmental catastrophe in one part of the range if they have more than one self-sustaining sub-population.

To meet the conservation goal of supporting genetically robust, self-sustaining, and resilient focal species populations, this population status framework was used to define long-term (100-year) population objectives for each focal species population in each focus area. For the less common and special status species that currently have small, very small, or unknown population sizes, the CVJV set lower targets for the long-term population objectives. Population objectives for northern harrier and yellow-billed magpie were only defined for the Primary Focus Area since these species historically have scarcely ever occurred in the Secondary Focus Area (CWHR 1995; Shuford and Gardali 2008).

Density and Habitat Objectives

Because so much historical grassland and oak savannah vegetation has been lost and degraded, many of the focal species populations are likely to be limited by available habitat, and the

current densities of many of the focal species may be unusually low due to reduced habitat quality. Therefore, meeting the population objectives will require both habitat restoration and habitat enhancement efforts, to increase both the total area of habitat available to species and their average breeding densities. Long-term habitat and density objectives were defined such that achieving both will result in meeting the long-term population objectives.

For many of the focal species, researchers believe that improvements in habitat quality could produce at least half of the additional individual birds needed to meet the population objectives. This assumption was incorporated into the objectives by calculating the average breeding densities in each species' principal breeding habitat required to meet half of that species' target population size. Long-term objectives for the restoration of additional acres of habitat were defined to bridge any remaining gap to the population objectives. This assumes the same breeding densities will also be met in any newly restored habitat.

To track progress during the lifespan of this Implementation Plan (hereafter, "the Plan"), short-term (10-year) habitat objectives for additional acres needed by 2030 were set at 10 percent of the long-term objectives.

Breeding density objectives were defined last for the less common and special-status species that currently have small, very small, or unknown population sizes. These objectives were set by calculating the density required to meet the species' population objectives, once the habitat objectives are met.

Additional details on the sources of data, methods, results, and references can be found in DiGaudio et al. (2017).



(1) Image: Valley oak woodland - Llano Seco Ranch (2) Burrowing owls - Tom Grey (3) Lark sparrow - Stephen Fetting

CONSERVATION OBJECTIVES

Habitat

The Plan defines separate short-term (10-year) and long-term (100-year) habitat objectives for grassland and oak savannah, in both the Primary and the Secondary Focus Areas (Table 13.2). Where the long-term habitat objectives are equal to the current estimated extent and no additional acres are needed (i.e., grassland in the Primary Focus Area and oak savannah in the Secondary Focus Area), the objective is to maintain and enhance the current extent and ensure that no net loss occurs. Because much of this habitat already exists, the restoration needs are relatively modest. The habitat objectives represent the estimated total area of each habitat type required to enable focal species to reach the long-term population objectives in both CVJV focus areas.

Population

The long-term (100-year) population objectives are to reach >50,000 individuals for the majority of the focal species in each focus area, and >10,000 for species that currently have small, very small, or unknown population sizes (Figure 13.2). These population objectives represent the estimated population sizes needed to reach the goal of genetically robust, self-sustaining, and resilient populations.

Breeding Density

The Plan defines long-term (100-year) average breeding density objectives for each species' principal habitat type in each focus area (Table 13.3). The density objectives represent the estimated average breeding densities that could be reached with improvements in the both the quality (enhancement) and quantity (restoration) of grassland and oak savannah habitat in each focus area.

HABITAT TYPE FOCUS AREA	LONG-TERM HABITAT OBJECTIVE	CURRENT ESTIMATE	ACRES NEEDED (DIFFERENCE)	ACRES NEEDED BY 2030 (10%)
Grassland (<10% canopy cover)				
Primary	3,872,771	3,872,771	0	0
Secondary	2,277,867	2,174,499	103,367	10,337
Total	6,150,637	6,047,270	103,367	10,337
Oak Savannah (10–40% canopy cover)				
Primary	197,541	112,712	84,829	8,483
Secondary	1,672,076	1,672,076	0	0
Total	1,869,617	1,784,788	84,829	8,483

TABLE 13.2 Short-term (10-year) and long-term (100-year) habitat objectives for breeding grassland and oak savannah landbirds. Objectives are shown in acres, along with current estimates of each habitat type, the estimated additional acres needed to meet the long-term habitat objectives, and the short-term objective of meeting 10% of those acres by 2030. (Sums may not be exact, due to rounding in original data.)

SPECIES	PRIMARY FOCUS AREA	SECONDARY FOCUS AREA ^a
Grassland		
Burrowing owl	0.002	--
Grasshopper sparrow	0.020	0.020
Horned lark	*0.038	*0.059
Northern harrier	0.002	--
Western meadowlark	*0.079	*0.071
Oak Savannah		
Acorn woodpecker	0.235	*0.087
American kestrel	0.051	0.006
Lark sparrow	0.197	*0.118
Loggerhead shrike	0.029	0.004
Western bluebird	0.150	*0.037
Western kingbird	*0.208	*0.125
Yellow-billed magpie	0.051	--

^a No density objectives were defined for burrowing owl, northern harrier, or yellow-billed magpie in the Secondary Focus Area.

* Density objective is to maintain current average density.

TABLE 13.3 Long-term breeding density objectives for grassland and oak savannah focal species. Objectives are listed as individuals/acre. Species are grouped by focus area and principal breeding habitat.

APPLYING THE CONSERVATION OBJECTIVES

Habitat Objectives

The habitat objectives represent the estimate of the total area of grassland and oak savannah habitat that is required to enable focal species populations to reach the long-term population objectives, and therefore the total area required to reach the CVJV's conservation goal. Subtracting the estimated current extent of each habitat type provides the estimated additional acres needed, assuming none of the current extent is lost. Securing the required additional acres can be achieved through habitat restoration.

“Habitat restoration” is defined here as conversion of land that does not currently consist of the target land cover type into the target land cover type. For grassland and oak savannah habitat, this includes establishing new areas with native and/or naturalized grassland- and oak savannah-associated plants, that are not already shown in the CAL-FIRE 2015 GIS layer (http://frap.fire.ca.gov/data/frapgisdata-sw-fveg_download). The acreage of new grassland or oak savannah habitat created by a restoration project in one of the focus areas and up to a maximum elevation of 3,000 feet would count as contributing to these habitat objectives.

“Habitat enhancement” in this situation indicates managing existing grassland or oak savannah habitat to improve habitat quality. The acreage of enhanced grassland or oak savannah habitat should not be counted toward the habitat objectives. Instead, habitat enhancement should be measured using the breeding density objectives, as described below.

Breeding Density Objectives

The breeding density objectives can be used in several ways. At habitat restoration sites, they can be used to demonstrate that the restoration activities are creating quality habitat in which the focal species are ultimately able to meet or exceed the density objectives. Similarly, in existing habitat, they can be used to demonstrate the effectiveness of habitat enhancement activities in which the focal species' breeding densities improve and ultimately meet or exceed the density objectives. Finally, they can be used as part of a project planning process to project the potential number of individuals of each focal species that a restoration or enhancement project site may be able to support. Progress toward the breeding density objectives can be tracked through regular surveys of grassland and oak savannah breeding birds at project sites, and overall by surveying throughout each focus area.

By improving species densities, fewer acres of habitat are required to meet the population objectives, and in turn the conservation goal. Therefore, efforts to improve conditions in existing grassland and oak savannah habitat should be prioritized. Such habitat enhancement efforts might include the removal of noxious weeds, such as yellow star-thistle (*Centaurea solstitialis*), and encouraging regeneration of blue oaks (*Quercus douglasii*) and greater cover of native bunch grasses, such as purple needlegrass (*Stipa pulchra*).



Northern harrier - Tom Grey

SUCCESS STORY

LOCAL LAND TRUSTS IN THE SIERRA NEVADA FOOTHILLS

In the Sierra Nevada foothills, local land trusts can play an important role in conserving grassland and oak savannah habitat that would otherwise be threatened by development. For example, the American River Conservancy and the Sierra Foothill Conservancy have protected a combined total of over 50,000 acres of foothill rangelands, which include substantial areas of grassland and oak savannah habitat.



Bird surveys on various parcels owned by these land trusts have found thriving populations of several CVJV grassland and oak savannah focal species. In El Dorado County between 2014 and 2018, the American River Conservancy protected over 3,000 acres of healthy oak savannah habitat along the Cosumnes River that was threatened by development. The group is now working to acquire an adjacent 6,200 acres of habitat. Spring bird surveys found abundant bird life, including seven CVJV focal species and nesting golden eagles.

Both land trusts are actively working with partner biologists at Point Blue Conservation Science and the Natural Resources Conservation Service to develop, implement and evaluate management practices that enhance biodiversity and soil health.



(1-3) El Dorado Ranch, Cosumnes River - Elena DeLacy, American River Conservancy

ADDITIONAL CONSERVATION CONSIDERATIONS

Increase patch size and connectivity

There are numerous examples of relatively small-scale (<250 acres) grassland restoration projects in the Central Valley. While these sites have been readily colonized by some species (e.g., northern harriers), for certain other species (e.g., grasshopper sparrows), grassland restoration has had limited success in supporting breeding grassland birds. Researchers believe these restored grasslands are smaller than the patch size requirements for many grassland birds (DiGaudio et al. 2009; Young and DiGaudio 2011), limiting breeding success. Future restoration projects should be strategically located to improve habitat connectivity and patch size.

Manage habitat for species-specific needs

Given that each of the focal species has its own distinct set of habitat requirements (e.g., horned larks and burrowing owls prefer short-stature grassland whereas meadowlarks prefer taller grassland), managers of each restoration or enhancement project should consider what the target management species are relative to their habitat requirements and attempt to create habitat mosaics across the landscape to accommodate multiple species' needs. Recommendations have been put forward for improving habitat conditions for the grassland and oak savannah focal species; however, most recommendations are hypothetical, and evaluating their effectiveness will require further testing and validation. For example, grasshopper sparrows are associated with the perennial bunch grasses, such that increasing perennial grass cover should increase grasshopper sparrow density (Vickery 1996). Specific recommendations can be found for each focal species in the California Partners in Flight grassland bird conservation plan (CPIF in review).

Investigate the role of livestock grazing practices

Managed livestock grazing could play a significant role in enhancing grassland and oak savannah habitat for birds, especially given that the vast majority of California's grasslands and oak savannahs are currently used for livestock production (Stromberg et al. 2007). There is still much to learn, however, about rangeland management and livestock grazing practices for the benefit of birds.



(1) Cattle grazing with greater white-fronted geese at vernal pool - Joe Silveira (2) Grasshopper sparrow - Tom Grey

LITERATURE CITED

- BirdLife International. 2014. *Pica nuttalli*. The IUCN red list of threatened species 2014:e.T22705874A61893932. Available from: <http://www.iucnredlist.org/details/22705874/0> doi: <http://dx.doi.org/10.2305/IUCN.UK.2014-2.RLTS.T22705874A61893932.en>
- Byrd KB, Flint L, Alvarez P, Casey CF, Sleeter BM, Soulard CE, Flint A, Sohl T. 2015. Integrated climate and land use change scenarios for California rangeland ecosystem services: wildlife habitat, soil carbon, and water supply. *Landsc Ecol.* 30:729-750.
- Cameron DR, Marty J, Holland RF. 2014. Whither the rangeland? Protection and conversion in California's rangeland ecosystems. *PLoS One* 9(8):e103468.
- Chaplin-Kramer R, Tuxen-Bettman K, Kremen C. 2011. Value of wildland habitat for supplying pollination services to Californian agriculture. *Rangelands* 33:33-41. doi: 10.2111/1551-501x-33.3.33
- Chase MK, Geupel GR. 2005. The use of avian focal species for conservation planning in California. In: Ralph CJ, Rich TD, editors. 2005. Proceedings of the Third International Partners in Flight conference. USDA Forest Service Gen. Tech. Report PSW-GTR-191. p. 130-142.
- [CPIF] California Partners in Flight. 2000. Version 1.0. The draft grassland bird conservation plan: a strategy for protecting and managing grassland habitats and associated birds in California (B. Allen, lead author). Point Reyes Bird Observatory, Stinson Beach, CA. Available from: <http://www.prbo.org/CPIF/Consplan.html>
- [CPIF] California Partners in Flight. In review. Version 2.0. The grassland bird conservation plan: a strategy for protecting and managing grassland habitats and associated birds in California. (M. Hammond, lead author). Draft materials and species accounts currently available from: <https://griffingroups.com/groups/profile/201103/california-partners-in-flight-grassland-bird-conservation-plan>
- [CWHR] California Department of Fish and Wildlife. 1995. California Wildlife Habitat Relationships Program. Available from: <https://www.wildlife.ca.gov/Data/CWHR>
- DiGaudio R, Hickey C, Stenzel L, Page G, Geupel G. 2009. Avian monitoring on private lands: measuring bird response to easement, restoration, enhancement, and incentive programs in the Central Valley, 2004-2008. PRBO Conservation Science, Petaluma, CA. Available from: <http://www.prbo.org>
- DiGaudio, RT, Dybala KE, Seavy NE, Gardali T. 2017. Population and habitat objectives for avian conservation in California's Central Valley grassland-oak savannah ecosystems. *San Franc Estuary Watershed Sci.* 15(1):6.
- [DGP-GIC] Department of Geography and Planning and Geographical Information Center. 2003. The Central Valley Historic Mapping Project. Chico, CA: California State University.
- Dybala KE, Clipperton N, Gardali T, Golet GH, Kelsey R, Lorenzato S, Melcer Jr. R, Seavy NE, Silveira JG, Yarris GS. 2017. A General Framework for Setting Quantitative Population Objectives for Wildlife Conservation. *San Franc Estuary Watershed Sci.* 15(1):8.
- Gardali T, Seavy NE, DiGaudio RT, Comrack LA. 2012. A climate change vulnerability assessment of California's at-risk birds. *PLoS One* 7:e29507.
- Havstad KM, Peters DPC, Skaggs R, Brown J, Bestelmeyer B, Fredrickson E, Herrick J, Wright J. 2007. Ecological services to and from rangelands of the United States. *Ecol Econ.* 64:261-268. doi: 10.1016/j.ecolecon.2007.08.005
- Kroeger T, Casey F, Alvarez P, Cheatum M, Tavassoli L. 2009. An economic analysis of the benefits of habitat conservation on California rangelands. Conservation Economics White Paper. Conservation Economics Program. Washington, DC: Defenders of Wildlife. 91 pp.
- [NABC] North American Bird Conservation Initiative, U. S. C. 2014. The state of the birds 2014 report. U.S. Department of Interior, Washington, D.C., USA. Available from: http://www.stateofthebirds.org/2014/2014%20SoTB_FINAL_low-res.pdf
- [PIF] Partners in Flight Science Committee 2012. Species assessment database, version 2012. Available from <http://rmbo.org/pifassessment>
- Shuford WD, Gardali T, editors. 2008. California Bird Species of Special Concern: A ranked assessment of species, subspecies, and distinct populations of birds of immediate conservation concern in California. Studies of Western Birds 1. Western Field Ornithologists, Camarillo, California, and California Department of Fish and Game, Sacramento.
- Stromberg MR, Corbin JD, D'Antonio CM, editors. 2007. California Grasslands: Ecology and Management. University of California Press, Berkeley and Los Angeles, California.
- Vickery PD. 1996. Grasshopper sparrow (*Ammodramus saviannarum*), no. 239, The Birds of North America Online (A. Poole, Ed.). Cornell Lab of Ornithology.
- Young, A, DiGaudio R. 2011. Songbird monitoring of the Pine Creek Grassland: 2011 report to The Nature Conservancy and the U.S. Fish and Wildlife Service. PRBO Conservation Science. 3820 Cypress Dr. #11. Petaluma, CA. PRBO Contribution #1829.



1

AT-RISK BIRD SPECIES

14



2



3

CHAPTER SUMMARY

This chapter presents the results of the first effort to create a list of at-risk bird species focused specifically on the Central Valley (Shuford and Hertel 2017). Because the list includes all at-risk species found in the region—not just those with threatened or endangered status—it can be used to broaden the scope and improve the effectiveness of large-scale conservation planning efforts in the region.

How conservation objectives have been set for birds has evolved over time (CVHJV 1990; CVJV 2006; this Implementation Plan update). The 2006 Implementation Plan focused on just waterfowl, but this current Implementation Plan includes chapters for several bird groups, members of which are allied by a combination of taxonomic association, seasonal occurrence, or habitat affinity. Yet, these chapters do not cover all birds, or all key seasons or habitats for some birds. Conservation objectives in the other bird-group chapters are currently set for only 50% of the at-risk species identified, even though their populations have declined out of proportion to overall habitat loss compared to other species using the same broad habitat types. To address these gaps, this chapter presents a framework for setting conservation objectives to ensure that all at-risk species are covered in future Plan updates.

HABITAT TYPE

Virtually all of the habitat types in the Central Valley are home to at-risk bird species, including wetlands, agricultural crops, grasslands, riparian, oak woodland/oak savannah, and saltbush scrub. The habitats used and to what degree varies among species, by sub-region, and seasonally or annually depending on the management or hydrologic regime. Importantly, there are some at-risk species that are not captured elsewhere in this Plan, in part because of their habitat preferences, particularly those associated with saltbush scrub and open-water habitats.

HABITAT SUCCESS STORIES

- In 2011, The Urban Bird Foundation garnered the support of over 20 conservation organizations for a statewide Comprehensive Conservation Strategy for burrowing owls. The group was also recognized in 2012 by the California Department of Fish and Wildlife as being responsible for the state's new mitigation guidelines to protect burrowing owls.
- Since 2004 the Tricolored Blackbird Working Group has focused on halting or reversing the sharp population decline of this nomadic, colonial-nesting landbird by various means, including using innovative incentives to protect birds nesting in grain crops (see Success Story sidebar).
- In 2013, the Bank Swallow Technical Advisory Committee published the Bank Swallow Conservation Strategy for the Sacramento River Watershed, California. This collaborative group of state, federal and NGO interests produced quantitative objectives for restoration for this at-risk species. These objectives supported the development of targets that were identified as state funding priorities in the 2017 Central Valley Flood Protection Plan, which will guide near and long-term investments in flood protection projects throughout the Central Valley. This is an excellent example of how planning for an at-risk species can result in direct investments in habitat creation and species recovery.

BIRD SPECIES INCLUDE:

Examples of Central Valley at-risk bird species:



Greater sandhill crane*



Yellow-billed cuckoo****



Tricolored blackbird**



Black tern***



Burrowing owl***



Western grebe***



Snowy plover***



Short-eared owl***



Loggerhead shrike***



Northern harrier***

* Image: Bruce Miller ** Image: Ted Beedy *** Image: Tom Grey
**** Image: Ed Harper

(1) Tri-colored blackbird - Lee Karney/USFWS (2) Sacramento-San Joaquin River Delta - Steve Martarano/USFWS (3) Burrowing owls - Tom Grey

INTRODUCTION

Once a vast mosaic of wetlands, riparian forests, grasslands, oak woodlands, and saltbush scrub, California's Central Valley has been dramatically transformed over the last century. The loss of a large proportion of native habitat by conversion to agriculture, channelization and urban development (Katibah 1984; Frayer et al. 1989; CPIF 2000; DGP-GIC 2003) has caused a dramatic decline of Central Valley wildlife. Many bird species that were formerly abundant are now reduced to relatively small populations or have been entirely extirpated from the Central Valley. A number of these species have been listed as threatened or endangered by the state or federal governments; some of these have recovery or conservation plans that should guide Central Valley conservation efforts. Additional at-risk bird species identified by various conservation assessments should also be considered in Central Valley conservation activities. If possible, conservation actions for these additional at-risk species should be implemented while they are in the early stages of decline, reducing their risk of becoming threatened or endangered.

The comprehensive list of at-risk bird species in the Central Valley presented here is an important resource to guide Central Valley habitat restoration, enhancement, and management efforts. The habitat conservation objectives for more common species defined in other chapters of this Plan often overlap with the habitat needs of at-risk species. However, meeting the needs of at-risk species frequently requires more focused conservation actions, given that many at-risk species have declined out of proportion to overall habitat loss compared to other species using the same broad habitat types. After all, rare species are rare for a reason and, hence, they typically have subtler habitat needs than those of more common species. They may not respond well to restoration of general habitat types unless their more specific habitat needs are met.

Protecting, restoring, and managing habitat to benefit at-risk bird species can also provide many benefits for other native animals and plants of the Central Valley. These species, in turn, collectively benefit the people and communities of the Central Valley. For example, restoring and enhancing riparian habitat and wetlands can reduce flood risk, improve water quality, sequester carbon, and recharge groundwater (Finlayson et al. 1999; Zedler and Kercher 2005). Restored grassland and oak savannah can sequester carbon, provide habitat for pollinators, and contribute to food and fiber production (Havstad et al. 2007; Kroeger et al. 2009; Chaplin-Kramer et al. 2011; Cameron et al. 2014). All of these efforts can collectively increase property values, provide recreational opportunities, and attract wildlife viewers and hunters who help support local economies (Carver 2013; Carver and Caudill 2013; Liu et al. 2013).

CONSERVATION GOAL

The Central Valley Joint Venture's long-term goal is to increase populations of at-risk bird species in the Central Valley to robust, self-sustaining levels that will reduce or eliminate conservation concern on their behalf. Success will be measured by changes in population trajectories of the at-risk species, and, ultimately, by removal of species from this list and from the other lists from which this one was derived.



(1) Agency personnel and private landowner partnering to protect bird habitat - USFWS. (2) Fulvous whistling-duck - Tom Grey.

WHICH SPECIES ARE INCLUDED?

The CVJV identified 38 at-risk species, subspecies, or distinct populations of birds (hereafter referred to as “species”; Table 14.1). At the time of writing, eight of the 38 are listed, or are candidates for listing, as state or federally threatened or endangered; 23 are considered bird species of special concern in California at various priority levels (Shuford and Gardali 2008); and seven were chosen on the basis of their inclusion on one or more conservation lists at the national or regional level.



Loggerhead shrike - Tom Grey

SPECIES COMMON NAME (SCIENTIFIC NAME)	CONSERVATION STATUS ^a	CONSERVATION OBJECTIVES ^b	KEY HABITATS	OTHER MAJOR THREATS
Fulvous whistling-duck^c (<i>Dendrocygna bicolor</i>)	BSSC, CCV	--	Semi-permanent wetlands and grain crops	Disease
Tule greater white-fronted goose (<i>Anser albifrons elgasi</i>)	BSSC	--	Seasonal wetlands and grain crops	--
Redhead (<i>Aythya americana</i>)	BSSC	--	Semi-permanent wetlands	--
Eared grebe (<i>Podiceps nigricollis</i>)	NAWCP, WCP-32, CCV	Waterbirds	Semi-permanent wetlands; less frequently seasonal wetlands	--
Western grebe (<i>Aechmophorus occidentalis</i>)	NAWCP, WCP-32, CCV	Waterbirds	Semi-permanent wetlands	--
Yellow-billed cuckoo (western distinct population segment) (<i>Coccyzus americanus</i>)	FT, SE, BCC, BCC-32, WL, CCV	Riparian	Riparian	--
Yellow rail (<i>Coturnicops noveboracensis</i>)	BSSC, NAWCP, WCP-32, BCC, BCC-32, WL, CCV	--	Seasonal wetlands	--
California black rail (<i>Laterallus jamaicensis coturniculus</i>)	ST, NAWCP, WCP-32, BCC, BCC-32, WL, CCV	Waterbirds	Semi-permanent wetlands; less frequently riparian	--
Greater sandhill crane (<i>Grus canadensis tabida</i>)	ST, WCP-32	Waterbirds	Seasonal wetlands, grain crops, and grassland/ rangeland; less frequently forage and other row/ field crops	Crop conversion
Lesser sandhill crane (<i>Grus canadensis canadensis</i>)	BSSC, WCP-32	Waterbirds	Seasonal wetlands, grain and forage crops, and grassland/rangeland; less frequently other row/ field crops	Crop conversion
Snowy plover (interior) (<i>Charadrius nivosus</i>)	BSSC, SCC, BCC, BCC-32, WL, CCV	Non-Breeding Shorebirds	Semi-permanent wetlands (alkali); less frequently seasonal wetlands	--
Mountain plover (<i>Charadrius montanus</i>)	BSSC, SCC, BCC, BCC-32, WL	--	Row/field crops and grassland/rangeland	--
Whimbrel (<i>Numenius phaeopus</i>)	SCC, BCC, BCC-32, CCV	Non-Breeding Shorebirds	Forage crops; less frequently seasonal wetlands and grain crops	--
Long-billed curlew (<i>Numenius americanus</i>)	SCC, BCC, BCC-32, WL	Non-Breeding Shorebirds	Forage crops; less frequently seasonal wetlands, grain crops, and grassland/rangeland	--
Black tern (<i>Chlidonias niger</i>)	BSSC, NAWCP, WCP-32, CCV	Waterbirds	Grain crops; less frequently semi-permanent and seasonal wetlands	--
Forster's tern (<i>Sterna forsteri</i>)	NAWCP, WCP-32, CCV	Waterbirds	Semi-permanent wetlands; less frequently seasonal wetlands and grain crops	--
Least bittern (<i>Ixobrychus exilis</i>)	BSSC, NAWCP, WCP-32, CCV	Waterbirds	Semi-permanent wetlands	--
Bald eagle (<i>Haliaeetus leucocephalus</i>)	SE, BCC, BCC-32	--	Semi-permanent and seasonal wetlands; less frequently riparian and oak woodland/ savannah	Pollution
Northern harrier (<i>Circus cyaneus</i>)	BSSC	Grassland/oak savannah	Semi-permanent wetlands and grassland/ rangeland; less frequently grain, forage, or other row/field crops	Crop conversion

Swainson's hawk (<i>Buteo swainsoni</i>)	ST, BCC, CCV	--	Riparian, grassland/rangeland, forage and other row/field crops; less frequently grain crops and oak woodland/savannah	Crop conversion
Burrowing owl (<i>Athene cunicularia</i>)	BSSC, BCC-32	Grassland/oak savannah	Row/field crops and grassland/rangeland	Crop conversion
Long-eared owl (<i>Asio otus</i>)	BSSC, WL	--	Habitat preferences not well known; uses riparian, grassland/rangeland, forage crops and other row/field crops	--
Short-eared owl (<i>Asio flammeus</i>)	BSSC, BCC	--	Habitat preferences not well known; uses semi-permanent wetlands, grassland/rangeland, and grain, forage, and other row/field crops	--
Loggerhead shrike (<i>Lanius ludovicianus</i>)	BSSC ^d , BCC, BCC-32	Grassland/oak savannah	Grassland, oak savannah, and open shrubland; less frequently riparian and oak woodland	--
Least Bell's vireo^c (<i>Vireo bellii pusillus</i>)	FE, SE, WL, CCV	Riparian	Riparian	--
Yellow-billed magpie (<i>Pica nuttalli</i>)	BCC, BCC-32, WL, CCV	Grassland/oak savannah	Oak woodland/savannah ^e ; less frequently riparian and grain, forage, and other row/field crops	Pollution, disease
Purple martin (<i>Progne subis</i>)	BSSC	--	Very limited distribution ^f	Invasive alien species
Bank swallow (<i>Riparia riparia</i>)	ST, CCV	Riparian	Riparian	--
Oak titmouse (<i>Baeolophus inornatus</i>)	BCC, BCC-32, WL	--	Riparian and oak woodland/savannah	--
LeConte's thrasher (<i>Toxostoma lecontei</i>)	BSSC ^g , BCC, BCC-32, WL, CCV	--	Saltbush scrub	Invasive alien species
Oregon vesper sparrow (<i>Pooecetes gramineus affinis</i>)	BSSC, WL	--	Grassland/rangeland	--
Grasshopper sparrow (<i>Ammodramus savannarum</i>)	BSSC	Grassland/oak savannah	Grassland/rangeland; less frequently forage crops	Invasive alien species
"Modesto" song sparrow (<i>Melospiza melodia</i>)	BSSC, CCV	Riparian	Semi-permanent and seasonal wetlands; less frequently riparian	--
Suisun song sparrow (<i>Melospiza melodia maxillaris</i>)	BSSC, BCC-32, CCV	--	Semi-permanent wetlands; less frequently seasonal wetlands	--
Yellow-breasted chat (<i>Icteria virens</i>)	BSSC	Riparian	Riparian	--
Yellow-headed blackbird (<i>Xanthocephalus xanthocephalus</i>)	BSSC	--	Semi-permanent wetlands	--
Tricolored blackbird (<i>Agelaius tricolor</i>)	ST, BSSC, BCC, BCC-32, WL	--	Semi-permanent wetlands, grassland/rangeland, and grain and forage crops; less frequently seasonal wetlands and riparian	Crop conversion, pollution, direct mortality from harvest.
Yellow warbler (<i>Setophaga petechia</i>)	BSSC, BCC-32	Riparian	Riparian	--

^a Conservation status designations: **FE**, federally endangered, or **FT**, federally threatened species; **SE**, state endangered or **ST**, state threatened species; **SC**, candidate for state listing; **BSSC**, state bird species of special concern (Shuford and Gardali 2008); **SCC**, U.S. Shorebirds of Conservation Concern species categorized as needing Immediate Management or Management Attention (USSCPP 2015); **NAWCP**, colonial waterbird species of continental conservation concern in the North American Waterbird Conservation Plan (Kushlan et al. 2002); **WCP-32**, waterbirds of conservation concern in the Coastal California Bird Conservation Region (Shuford 2014); **BCC**, USFWS Birds of Conservation Concern (USFWS 2008); **BCC-32**, USFWS Birds of Conservation Concern in the Coastal California Bird Conservation Region (USFWS 2008); **WL**, species on the North American Bird Conservation Initiative's 2016 Watch List or subspecies on the 2014 list (Rosenberg et al. 2014; NABCI 2016); and **CCV**, species ranked among the most vulnerable to climate change (Gardali et al. 2012).

^b Population and/or habitat objectives for the species can be found in the chapter dealing with the bird/habitat group listed.

^c Largely extirpated.

^d Mainland population only (vs. Channel Island population).

^e Also uses ranch yards, wind breaks, roadside plantings, and orchards with large trees and open ground.

^f Formerly nested in the northern Central Valley in riparian habitats and in urban buildings, but a remnant population is now confined to bridge nest sites in Sacramento.

^g San Joaquin population only.

TABLE 14.1 Bird species at risk in the Central Valley: Conservation status, broad-scale habitat affinities, and major threats (from Shuford and Hertel 2017). "Other major threats" are those beyond habitat loss and degradation, which threatens all of these species. See Shuford and Hertel (2017) for additional threats (realized or potential) not yet known to have caused substantial impacts.

WHICH GEOGRAPHIC AREAS ARE INCLUDED?

The Plan evaluated at-risk species within the five planning regions of the CVJV's Primary Focus Area (Figure 14.1).

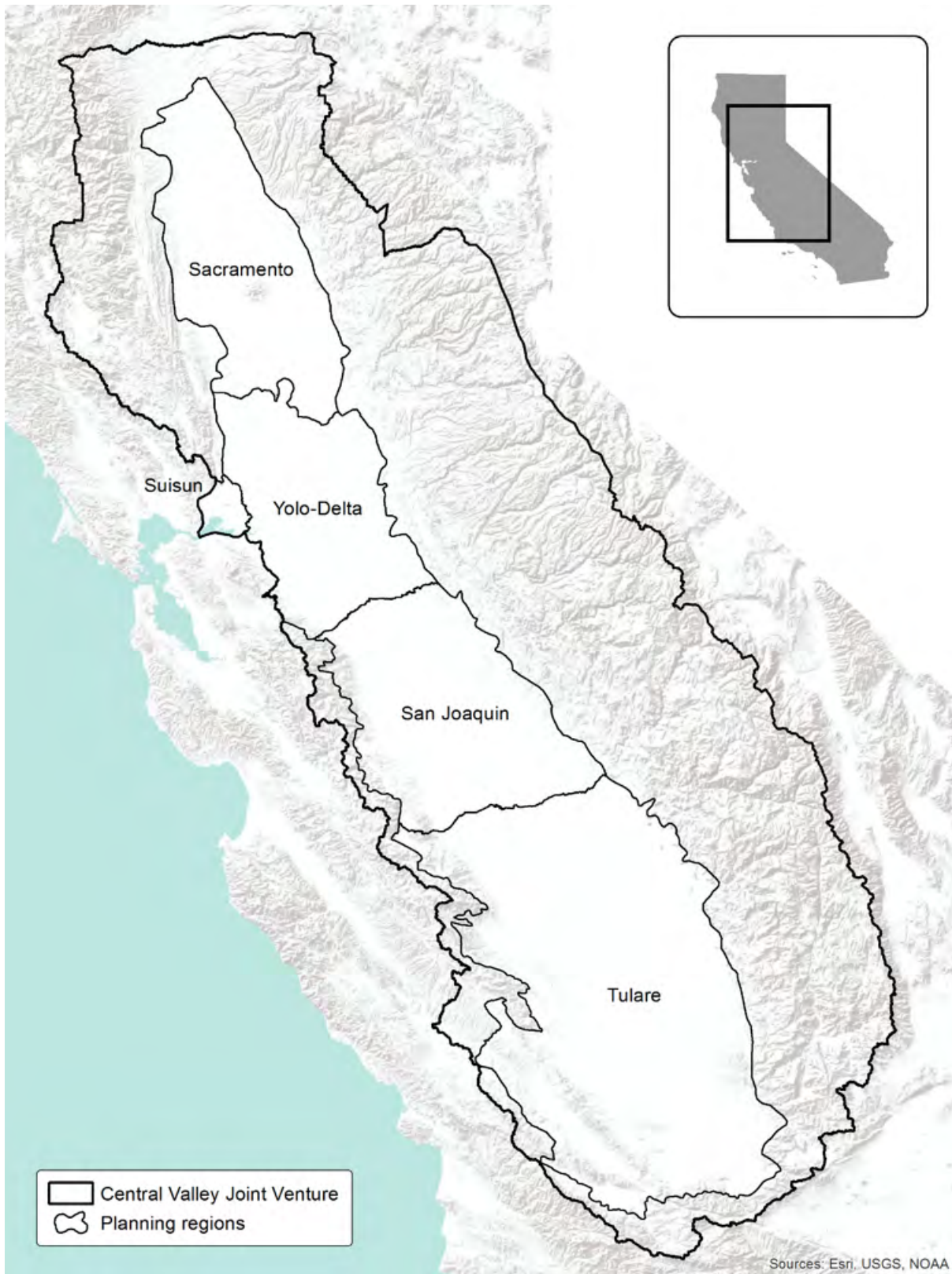

FIGURE 14.1 Central Valley Joint Venture perimeter and Primary Focus Area, showing the five planning regions.

DEVELOPING THE AT-RISK SPECIES LIST

The CVJV used a two-step process to develop the list of bird species at risk in the Central Valley (Figure 14.2). First, all bird species were considered that occur regularly in the Central Valley at some point in their life cycles in numbers sufficient to expect that conservation actions on their behalf would be likely to benefit their populations, or species that formerly met this criterion and reasonably could be expected to recover with appropriate conservation actions. Researchers then gauged which of these species should be considered at risk in the Central Valley, including species that are (1) state and/or federally threatened or endangered (or a current candidate for listing) or ranked as a California Bird Species of Special Concern; (2) ranked in the category of “Immediate Management Action” or “Management Action” on the Watch List of Shorebirds of Conservation Concern in the United States; (3) ranked as highest, high, or moderate concern at the continental level by the North American Waterbird Conservation Plan and ranked either of high or moderate concern by the Coastal California (BCR 32) Waterbird Conservation Plan; or (4) included on both the national and BCR 32 lists for U.S. Fish and Wildlife Service’s list of Birds of Conservation Concern and on the North America Bird Conservation Initiative’s national/continental Watch List.

For each of the 38 species identified as at-risk, researchers used books, peer-reviewed papers, accounts in Birds of North America Online (BNA 2016), unpublished materials, and regional experts to identify the species’ broad-scale habitat affinities, threats they face, and the season(s) and region(s) of the Central Valley they use. Affinities were considered for nine habitat types, including two wetland types, four native upland habitats, and three agricultural crop categories. Wetland types were seasonal and semi-permanent (man-

aged) wetlands (including ponds, lakes, reservoirs, rivers, or other water bodies with extensive open water). The four native upland habitats were riparian forest, oak woodland/oak savannah, grassland/rangeland, and saltbush (*At-riplex* spp.) scrub. The three categories of agricultural crops were grain crops (rice, corn, wheat, triticale, barley, etc.), forage crops (alfalfa, irrigated pasture, and other hay crops), and miscellaneous field and row crops (also including weedy and bare fallow fields).

Finally, researchers assessed the severity of known historical and current threats to at-risk birds in the Central Valley, including habitat loss (and degradation), invasive alien species, pollution, overexploitation, and disease (Wilcove et al. 1998, 2000; Shuford and Gardali 2008). “Crop conversion” (from suitable to incompatible crops, e.g., orchards or vineyards) was added as a



Bald eagle - Tom Grey

specific form of habitat loss and degradation.

Additional details on the sources of data, methods, results, and references can be found in Shuford and Hertel (2017).

TWO-STEP PROCESS TO DEVELOP A LIST OF BIRD SPECIES AT RISK IN THE CENTRAL VALLEY

STEP 1 SPECIES DETERMINATION

Species either (a) occur regularly in the Central Valley during the relevant season(s) in numbers sufficient to expect conservation success, or (b) do not currently meet these conditions but formerly did and are reasonably expected to recover with appropriate conservation.

STEP 2 SUFFICIENT CONSERVATION CONCERN IN STUDY REGION

Species meet one or more of the following criteria:

1. State or Federally Endangered – OR – California Bird Species of Special Concern
2. “Immediate Management Action” or “Management Action” on Watch List of Shorebirds of Conservation Concern
3. At Least Moderate Concern, Continental Level, N. Am. Waterbird Conservation Plan – AND – At Least Moderate Concern By the BCR 32 Waterbird Conservation Plan
4. On National and BCR 32 Lists for USFWS List of Birds of Conservation Concern – AND – the N. Am. Bird Conservation Initiative’s National/Continental Watch List

FIGURE 14.2. The two-step process to identify at-risk bird species in the Central Valley. “Species” can also indicate a subspecies or distinct population.

CURRENT CONDITIONS

Current Population Sizes, Trends, and Distribution

Many of the at-risk species lack current estimates of their population sizes and trends in the Central Valley. Available population size estimates, however, range from near zero for the nearly extirpated least Bell’s vireo to over 40,000 for the grasshopper sparrow and the “Modesto” song sparrow (DiGaudio et al. 2017; Dybala et al. 2017). The yellow-billed cuckoo, burrowing owl, bank swallow, and horned lark were all estimated to be steeply declining in the Coastal California Bird Conservation Region (BCR 32; Sauer et al. 2014), with an average decline of more than 30 percent over 10 years (DiGaudio et al. 2017; Dybala et al. 2017). Tricolored blackbird numbers have declined by more than 80 percent from historical population levels (see Success Story side bar). Populations of many waterbirds change dramatically with short-term fluctuations in precipitation, making assessment of medium to long-term trends difficult (e.g., black and Forster’s terns; Shuford et al. 2016).

The primary “season of concern” (the season[s] for which there is conservation concern in the Central Valley) for the various at-risk bird species include the breeding, non-breeding, and migration seasons and year-round (Table 14.2). Hence, the Central Valley is important to seasonally at-risk species throughout the calendar year. At-risk species are unevenly distributed among the five planning

regions of the CVJV’s Primary Focus Area, with substantial portions of the total Central Valley populations of these species occurring in the Sacramento (19 species), Tulare (16 species), San Joaquin (14 species), Yolo-Delta (13 species), and Suisun (five species) planning regions (Table 14.2).

Current Habitat

Primary habitat types in the Central Valley for at-risk birds are wetlands (18 species), various agricultural crops (eleven species), grasslands (ten species), riparian (seven species), oak woodland/oak savannah (two species), and saltbush scrub (two species) (Table 14.1; Shuford and Hertel 2017). As detailed in the other bird chapters, the current extent of habitat types varies by sub-region. The extent of some types varies greatly seasonally and annually, depending on the timing and extent of intentional flooding in managed wetlands and crops (during irrigation and postharvest) as well as natural flooding more broadly during periods of extreme precipitation and runoff. Some at-risk species use habitats not included elsewhere in the Plan, such as saltbush scrub, which was formerly widespread in the San Joaquin and Tulare planning regions but has declined greatly in extent in parallel with decreasing numbers of the LeConte’s thrasher (Fitton 2008). Likewise, some species (e.g., western grebe) use reservoirs and other open water bodies that are not accounted for in estimates of wetland extent in other bird chapters.

SPECIES	SEASON OF CONCERN	SACRAMENTO	SUISUN	YOLO-DELTA	SAN JOAQUIN	TULARE
Fulvous whistling-duck	breeding	--	--	--	--	•
Tule gr. white-fronted goose	wintering	●	•	--	--	
Redhead	breeding	●	--	--	●	●
Eared grebe	breeding	--	--	--	•	●
Western grebe	breeding	●	--	•	●	●
Yellow-billed cuckoo	breeding	•	--	--	--	--
Yellow rail	wintering	--	•	--	--	--
California black rail	year-round	●	●	●	--	--
Greater sandhill crane	wintering	●	--	●	•	--
Lesser sandhill crane	wintering	•	--	●	●	●
Snowy plover (interior)	breeding	--	--	•	•	●
Mountain plover	wintering	•	--	•	●	●
Whimbrel	migration	•	•	•	●	●
Long-billed curlew	non-breeding	•	•	●	●	●

Black tern	breeding	●	--	--	•	•
Forster's tern	breeding	--	--	--	•	●
Least bittern	breeding	●	•	•	•	●
Bald eagle	year-round	●	•	•	•	•
Northern harrier	breeding	●	●	●	●	●
Swainson's hawk	breeding	●	•	●	●	•
Burrowing owl	breeding	●	•	●	●	●
Long-eared owl	breeding	•	--	--	--	•
Short-eared owl	breeding	•	●	•	•	•
Loggerhead shrike	breeding	•	•	●	●	●
Least Bell's vireo	breeding	—	--	--	•	--
Yellow-billed magpie	year-round	●	--	●	•	•
Purple martin	breeding	•	--	--	--	--
Bank swallow	breeding	●	•	--	--	--
Oak titmouse	year-round	●	●	●	●	•
LeConte's thrasher	year-round	--	--	--	--	•
Oregon vesper sparrow	wintering	●	--	●	●	●
Grasshopper sparrow	breeding	•	?	•	•	--
"Modesto" song sparrow	year-round	●	--	●	--	--
Suisun song sparrow	year-round	--	●	--	--	--
Yellow-breasted chat	breeding	●	--	•	•	•
Yellow-headed blackbird	breeding	●	•	●	●	●
Tricolored blackbird	breeding	●	•	•	●	●
Yellow warbler	breeding	•	--	--	•	--

Distribution across the five planning regions is designated as:

- **Substantial:** This planning region supports a substantial portion of the species' population in the Central Valley. This category not used at all if the Valley-wide population of the species is very small.
- **Low to Modest:** This planning region supports a low to modest portion of the species' population in the Central Valley; or, the species occurs in the indicated planning region(s), but the entire population in the Valley is very small.

TABLE 14.2 Patterns of current distribution of at-risk species during their "season of concern," across five planning regions of the Central Valley (Figure 14.1). For species that occur in the Central Valley in more than one season (breeding, wintering, migration), the "season of concern" is the season for which there is conservation concern. "Non-breeding" encompasses wintering and migration seasons. "Year-round" indicates there is conservation concern for this species in the Valley during every season.

CONSERVATION OBJECTIVES

The Plan does not define specific habitat or population objectives for at-risk species, except those that are included within one of the other bird chapters (referenced in Table 14.1). Of the 38 species identified as at risk, 19 (50 percent) have habitat and population objectives developed in other chapters of this Plan. Another 14 species use habitats in which species of their taxonomic or habitat group were evaluated but the at-risk species were not selected as focal species; still, some of these species are likely to benefit to some degree from the habitat objectives defined in the other chapters. Only five species were not otherwise addressed in the current Plan: bald eagle, purple martin, LeConte's thrasher, Suisun song sparrow, and yellow-headed blackbird.



(1) Water control structure, Gray Lodge Wildlife Area - Ducks Unlimited
(2) Tricolored blackbird flock in a field farmed for silage - Samantha Arthur

CONSERVATION CONSIDERATIONS FOR AT-RISK SPECIES

Framework for Setting Objectives in Future Plan Updates

The CVJV endorses a framework for setting conservation objectives for at-risk species in the future that includes (1) evaluating assumptions about limiting factors, (2) considering adopting objectives already set for threatened or endangered species, (3) assessing whether objectives set for species groups or focal species meet the needs of at-risk species otherwise lacking objectives, (4) applying established methods to at-risk species with respect to habitats or seasons not currently addressed, and (5) determining whether new information is needed to effectively set objectives.

Unique habitats and species

As noted earlier, some habitats important to at-risk species are not included in other chapters of this Plan. LeConte's thrasher is the only species dependent solely on saltbush scrub and so its conservation and management require a special focus on this habitat type. Additionally, purple martins currently nest in the Central Valley only under bridges in the Sacramento region (Airola and Williams 2008; Airola et al. 2014), but at present, the CVJV Plan does not consider urban cover types for conservation. Some species with very specialized ecological needs, such as the tricolored blackbird, face difficult conservation challenges, which may best be addressed by species-specific working groups (TBWG 2009).

Multiple habitats

Some at-risk species use multiple habitats but currently have conservation objectives set for only one habitat. The northern harrier, for example, uses both grassland and wetland habitats, but conservation objectives have been set only for grasslands. Still, the wetland objectives that the Plan establishes for other taxonomic groups (e.g., breeding shorebirds and waterbirds) can also benefit the northern harrier, yellow-headed blackbird, and other at-risk species that use wetlands, as long as their needs are taken into consideration in habitat restoration, enhancement, and management decisions.

Multiple Threats

There are multiple major threats for at-risk species in the Central Valley. The greatest of these is habitat loss and degradation, which affects all 38 species. Other important threats are crop conversion (compatible to incompatible; six species), invasive alien species (three species), pollution (e.g., pesticides or other contaminants; three species), and disease (two species) (Table 14.1).

For some at-risk species, limiting factors have changed over time or are obscure, complicating conservation efforts. The purple martin, for example, formerly nested in riparian trees

in the Sacramento Valley, but declines in its populations were closely linked to the expansion of the European starling (*Sturnus vulgaris*), which outcompetes martins for nesting cavities (Airola and Williams 2008). Starlings are no longer a major threat to the small remnant population of purple martins breeding under bridges in the Sacramento region (Airola et al. 2014). However, new factors have been contributing to a sharp decline in this martin population since 2006, including predation by American kestrels (*Falco sparverius*), vehicle collisions, and, perhaps, the large increase in use of neonicotinoid pesticides (Airola et al. 2014).

Similarly, the yellow-billed cuckoo continues to decline in the Sacramento Valley despite large-scale riparian habitat restoration over the past 30 years. An estimated 97 percent of suitable restored habitat appears to be unoccupied (Dettling et al. 2015). Hence the primary limiting factor for cuckoos may not currently be suitable breeding habitat in the Central Valley, but instead could be any of several other factors such as limitations of food resources, or the habitat quantity or quality on their wintering grounds or at migratory stopovers (Dettling et al. 2015). Because of the substantial losses of historical habitat in the Central Valley, the first assumption is that habitat loss and degradation is the primary limiting factor for most at-risk species. However, when habitat restoration appears to have limited success, further study is required to guide the most strategic conservation actions that should be considered, particularly for migratory species that spend large portions of their annual cycle outside the Central Valley.

Recovery Plans for Threatened and Endangered Species

Of the eight at-risk bird species in the Central Valley that are currently state or federally listed, four have a recovery or conservation plan: Swainson's hawk (FOSH 2009), least Bell's vireo (USFWS 1998), bank swallow (CDFG 1992; BANS-TAC 2013), and tricolored blackbird (TBWG 2009). Of the four, only the plans for the vireo and the swallow have quantitative population or habitat objectives. In many cases, these recovery plans include detailed recommendations for the restoration and management of habitat for these species. When implementing restoration projects designed to meet the CVJV habitat objectives, it is strongly recommended that practitioners consult these recovery plans to ensure that any unique habitat requirements for at-risk species are met.

SUCCESS STORY

TRICOLORED BLACKBIRD WORKING GROUP

The Tricolored Blackbird Working Group was formed in 2004 to bring together state, federal, and academic biologists, non-governmental organizations, and industry representatives to address the population decline of tricolored blackbirds. This colonial-nesting species, found almost exclusively in California, has seen a decline of more than 80 percent from historical population levels. The working group's multifaceted, cooperative approach focuses on voluntary conservation actions.

Coordinated by Audubon California, the working group developed an updated conservation plan (TBWG 2009) and has collaborated with others to conduct triennial population surveys, enhance wetland and upland habitat, and protect tricolored blackbird nesting colonies established in forage crops (e.g., triticale and wheat).

Partnering with the working group, the Natural Resources Conservation Service enrolls farmers in practices to delay harvest of forage crops, thus allowing tricolored blackbird colonies to complete the nesting cycle. This effort has significantly reduced tricolored blackbird mortality, saving the reproductive output of more than 200,000 nesting birds in the past four years.



(1) Biologists banding a tricolored blackbird - USFWS (2) Tricolored blackbirds - Jerry Ting



LITERATURE CITED

- Airola DA, Cousens B, Kopp D. 2014. Accelerating decline of the Sacramento Purple Martin breeding population in 2014: what are the possible causes? *CVBC Bulletin* 17(1):12–22. Available from: <http://www.cvbirds.org/bulletin/downloads/volume-17/>
- Airola DA, Williams BDC. 2008. Purple Martin (*Progne subis*). In: Shuford WD, Gardali T, editors. 2008. California Bird Species of Special Concern 2006: a ranked assessment of species, subspecies, and distinct populations of birds of immediate conservation concern in California. *Studies of Western Birds* 1. Camarillo (CA): Western Field Ornithologists and Sacramento (CA): California Department of Fish and Game. p. 293–299. Available from: <http://www.dfg.ca.gov/wildlife/nongame/ssc/birds.html>
- [BANS-TAC] Bank Swallow Technical Advisory Committee. 2013. Bank Swallow (*Riparia riparia*) conservation strategy for the Sacramento River watershed, California. Version 1.0. Available from: <http://www.sacramento-river.org/bans/>
- [BNA] Birds of North America (P. Rodewald, Ed.). 2016. Ithaca (NY): Cornell Lab of Ornithology. Available from: <http://bna.birds.cornell.edu/bna/>
- Cameron DR, Marty J, Holland RF. 2014. Whither the rangeland? Protection and conversion in California's rangeland ecosystems. *PLoS ONE* 9(8):e103468. doi: 10.1371/journal.pone.0103468
- Carver E. 2013. Birding in the United States: a demographic and economic analysis. Arlington, Virginia: U.S. Fish and Wildlife Service, Division of Economics. Available from: <https://www.fws.gov/southeast/economicImpact/pdf/2011-BirdingReport--FINAL.pdf>
- Carver E, Caudill J. 2013. Banking on nature: The economic benefits to local communities of National Wildlife Refuge visitation. Washington, D.C.: U.S. Fish and Wildlife Service, Division of Economics. Available from: <http://digitalmedia.fws.gov/cdm/singleitem/collection/document/id/1832/rec/1>
- [CDFG] California Department of Fish and Game. 1992. Recovery plan: Bank Swallow (*Riparia riparia*). Prepared by Nongame Bird and Mammal Section Wildlife Management Division. Sacramento (CA): California Department of Fish and Game. Nongame bird and mammal section report 93.02. 27 p. Available from: <https://nrm.dfg.ca.gov/FileHandler.ashx?DocumentID=2945>
- Chaplin-Kramer R, Tuxen-Bettman K, Kremen C. 2011. Value of wildland habitat for supplying pollination services to Californian agriculture. *Rangelands* 33:33–41. doi: 10.2111/1551-501x-33.3.33
- [CPIF] California Partners in Flight. 2000. Version 1.0. The draft grassland bird conservation plan: a strategy for protecting and managing grassland habitats and associated birds in California (B. Allen, lead author). Point Reyes Bird Observatory, Stinson Beach, CA. Available from: <http://www.prbo.org/CPIF/Consplan.html>
- [CVHJV] Central Valley Habitat Joint Venture. 1990. Central Valley Habitat Joint Venture Implementation Plan — a component of the North American Waterfowl Management Plan. Sacramento (CA): U.S. Fish and Wildlife Service. 102 p. Available from: http://www.centralvalleyjointventure.org/assets/pdf/cvjv_implementation_plan.pdf
- [CVJV] Central Valley Joint Venture. 2006. Central Valley Joint Venture Implementation Plan – Conserving Bird Habitat. Sacramento (CA): U.S. Fish and Wildlife Service. 261 p. Available from: http://www.centralvalleyjointventure.org/assets/pdf/CVJV_fnl.pdf
- Detting MD, Seavy NE, Howell CA, Gardali T. 2015. Current status of Western Yellow-billed Cuckoo along the Sacramento and Feather Rivers, California. *PLoS ONE* 10(4):e0125198. doi: 10.1371/journal.pone.0125198
- [DGP-GIC] Department of Geography and Planning and Geographical Information Center. 2003. The Central Valley Historic Mapping Project. Chico, CA: California State University. Available from: http://www.waterboards.ca.gov/waterrights/water_issues/programs/bay_delta/docs/cmnt081712/sldmwa/csuchicodptofgeographyandplanningcentralvalley.pdf
- DiGaudio RT, Dybala KE, Seavy NE, Gardali T. 2017. Population and habitat objectives for avian conservation in California's Central Valley grassland ecosystems. *San Franc Estuary Watershed Sci.* 15(1):6.
- Dybala KE, Clipperton N, Gardali T, Golet GH, Kelsey R, Lorenzato S, Melcer R Jr, Seavy NE, Silveira JG, Yarris GS. 2017. Population and habitat objectives for avian conservation in California's Central Valley riparian ecosystems. *San Franc Estuary Watershed Sci.* 15(1):5.
- Finlayson CM, Davidson NC, Spiers AG, Stevenson NJ. 1999. Global wetland inventory – current status and future priorities. *Mar Freshw Res.* 50:717–727. doi: 10.1071/MF99078
- Fitton SD. 2008. Le Conte's Thrasher (*Toxostoma lecontei*). In: Shuford WD, Gardali T, editors. 2008. California Bird Species of Special Concern 2006: a ranked assessment of species, subspecies, and distinct populations of birds of immediate conservation concern in California. *Studies of Western Birds* 1. Camarillo (CA): Western Field Ornithologists and Sacramento (CA): California Department of Fish and Game. p. 321–326. Available from: <http://www.dfg.ca.gov/wildlife/nongame/ssc/birds.html>
- [FOSH] Friends of the Swainson's Hawk. 2009. Conservation strategy for Swainson's Hawks in California. Sacramento (CA): Friends of the Swainson's Hawk. Available from: <http://www.swainsonshawk.org/Images/Conservation%20Plan%2009%20final.pdf>
- Frayser WE, Peters DD, Pywell HR. 1989. Wetlands of the California Central Valley: status and trends: 1939 to mid-1980's. Portland, OR: U.S. Fish and Wildlife Service. Available from: http://www.fwspubs.org/doi/suppl/10.3996/012014-JFWM-003/suppl_file/012014-jfwm-003.s10.pdf
- Gardali T, Seavy NE, DiGaudio RT, Comrack LA. 2012. A climate change vulnerability assessment of California's at-risk birds. *PLoS ONE* 7:e29507.
- Havstad KM, Peters DPC, Skaggs R, Brown J, Bestelmeyer B, Fredrickson E, Herrick J, Wright J. 2007. Ecological services to and from rangelands of the United States. *Ecol Econ.* 64:261–268. doi: 10.1016/j.ecolecon.2007.08.005
- Katibah EF. 1984. A brief history of riparian forests in the Central Valley of California. In: Warner RE, Hendrix KM, editors. *California Riparian Systems: Ecology, Conservation, and Productive Management*. Berkeley: University of California Press. p. 24–30. Available from: <http://ark.cdlib.org/ark:/13030/ft1c6003wp/>
- Kroeger T, Casey F, Alvarez P, Cheatum M, Tavassoli L. 2009. An economic analysis of the benefits of habitat conservation on California rangelands. Conservation Economics White Paper. Conservation Economics Program. Washington, DC: Defenders of Wildlife.
- Kushlan JA, Steinkamp MJ, Parsons KC, Capp J, Cruz MA, Coulter M, Davidson I, Dickson L, Edelson N, Elliot R, et al. 2002. Waterbird Conservation for the Americas: The North American Waterbird Conservation Plan. Washington, D.C.: Waterbird Conservation for the Americas. Available from: http://www.waterbirdconservation.org/pdfs/plan_files/complete.pdf
- Liu X, Taylor LO, Hamilton TL, Grigelis PE. 2013. Amenity values of proximity to National Wildlife Refuges: An analysis of urban residential property values. *Ecol Econ.* 94:37–43. doi: 10.1016/j.ecolecon.2013.06.011
- [NABC] North American Bird Conservation Initiative. 2016. The state of North America's birds 2016: species assessment summary. Ottawa (ON): Environment and Climate Change Canada. Available from: <http://www.stateofthebirds.org/2016/resources/species-assessments/>
- Rosenberg KV, Pashley D, Andres B, Blancher PJ, Butcher GS, Hunter WC, Mehlman D, Panjabi AO, Parr M, Wallace G, Wiedenfeld D. 2014. The state of the birds 2014 watch list. Washington (DC): North American Bird Conservation Initiative, U.S. Committee. Available from: http://www.stateofthebirds.org/2014/habitats/2014%20SotB%20Watch%20List_FINAL.pdf

- Sauer JR, Hines JE, Fallon JE, Pardieck KL, Ziolkowski DJ Jr, Link WA. 2014. The North American breeding bird survey, results and analysis 1966-2013. Version 01.30.2015. Laurel (MD): USGS Patuxent Wildlife Research Center. Available from: <http://www.mbr-pwrc.usgs.gov/bbs/bbs.html>
- Shuford WD. 2014. Coastal California (BCR 32) Waterbird Conservation Plan: Encompassing the coastal slope and Coast Ranges of central and southern California and the Central Valley. Sacramento: U.S. Fish and Wildlife Service. Available from: http://www.centralvalleyjointventure.org/assets/pdf/BCR32_WaterbirdCon_interactive_10FEB14.pdf
- Shuford WD, Gardali T, editors. 2008. California Bird Species of Special Concern 2006: a ranked assessment of species, subspecies, and distinct populations of birds of immediate conservation concern in California. Studies of Western Birds 1. Camarillo (CA): Western Field Ornithologists and Sacramento (CA): California Department of Fish and Game; 450 p. Available from: <http://www.dfg.ca.gov/wildlife/nongame/ssc/birds.html>
- Shuford WD, Hertel M, 2017. Bird species at risk in California's Central Valley: A framework for setting conservation objectives. San Franc Estuary Watershed Sci. 15(1):article 7. doi: 10.15447/sfews.2017v15iss1art7
- Shuford, WD, Sesser KA, Strum KM, Haines DB, and Skalos DA. 2016. Numbers of terns breeding inland in California: Trends or tribulations? West Birds 47:182-213. doi: 10.21199/WB47.3.1
- [TBWG] Tricolored Blackbird Working Group. 2009. Conservation plan for the Tricolored Blackbird (*Agelaius tricolor*). 2.0 Update. Kester S, editor. San Francisco (CA): Sustainable Conservation.
- [USFWS] U.S. Fish and Wildlife Service. 1998. Draft Recovery Plan for the least Bell's vireo (*Vireo bellii pusillus*). Portland, OR: U.S. Fish and Wildlife Service. Available from: https://ecos.fws.gov/tess_public/profile/speciesProfile.action?spcode=B067
- [USFWS] U.S. Fish and Wildlife Service. 2008. Birds of Conservation Concern 2008. Arlington (VA): U.S. Fish and Wildlife Service, Division of Migratory Bird Management. Available from: <https://www.fws.gov/migratorybirds/pdf/grants/BirdsofConservationConcern2008.pdf>
- [USSCPP] US Shorebird Conservation Plan Partnership. 2015. US Shorebirds of Conservation Concern 2015, U.S. Fish and Wildlife Service, Division of Migratory Bird Management, Falls Church, Virginia. 2016 update available from: <http://www.shorebirdplan.org/science/assessment-conservation-status-shorebirds>
- Wilcove DS, Rothstein D, Dubow J, Phillips A, Losos E. 1998. Quantifying threats to imperiled species in the United States: assessing the relative importance of habitat destruction, alien species, pollution, overexploitation, and disease. BioScience 48:607-615. doi: <http://dx.doi.org/10.2307/1313420>
- Wilcove DS, Rothstein D, Dubow J, Phillips A, Losos E. 2000. Leading threats to biodiversity: What's imperiling U.S. species. In: Stein BA, Kutner LS, Adams JS, editors. 2000. Precious heritage: the status of biodiversity in the United States. New York (NY): Oxford University Press. p. 239-254.
- Zedler JB, Kercher S. 2005. Wetland resources: Status, trends, ecosystem services, and restorability. Annu Rev Environ Resour. 30:39-74. doi: 10.1146/annurev.energy.30.050504.144248

GLOSSARY

TERM	DEFINITION
10-year goal	See Short-term goal.
100-year goal	See Long-term goal.
Acquisition	The purchasing of land in fee-title (complete ownership) or placing land under a conservation easement to protect it from development and/or with the intention to restore or enhance habitat.
Adaptive management	A systematic approach integrating project design, management and monitoring to provide a framework to systematically test assumptions, promote learning and supply timely information to improve management decisions. (See also Strategic Habitat Conservation.)
Association of Joint Venture Management Boards (AJVMB)	An organization comprised of board members from the 21 North American migratory bird joint ventures. The AJVMB works closely with joint venture partners to share messages with legislators and other decision makers (MBJV 2019).
Assumption	A statement that is believed to be true, but is uncertain, such as the cause-and-effect relationship between a management action and its effect on a conservation target.
Basin	A geographic area defined by hydrologic, geologic and floristic information.
Best available science	A synthesis of the most reliable knowledge at a point in time, derived from scientific inquiry defined by the following criteria: The questions are clearly stated; the investigation is well designed; and the results are analyzed logically, documented clearly and may be subjected to peer review (Sullivan et al. 2006).
Biological diversity, biodiversity	The variety of life and its processes, including the variety of living organisms, the genetic differences among them, and the communities and ecosystems in which they occur.
Biological population	All individuals of the same species living together in a defined area at the same time. This area should be sufficiently large that changes in the population's size are primarily due to births and deaths, not movement. However, the size of this area can be difficult to define, especially for mobile species, leading to the use of "management population." (See also Management population.)
Boundary, CVJV	The line that marks the limits of the Central Valley Joint Venture's geographic coverage area. (See also Geographic area, CVJV.)
California Floristic Province	The primary focus area of the Plan is based on the California Floristic Province as identified by The Jepson Herbarium. This is the largest and most botanically diverse geographic unit in California, comprising all of California west of the Great Basin Province in the north and the Desert Province in the south (Jepson Herbarium 2019).
Central Valley Landscape Conservation Project (CVLCP)	A project that identified climate-smart conservation actions that will maximize the adaptive capacity of priority species, habitats and ecosystems to support an ecologically connected Central Valley landscape. (CVLCP 2017).
Central Valley Project (CVP)	A network of dams, reservoirs, canals, hydroelectric power plants and other facilities that provides flood protection for the Central Valley and supplies water for agriculture, as well as for domestic and industrial water in the Valley and to several major urban centers. The CVP, a federal project, also produces electrical power and offers various recreational opportunities as well as water to restore and protect fish and wildlife.
Central Valley Project Improvement Act (CVPIA)	A federal law that mandates changes in management of the Central Valley Project for the protection, restoration and enhancement of fish and wildlife. It requires the Secretary of the Interior to provide firm water supplies of suitable quality to maintain and improve wetland habitat areas identified in the act.
Climate-Smart Conservation	Employs principles for designing and carrying out conservation in the face of a changing climate. Principles include: Act with intentionality through linking actions to impacts; manage for change, not just persistence; reconsider goals, not just strategies; integrate adaptation into existing work (Stein et al. 2014).

GLOSSARY

TERM	DEFINITION
Conservation objectives	Science-based targets for focal species population size and/or density, and the quantity and quality of habitat types needed to support those desired populations. Includes specific, measurable, results-oriented and time-fixed outcomes that measure incremental progress toward achieving conservation goals.
Conservation target	An element of biodiversity that a plan or project has chosen to focus on, such as a species, habitat, or ecological system.
Cost-share	Programs available to private landowners through various federal or state agencies and/or private conservation organizations. Typical cost-share habitat improvement programs pay for a percentage of the agreed-upon habitat restoration and/or enhancement activities. In turn, the landowner agrees to maintain the improvements for a given period of time. Cost-share programs may also be known as incentive programs.
CVJV partner	An individual or organization who works with the Central Valley Joint Venture (CVJV) to achieve the Implementation Plan's conservation objectives. They may or may not be a board member or belong to a member organization.
CVPIA refuges	Central Valley Project Improvement Act (CVPIA) refuges consist of 19 areas on federal National Wildlife Refuges (NWR), state Wildlife Areas (WA), and one privately-managed wetland complex. These include Sacramento NWR; Delevan NWR; Colusa NWR; Sutter NWR; units of San Luis NWR including East Bear Creek, Freitas, Kesterson, San Luis, and West Bear Creek; Merced NWR; Pixley NWR; Kern NWR; Gray Lodge WA; Los Banos WA; units of Los Banos WA including Salt Slough and China Island; Volta WA; Mendota WA; and the private wetlands of the Grassland Resource Conservation District.
Demonstration project	A project primarily employing and displaying new techniques to further verify outcomes, that will be used as a case study for other projects in the future.
Easement	A voluntary real estate transaction in which all or a portion of a property's development rights are purchased from a landowner to protect resource values on private lands (USFWS 2015a).
Ecological Reserve	Designation given to certain lands owned or managed by the California Department of Fish and Wildlife as a way of regulating appropriate use. This designation is usually reserved for land with special status plants, animals, or vegetation types (CDFW 2015). (Compare to Wildlife Area.)
Ecoregion	An area defined by a combination of biological, social and geographic criteria. A system of related, interconnected ecosystems.
Ecosystem	A dynamic and interrelated complex of plant and animal communities and their associated nonliving environments.
Ecosystem services	The beneficial outcomes for the natural environment or for people that result from ecosystem functions. Some examples are support of the food chain, harvesting of animals or plants, clean water, or scenic views. For an ecosystem to provide services to humans, some interaction with, or at least some appreciation by humans, is required (CDFW 2015).
Endangered species, federal	A plant or animal species listed under the Endangered Species Act of 1973, as amended, that is in danger of extinction throughout all or a significant portion of its range. Populations of these species are at critically low levels or their habitats have been degraded or depleted to a significant degree (USFWS 1998).
Endangered species, state	A plant or animal species in danger of becoming extinct in a particular state within the near future, if factors contributing to its decline continue. Populations of these species are at critically low levels or their habitats have been degraded or depleted to a significant degree (CDFW 2019).
Enhancement	The physical manipulation of a site to improve ecological functions and increase the quality of habitat. Also includes infrastructure improvements (e.g., levees, water control structures, pumps, etc.) to increase habitat management capability.
Environmental education	A process that allows individuals to explore environmental issues, engage in problem solving, and take action to improve the environment. As a result, individuals develop a deeper understanding of environmental issues and have the skills to make informed and responsible decisions (EPA). May include education, outreach, stewardship, and access activities.
Extirpated	Locally extinct; a species that has disappeared from a given area.

GLOSSARY

TERM	DEFINITION
Farm Bill	The primary agricultural and food policy tool of the U.S. government. Beginning in 1933, farm bills have included titles on commodity programs, trade, rural development, farm credit, conservation, agricultural research, food and nutrition programs, marketing and others. The Farm Bill is passed approximately every 5 years and is under the purview of the U.S. Department of Agriculture. As of this Plan, the current Farm Bill is the Agriculture Improvement Act of 2018.
Flooded agriculture	Agricultural crops (e.g., rice, corn) that are inundated with water to manage vegetation (e.g., stimulate growth or stubble decomposition), increase access to waste grain and invertebrates for waterfowl, shorebird, and other waterbird consumption, or for other purposes.
Geographic area, CVJV	The region where the CVJV has formally accepted the responsibility of implementing national bird conservation planning and has received general acceptance in the bird conservation community for this responsibility. (See also Boundary, CVJV.)
Geographic Information System (GIS)	An organized assembly of people, data, techniques, computers, and programs for acquiring, analyzing, storing, retrieving, and displaying spatial information about the real world (CDFW 2015).
GIS layer	Geographic Information Systems document and present data about multiple variables, each in a separate layer. Layers can be combined to give a landscape-level view of a geographical area.
Goal	A formal statement detailing the desired impact of a plan or project, such as the desired future condition of a conservation target.
Grassland	A landscape dominated by grasses and other herbaceous plant species with less than 10% woody cover (DiGaudio et al. 2017)
Grassland Resource Conservation District (GRCD)	One of the 19 wetland areas collectively identified as refuges in the Central Valley Project Improvement Act. It contains approximately 75,000 acres and is composed primarily of privately-owned hunting clubs and wildlife-beneficial agriculture.
Grassland Water District (GWD)	A California Water District formed under Section 34000 of the State Water Code. The majority of the District is managed as wetland habitat. The District's primary function is the delivery of water to the landowners within its boundaries.
Grasslands Ecological Area (GEA)	The wetlands and associated grasslands of the Grassland Resource Conservation District, complemented by state and federal lands, including national wildlife refuges, state wildlife areas, and one state park, comprising over 160,000 acres.
Habitat creation	Construction of habitat that did not previously exist, or would not progress naturally, in a particular location.
Habitat objectives	The amount of protected habitat (usually expressed in acres) needed to meet the population objective and/or combined population objectives for target wildlife species. (See also Conservation objectives.)
Human dimensions of natural resource management	A field of study that incorporates how humans value natural resources into the decision-making processes that influence management, planning and actions.
Hydroperiod	The timing and duration of flooding of wetlands.
Land use trends	The general direction in which management and modification of the natural environment by people is changing.
Long-term goal	As defined in this Plan, the intent of a long-term goal is to identify a future condition that is desired within 100 years.
Management Board, CVJV	Representatives from 19 public and private conservation organizations. These CVJV partners work together at local and regional levels to promote conservation for the benefit of birds, associated wildlife and the people of California.

GLOSSARY

TERM	DEFINITION
Management population	A group of individuals of the same species, that occupies a particular area that has been delineated for management purposes. Depending on the species, a management population may occupy an area that is smaller or larger than the biological population. The management populations for the CVJV Implementation Plan are the planning regions (Sacramento, Yolo-Delta, Suisun, San Joaquin and Tulare) and/or the basins therein. (See also Biological population.)
Management, habitat	The annual maintenance or manipulation of a site to promote desired vegetation and achieve desired habitat performance. Management actions can include application of water, mowing, discing, and maintaining desired water levels.
Member organization	An organization that has membership on the CVJV Management Board.
Migratory Bird Joint Ventures (JVs)	Cooperative, regional partnerships that work to conserve habitat for the benefit of birds, other wildlife, and people. There are twenty-two habitat-based Joint Ventures across North America, each addressing the bird habitat conservation issues found within their geographic area, as well as three species-based Joint Ventures.
Migratory birds	Birds that follow a seasonal movement between their breeding grounds and their wintering grounds. For purposes of regulation, a migratory bird is defined as a bird of a species that belongs to a family or group of species present in the United State as well as Canada, Japan, Mexico, or Russia. Most native bird species (birds naturally occurring in the United States) belong to a protected family and are therefore protected by the Migratory Bird Treaty Act (USFWS 2015b)
Mitigation	A measure designed to counteract an undesirable environmental effect or to make an effect less severe.
Monitoring	The collection and evaluation of data relative to stated project goals and objectives.
Multiple-benefit projects	Projects designed to meet societal needs and enhance ecological function and habitat quality for fish and wildlife.
National Wildlife Refuge (NWR)	A designated area of land and/or water within the National Wildlife Refuge System of the U.S. Fish and Wildlife Service.
National Wildlife Refuge System	The U.S. Fish and Wildlife Service manages the National Wildlife Refuge System. The mission of the Refuge System, as stated in the Refuge System Improvement Act of 1997, is "...to administer a national network of lands and waters for the conservation, management and, where appropriate, restoration of the fish, wildlife and plant resources and their habitats within the United States for the benefit of present and future generations of Americans" (USFWS 2009).
North American Bird Conservation Initiative (NABCI)	A forum of government agencies, private organizations, and bird initiatives helping partners across the continent meet their common bird conservation objectives (NABCI 2016).
North American Waterbird Conservation Plan (NAWCP)	Provides a continental-scale framework for the conservation and management of waterbirds throughout North America, Central America, the Caribbean and western Atlantic, the U.S.-associated Pacific Islands and pelagic waters of the Pacific (Kushlan et al. 2002).
North American Waterfowl Management Plan (NAWMP)	A strategy to restore waterfowl populations through habitat protection, restoration and enhancement using an international conservation partnership approach (NAWMP 2018). Signed in 1986 by the United States and Canada and in 1994 by Mexico.
North American Wetlands Conservation Act (NAWCA)	Public Law 101-233, enacted in 1989, provides funding and administrative direction for implementation of the North American Waterfowl Management Plan and the Tripartite Agreement on wetlands between Canada, U.S. and Mexico. The NAWCA program provides funding for wetlands conservation projects in these countries through a competitive grant program.
Oak savannah	Woodlands with sparse (10% to 40%) tree cover, with oaks (<i>Quercus</i> spp.) as the dominant tree species and primarily grass-dominated understories (Di Gaudio et al. 2017).
Plan life span	The amount of time intended for a planning document to serve as guidance in support of the implementation actions laid out in the document.
Planning horizon	The amount of time an organization looks into the future when preparing a strategic plan. The period covered by a particular plan or planning cycle.

GLOSSARY

TERM	DEFINITION
Planning region	Areas delineated for planning purposes. They can be subjective and informed by ecology, such as natural barriers, gaps in habitat or ecoregional boundaries. In this Plan, planning regions may incorporate multiple basins to reflect the current scientific knowledge and conservation needs of the different bird communities. (See also Basin.)
Population objective	The desired number of individuals of a given wildlife species in a management population. (See also Conservation objectives.)
Postharvest flooding of cropland	A management technique used to break down material left in the field after harvest. Postharvest flooding of rice facilitates residual straw decomposition and provides habitat for waterfowl, waterbirds and shorebirds.
Primary Focus Area of the CVJV Plan	The Central Valley floor, approximately 50 miles wide by 400 miles long; composed of nine hydrologic basins. This is the area where the CVJV focuses most of its efforts. (See also Secondary focus area.)
Protection, habitat	The removal of the threat of loss of bird habitat via fee-title acquisition, conservation easement or agricultural easement from willing sellers. This action does not result in a gain in habitat acreage.
Ramsar Convention on Wetlands of International Importance	An intergovernmental treaty for the conservation and sustainable use of wetlands. It provides the framework for national action and international cooperation for the conservation and wise use of wetlands and their resources. Also known as the Ramsar Convention or the Convention on Wetlands.
Reclamation District	Legal subdivisions within California's Central Valley that are responsible for managing and maintaining the levees, fresh-water channels, sloughs, canals, pumps and other flood protection structures in the area.
Reclamation District 10	Also known as District 10, this area in Yuba County is directly north of the city of Marysville. It was established in 1913 to designate authorities responsible for maintaining the levees in that area to prevent floods. This area includes approximately 12,000 acres of land and 23 miles of levees. The private wetlands within the district and other irrigated fields provide important habitat for waterfowl.
Refuge water supplies, Full Level 2 (L2)	CVPIA water supply requirement based on the average volume of water historically available annually to a managed wetland. This was the existing average water supply delivered to each refuge in the period between 1974 and 1983 (USBR 1989); or two-thirds of the water supply needed for full habitat development for those habitat areas identified in the San Joaquin Action Plan/Kesterson Mitigation Action Plan (USBR et al. 1989). The Bureau of Reclamation provides this water primarily from CVP yield through long-term contractual agreements with the California Department of Fish and Wildlife, the USFWS, and Grassland Water District. The Bureau of Reclamation was to provide this water when CVPIA was enacted in 1992.
Refuge water supplies, Full Level 4 (L4)	CVPIA water supply requirement based on the volume of water per month needed at a managed wetland for optimum habitat management. This is listed for each CVPIA refuge in the "Refuge Water Supply Needs" section of the 1989 Report (USBR 1989); or the full water supply needed for full habitat development for those habitat areas identified in the San Joaquin Action Plan/Kesterson Mitigation Action Plan Report (USBR et al. 1989).
Refuge water supplies, Incremental Level 4 (IL4)	The difference between Full Level 4 and Full Level 2 refuge water supplies.
Resilience, landscape	The ability of a landscape to sustain desired ecological functions, robust native biodiversity, and critical landscape processes over time, under changing conditions, and despite multiple stressors and uncertainties (Standish et al. 2014).
Resource Conservation Districts (RCDs)	Special districts of the State of California, set up to conserve soil and water, control runoff, prevent and control soil erosion, manage watersheds, protect water quality, and develop water storage and distribution. RCDs are locally governed agencies with their own locally appointed or elected, independent boards of directors. RCDs implement projects on public and private lands and educate landowners and the public about resource conservation (California Department of Conservation 2019).
Restoration, habitat	The manipulation of the physical, chemical, or biological characteristics of a site with the goal of returning lost natural functions to degraded native habitat.
Riparian area	The transition area between a body of water (lakes or rivers) and the upland habitat. Usually dependent upon the existence of perennial, intermittent or ephemeral surface or subsurface water drainage.
Scenario planning	A process of visualizing possible future conditions or events, what their consequences or effects would be like, and how to respond to or benefit from them.

GLOSSARY

TERM	DEFINITION
Secondary Focus Area of the CVJV Plan	The area bordering the Central Valley floor and generally following the crest of the mountain ranges that rim the Valley; outside of the CVJV planning regions but within the larger geographic area of the CVJV.
Short-term goal	As defined in this Implementation Plan, a short-term goal is a future condition that is desired within 10 years.
Social science	A major category of academic disciplines, concerned with society and the relationships among individuals within a society. The social sciences include economics, political science, human geography, demography, psychology, sociology, anthropology, archaeology, jurisprudence, history, and linguistics.
Special status species	A universal term used in the scientific community for species that are considered sufficiently rare that they require special consideration and/or protection. These include, but are not limited to, species listed as rare, threatened or endangered by the federal and/or state governments.
Species of concern	A plant or animal species, while not falling under the definition of special status species, that is of management interest by virtue of being a federal trust species such as a migratory bird or an important game species; or, a species that has documented or apparent population declines, small or restricted populations, or dependence on restricted or vulnerable habitats.
Species of Special Concern	A designation by the California Department of Fish and Wildlife. A Species of Special Concern (SSC) is a species, subspecies, or distinct population of an animal native to California that currently satisfies one or more of the following (not necessarily mutually exclusive) criteria: <ul style="list-style-type: none"> • is extirpated from the state or, in the case of birds, is extirpated in its primary season or breeding role; • is listed as federally-, but not state-, threatened or endangered; meets the state definition of threatened or endangered but has not formally been listed;: • is experiencing, or formerly experienced, serious (noncyclical) population declines or range retractions (not reversed) that, if continued or resumed, could qualify it for state status as threatened or endangered; • has naturally small populations exhibiting high susceptibility to risk from any factor(s) that, if realized, could lead to declines that would qualify it for state status as threatened or endangered.
Strategic Habitat Conservation (SHC)	An adaptive management framework that informs decisions about where and how to expend resources for wildlife species, or groups of species, in identified priority areas or regions (landscapes) with particular biological importance.
Strategy	A set of actions with a common focus that work together to achieve specific goals and objectives.
Subtidal habitat	Coastal wetland permanently flooded with tidal water (Mitsch and Gosselink 2000). Technically defined as the area at elevation between Mean Lower Low Water (MLLW) to 18 feet below MLLW. It is synonymous with "Estuarine Wetland - Open Water" and "Estuarine Wetland - Aquatic Bed."
Suisun Resource Conservation District (SRCD)	A 115,000-acre district, established in 1963 as a Special District of the State of California and composed primarily of privately-owned hunting clubs.
Sustainable Groundwater Management Act of 2014 (SGMA)	A state law that establishes a framework for sustainable, local groundwater management. SGMA requires groundwater-dependent regions to halt overdraft and bring basins into balanced levels of pumping and recharge. Upon passage of SGMA, the California Department of Water Resources launched the Sustainable Groundwater Management (SGM) Program to implement the law and provide ongoing support to local agencies around the state.
Tailwater, agricultural	Surface water runoff resulting from crop irrigation.
Threatened species, federal	A plant or animal species listed under the Federal Endangered Species Act of 1973, as amended, that is likely to become an endangered species within the foreseeable future throughout all or a significant portion of its range (USFWS 1998).
Threatened species, state	A plant or animal species listed under the California Endangered Species Act, that is likely to become an endangered species in the foreseeable future in the absence of special protection and management efforts (CDFW 2019).

GLOSSARY

TERM	DEFINITION
TRUEMET	A bioenergetics model developed by waterfowl scientists to estimate waterfowl habitat requirements by comparing food energy needs to food energy supplies (Petrie et al. 2016).
Unprotected land	Any privately-owned land not covered by a perpetual conservation or agricultural easement.
Upland or upland habitat	An area that is not wetlands or aquatic; can include grasslands, scrub-shrub habitat, wetland-associated dry areas, and rangelands. Usually at a higher elevation than wetlands. Some diked, low-elevation or subsided areas, including former agricultural lands that were historically wetlands but are currently dry, may be classified as uplands.
Vital rates	Factors affecting population growth, such as nesting success and duckling survival rates.
Western Hemisphere Shorebird Reserve Network (WHSRN)	An organization dedicated to conserving shorebirds and their habitats through a network of key sites across the Americas. There are three categories of Sites and one of Landscapes, according to their importance for shorebirds: Sites/Landscapes of Hemispheric Importance; Sites of International Importance; and Sites of Regional Importance.
Wetland stipulation	As applied to the CVJV habitat objectives, requires a certain percentage of waterfowl diet resources in a given planning region to come from managed seasonal wetlands, rather than agricultural lands.
Wetlands	Transitional lands between terrestrial and aquatic systems where the water table is usually at or near the surface, or the land is covered by shallow water. Wetlands must have one or more of the following three attributes: 1) At least periodically, the land supports predominantly hydrophytes (plants growing in water or waterlogged soil); 2) the substrate is predominantly undrained hydric soil; and 3) the substrate is saturated with water or covered by shallow water at some time during the growing season of each year. (See also the definitions of different wetland types.)
Wetlands, estuarine	Brackish and saline wetlands associated with estuaries, where salinity due to ocean-derived salts is greater than 0.5%. Estuarine wetlands consist of three main parts: the vegetated marsh plain above the average high tide (estuarine-marsh), the area of open water during an average low tide (estuarine-open water), and the area lacking vegetation that is exposed during the average low tide (estuarine-mudflat). In addition, some estuarine wetlands have submerged aquatic vegetation, such as eel grass, that is partially exposed during the average low tide. Water regime distinguishes tidal from non-tidal wetlands in this category.
Wetlands, historical	Areas where there is evidence that a wetland once existed (USFWS 2018). Generally documented in an historical record of the wetland extent; for example, by historical maps or aerial photographs. More recently, the use of some databases (e.g., areas mapped as having wetland soil types in the soil survey) have been used in attempts to identify these wetlands.
Wetlands, lacustrine	Lacustrine systems (lakes) include wetlands and deepwater habitats with all of the following characteristics: (1) situated in a topographic depression or a dammed river channel; (2) lacking trees, shrubs, persistent emergent vegetation, or emergent mosses or lichens with greater than 30% area coverage; and (3) total area exceeds 8 hectares (20 acres). Lacustrine waters may be tidal or nontidal, but ocean-derived salinity is less than 0.5%.
Wetlands, managed	A given area of land managed for wetland functions and where water is intentionally and actively applied annually through a managed process (USFWS 2000). These diked wetland areas are often managed by manipulating water levels specifically to benefit waterfowl and/or shorebirds.
Wetlands, managed seasonal	Flooded in the fall, with standing water maintained continuously throughout the winter until water is drawn down in the spring (Smith et al. 1994). (Also called moist-soil management areas.)
Wetlands, palustrine	Freshwater tidal wetlands or a range of freshwater nontidal, managed wetlands. The palustrine system includes all nontidal wetlands dominated by trees, shrubs, persistent emergent vegetation, emergent mosses or lichens, and all such wetlands that occur in tidal areas where salinity due to ocean derived salts is below 0.5%. Palustrine wetlands may also include wetlands lacking such vegetation.
Wetlands, permanent	Wetlands that remain flooded throughout the year; also called permanent marshes (Smith et al. 1994).

GLOSSARY

TERM	DEFINITION
Wetlands, reverse-cycle	Reverse-cycle ponds flooded from winter or spring through summer. Also called "summer-flooded seasonal wetlands." Used by waterbirds during the breeding season for nesting, foraging, and roosting. This reverse flooding cycle establishes higher densities of invertebrates that are especially used as a duckling food source than do the typical wet winter/dry summer conditions associated with natural Central Valley flood periods (USACE and NWU 2001).
Wetlands, riverine	Includes all wetlands and deep-water habitats contained within a channel, not including wetlands dominated by trees, shrubs, persistent emergent vegetation, emergent mosses, or lichens.
Wetlands, seasonal	Non-tidal wetlands (either managed or unmanaged) that flood for extended periods, but with no surface water for parts of the year.
Wetlands, semi-permanent	Wetlands (either managed or unmanaged) that flood during the spring and summer but experience a 2- to 6-month dry period each year (Smith et al. 1994).
Wetlands, tidally influenced brackish	Wetlands influenced by the tidal action. Brackish wetlands have more salinity than freshwater, but not as much as seawater. Brackish water may be tidally influenced.
Wildlife Area (WA)	Designation given to certain lands owned or managed by the California Department of Fish and Wildlife as a way of regulating appropriate use. This designation is usually given to land with potential for multiple wildlife-dependent public uses such as waterfowl hunting, fishing or wildlife viewing (CDFW 2015). (Compare with Ecological Reserve.)
Wildlife Management Area (WMA)	A unit of the federal National Wildlife Refuge System where the primary means of protecting wildlife and their habitat is through the acquisition of conservation easements from willing sellers.
Wildlife-friendly agriculture	Agricultural crops (such as rice, corn and wheat), irrigated pasture and alfalfa that are managed to provide important habitat for waterfowl, shorebirds and waterbirds.

LIST OF FIGURES

EXECUTIVE SUMMARY

No figures

SECTION I: THE BIG PICTURE

CHAPTER 1: Introduction to the 2020 CVJV Implementation Plan

No figures

CHAPTER 2: Planning for Conservation Success

Figure 2.1	The elements of Strategic Habitat Conservation.	8
Figure 2.2	Conservation opportunity and water availability interact to drive scenario planning.	8

CHAPTER 3: Conservation Delivery

Figure 3.1	CVJV planning regions, basins, Primary and Secondary Focus Areas and counties.	12
Figure 3.2	Four scenarios representing combinations of conservation opportunity and water availability.	20

SECTION II: SETTING THE STAGE

CHAPTER 4: Environmental, Social and Political Landscape

CHAPTER 4.1: Background

Figure 4.1.1	CVJV planning regions, basins, Primary and Secondary Focus Areas and counties.	28
Figure 4.1.2A	Central Valley wetlands and other significant bird habitat types, Pre-1900s.	29
Figure 4.1.2B	Central Valley wetlands and other significant bird habitat types, 2000s.	30
Figure 4.1.3	Butte Basin.	31
Figure 4.1.4	Colusa Basin.	32
Figure 4.1.5	Sutter Basin.	33
Figure 4.1.6	American Basin.	34
Figure 4.1.7	Yolo Basin.	35
Figure 4.1.8	Suisun Basin.	36
Figure 4.1.9	Delta Basin.	37
Figure 4.1.10	San Joaquin Basin.	38
Figure 4.1.11	Tulare Basin.	39

CHAPTER 4.2: Water

Figure 4.2.1	Semimonthly waterfowl and shorebird water needs from the Sacramento River watershed upstream of the American River confluence.	51
Figure 4.2.2	Semimonthly waterfowl needs from the Sacramento River watershed upstream of the American River confluence: Breakout of water needed to grow rice and winter flood postharvest for habitat.	51
Figure 4.2.3	Semimonthly waterfowl and shorebird water needs in the Delta, San Joaquin and Tulare Basins.	51
Figure 4.2.4	Semimonthly refuge water needs in the Sacramento, San Joaquin and Tulare Basins.	51
Figure 4.2.5	Water supplies acquired for refuges show a declining trend.	52

CHAPTER 4.3: POLICY

No figures

CHAPTER 4.3: CLIMATE

Figure 4.3.1 Predicted 21st century temperature increases in California. 68

CHAPTER 4.3: MULTI-BENEFIT PROJECTS

No figures

CHAPTER 5: HUMAN DIMENSIONS OF BIRD CONSERVATION

Figure 5.1 Strategic Habitat Conservation (SHC) and human dimensions. 83

SECTION III: CONSERVATION OBJECTIVES BY BIRD GROUP

CHAPTER 6: INTRODUCTION TO BIRD CONSERVATION OBJECTIVES

No figures

CHAPTER 7: NON-BREEDING WATERFOWL

Figure 7.1 Central Valley Joint Venture perimeter and Primary Focus Areas divided into five planning regions. 101

Figure 7.2 Duck population energy supply vs. food energy demand for the Central Valley as a whole and for each planning region. 109

Figure 7.3 Goose population energy supply vs. food energy demand for the Central Valley as a whole and for each planning region. 109

Figure 7.4 Duck population energy supply vs. food energy demand for the Central Valley under different model scenarios. 112

Figure 7.5 Goose population energy supply vs. food energy demand under different model scenarios. 112

Figure 7.6 Duck population energy supply vs. food energy demand for the Central Valley when multiple threats are considered in the TRUOMET model. 112

CHAPTER 8: BREEDING WATERFOWL

Figure 8.1 Central Valley Joint Venture perimeter and Primary Focus Area, divided into five planning regions. 128

Figure 8.2 Breeding mallard population estimates for the CVJV Primary Focus Area and five planning regions, 1992-2019. 131

Figure 8.3 Breeding gadwall population estimates for the CVJV Primary Focus Area and five planning regions, 1992-2019. 131

Figure 8.4 Breeding cinnamon teal population estimates for the CVJV Primary Focus Area and five planning regions, 1992-2019. 132

Figure 8.5 Change in available potential waterfowl breeding habitat from 1998 to 2016 in waterfowl breeding population transects surveyed in the Central Valley. 138

CHAPTER 9: NON-BREEDING SHOREBIRDS

Figure 9.1 Central Valley Joint Venture perimeter, Primary Focus Area and planning basins. Also shown is the distribution of potential foraging habitat for non-breeding shorebirds by land cover type. 154

Figure 9.2 Non-breeding shorebird abundance: Current population and long-term objectives. 156

Figure 9.3 Current estimates and short-term (10-year) habitat objectives for shorebird foraging habitat in managed wetlands during the non-breeding season. 156

Figure 9.4 Current estimates of shorebird foraging habitat in flooded agricultural lands. 156

CHAPTER 10: BREEDING SHOREBIRDS

Figure 10.1	Central Valley Joint Venture perimeter and Primary Focus Area, showing estimated current extent of managed wetlands and rice agriculture and estimated historical (pre-1900) extent of wetlands.	168
Figure 10.2	Population status and objectives for breeding shorebirds in the Central Valley.	170

CHAPTER 11: BREEDING AND NON-BREEDING WATERBIRDS

Figure 11.1	Central Valley Joint Venture perimeter and Primary Focus Area, showing the five planning regions.	180
-------------	---	-----

CHAPTER 12: BREEDING RIPARIAN LANDBIRDS

Figure 12.1	Central Valley Joint Venture perimeter and Primary Focus Area, divided into four planning regions. Also shown are estimated areas of historical (pre-1900) and current riparian vegetation.	194
Figure 12.2	Population status and objectives for Central Valley focal riparian bird species.	195

CHAPTER 13: BREEDING GRASSLAND-OAK SAVANNAH LANDBIRDS

Figure 13.1	Central Valley Joint Venture perimeter and Primary and Secondary Focus Areas, showing extent of grassland and oak savannah habitats.	206
Figure 13.2	Population status and objectives for Central Valley grassland and oak savannah bird species.	207

CHAPTER 14: AT-RISK BIRD SPECIES

Figure 14.1	Central Valley Joint Venture perimeter and Primary Focus Area, showing the five planning regions.	219
Figure 14.2	The two-step process to identify at-risk bird species in the Central Valley.	220

LIST OF TABLES

EXECUTIVE SUMMARY

Table ES.1	Habitat conservation objectives (in acres), integrated across all bird groups, by planning region and for the Central Valley as a whole.	iv
------------	--	----

SECTION I: THE BIG PICTURE

CHAPTER 1: Introduction to the 2020 CVJV Implementation Plan

No tables

CHAPTER 2: Planning for Conservation Success

No tables

CHAPTER 3: Conservation Delivery

Table 3.1	Integrated habitat objectives for the Central Valley as a whole.	13
Table 3.2	Integrated habitat objectives for the Sacramento planning region.	13
Table 3.3	Integrated habitat objectives for the Yolo-Delta planning region.	14
Table 3.4	Integrated habitat objectives for the Suisun planning region.	14
Table 3.5	Integrated habitat objectives for the San Joaquin planning region.	14
Table 3.6	Integrated habitat objectives for the Tulare planning region.	14
Table 3.7	Scale at which habitat objectives are established for each bird group.	15
Table 3.8	CVJV Primary Focus Area habitat objectives (acres) for non-breeding waterfowl over the intended life of this Plan.	16
Table 3.9	Managed semi-permanent wetland objectives (acres) for breeding waterfowl in each planning region and for the Central Valley as a whole.	16
Table 3.10	Managed seasonal and semi-permanent wetland objectives (acres) for non-breeding shorebirds.	16
Table 3.11	Managed semi-permanent wetland objectives (acres) for breeding shorebirds in each planning region and for the Central Valley as a whole.	17
Table 3.12	Habitat objectives (acres) for breeding waterbirds in each planning region and for the Central Valley as a whole.	17
Table 3.13	Habitat objectives (acres) for non-breeding waterbirds in each planning region and for the Central Valley as a whole.	17
Table 3.14	Riparian habitat objectives (acres) for breeding riparian landbirds in each planning region and for the Central Valley as a whole.	17
Table 3.15	Habitat objectives (acres) for breeding grassland-oak savannah landbirds in each planning region and for the Central Valley as a whole.	18
Table 3.16	Priority strategies identified by the CVJV to advance the migratory bird conservation objectives outlined in this Plan.	24

SECTION II: SETTING THE STAGE

CHAPTER 4: Environmental, Social and Political Landscape

CHAPTER 4.1: Background

No tables

CHAPTER 4.2: Water

Table 4.2.1	Water deliveries to refuges required by the CVPIA.	45
Table 4.2.2	Water rights and other wetland water sources.	48

Table 4.2.3	Wetland water needs by habitat type (supply needed for full annual cycle).	49
Table 4.2.4	CVPIA Refuges: Average water needs and constraints.	52
Table 4.2.5	Summary of wetland water challenges, opportunities and applicable regions.	59

CHAPTER 4.3: POLICY

No tables

CHAPTER 4.3: CLIMATE

Table 4.3.1	List and conservation status of Central Valley bird taxa classified as vulnerable to the impacts of a shifting climate	72
-------------	--	----

CHAPTER 4.3: MULTI-BENEFIT PROJECTS

No tables

CHAPTER 5: HUMAN DIMENSIONS OF BIRD CONSERVATION

No tables

SECTION III: CONSERVATION OBJECTIVES BY BIRD GROUP

CHAPTER 6: INTRODUCTION TO BIRD CONSERVATION OBJECTIVES

Table 6.1	Relative confidence ranks of conservation objectives for each bird group, and the highest-priority information needed to improve confidence in future planning activities.	96
-----------	--	----

CHAPTER 7: NON-BREEDING WATERFOWL

Table 7.1	Mid-winter duck population objectives for the Central Valley, “stepped down” from the NAWMP.	103
Table 7.2	Percent of the total CVJV duck population objective, and current goose population numbers, assigned to each planning region.	103
Table 7.3	Peak numbers of geese and tundra swans in the Central Valley, based on the average of the last three survey years.	103
Table 7.4	Managed seasonal wetland estimates (acres) for the Central Valley, identified by planning region.	104
Table 7.5	Rice habitat estimates (in acres) for the Central Valley, identified by planning region.	104
Table 7.6	Grain corn habitat estimates (in acres) for the Central Valley, identified by planning region.	104
Table 7.7	Food types, density and true metabolizable energy of important waterfowl foods in the Central Valley.	105
Table 7.8	Relative contribution of wetlands and agriculture (rice and corn) to total duck food energy in the Central Valley.	107
Table 7.9	Ownership and extent (in acres) of Central Valley managed seasonal wetlands, by planning region.	108
Table 7.10	Relative portion of duck foraging habitat and total food energy protected in each planning region.	108
Table 7.11	Summary of scenarios included in the TRUOMET model to examine future threats to duck foraging habitats and food energy supplies in the Central Valley.	111
Table 7.12	Managed seasonal wetlands (in acres) needed to support wintering waterfowl populations at varying levels of agricultural food resource decline in the Sacramento planning region.	114
Table 7.13	Annual Type I wetland enhancement objectives for the Sacramento planning region.	115

Table 7.14	Water needs per month for managed seasonal wetlands in the Sacramento planning region when the total wetland habitat objective of 96,000 acres is met.	115
Table 7.15	Type II wetland enhancement objectives for the Sacramento planning region.	115
Table 7.16	Managed seasonal wetlands (in acres) needed to support wintering waterfowl populations at varying levels of agricultural food resource decline in the Yolo-Delta planning region.	116
Table 7.17	Annual Type I wetland enhancement objectives for the Yolo-Delta planning region.	116
Table 7.18	Water needs per month for managed seasonal wetlands in the Yolo-Delta planning region when the total wetland habitat objective of 40,000 acres is met.	116
Table 7.19	Type II wetland enhancement objectives for the Yolo-Delta planning region.	116
Table 7.20	Water needs per month for managed seasonal wetlands in the Suisun planning region.	117
Table 7.21	Managed seasonal wetland restoration objective (in acres) for the San Joaquin planning region.	118
Table 7.22	Annual Type I wetland enhancement objectives for the San Joaquin planning region.	118
Table 7.23	Water needs per month for managed seasonal wetlands in the San Joaquin planning region when the total wetland habitat objective of 70,875 acres is met.	118
Table 7.24	Type II wetland enhancement objectives for the San Joaquin planning region.	118
Table 7.25	Managed seasonal wetland restoration objective (acres) for the Tulare planning region.	119
Table 7.26	Annual Type I wetland enhancement objectives for the Tulare planning region.	119
Table 7.27	Water needs per month for managed seasonal wetlands in the Tulare planning region when the total wetland habitat objective of 30,000 acres is met.	119
Table 7.28	Type II wetland enhancement objectives for the Tulare planning region.	119
Table 7.29	Conservation objectives for migrating and wintering waterfowl in the Central Valley of California.	120

CHAPTER 8: BREEDING WATERFOWL

Table 8.1	Current and long-term average (LTA) distribution of duck focal species' breeding populations in the Primary Focus Area of the Central Valley.	130
Table 8.2	Population abundance, population objectives and population trends for breeding duck focal species, in the Valley as a whole and by planning region.	133
Table 8.3	Current wetlands of all types, current semi-permanent wetlands and the habitat objectives for semi-permanent wetlands, in the Valley as a whole and by planning region.	144

CHAPTER 9: NON-BREEDING SHOREBIRDS

Table 9.1	Non-breeding shorebird species: Conservation status and Central Valley importance.	153
Table 9.2	Estimated extent of potential foraging habitat for non-breeding shorebirds, by planning basin and land cover type.	157
Table 9.3	Short-term (10-year) and long-term (100-year) habitat objectives for shorebird foraging habitat in managed wetlands during the non-breeding season.	158

CHAPTER 10: BREEDING SHOREBIRDS

Table 10.1	Focal species of breeding shorebirds: National conservation status and importance of the Central Valley for nesting.	167
Table 10.2	Short-term (10-year) and long-term (100-year) habitat objectives for breeding shorebirds: Semi-permanent managed wetlands.	171

CHAPTER 11: BREEDING AND NON-BREEDING WATERBIRDS

Table 11.1	Waterbird focal species: Conservation status and habitat associations during the breeding and non-breeding seasons.	179
Table 11.2	Short-term (10-year) and long-term (100-year) habitat objectives for waterbirds: Year-round or breeding season.	183
Table 11.3	Short-term (10-year) habitat objectives for waterbirds: Non-breeding season.	184
Table 11.4	Estimated total area of crops potentially compatible for waterbird habitat.	184
Table 11.5	Conservation recommendations for waterbird focal species, by key planning regions.	188

CHAPTER 12: BREEDING RIPARIAN LANDBIRDS

Table 12.1	Riparian focal species: Conservation status and habitat associations during the breeding season.	193
Table 12.2	Short-term (10-year) and long-term (100-year) habitat objectives for breeding riparian birds.	197
Table 12.3	Long-term (100-year) average breeding density objectives for each riparian focal species in each planning region.	197

CHAPTER 13: BREEDING GRASSLAND-OAK SAVANNAH LANDBIRDS

Table 13.1	Breeding grassland and oak savannah focal species: Conservation status, life history traits and habitat/vegetation associations.	205
Table 13.2	Short-term (10-year) and long-term (100-year) habitat objectives for breeding grassland and oak savannah landbirds.	209
Table 13.3	Long-term (100-year) breeding density objectives for grassland and oak savannah focal species.	209

CHAPTER 14: AT-RISK BIRD SPECIES

Table 14.1	Bird species at risk in the Central Valley: Conservation status, broad scale habitat affinities and major threats.	217
Table 14.2	Patterns of current distribution of at-risk species during their “season of concern,” across five planning regions of the Central Valley.	221

CENTRAL VALLEY JOINT VENTURE

U.S. Fish and Wildlife Service, Migratory Bird Program
2800 Cottage Way, Suite W-2606
Sacramento, CA 95825

www.centralvalleyjointventure.org

Appendix 7-G
Agreement on Diversion of Water from the Feather River

This page intentionally left blank.

STATE OF CALIFORNIA
THE RESOURCES AGENCY
DEPARTMENT OF WATER RESOURCES

AGREEMENT ON DIVERSION OF WATER
FROM THE FEATHER RIVER

THIS AGREEMENT, made and entered into this 27th
day of *May*, 1969, by and between the State of California,
acting by and through the Department of Water Resources, herein-
after called "State"; Richvale Irrigation District, a public agency,
Biggs-West Gridley Water District, a public agency, Butte Water
District, a public agency, and Sutter Extension Water District, a
public agency, hereinafter collectively referred to as "Districts";

WITNESSETH, That:

WHEREAS, the State is constructing or has constructed
Oroville Dam and Edward Hyatt Powerplant and the Thermalito
Diversion Dam, Power Canal, Forebay, Powerplant, and Afterbay,
which will modify the regimen of the Feather River; and

WHEREAS, the Districts divert water of the Feather River
downstream from the City of Oroville pursuant to rights which are
prior in time and superior in right to the water rights of State;
and

WHEREAS, an Agreement as to the operation of Oroville
Dam and related facilities and diversion of water by the Districts
is desirable;

NOW, THEREFORE, it is agreed as follows:

1. Definitions

When used in this agreement, the following terms have
the meanings hereinafter set forth:

(a) "Afterbay Diversion Structures" means the two structures, gates and control facilities constructed by State in the Thermalito Afterbay pursuant to that certain agreement dated July 6, 1964, entered into by and between the parties hereto.

(b) "Afterbay River Outlet" means the structure, gates and control facilities constructed by State in the Thermalito Afterbay for the release of water into the Feather River.

(c) "Agricultural Use" means any use of water primarily in the production of plant crops or livestock for market, including any use incidental thereto for domestic or stockwatering purposes.

(d) "Districts' Service Area" means the lands included within the boundaries shown on Exhibit A attached hereto and made a part hereof."

(e) "Drought" occurs in any year in which the supply of State project water made available by the State for delivery to contractors under their Water Supply Contracts is less than the total of the annual entitlements of all such contractors for that year and in addition one of the following conditions exists:

(1) The April 1 through July 31 unimpaired runoff to Lake Oroville for the current water year as forecasted by the Department of Water Resources (for inclusion in its Bulletin No. 120, "Water Conditions in California") on February 1 and modified by subsequent monthly reports thereafter as conditions and information warrant, is equal to or less than six hundred thousand (600,000) acre-feet; or

(2) The total accumulated actual deficiencies of unimpaired runoff to Lake Oroville below two million five

hundred (2,500,000) acre-feet in the immediately prior water year or series of successive prior water years each of which had runoff of less than two million five hundred thousand (2,500,000) acre-feet, together with the predicted deficiency, below two million five hundred thousand (2,500,000) acre-feet, for the current water year, exceed four hundred thousand (400,000) acre-feet.

(f) "Flood Control Criteria" means the criteria governing maximum reservoir levels at Lake Oroville in order to provide flood control established pursuant to Article 1 of the contract between the Department and the United States Army Corps of Engineers dated March 8, 1962.

(g) "Irrigation Season" means the period of April 1 through October 31 of each year.

(h) "Joint Manager" means the person, and in his absence his assistant, employed by the Districts to act for them in giving diversion schedules and notices to State and receiving notices and reports to be given by the State to Districts, in accordance with this Agreement.

(i) "Limitation Period" means the period between April 1 and May 31 in all years in which the reduction of deliveries of the annual entitlement for water to be put to Agricultural Use by San Joaquin Water Supply Contractors as imposed by the State in accordance with Article 18(a) of the Water Supply Contracts does not exceed twenty-five percent (25%) or there is no such reduction and the period between March 1 and May 31 in all years in which said percentage reduction exceeds twenty-five percent (25%).

(j) "Pacific" means Pacific Gas and Electric Company and includes its predecessors, successors and subsidiaries.

(k) "San Joaquin Water Supply Contractors" means public agencies located in the San Joaquin Valley that are parties to Water Supply Contracts for delivery of water for Agricultural Use.

(l) "Sutter" means Sutter Extension Water District.

(m) "Sunset" means the Sunset Pumping Plant of Sutter, and includes both the existing plant and additional pumping facilities that may be constructed by Sutter at or near the site of its present pumping plant.

(n) "Tributaries of the Feather River" means all forks of the Feather River and streams flowing into the Feather River or any of its forks, but does not include streams, creeks or channels flowing into the Sacramento River.

(o) "Water Supply Contracts" means the long-term Water Supply Contracts that the State has heretofore entered into with public agencies for supplying water made available by Lake Oroville and other facilities of State, such as the Water Supply Contract entered into with The Metropolitan Water District of Southern California, dated November 4, 1960.

(p) "Water Year" means the period commencing with October 1 of one year and extending through September 30 of the next.

(q) "Western Canal Points of Delivery" means the structures, gates and control facilities constructed by State in the Thermalito Afterbay for delivery of water to Pacific through Western Canal outlets 1 and 2.

2. Water Diversions of the Districts

(a) Except as provided in Article 4 of this Agreement, Districts shall have the right to divert from the Feather River at the Afterbay Diversion Structures each Irrigation Season, five hundred sixty thousand (560,000) acre-feet of the water of the Feather River up to and including the year 1980 and five hundred fifty-five thousand (555,000) acre-feet each Irrigation Season thereafter: Provided, That in any year in which a temporary shortage due to Drought occurs, five hundred fifty-five thousand (555,000) acre-feet to and including 1980 and five hundred fifty thousand (550,000) acre-feet thereafter of the quantity of water Districts shall be entitled to divert under this Article 2(a) shall be reduced by a percentage not to exceed fifty percent (50%) in any one (1) year or a total of one hundred percent (100%) in any series of seven (7) consecutive years, and further not to exceed the percentage for the reduction of deliveries of annual entitlements for water to be put to Agricultural Use in that year by San Joaquin Water Supply Contractors as imposed by the State in that year in accordance with Article 18(a) of the Water Supply Contracts: Provided further, That there shall be added to such reduced amount, and Districts shall be entitled to divert, an additional quantity of water equal to the amount of such reduction but not to exceed thirty-five thousand (35,000) acre-feet. The quantities of water Districts shall be entitled to divert under this Article 2(a) computed in accordance with the foregoing provisions are as set forth in Columns 2 and 3 of Exhibit B attached hereto and made a part hereof.

Diversions under the preceding provisions of this Article 2(a) shall not exceed two hundred fifty thousand (250,000) acre-feet during the Limitation Period of all years in which Drought does not occur and either or both of the following conditions exist:

(1) The storage in Lake Oroville at any time during the Limitation Period equals or exceeds the Flood Control Criteria.

(2) Any release is made from Lake Oroville during the Limitation Period to prevent Lake Oroville from equaling or exceeding the Flood Control Criteria.

During the Limitation Period of all other years in which Drought does not occur, diversions under the preceding provisions of this Article 2(a) shall not exceed two hundred thousand (200,000) acre-feet. During the Limitation Period of all years in which Drought occurs, diversions under the preceding provisions of this Article 2(a) shall not exceed the amount set forth in Column 4 of Exhibit B opposite the percentage of reduction imposed in that year pursuant to Article 18(a) of the Water Supply Contracts on the annual entitlements of water to be put to Agricultural Use by San Joaquin Water Supply Contractors.

The Department shall operate Lake Oroville during the period of April 1 through May 31 to maintain the maximum possible stored water consistent with the Flood Control Criteria and will make no releases prior to June 1 of any year except those provided for in the contract between the Department and Pacific, Southern California Edison Company, and San Diego Gas and Electric Company, dated November 29, 1967.

(b) In addition to the water to be diverted under other provisions of this Article 2, Districts shall have the right to divert and use:

(1) During the period November 1 of each year through March 31 of the next year, such amount of water as Districts determine that they require for reasonable beneficial use but subject to the limitation of diversions during the Limitation Period in years of over twenty-five percent (25%) reduction: Provided, That the State not be estopped from asserting in any judicial or quasi-judicial proceeding that all or any portion of such use is not a reasonable beneficial use.

(2) Pursuant to existing agreements and rights between the Districts and Pacific and agreements that hereafter may be entered into, water to which Pacific is entitled under its contract with State, of which Exhibit C is a copy. State shall not change its said contract with Pacific or permit it to be changed, to diminish in any way the quantity of water Pacific will have available for sale to or use by Districts.

(c) In addition to the water to be diverted under other provisions of this Article 2, Districts shall have the right to divert an additional five thousand (5,000) acre-feet during the Irrigation Season of each year for use as carriage water in the Districts' main canal, provided it is returned to the Feather River above Yuba City as operational spill during the same Irrigation Season. Districts shall measure this return flow and furnish the measurement records to State. State shall be entitled to inspect and test the measuring devices.

(d) In addition to the water to be diverted under other provisions of this Article 2, Sutter shall have the right to divert each Irrigation Season at Sunset and use the following quantities of water:

(1) Sixty-five thousand (65,000) acre-feet in each year in which either the unimpaired runoff to Lake Oroville for the period of April 1 to July 31 as forecasted by the Department of Water Resources (for inclusion in its Bulletin No. 120 "Water Conditions in California") on May 10 is equal to or exceeds one million five hundred thousand (1,500,000) acre-feet, or such predicted runoff when added to the previous years' April 1 to July 31 runoff into Lake Oroville is equal to or exceeds three million (3,000,000) acre-feet.

(2) Fifty thousand (50,000) acre-feet in all other years: Provided, That in any year in which a temporary shortage due to Drought occurs, said amount shall be reduced by a percentage not to exceed fifty percent (50%) in any one (1) year or a total of one hundred percent (100%) in any series of seven (7) consecutive years, and further not to exceed the percentage for the reduction of deliveries of annual entitlements for water to San Joaquin Water Supply Contractors as imposed by the State in that year in accordance with Article 18(a) of the Water Supply Contracts.

Diversions of water during the Limitation Period under the preceding provisions of this Article 2(d) shall not exceed thirty-five percent (35%) of the Irrigation Season entitlement of Article 2(d) water for that year unless releases are made from Lake Oroville during the Limitation Period to prevent Lake

Oroville from equaling or exceeding the Flood Control Criteria or unless the storage in Lake Oroville equals or exceeds the Flood Control Criteria during the Limitation Period.

(e) Notwithstanding the inclusion of March in the Limitation Period, March diversions shall not be included as a part of the amount Districts are entitled to divert during the Irrigation Season.

Any water Districts obtain from Pacific, pursuant to the provisions of Article 2(b) during the Limitation Period shall be added to and increase the amount of water that may be diverted during the Limitation Period by the amount so obtained.

The State shall deliver any portion of the water to which Districts are entitled under this article to the Western Canal Points of Delivery for Pacific and shall deliver any water to which Pacific is entitled to the Districts' Afterbay Diversion Structures and the Afterbay River Outlet for Sutter in accordance with agreements between the Districts and Pacific.

On or before February 15 of each year, State shall furnish Districts a forecast as to whether Drought will occur during that year, as to whether reductions will be imposed, and the percentage of any such reductions, and as to the predicted unimpaired acre-foot runoff into Lake Oroville during the April 1 to July 31 period of that year. An unofficial forecast based on the most recent data available shall be sent to the Districts on or before April 1. An official forecast shall be furnished to Districts on or before April 10. Such forecasts shall be periodically revised as additional data become available: Provided, That the percentage of reduction shall not exceed the percentage set forth in the April 10 forecast.

(f) (1) During the term of this Agreement the Districts shall not divert any water from the Feather River or Tributaries of the Feather River except the water provided for in this Article 2. The Districts shall promptly dismiss Water Right Applications Nos. 13681, 13682, 14919, 14920, 15551, 15552, and 20308, on file with the State Water Resources Control Board and Application No. 2134 before the Federal Power Commission, and shall not file subsequent applications for a project on the Feather River or Tributaries of the Feather River that is the same or similar to the project proposed in said Application No. 2134.

(2) In furtherance of the rights of Districts under the county of origin reservation in the assignment of the State's water rights applications in accordance with Water Code Section 10505, and in furtherance of the rights of Districts under the area of origin law (Water Code Sections 11460-11463), the Districts may obtain project water from the State under the applicable terms of the Standard Provisions for Water Supply Contract approved August 3, 1962, based on the State's prototype water supply contract with The Metropolitan Water District of Southern California, subject, however, to Article 45(h) of the State's Water Supply Contract with the County of Butte dated December 26, 1963. Notwithstanding other provisions of this paragraph, nothing herein contained shall be construed as a waiver by Districts of any rights they may have under the area of origin statutes.

(g) In addition to the water or quantities of water to be diverted under other provisions of this Article 2, Districts may pump and use water obtained from wells located within

Districts' Service Area, and divert, store, and use water from streams and channels other than the Feather River and Tributaries of the Feather River and may divert and use water from drains.

(h) State shall operate Oroville Dam and Lake Oroville and Thermalito Afterbay and related facilities and the Afterbay Diversion Structures to deliver the water provided for in Articles 2(a), 2(b), 2(c), 2(d), 2(e), and Article 3 in accordance with diversion schedules and notices to be given by the Joint Manager.

3. Change in Point of Diversion of Water for Sutter

In addition to the water which may be diverted under Article 2(d) of this Agreement, Sutter may divert at Sunset such portion of the water under Article 2(a) and Article 2(b)(2) as may be designated by the Joint Manager in the diversion schedules and notices to be given under Article 5, instead of diverting it through the Afterbay Diversion Structures. A five percent (5%) reduction shall be applied to any water so designated as diverted under Article 2(a) to determine the quantities thereof that may be diverted at Sunset; no reduction shall be applied to any water purchased by Sutter from Pacific pursuant to Article 2(b)(2).

4. Deliveries During Initial Filling of Lake Oroville

Until storage in Lake Oroville first reaches, or is predicted by State to reach, two million seven hundred thousand (2,700,000) acre-feet, the deliveries of water to the Districts from the Thermalito Afterbay shall be as provided in the letter agreement between Districts, Pacific, and State, dated March 8 1968. Article 2(d) of this Agreement shall not become effective until storage in Lake Oroville first reaches or is predicted by

State to reach two million seven hundred thousand (2,700,000) acre-feet. If storage in Lake Oroville reaches, or is predicted by State to reach, said storage during the period March 1 through October 31 in any year, the rights and obligations of the parties shall be governed by this Agreement for the entire Irrigation Season during that year without regard to the limitation of this article.

5. Diversion Schedules and Notices

(a) On or before October 1 of each year, the Joint Manager shall furnish to State a delivery schedule setting forth the quantities of water to be delivered to the Districts weekly during the next year through the Afterbay Diversion Structures. Districts may revise this schedule on or about April 15 after State has furnished Districts with State's forecast of any deficiency.

(b) The Joint Manager shall submit a weekly schedule not later than 1:00 p.m. on Wednesday preceding the week in which the schedule is to take effect. Such schedule shall set forth the quantities in total acre-feet per week and rates of flow in cubic feet per second to be delivered during the week to the Afterbay Diversion Structures, to Sunset pursuant to Article 2(d), and to the Afterbay River Outlet for delivery to Sutter pursuant to Article 3. For purposes of this section, the week shall be considered as beginning at 12:01 a.m. each Sunday and continuing until 12:01 a.m. the following Sunday.

(c) The Joint Manager shall notify State no later than 4:00 p.m. each day of the rates of flow in cubic feet per second to be delivered to or for Districts during the twenty-four

(24) hour period commencing at 8:00 a.m. on the following day.

(d) Revisions in rates of flow not in excess of fifty (50) cubic feet per second shall be made by State within three (3) hours of any such revised request from Districts. Revisions in rates of flow of more than fifty (50) cubic feet per second, but less than two hundred (200) cubic feet per second, shall be made by State within twelve (12) hours of any such revised request from Districts. Revisions in rates of flow in excess of two hundred (200) cubic feet per second shall be made by State within twenty-four (24) hours of any such revised request from Districts.

Until such time as the Afterbay Diversion Structures are controlled from State's Control Center, requests for revision of rates of flow shall be made between the hours of 8:00 a.m. and 3:00 p.m. After the Afterbay Diversion Structures are controlled from State's Control Center, such requests may be made at any time.

Any request for revision may be made by telephone, or by such other means as may be agreed upon by the parties. State shall at all times make such changes as requested as soon as practicable, but in no event later than the time limits established herein.

Requests for revisions in the rate of flow shall be given to State's representatives located at State's Oroville headquarters. Initially, State's representatives shall be the Chief Operator, Monday through Friday, except state holidays, and at all other times, the operator located at State's Control Center.

(e) The water deemed delivered to Districts in any week under Articles 2(a), 2(b), 2(c), 2(d), 2(e), and Article 3

shall be the quantity of such water diverted by Districts during that week but subject to all of the following:

(1) The amount deemed delivered shall not be less than the amount ordered for that week in the Joint Manager's weekly schedule as it may be reduced pursuant to his daily notices given under Article 5(c), however, that portion of said reductions that exceeds (1) in any one day 400 acre-feet multiplied by the number of days or fractional day in the week remaining at the time the reduction is ordered to take effect; or (2) in any one week 2800 acre-feet will be deemed delivered to the extent it cannot be conserved by State in Lake Oroville and Thermalito Afterbay but to the extent such excess can be conserved by State in said facilities it shall not be deemed delivered.

(2) Notwithstanding the provisions of the next preceding paragraph, in any week during which State makes releases from Lake Oroville to prevent Lake Oroville from equaling or exceeding the Flood Control Criteria the water deemed delivered through the Afterbay Diversion Structures shall be the quantity of water delivered to the Districts during that week through such structures but not exceeding the amount ordered to be delivered through such structures by the Joint Manager pursuant to the weekly schedule as revised by his daily notices given under Article 5(c).

(3) Water received by Districts in excess of the rate of flow specified in the Joint Manager's daily notice given under Article 5(c) will not be deemed delivered except that the combined flow of water through the Afterbay Diversion Structures, up to 2 percent or 20 cubic feet per second (whichever is greater) in excess of the rate of flow so specified will be deemed delivered.

(4) Water not received by Districts due to the failure of State to comply with the Joint Manager's weekly schedule as revised by his daily notices given under Article 5(c), will not be deemed delivered.

In the event of an emergency threatening the destruction of life or property, the Joint Manager may by telephone order an immediate reduction in the releases of water through the Afterbay Diversion Structures and such changes shall be made immediately by State, or in the event of its failure to do so, the Joint Manager may change the setting of the Afterbay Diversion Structures. In such event, the Districts will be deemed to have received the full flow set forth in the latest current effective diversion schedule or notice for a period not to exceed twelve (12) hours after the reduction is made, but only to the extent that it cannot be conserved by State.

Consistent with its other requirements and contractual obligations, State will endeavor to conserve in the Oroville-Thermalito facilities, water scheduled but which Districts are unable to use during any week.

The quantity of water State is obligated to deliver to Districts during any week under Article 2(a), 2(b), 2(c), 2(d), 2(e) and Article 3 shall not exceed by more than 400 acre-feet in any day the daily quantity of water set forth in the schedule of the Joint Manager for that week: Provided, That the limitation shall not apply in any week during which the State makes releases from Lake Oroville to prevent Lake Oroville from equaling or exceeding the Flood Control Criteria.

To the extent that State can do so consistent with its other requirements and contractual obligations, the State will make available any additional quantities of water Districts may request in excess of the quantity set forth in the schedule of the Joint Manager for that week.

(f) For the purpose of ascertaining if mutually agreeable changes can be made, the terms of this Article 5 shall be reviewed by the parties after the first Irrigation Season during which Afterbay Diversion Structures are controlled from State's Control Center, and thereafter on the request of any party but not more frequently than once every five years.

6. Responsibility for Distribution of Water and Liability of State

Districts shall be responsible for the distribution of water diverted by them after it passes through the Afterbay Diversion Structures and the pumping facilities at Sunset.

Except as otherwise herein provided, neither the State nor any of its officers, agents, or employees shall be liable for the control, carriage, handling, use, disposal, or distribution of water diverted under the terms of this Agreement after it passes into Districts' canal system through the Afterbay Diversion Structures or the pumping facilities at Sunset.

State shall be solely responsible for maintaining a sufficient flow of water in the Feather River downstream from the Thermalito Diversion Dam to supply water diverted by others under rights superior to those of State or Districts.

This Agreement does not relieve State or its officers, agents or employees from liability to or from damages to Districts

or third parties arising out of failure of State at any time to comply with this Agreement or the diversion schedules or notices given by Joint Manager pursuant hereto or from injuries to crops or production of crops due to reduction in temperature of water available to Districts during any portion of any Irrigation Season or seasons as a result of water released from Lake Oroville being colder than water that would have been available in the Feather River for diversion by Districts if Oroville Dam had not been constructed. Nothing in this Agreement shall be construed as an admission by State that a reduction in the temperature of water available to Districts will in fact cause injury to crops or production of crops.

7. Districts Not to Transfer Water

Subject to the provisions of Article 2(e) Districts shall not assign or sell the right to use any of the water to be provided for their use under this Agreement, nor deliver any such water to any person or entity located outside Districts' Service Area as shown on Exhibit A without the prior written consent of State. This provision is not violated by reason of the fact that some drain water will escape Districts' Service Area and be used outside such area by third parties or by reason of the fact that water is supplied to flush industrial wastes that may flow outside the service area.

8. Measurement of Diversions

State shall measure diversions into Districts' canal system through the Afterbay Diversion Structures and telephone to the Joint Manager preliminary records of such measurements prior to Wednesday of each week covering the preceding calendar week

and confirm them in writing mailed to the Joint Manager not later than the fifteenth day of each month. The records delivered shall show quantities and average flows each day. Districts shall have the right to inspect and test such measuring devices and obtain data as to water deliveries to Districts at their expense as frequently as they deem necessary. Districts may, at their expense, install equipment at and connected with the Afterbay Diversion Structures and the measuring devices downstream therefrom to transmit, electrically or electronically, information on water deliveries, flows, guage heights, and gate openings: Provided, That the type of equipment and method of installation shall be subject to the approval of the State.

Sutter shall measure all water diverted at Sunset and through the Joint Manager shall telephone to State preliminary records of such measurements prior to Wednesday of each week covering the preceding calendar week and confirm them in writing mailed to State not later than the fifteenth day of each month. The records delivered shall show quantities and average flows each day. State shall have the right to inspect and test the measuring devices and ratings of the pumps at State's expense as frequently as State deems necessary.

9. Term of Agreement

This Agreement between State and Districts takes effect as of the date hereof and shall remain in full force and effect until terminated by the mutual consent of the parties or as provided for in Article 11(c): Provided, That this Agreement shall not be effective until Districts and Pacific have entered into an agreement which, during the period this Agreement and

Exhibit C are in full force and effect and not modified in any way or by any means unacceptable to Pacific or Districts, or any of Districts, has the effect of modifying that certain decree dated December 14, 1924, in Civil Action No. 2360 in the Superior Court of the State of California in and for the County of Sutter to permit the full performance of this Agreement.

10. Prior Agreements

During the term of this Agreement the "Agreement Concerning the Operation of Antelope Valley Unit" dated January 21, 1964, between the State and the Districts shall not be effective insofar as it restricts the operation of the Antelope Valley Unit by the State.

To the extent that provisions in the agreement between the State and the Districts dated July 6, 1964, are necessarily inconsistent with this Agreement, they shall be superseded by this Agreement. However, State shall not be relieved of obligations under said July 6, 1964, agreement not necessarily inconsistent, including, without limiting the generality of the foregoing, its obligation to design, construct, maintain and operate the facilities therein referred to and any necessary fish screens and facilities in conjunction with the construction and use of the structures provided for under paragraph 1 of said agreement and to petition to include the real property referred to in paragraph 10 of said agreement in the Districts and to support the efforts of Districts to accomplish such inclusions.

11. Water Right Controversies

(a) Districts do not surrender, modify or terminate any of their rights to divert water or change the priority of

their rights, except for the change in point of diversion agreed to in their said July 6, 1964, agreement with the State and except as to the dismissal of certain applications for the storage and diversion of water on the Middle Fork of the Feather River and for generation of electricity. Districts will protect and defend their rights to divert water from the Feather River, including the protesting of applications to appropriate water that are adverse to the rights of Districts, the prosecution of such protests before the State Water Resources Control Board and other administrative agencies, and the defense of such water rights in courts:

Provided, That the failure of Districts to protest an application or otherwise defend their water rights shall not be a default under this Agreement, unless Districts fail to protest an application or otherwise defend their water rights after having been specifically requested to do so by the State, as to the specific application or court proceeding, in time for protests or defenses to be made.

(b) Water diverted by Districts under this Agreement shall be deemed diverted under Districts' water rights.

(c) All parties agree to join in resisting any attack upon this Agreement or any of its provisions by judicial, administrative, or any other bodies. If this Agreement or any part thereof is decreed unenforceable or directly or indirectly modified in any respect other than by mutual agreement, the party whose interests are adversely affected shall have the option of terminating this Agreement, in which event all rights and privileges prevailing prior to the execution of this Agreement, the agreement between Districts and Pacific referred to in Article 9 hereof,

and the agreement between State and Pacific, a copy of which is attached as Exhibit C, shall be restored, and State shall operate the Afterbay Diversion Structures to supply the yield of the rights of Districts to the same extent as if Lake Oroville were not in existence and this Agreement and the agreements between State and Pacific had not been entered into.

Nothing in this Agreement shall be construed as an admission or consent by Districts that this Agreement or any part thereof is unenforceable or may be modified either directly or indirectly by judicial, administrative, legislative or other action except by mutual agreement of the parties.

12. Inspection of Records

The proper officers or agents of either party shall have full and free access at all reasonable times to the official records of the other party insofar as the same pertain to the matters and things provided for in this Agreement with the right at any time during office hours to make copies of such records.

13. Successors and Assigns Bound

This Agreement shall be binding upon and inure to the benefit of the successors and assigns of the respective parties to it.

14. Waivers

Any waiver at any time by any party to this Agreement of its rights with respect to a default or any other matter arising in connection with this Agreement shall not be deemed to be a waiver with respect to any subsequent default or matter.

15. Notices

Except as otherwise herein expressly provided, all notices that are required either expressly or by implication to be given by one party to the other under this Agreement shall be signed for the State by its contracting officer, and for the Districts by their Joint Manager; shall be deemed to have been given at the time of delivery if delivered personally or twenty-four (24) hours after deposit in the mail if enclosed in a properly addressed envelope and deposited in a United States Post Office for delivery with postage prepaid; and unless and until formally notified otherwise shall be addressed to the State and the Districts at their addresses as shown on the signature page of this Agreement.

16. Opinions and Determinations

Where this Agreement calls for determinations, forecasts, or decisions to be made by the Department of Water Resources, or the State, they shall not be made capriciously, arbitrarily or unreasonably and Districts reserve the right to relief from and appropriate adjustment for any such arbitrary, capricious or unreasonable determination, forecast or decision.

IN WITNESS WHEREOF, this Agreement has been executed
by the parties hereto as of the date first above written.

Approved as to legal form and
sufficiency:

STATE OF CALIFORNIA
DEPARTMENT OF WATER RESOURCES

For By *D. I. [Signature]*
Chief Counsel
Department of Water Resources

By *W. [Signature]*
Director
P. O. Box 388
Sacramento, California

RICHVALE IRRIGATION DISTRICT

BUTTE WATER DISTRICT

By *Glen P. Harris*
President

By *Walter G. Little*
President

By *Lloyd E. Horn*
Secretary

By *Faust [Signature]*
Secretary

BIGGS-WEST GRIDLEY WATER
DISTRICT

SUTTER EXTENSION WATER DISTRICT

By *James E. [Signature]*
President

By *Albert [Signature]*
President

By *W.C. Jensen*
Secretary

By *David F. [Signature]*
Secretary

Address of Districts:

Joint Water Districts
P. O. Box 425
Gridley, California 95948

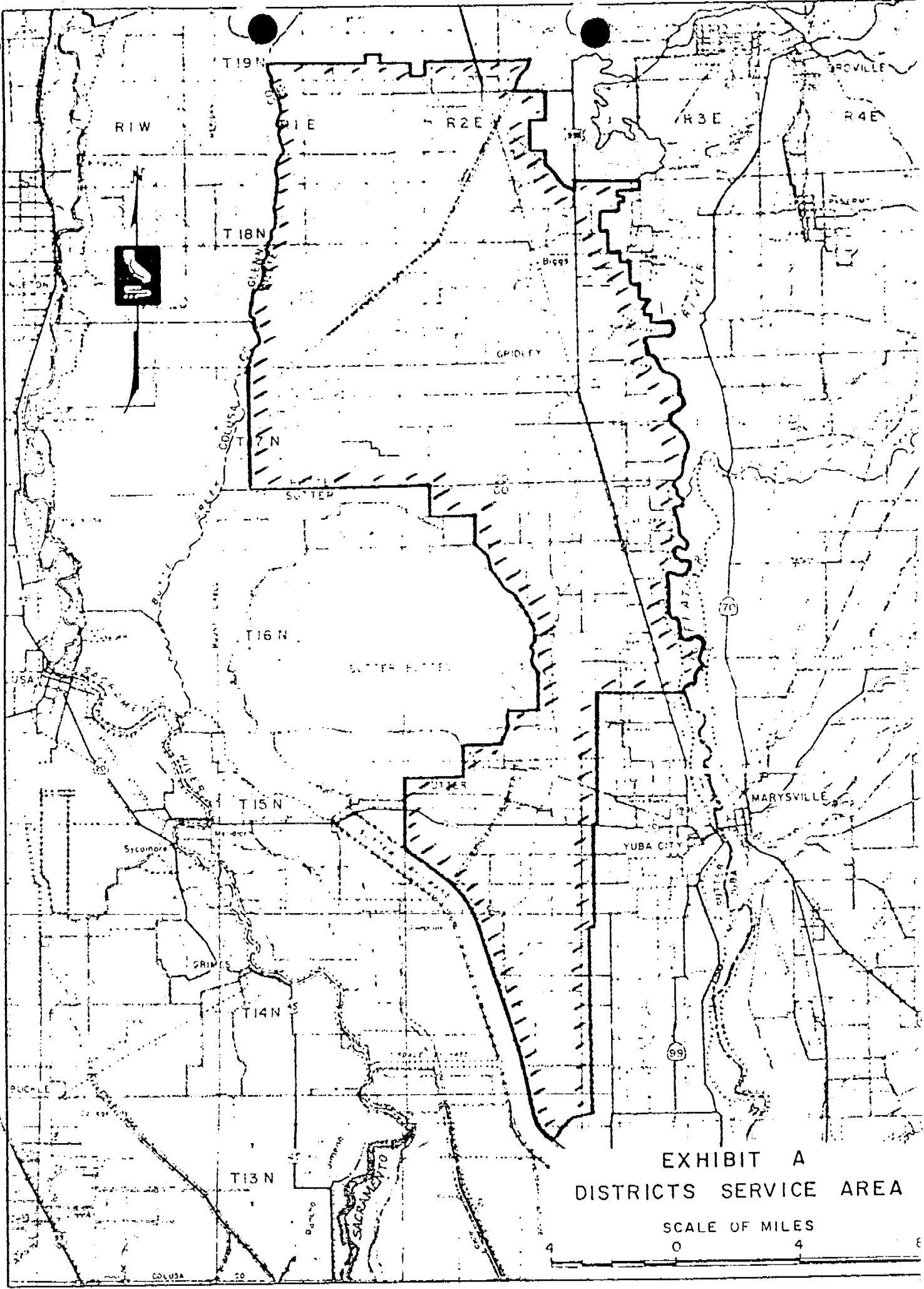



EXHIBIT A
DISTRICTS SERVICE AREA

SCALE OF MILES
0 4 8

EXHIBIT B
 Limitations on Diversions of Article 2a Water

<u>Column 1</u>	<u>Column 2</u>	<u>Column 3</u>	<u>Column 4</u>	<u>Column 5</u>
% of Reduction	During Irrigation Season in Years Prior to 1981	During Irrigation Season after the Year 1980	During Limitation Period	Limitation Period
0	560,000	555,000	200,000	Apr 1 to May 31
1	560,000	555,000	197,200	↑ ↓
2	560,000	555,000	194,400	
3	560,000	555,000	191,600	
4	560,000	555,000	188,800	
5	560,000	555,000	186,000	
6	560,000	555,000	184,300	
7	556,150	551,500	182,600	
8	550,600	546,000	180,900	
9	545,050	540,500	179,200	
10	539,500	535,000	177,500	
11	533,950	529,500	175,800	
12	528,400	524,000	174,100	
13	522,850	518,500	172,400	
14	517,300	513,000	170,700	
15	511,750	507,500	169,000	
16	506,200	502,000	167,300	
17	500,650	496,500	165,600	
18	495,100	491,000	163,900	
19	489,550	485,500	162,200	
20	484,000	480,000	160,500	
21	478,450	474,500	158,800	
22	472,900	469,000	157,100	
23	467,350	463,500	155,400	
24	461,800	458,000	153,700	
25	456,250	452,500	152,000	
26	450,700	447,000	150,320	
27	445,150	441,500	148,640	
28	439,600	436,000	146,960	
29	434,050	430,500	145,280	
30	428,500	425,000	143,600	
31	422,950	419,500	141,920	
32	417,400	414,000	140,240	
33	411,850	408,500	138,560	
34	406,300	403,000	136,880	
35	400,750	397,500	135,200	
36	395,200	392,000	133,520	
37	389,650	386,500	131,840	
38	384,100	381,000	130,160	
39	378,550	375,500	128,480	
40	373,000	370,000	126,800	
41	367,450	364,500	125,120	Mar 1 to May 31

<u>Column 1</u>	<u>Column 2</u>	<u>Column 3</u>	<u>Column 4</u>	<u>Column 5</u>	
% of Reduction	During Irrigation Season in Years Prior to 1981	During Irrigation Season after the Year 1980	During Limitation Period	Limitation Period	
42	361,900	359,000	123,440	Mar 1 to May 3	
43	356,350	353,500	121,760		
44	350,800	348,000	120,080		
45	345,250	342,500	118,400		
46	339,700	337,000	116,720		
47	334,150	331,500	115,040		
48	328,600	326,000	113,360		
49	323,050	320,500	111,680		
50	317,500	315,000	110,000		
					Mar 1 to May 3

This page intentionally left blank.



801 T Street
Sacramento, CA 95811
916.999.8700
woodardcurran.com



In Association with

